

sale@technobearing.ru

TECHNOBEARING.RU

8 (800) 700-72-07

ZWZ

Bearing Integral Catalogue



WAFANGDIAN BEARING GROUP CORP., LTD.

sale@technobearing.ru

TECHNOBEARING.RU

8 (800) 700-72-07

Catalogue Content

The Structure and Characteristics of Rolling Bearings	1
The Structure of Rolling Bearings	1
The Classification of Rolling Bearings	1
The Characteristics of Rolling Bearings	3
<hr/>	
The System of Bearing Code	4
The Basic Bearing Code	4
The illustration to the Change of Dimension, Structure and Type	10
The illustration to the Change of Technical Requirements	10
Prefix of Bearing and Bearing Components	10
Suffix of Bearing and Bearing Components	22
The illustration to the Sequence of Bearing Code	47
Case of the Combination of Bearing Basic Code and Suffix	48
The Description for the Drawn up of Current Bearing Code	48
Accessories of Rolling bearing	50
Draw up method of Special Type Bearing	52
<hr/>	
The Selection of Bearing	54
The Operating Conditions and Environment Conditions of Bearing	54
The Selection of Bearing Type	54
The Selection of Bearing Collocation	56
The Specification of Bearing Collocation	58
The Selection of Bearing Dimension	61
Bearing Life	61
Basic Dynamic Load Rating	62
Basic Life Rating	62
The Modified Basic Dynamic Load Rating Based on Temperature and Stabilizing Treatment of Bearing	63
Correction of Life Rating	64
The Bearing Life Required by the Machinery	65
Equivalent Dynamic Load	66
Basic Static Load Rating	70
Equivalent Static Load	70
Safety Factors	71

The Preload of Bearing	72
Purpose of Bearing Preload	72
Types of Preload	72
Positional Preload	72
Constant Pressure Preload	72

Bearing Data	73
Main Bearing Dimensions	73
Bearing Tolerance	74
Bearing Clearance	106
Bearing Material	117

The Limit Speed of Bearing	119
The Determination Method of Rolling Bearing's Limit Speed	119
The Limit Speed of Rolling Bearing in Actual Application	122
Correction of Limit Speed	123
The Limit Speed of the Bearing with Sealing Ring	124
Precautions of high speed rotation	124

Friction and Temperature Rise of Bearing	125
Friction	125
Approximate Calculation to Friction Torque	125
Temperature Rise	125

Fit of Bearing	126
The Purpose of Fit	126
The Selection of Fit	126

Catalogue Content

Lubrication	130
The purpose of Lubrication	130
The effect of Lubrication	130
Methods of Lubrication	130
Oil Lubrication	130
Grease Lubrication	132
The Selection Rules of Oil Lubrication	133
The Selection Rules of Grease Lubrication	134
<hr/>	
The Application of Bearing	137
Precautions for use	137
The Storage of Bearing	137
The Mounting of Bearing	137
The Dismounting of Bearing	141
The Maintenance of Bearing	141
Identification of Bearing Problems	142
The Damages and Solutions of Bearing	143
<hr/>	
Bearing Appendix	1067
Concise comparison of New and Old Bearing Code System	1067
Inch-mm Conversion Table	1081
Basic Tolerance IT	1086
Viscosity Conversion Table	1087
Rockwell, Vickers and Brinell hardness Conversion Table	1089
Conversion Table of Leeb and Rockwell Hardness	1092

Bearing dimensional Table	
Deep Groove Ball Bearing	147
Angular Contact Ball Bearing	241
Self-aligning Ball Bearing	323
Cylindrical Roller Bearing	333
Spherical roller Bearing	535
Tapered Roller Bearing	647
Thrust Ball Bearing	849
Thrust Roller Bearing	887
Railway Bearing	933
Slewing Bearing	977
Bearing Appendix	1067

Rolling Bearings

The Structure and Characteristics of Rolling Bearings

The Structures of Rolling Bearings

A rolling bearing normally consists of rings (inner ring and outer ring), rolling elements and cage. Between inner ring (or shaft washer) and outer ring (or housing washer) have a number of rolling elements between them, which are held by the cage to keep the rolling element with certain distance to ensure smooth rolling.

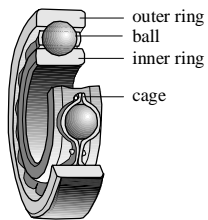

(Deep groove ball bearing)

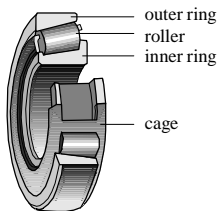

(Tapered roller bearing)

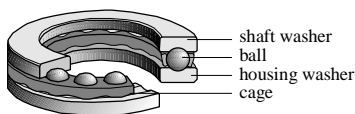

(Thrust ball bearing)

Figure 1. Structure example

Rings (inner ring and outer ring)

The surface which carrying bearing load, is fit for the raceway of rolling element. The raceway appears groove shape, generally the cross section are the arch type, the diameter is slightly larger than ball diameter. Generally, the inner ring and outer ring work with shaft and housing respectively. The inner ring and outer ring of thrust bearing are also called the shaft washer and housing washer respectively.

Rolling Elements

Rolling elements have two types, one of which is balls and the other one is rollers. The rollers can be cylindrical rollers, needle rollers, tapered rollers and spherical rollers and etc.

Cage

The cage is applied to embrace the rolling elements partially to ensure a distance between the two neighbor rollers in the circumferential direction, and moving along with the rollers. The cage can be pressed cages, solid machined cages or engineering plastic cages. Comparing with the full complement (balls or rollers) bearings, the bearings with cages have less friction and are suitable for the high-speed rotation condition.

The Classification of Rolling Bearings

Based on the different contact angles, rolling elements can be divided into radial bearings and thrust bearings. Or according to the structures of the rolling elements and rings, they can be classified into deep groove ball bearings, self-aligning ball bearings, angular contact ball bearings, thrust ball bearings, cylindrical roller bearings, needle roller bearings, self-aligning roller bearings, tapered roller bearings, thrust spherical roller bearings and so on. According to the number of rows of rolling elements, it can also be divided into single row, double row and multi-row (e.g. three-row, four-row) bearings. For general classification of bearings, refer to Figure 2.

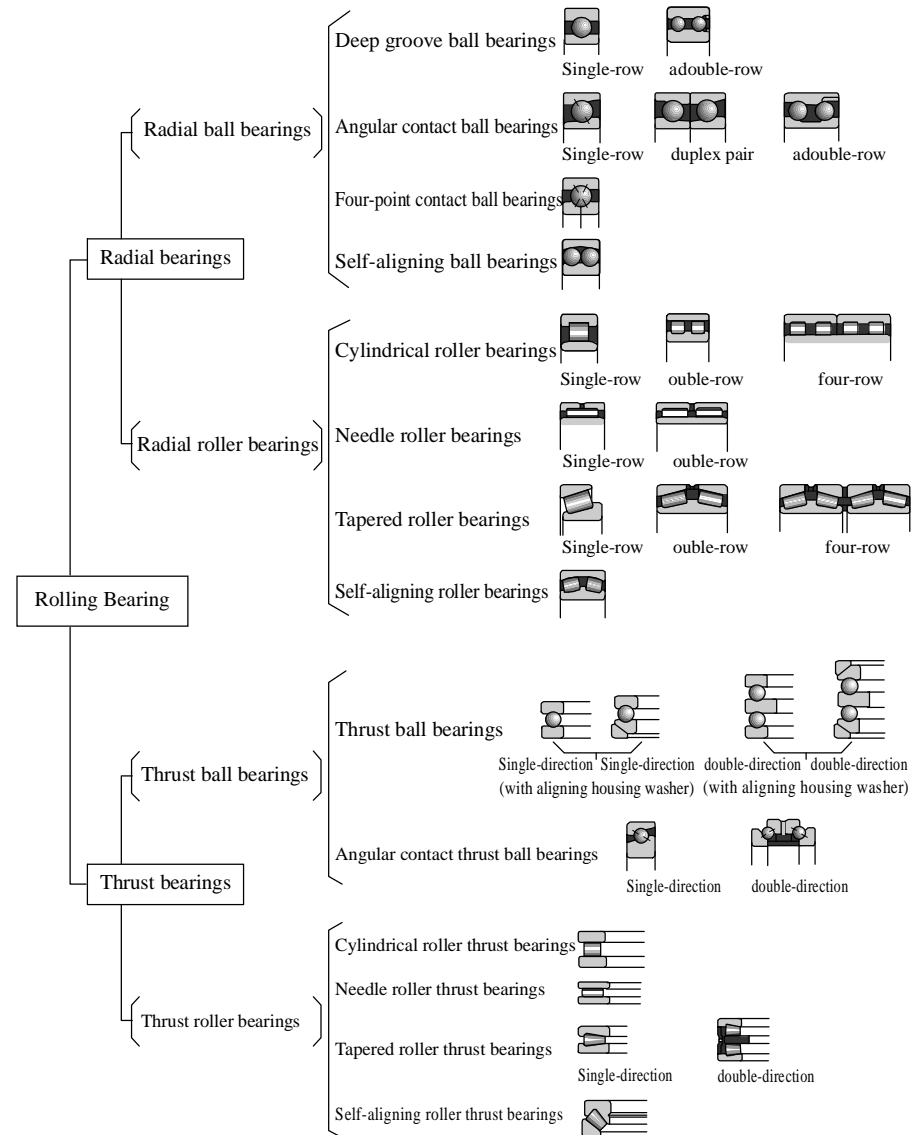

Figure 2. The bearing classification

The characteristics of Rolling Bearings

1. Low starting friction coefficient, flexible while starting .
2. Good interchangeable property, easy for maintain and replacement.
3. Lubricated easily and less lubricant consumed, easy to seal and maintain .
4. Most of bearings can carry the axial and radial load simultaneously.
5. Applied easily under high or low temperature condition.
6. Bearing rigidity can be reinforced by applying preload.
7. Relative small radial clearance, high rotation precision.

The System of Bearing Code

The Basic Bearing Code

The standard bearings

Each standard bearing, designed by ZWZ, has a basic code, which usually consists of three, four or five digitals, or combined with letters and digitals.

The meaning of digitals (or letters and digitals) is as below:

--The initial digital, letter or letter group indicates bearing type.

--The second and the third digital indicates the dimensional series. The second digital stands for the width (height) series, the third

digital stands for the diameter series.

--The last two digitals of the basic bearing code multiplied by 5 will be the bore diameter in millimeter.

Under certain cases, the digital standing for the types of bearing or the first digital standing for the dimension series are default. The default digitals have been listed with the brackets in

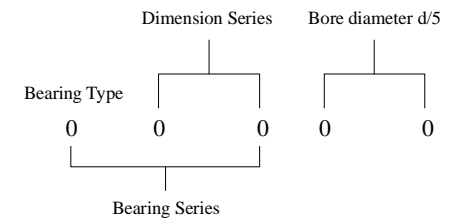

Table 1

(0)32	1(0)2	223	302	4(2)2	510	(6)(0)2	719	811
(0)33	(1)22	213	303	4(2)3	511	(6)(0)3	7(1)0	812
(0)40	1(0)3	232	310		512	6(0)2	7(0)2	822
(0)49	(1)23	222	313		513	6(0)3	7(0)3	823
		241	318		514	6(0)4	7(0)4	871
		231	319			6(1)0	2344	872
		240	320		522	16(0)0	2347	874
		230	322		523	617	2349	893
		249	323		524	618		894
		239	329			619	5600	
		248	330		532	637	7600	
		238	331		533			
		202	332		534			
		203						
		204	3500		542			
			3700		543			
		294	3800		544			
		293						
		292						

Rolling Bearings

Table 1 (Continued)

911	N10	NUP (0) 2	UC2	QJ10
912	N (0) 2	NUP22	UC3	QJ18
913	N22	NUP (0) 3		QJ19
914	N (0) 3	NUP23	UEL2	QJ29
	N23		UEL3	QJ39
991	N (0) 4	NF (0) 2		QJ2
992		NF (0) 3	UK2	QJ3
993	NU10	NF23	UK3	
994	NU (0) 2			QJF10
995	NU22	NN30		QJF18
	NU (0) 3	NNU49		QJF19
922	NU23			QJF29
923				QJF39
924	NJ (0) 4			QJF2
	NJ (0) 2			QJF3
	NJ22			
	NJ (0) 3			
	NJ23			
	NJ (0) 4			

The code of bearing types

- 0- Double-row angular contact ball bearing
- 1- Self-aligning ball bearing
- 2- Self-aligning roller bearing and thrust self-aligning roller bearing
- 3- Tapered roller bearing
- 4- Double-row deep groove ball bearing
- 5- Thrust ball bearing
- 6- Deep groove ball bearing
- 7- Angular contact ball bearing
- 8- Cylindrical roller thrust bearing
- 9- Tapered roller thrust bearing

The non-standard bearings

In recent year, due to the types of non-standard bearings increasing gradually, there are some unique, special and new products appears in the market, in order to let these product to compete in the global market, provide convenience for sell the products in domestic market, it is necessary to formulate the code system. The non-standard bearing code is consists of basic code and prefix & suffix code.

N- Cylindrical roller bearing

If there are one or more letters followed "N", the code will represents rib structure or types of the bearings. such as NJ, NU, NUP, NN stands for double-row or multi-row cylindrical roller bearing.

Needle roller bearing

NA or NK is normally used to express needle roller bearings.

U- Spherical outside surface ball bearing

QJ- Four-point contact ball bearing

The basic code of the non-standard bearing consists of two parts, one is the bearing type code and the other is Indication of dimensions for bearing basic dimension .

The indication of of dimensions according to the two methods as follows.

- 1. Non-standard bearing represents by dimension series number a) Standard bore

diameter and non-standard outside diameter or width (height)

The non-standard outside diameter or width (height) should be indicated by a letter following basic bearing code of a bearing, which has a most similar diameter series or width (height

series) with this non-standard bearing. This bearing can be determined through comparing the standard OD dimension or width (height) dimension, or following the extensive rule of the standard boundary dimension. Please refer to Table 1.

b) Non-standard bore diameter, outside diameter and width

The non-standard bore diameter, outside diameter and width (height) should be indicated by indefinite series code because the comparison with standard dimension or, extensive rule of the standard boundary dimension is not available. Please refer to Table 2 for the indefinite series code of ZWZ bearings.

Table 1

Letter	Meaning
X1	Non-standard outside diameter
X2	Non-standard width (height)
X3	Non-standard outside diameter and width (height) (Standard bore diameter)

Table 2

Type of Bearing	Basic Bearing Code
Double-row angular contact ball bearing	4600
Self-aligning ball bearing	1600
Spherical roller bearing	20600
Tapered roller bearing	30600
Double-row tapered roller bearing with double-raceway cup	350600
Double-row tapered roller bearing with double-raceway cone	370600
Four-row tapered roller bearing	380600
Double-row deep groove ball bearing	40600
Thrust ball bearing	51700
Double-direction thrust ball bearing	52700
Deep groove ball bearing	6600
Angular contact ball bearing	7600
Four-point contact ball bearing (split inner bearing race)	QJ600
Four-point contact ball bearing (split outer bearing race)	QJF600
Thrust angular-contact ball bearing	561700
Double-direction angular contact ball thrust bearing	232700
Cylindrical roller thrust bearing	81700
Double-direction cylindrical roller thrust bearing	82700
Tapered roller thrust bearing	91700
Double-direction tapered roller thrust bearing	92700
Cylindrical roller bearing	N600, NU600, NJ600, NF600, NUP600, NN600, NNU600
Self-aligning roller thrust bearing	21700

Note: "00" stands for any proper bore diameter code of bearing.

Rolling Bearings

2. Non-standard bearing indicated by bore diameter code, please refer to Table 3 for the bore diameter code of the non-standard bearing.

Table 3

Inner diameter	Indication method
Standard dimension	Reference to the present standard.
Non-standard dimension	<p>Bore diameter is indicated by the quotient divided by 5 if this bore diameter is smaller than 500mm and can be divided by 5.</p> <p>Other bore diameter are indicated with the actual bore diameter value (mm) or additive letter. When the bore diameter value (mm) is integer or with one place decimal, it can be indicated with this dimension directly, but be separated from the dimension series code with "/";</p> <p>When the actual bore diameter value (mm) is with two or more places decimals, the dimension is indicated with the integral part and expressed with X4.</p> <p>For example, NCF6/27X4V, it indicates the cylindrical roller bearing, indefinite series, with the bore diameter of 27.762 and full filling with rollers.</p>

Example 1:

66/6.4 Deep groove ball bearing, indefinite series, bore diameter is 6.4mm.

Example 2:

61936X1M Deep groove ball bearing, non-standard outside diameter, close to diameter series 9.

Example 3:

62/14.5 Deep groove ball bearing, dimension series 02, bore diameter is 14.5mm.

Example 4:

52706 Double-direction thrust ball bearing, indefinite series, bore diameter is 30mm.

When the code of several non-standard bearings are the same, which belong to the same type but with the slightly different dimensions, they are distinguished by adding "-" mark and add sequence number 1, 2, 3..... after each code name.

For example, 61956X1M
61956X1M-1
61956X1M-2

The prefix and suffix code for non-standard bearing according to the rules of present standard and this system.

Illustration of Cage Structure and Material Code:

SN	Bearing Type	Illustration of cage structure and material code
1	Deep Groove Ball Bearing	1) While bearing outer diameter $D \leq 400$ mm, select steel plates (strips) or brass sheet (strips) pressed cage, the suffix code of the cage not marked.

Illustration of Cage Structure and Material Code:

SN	Bearing Type	Illustration of cage structure and material code
1	Deep Groove Ball Bearing	<p>2) While bearing outer diameter $D > 400$mm, select brass solid cage, the suffix code of the cage not marked; while select outer ring guided and brass cage, cage suffix code marked as MA.</p> <p>3) While the cage suffix code not mark the guiding method, it means inner ring guided.</p>
2	Self-aligning ball bearing	<p>1) While bearing outer diameter $D \leq 200$mm, select steel plates (strips) pressed cage, the suffix code of the cage not marked.</p> <p>2) While bearing outer diameter $D > 200$mm, select brass solid cage, the suffix code of the cage not marked.</p>
3	Cylindrical roller bearing	<p>1) While select composite cage, the suffix code of the cage not marked.</p> <p>2) While select pressed cage, the suffix code of the cage marked as J. If the different structure of pressed cage, successively expressed by J, J1, J2, J3.....</p> <p>3) While select groove type cage, the suffix code of the cage marked as CJ.</p> <p>4) While select brass solid cage, the suffix code of the cage marked as M.</p> <p>5) While the bearing outer diameter $D > 400$mm, select steel solid cage, the suffix code of the cage not marked, but if the guiding method is inner or outer ring guided, shall mark the corresponding suffix code of the cage material and guiding method (outer ring guided expressed by A, inner ring guided expressed by B)</p>
4	Double-row cylindrical roller bearing	Not marked while select brass solid cage.
5	Spherical roller bearing	<p>1) While select brass solid cage, the suffix code of the cage not marked.</p> <p>2) While select pressed cage, the code expressed by "C", "CC".</p> <p>3) While select other solid cage, shall mark the suffix code accordingly.</p> <p>4) If guided by outer ring, shall mark the corresponding suffix code of the cage material and guiding method "A"</p>
6	Angular contact ball bearing	<p>1) Angular contact ball bearing with split inner bearing or two-piece outer ring (three point or four point contact), while selecting solid brass cage, the suffix code of cage not marked.</p> <p>2) Angular contact ball bearing and its variants While bearing outer diameter $D \leq 250$mm, contact angle $\alpha = 15^\circ$,</p>

Rolling Bearings

Illustration of Cage Structure and Material Code:

SN	Bearing Type	Illustration of cage structure and material code
6	Angular contact ball bearing	25° select phenolic cloth laminated tube solid cage; $\alpha = 40^\circ$ select steel sheet pressed cage; the suffix code of the cage all not marked. While bearing outer diameter $D > 250\text{mm}$, select brass or duralumin solid cage; the P5, P4, P2 level bearing product select phenolic cloth laminated tube solid cage; The angular contact ball bearing with counter bore on inner ring and its variants select phenolic cloth laminated tube solid cage; suffix code of cage not marked. 3) Double row angular contact ball bearing, select steel plate (sheet) pressed cage, the suffix code of cage not marked.
7	Tapered roller bearing	1) While bearing outer diameter $D \leq 650\text{mm}$, select steel plate pressed cage, the suffix code of cage not marked. 2) While bearing outer diameter $D > 650\text{mm}$, select steel solid pin-type cage, the suffix code of cage not marked.
8	Thrust ball bearing	1) While bearing outer diameter $D \leq 250\text{mm}$, select steel plate (sheet) pressed cage, the suffix code of cage not marked. 2) While bearing outer diameter $D > 250\text{mm}$, select solid brass cage, the suffix code of cage not marked. Other suffix code marked accordingly.
9	Thrust angular contact ball bearing	Single & double direction thrust angular contact ball bearing While bearing outer diameter $D \leq 650\text{mm}$, select brass solid cage, the suffix code of cage not marked. While bearing outer diameter $D > 650\text{mm}$, select steel solid cage, the suffix code of cage not marked.
10	Thrust cylindrical roller bearing	While bearing outer diameter $D \leq 500\text{mm}$, select brass solid cage, the suffix code of cage not marked. While bearing outer diameter $D > 500\text{mm}$, select steel solid cage, the suffix code of cage not marked. Other suffix code marked accordingly.
11	Thrust spherical roller bearing	Select brass solid cage, the suffix code of cage not marked, other suffix code marked accordingly.
12	Thrust tapered roller bearing	Select brass solid cage, the suffix code of cage not marked, other suffix code marked accordingly.

The illustration to the Change of Dimensions and Structures

The suffix YA plus number indicates various kinds of technical changes. Please refer to the suffix illustration for details.

If one type of bearing has two changes on its structure, the bearing is indicated with YA plus two digitals. For example, /YA12, it indicates the surface of outer ring and inner bore of inner ring vary from the standard design. The specific change can be referenced to the product catalogue or the supplemented technical requirements.

If one type of bearing has two or more changes on its structure at the same time, the bearing is indicated with YAD.

Note:

If the bearing suffix has Y and another letter or the appended number, it is suggested to reference the product catalogue or the supplemented technical requirements, in order to know the specific change.

The illustration to the Change of Technical Requirements

The suffix YB appended with digitals indicates all variations of the technical requirements. More details please refer to the specification of bearing suffix.

If one type of bearing has two changes on the technical requirements in the same time, the bearing is indicated by YB appended with two digitals. For example, /YB12, see specific change to the product catalogue or supplemented technical requirements.

If one type of bearing has more than two changes on the technical requirements in the same time, indicated by /YBD.

If one type of bearing has changes both on the structure and the technical requirements in the same time, the bearing is indicated with /YAB.

Prefix of Bearing and Bearing Components

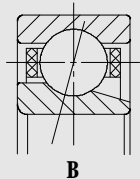
Code	Meaning	Example
B	Angular contact ball bearing with counter bore on inner ring	
F	If "F" added before the bearing series code of the inch tapered roller bearing, it indicates the cage of bearing.	Example: 25580/25520 Bearing Code of the Cage: F25500

Prefix of Bearing and Bearing Components

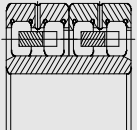
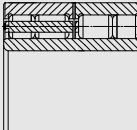
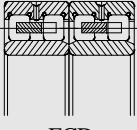
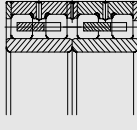
Code	Meaning	Example
FC	Four-row cylindrical roller bearing with double outer ring and single inner ring without rib.	 FC
FC···ZW	Four-row cylindrical roller bearing with single inner ring, double outer rings with double ribs on each outer ring, double-row roller come together.	 FC···ZW
FCD	Four-row cylindrical roller bearing with double outer rings and double inner rings without rib.	 FCD
FCDP	Four-row cylindrical roller bearing, double outer rings, outer ring only have central rib but with loose rib, double inner rings, without rib.	 FCDP
G-	<p>Represent bearing inner space or outer spacer in the inch series tapered roller bearing.</p> <p>The express method of inner spacer: add "G-" before the code of inch series inner ring assembly.</p> <p>The express method of outer spacer: add "G-" before the code of outer ring.</p>	<p>Example: M224749D/M224710-M224710D Bearing inner spacer expressed as: G-M224749D</p> <p>Bearing outer spacer expressed as: G-M224710</p>

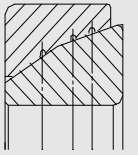
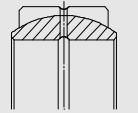
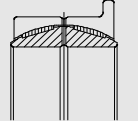
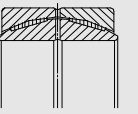
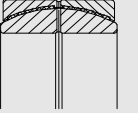
Code	Meaning	Example
GAC	Thrust plain bearing	 GAC
GE···ES	Plain radial bearing	 GE···ES
GET···CXs	Self lubricated self-aligning plain radial bearing, special series, and inner ring merged with bronze alloy, double gapped axially.	 GET···CXs
GET···CHS	Self-aligning plain radial bearing, special series, and inner ring merged with bronze alloy, double half outer ring.	 GET···CHS
GET···FHS	Self-aligning plain radial bearing, special series, outer ring merged with special self-lubricated material, double half outer ring.	 GET···FHS

Prefix of Bearing and Bearing Components

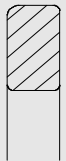
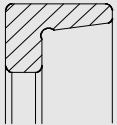
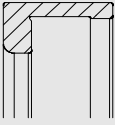
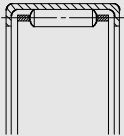
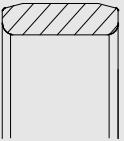
Code	Meaning	Example
GS	Cylindrical roller thrust bearing housing washer.	 GS
HJ	Separate thrust collar	 HJ
HJR	Right angle retaining ring	
HJR1	Right angle retaining ring, dimension is different with HJR	HJR, HJR1, HJR2
HJR2	Right angle retaining ring, dimension is different with HJR & HJR1	
HK	Open type pressed outer ring needle roller bearing	 HK
IR-	Inner ring of radial bearing	 IR-

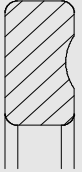
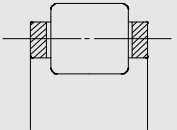
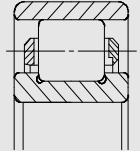
Code	Meaning	Example
IW-	Shaft washer of thrust bearing	 IW-
K	1. Assembly of rolling element and cage 2. The rings and rolling elements or only the rings of inch tapered roller bearing are made from the high carbon chromium bearing steel.	 K K3979/K3920
K1	For the inch series tapered roller bearing, the rings and rolling elements or only the ring are made by 100CrMo7.	
K2	For the inch series tapered roller bearing, the rings and rolling elements or only the ring are made by ZGCr15.	
KIW-	Thrust bearing without housing washer.	
KOW-	Thrust bearing without shaft washer.	
L	Separable inner ring or outer ring of the separable bearing	LFC4056188
LR	The inner ring assembly or outer ring assembly of separable bearing	
N	Cylindrical roller bearing, inner ring with double ribs, outer ring without rib.	 N

Prefix of Bearing and Bearing Components

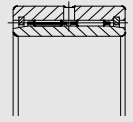
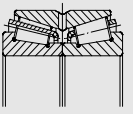
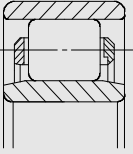
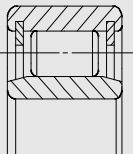
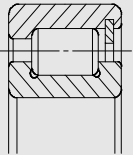
Code	Meaning	Example
NA	1. Needle roller bearing	 NA
	2. Timken double-row cylindrical roller bearing with wide cone, no central spacer.	 NA551002/NA551701D
NB	Cylindrical roller bearing without rib.	 NB
NBCL	Cylindrical roller bearing, outer ring without rib but with double snap rings, inner ring without rib.	 NBCL
NCF	NF+ snap ring	 NCF...V

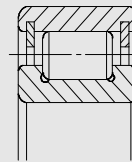
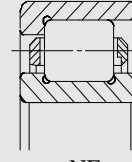
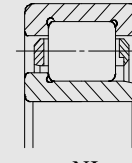
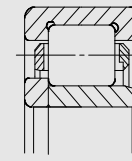
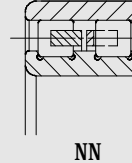
Code	Meaning	Example
NCL	Cylindrical roller bearing, outer ring without rib but with double snap rings, inner ring with double ribs.	 NCL...V
NF	Cylindrical roller bearing, inner ring with double ribs, outer ring with single rib.	 NF
NJ	Cylindrical roller bearing, outer ring with double ribs, inner ring with single rib.	 NJ
NJP	Cylindrical roller bearing, outer ring with double ribs, inner ring without rib but with loose rib.	 NJP
NN	Double-row cylindrical roller bearing, inner ring with three ribs, outer ring without rib.	 NN

Prefix of Bearing and Bearing Components

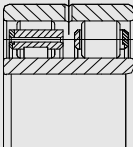
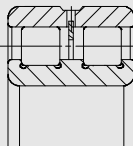
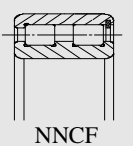
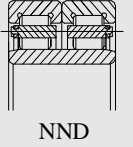
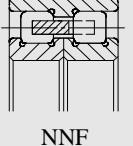
Code	Meaning	Example
NNB	Double-row cylindrical roller bearing, double inner ring and outer ring without rib.	 NNB
NNCL	Double-row cylindrical roller bearing, inner ring with three ribs, outer ring without rib but with central spacer.	 NNCL
NNCF	Double-row cylindrical roller bearing, inner ring with three ribs, outer ring with single rib and with snap ring on the other side.	 NNCF
NND	Double-row cylindrical roller bearing, single inner ring, double outer rings with double ribs.	 NND
NNF	Double-row cylindrical roller bearing, double inner rings, single outer ring with central rib and no rib on both sides.	 NNF

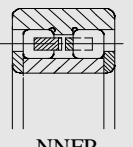
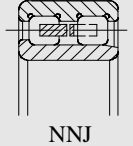
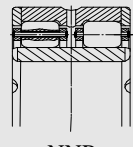
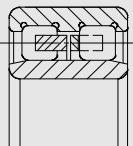
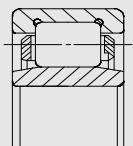
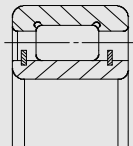
Code	Meaning	Example
NNFP	Double-row cylindrical roller bearing, single inner ring, with loose ring on two sides, single outer ring with central rib and no rib on both sides.	 NNFP
NNJ	Double-row cylindrical roller bearing, outer ring with three ribs, inner ring with single rib.	 NNJ
NNP	Double-row cylindrical roller bearing, inner ring with no rib, outer ring with central rib and with loose rib on both faces.	 NNP
NNU	Double-row cylindrical roller bearing, outer ring with three ribs, inner ring with no rib.	 NNU
NU	Cylindrical roller bearing, outer ring with double ribs, inner ring without rib.	 NU
NUCL	Cylindrical roller bearing, inner ring with no rib but with double snap rings	 NUCL

Prefix of Bearing and Bearing Components

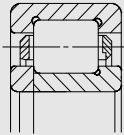
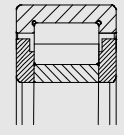
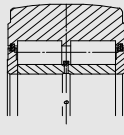
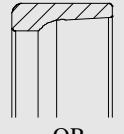
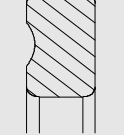
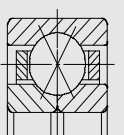
Code	Meaning	Example
NUP	Cylindrical roller bearing, outer ring with double ribs, inner ring with single rib and loose rib.	 NUP
NUTR	Cylindrical roller bearing, full components, with loose rib.	 NUTR...XS
NNTR	Double-row cylindrical roller bearing, full components	 NNTR
OR	Outer ring of radial bearing	 OR
OW	Housing washer of thrust bearing	 OW
QJ	Four-point contact bearing, two piece inner rings.	 QJ

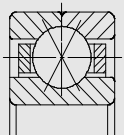
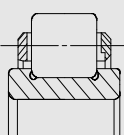
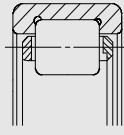
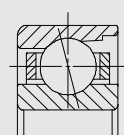
Code	Meaning	Example
QJF	Four-point contact bearing, two piece outer rings.	 QJF
R	1. Bearing with inseparable inner ring or outer ring. 2. If "R" is added before bearing series code in the inch tapered roller bearing, it indicates the tapered roller.	Example: The designation of 392/393 roller is R395
RN	N type cylindrical roller bearing without outer ring.	 RN
RNU	NU type cylindrical roller bearing without inner ring.	 RNU
S	Separable angular contact ball bearing.	

Prefix of Bearing and Bearing Components

Code	Meaning	Example
T	<p>1. Tapered roller bearing, the boundary dimension complying with GB273.1 appendix A. For example, T 2ED 020 T- Tapered roller bearing</p> <p>2- Angle series code (reference to GB273.1 appendix B) ED- Series code (reference to GB273.1 appendix B) 020- Inner ring 20mm</p> <p>2. Timken tapered roller thrust bearing</p>	<p>T</p>
TTSX	<p>Full component tapered roller bearings with convex spherical shaft washer used on screw down mechanism of rolling mill.</p>	<p>TTSX</p>
U	<p>Aligning seat washer</p>	<p>U</p>
UC	<p>Spherical out surface ball bearing with set screw.</p>	<p>UC</p>
WS	<p>Shaft washer of cylindrical roller thrust bearing.</p>	<p>WS</p>

Suffix of Bearing and Bearing Components

Code	Meaning	Example
-1,-2... A	<p>It indicates the non-standard series X1,X2, YA2,...</p> <p>1. Angular contact ball bearing, nominal contact angle $\alpha=30^\circ$</p> <p>2. Tapered roller bearing, contact angle α and the outside diameter D1 not conform to the national standard, same as there are two or more $\alpha, D1$ which is different from the national standard in one code, it will be indicated with A1, A2... by sequence. 3. Outer ring guided</p>	<p>A</p> <p>Example: 32930X2A</p> <p>Example: 61936MA</p>
AC	<p>Angular contact ball bearing, nominal contact angle $\alpha=25^\circ$</p>	<p>AC</p>
ACA	<p>Aligning roller bearing with movable central rib and asymmetrical rollers.</p>	<p>ACA</p>
/AS	<p>The needle roller bearing outer ring with lubrication hole, the additional number indicates to the number of oil holes.</p>	
/ARS	<p>The needle roller bearing outer ring with oil groove and oil hole, the additional number indicates to the number of oil holes</p>	

Suffix of Bearing and Bearing Components

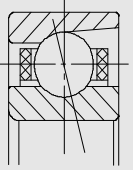
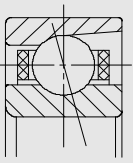
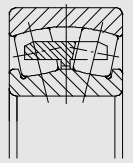
Code	Meaning	Example
A6	Inch tapered roller bearing, assembly of chamfer differed from TIMKEN, if the assembly of chamfer in one code have two or more bearings different from TIMKEN, it will be indicated with A61, A62...	Example: KLM48548A6/ KLM48510A6
B	1. Angular contact ball bearing, nominal contact angle $\alpha=40^\circ$. 2. Tapered roller bearing, contact angle enlarged (enlarge with one larger angle series) 3. Inner ring guided.	 B Example: 61836MB
C	1. Angular contact ball bearing, nominal contact angle $\alpha=15^\circ$. 2. Spherical roller bearing, inner ring with no rib but movable central rib, with symmetrical rollers, pressed steel cage. 3. Matched pair tapered roller bearing, when the axial clearance not complying with ZWZ standard, the mean value of the axial clearance should be directly added after C.	 C Example: 32032T112/DBC345 mean axial clearance is 0.345
CA	Spherical roller bearing, inner ring with no rib in the middle, small ribs on outside of inner ring, filling with symmetrical rollers, solid brass cage.	 CA

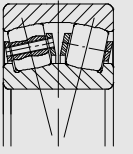
Code	Meaning	Example
CAB	CA type spherical roller bearing, pierced rollers, with pin type cage.	 CAB
CABC	CAB type spherical roller bearing, roller guiding methods improved (roller surface roughness, raceway surface roughness, change of heat treatment method), in order to reduce friction.	
CAC	CA type spherical roller bearing, roller guiding methods improved (roller surface roughness, raceway surface roughness, change of heat treatment method), in order to reduce friction.	
CAZ	CA type spherical roller bearing with symmetrical roller, with middle rib, solid cage.	
CB	Continuous casting machine bearing.	
CC	C type spherical roller bearing, roller guiding method improved (roller surface roughness, raceway surface roughness, change of heat treatment method), in order to reduce friction.	
CD	The dowel hole on the oil groove.	
/CM	Clearance of the deep groove ball bearing for electrical motor.	
/CN	0 group clearances. /CN combined with the letter H, M or L, it indicates the clearance scope decreased in half; or combined with P, it indicates the clearance scope deviated.	

Suffix of Bearing and Bearing Components

Code	Meaning	Example
/CN	Example: /CNH 0 group clearance decreased in half, belonging to the upper part. /CNM 0 group clearance decreased in half, belonging to the middle part. /CNL 0 group clearance decreased in half, belonging to the lower part. /CNP clearance scope lies in the upper part of 0 group clearance and the lower part of C3 grade.	
/C1	Clearance conforms to the standard group 1.	
/C2	Clearance conforms to the standard group 2.	
/C3	Clearance conforms to the standard group 3.	
/C4	Clearance conforms to the standard group 4.	
/C5	Clearance conforms to the standard group 5. Letter H, M, L or P can follow directly after the clearance code, it indicates the clearance scope decreased in half or deviated, see explanation of /CN, but P must be added after the lower clearance grade. For example, /C3P clearance scope lies in the upper part of group C3 and the lower part of grade C4.	
/C9	Bearing clearance not conforms to the present standard. When two or more clearances in one code are different from the present standard, it will be indicated with the added digitals, such as C91, C92...	Example: NN3020K/C9 NN3020K/C9 l indicates the two clearance it is different with current standard.
/C9T	The clearance of double-row cylindrical roller bearing's raceway are different.	

Code	Meaning	Example
/CR	When the matched pair tapered roller bearings have the radial clearance requirements, the mean value of clearance will be added after CR.	Example: 32048X2AT171/DBC275 Tapered roller bearing back-to back arrangement, mean radial clearance is 0.275.
/CRA9	The radial bearing clearance none standard, requirements to axial clearance.	
D	1.Double row angular contact ball bearing, double inner ring, contact angle *=45? 2.Double row tapered roller bearing, no inner spacer or outer spacer, un-grinded end face. 3.Inch tapered roller bearing, inner ring with double raceway or outer ring with double raceway. 4.Split bearing.	 D D D D
/DB	Two single deep groove ball bearings or angular contact ball bearings or tapered roller bearings used for the back to back paired mounting.	 DB DB
/DBY	Two single-row tapered roller bearing, for back to back mounting, with inner spacer, without outer spacer.	 DBY
/DC	Double row angular contact ball bearing with double outer ring.	 DC

Suffix of Bearing and Bearing Components

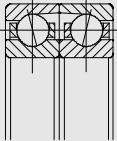
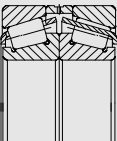
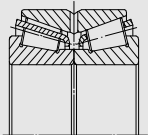
Code	Meaning	Example
/DF	Two single deep groove ball bearings or angular contact ball bearings or tapered roller bearings used for the face to face paired mounting.	 <p>DF</p>  <p>DF</p>
/DH	Single direction thrust bearing with two housing washers.	
/DS	Single direction thrust bearing with two shaft washers.	
/DT	Two single deep groove ball bearings or angular contact ball bearings or tapered roller bearings used for the same direction tandem paired mounting.	
D1	Double row tapered roller bearing, with no inner spacer, grinded end face.	 <p>D1</p>
E	Inside design is changed, enhanced structure.	
F	The materials of steel, nodular cast iron or power metallurgical solid cage are indicated by the added digitals. F1- Carbon steel F2- Graphite steel F3- Nodular cast iron	<p>Example: 239/1180CAKF1/W33, Cage is made by 45 Steel</p>

Code	Meaning	Example
F	F4- Powder metallurgy FA- Steel, nodular cast iron or power metallurgical solid cage, outer ring guided. FB- steel, nodular cast iron or power metallurgical solid cage, inner ring guided. FE- steel solid cage-phosphorized.	
-FS	Felt-ring sealed.	
/FT	Five set tandem arranged bearing.	
G1	Gear quenched.	
/GP	Dimension tolerance equals to level 0, rotating precision equals to level 5.	
/HA	Ring rolling elements and cage or only the ring and rolling elements are made from vacuum smelted bearing steel.	Example: 7309BM/HADBYA3
/HC	Ring and rolling elements or only ring or rolling elements are made from case hardened steel(/HC-20Cr2Ni4A;/HC1-20Cr2Mn2MoA;/HC2-15Mn).	Example: 3519/500/HC
/HCE	If the metric series bearing, indicates rings and rolling elements are choose high quality carburized steel.	
/HCER	For the metric series bearing, only the roller is are made by high quality carburized steel.	
/HCG2I	Indicates the outer ring & rolling elements are made by carburized steel, inner ring made by GCr18Mo.	
/HCI	Indicates the inner ring made by carburized steel.	

Suffix of Bearing and Bearing Components

Code	Meaning	Example
/HCO	Indicates the outer ring made by carburized steel.	
/HCOI	Indicates only the outer ring & inner ring made by carburized steel.	
/HCOR	Indicates only the outer ring & rolling element are made by carburized steel.	
/HCR	To distinguish the bearing with same designations, only the rolling elements are made by carburized steel.	
/HE	Ring, rolling elements and cage or only the ring and rolling elements are made by electroslag remelting bearing steel (military first grade steel) ZGCr15.	
/HG	Ring, rolling elements and cage or only the ring and rolling elements are made by electroslag remelting bearing steel (military first grade steel) ZGCr15.	
/HG2CR	Indicates the bearing ring is made by GCr18Mo, rolling elements is made by carburized steel.	
/HG2I	If belongs to radial bearing, indicates the inner ring is made by GCr18Mo, outer ring & rolling elements is made by GCr15. If belongs to thrust ball bearing, indicates that the shaft washer is made by GCr18Mo, housing washer & rolling elements are made by GCr15.	
/HG2O	Indicates the bearing outer ring made by GCr18Mo.	
/HN	Ring and rolling elements are made by heat resistant steel (/HN-GCr4Mo4V; /HN1-Cr14Mo4;/HN2-Cr15Mo4V; /HN3-W18Cr4V).	

Code	Meaning	Example
/HP	Ring and rolling elements are made from beryllium bronze or other anti-magnetic materials. When material is changed, it is indicated by the added digitals.	
/HQ	Ring and rolling elements are made from the unusual materials (/HQ- plastic; /HQ1-ceramic alloy)	
/HU	Ring, rolling elements and cage or only the ring and rolling elements are made from the unhardened stainless steel 1Cr18Ni9Ti.	
/HV	Ring, rolling elements and cage or only the ring and rolling elements are made from the unhardened stainless steel (/HV-9Cr18; /HV1-9Cr18Mo).	
J	Pressed steel cage. When material is changed, it is indicated with the added digitals.	
JA	Pressed steel cage, outer ring guided.	
JE	Pressed unhardened steel cage after phosphating.	
JR	Cage is riveted with two unhardened steel sheets(for large size thrust ball bearing).	
JW	Cage is welded with unhardened steel sheet.	
K	Tapered bore bearing. Conicity is 1: 12.	Example: 24040CAK30/W33
K30	Tapered bore bearing. Conicity is 1: 30.	
L	Light alloy solid cage. When the material of cage is changed, it is indicated with the appended digitals.	
L3	Zinky aluminum alloy ZznA127Cu2 or material is ZA30-C-Q/WZ.J41362.	
LA	Light alloy solid cage, outer ring guided.	
LB	Light alloy solid cage, inner ring guided.	

Suffix of Bearing and Bearing Components

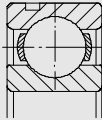
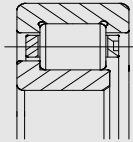
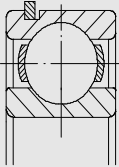
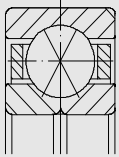
Code	Meaning	Example
/LM	Cage is made by magnesium alloy.	
-LS	Dust proof ring.	
M	Brass solid cage.	Example: NU315M
MA	Brass solid cage, outer ring guided.	Example: 6034MA
MB	Brass solid cage, inner ring guided.	
N	Bearing with snap groove on outer ring.	 N
NB	Bearing with narrow inner ring.	
NB1	Bearing with narrow inner ring, one side is narrow.	 NB1
NR	Bearing with snap groove and snap ring on outer ring.	 NR
N1	Bearing with a positional notch on outer ring.	
N2	Bearing with two or more symmetrical positional notch on outer ring.	 N1*2

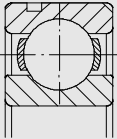
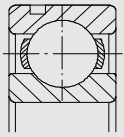
Code	Meaning	Example
N4	N+N2 Positional notch and snap groove are not on the same side.	 N4
N6	N+N2 Positional notch and snap groove are on the same side.	 N4
/P0	Tolerance grade conforms to the standard P0, code is omitted.	
/P6	Tolerance grade conforms to the standard P6.	
/P6X	Tolerance grade conforms to the standard P6X.	
/P5	Tolerance grade conforms to the standard P5.	
/P5C2H	Tolerance level comply with 5 level in standard, clearance is the upper limit in group 2.	
/P4	Tolerance grade conforms to the standard P4.	
/P2	Tolerance grade conforms to the standard P2.	
Q	Bronze solid cage, indicated with the appended digitals, which means different materials. Q1- Aluminum iron manganese bronze. Q2- Silicon iron zinc bronze. Q3- Silicon nickel bronze. Q4- Aluminum bronze. Q5- Stannum bronze (ZQSn10-1).	

Suffix of Bearing and Bearing Components

Code	Meaning	Example
/QB	Four sets of bearings in pair tandem matched and back to back mounting.	 /QB
/QF	Four sets of bearings in pair tandem matched and face to face mounting.	 /QF
/QT	Four sets of bearings in tandem mounting.	 /QT
/QBT	Four sets of bearings, three in tandem and one in back to back mounting.	 /QBT
/QFT	Four sets of bearings, three in tandem and one in face to face mounting.	 /QFT
/QR	Four deep groove ball bearings or cylindrical roller bearings combined, radial lode distributed equally.	 /QR
R	Bearing with snap rib on outer ring (convex outer ring).	
R1	Track roller snap ring groove dimension comply with DZN471 standard.	

Code	Meaning	Example
R2	Track roller snap ring groove dimension comply with WRE standard.	
R3	Track roller snap ring groove dimension comply with JIS standard.	
R4	Track roller snap ring groove dimension comply is not standard.	
-RS	Bearing with frame system rubber seal ring (contact system)	
-RS1	Bearing with frame system rubber seal ring (contact system), the material of seal ring is sulfureted rubber.	
-RS2	Bearing with frame system rubber seal ring (contact system), the material of seal ring is fluoride rubber.	
-2RS	Bearing with RS sealed on both sides.	
-2RS1	Bearing with RS1 sealed on both sides.	
-2RS2	Bearing with RS2 sealed on both sides.	
-RSN	RS+N Sealed on the opposite side of snap groove.	
-RS1N	RS1+N	
-RS2N	RS2+N	
-RSNR	RS+NR Sealed on the opposite side of snap ring.	
-RS1NR	RS1+NR	
-RS2NR	RS2+NR	

Suffix of Bearing and Bearing Components

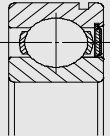
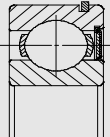
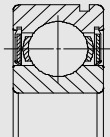
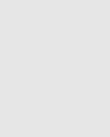
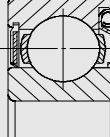
Code	Meaning	Example
-RSNB	RS+NR Sealed on the opposite side of snap ring.	 RSNB, RS1NB, RS2NB
-RS1NB	RS1+N	
-RS2NB	RS2+N	
-RSNBR	RS+NR Sealed on the same side of snap ring.	 RSNBR, RS1NBR, RS2NBR
-RS1NBR	RS1+NR	
-RS2NBR	RS2+NR	
-2RSN	2RS+N	 2RSN, 2RS1N, 2RS2N
-2RS1N	2RS1+N	
-2RS2N	2RS2+N	
-2RSNR	2RS+NR	 2RSNR, 2RS1NR, 2RS2NR
-2RS1NR	2RS1+NR	
-2RS2NR	2RS2+NR	
-RSZ	RS+Z Bearing with frame type rubber sealing ring (contact system) on one side and with shield on the other side.	 RSZ, RS1Z, RS2Z
-RS1Z	RS+Z	
-RS2Z	RS2+Z	

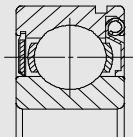
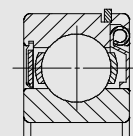
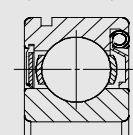
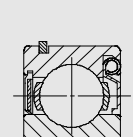
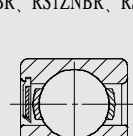
Code	Meaning	Example
-RSZN	RS+Z+N Sealed on the other side of snap groove.	 RSZN, RS1ZN, RS2ZN
-RS1ZN	RS1+Z+N	
-RS2ZN	RS2+Z+N	
-RSZNR	RS+Z+NR Sealed on the other side of snap ring.	 RSZNR, RS1ZNR, RS2ZNR
-RS1ZNR	RS1+Z+NR	
-RS2ZNR	RS2+Z+NR	
-RSZNB	RS+Z+N Sealed on the same side of snap groove.	 RSZNB, RS1ZNB, RS2ZNB
-RS1ZNB	RS1+Z+N	
-RS2ZNB	RS2+Z+N	
-RSZNBR	RS+Z+NR Sealed on the same side of snap ring.	 RSZNBR, RS1ZNBR, RS2ZNBR
-RS1ZNBR	RS1+Z+NR	
-RS2ZNBR	RS2+Z+NR	
-RZ	Bearing with frame type rubber sealing ring (non-contact type).	 -RZ

Suffix of Bearing and Bearing Components

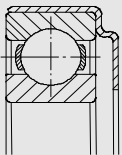
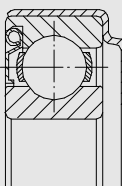
Code	Meaning	Example
-2RZ	Bearing with RZ sealed on both sides.	
S	Martensite quenching.	
/SP	Ultra precision grade, dimension tolerance equals to P5, rotating precision equals to P4.	
/S0	Bearing ring tempered in high temperature, which can reach to 150°C .	
/S1	Bearing ring tempered in high temperature, which can reach to 200°C .	
/S2	Bearing ring tempered in high temperature, which can reach to 250°C .	
/S3	Bearing ring tempered in high temperature, which can reach to 300°C .	
/S4	Bearing ring tempered in high temperature, which can reach to 350°C .	
SC	Radial bearing with outer cover.	
SC-Z	Radial bearing with outer cover and shield.	
T	1. When the assemble height dimension of the matched pair tapered roller bearing not conform to the standard specification, the assemble height dimension will be added directly after T. 2. Phenolic cloth laminated tube solid cage	Example: 32032T112/DBC345 Tapered roller bearing back-to-back arrangement, stand high is 112

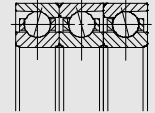
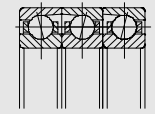
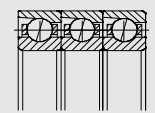
Code	Meaning	Example
/T	If the starting torque of bearing has special requirements, digitals added after indicates the starting torque.	
/RT	If the rotating torque of bearing has special requirements, digitals added after indicates the rotating torque.	
TA	Phenolic cloth laminated tube, outer ring guided.	
TB	Phenolic cloth laminated tube, inner ring guided.	
/TBT	Three sets of bearings in tandem and face to face arrangement.	
TH	Engineering plastic cage.	
/TFT	Glass fibre-reinforced phenolic resin cage (tube shape)	
TN	TN1- Nylon TN2- Polyamide (PA) TN3- Polyimide TN4- Polycarbonate TN5- Paraformaldehyde	
/TT	Three sets of bearings in tandem arrangement.	

Suffix of Bearing and Bearing Components

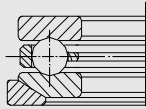
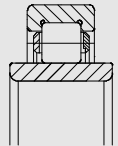
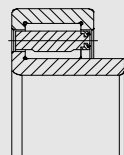
Code	Meaning	Example
U	Thrust ball bearing with spherical seat washer.	 U
/UP	Super precision grade, dimension tolerance equals to P4, rotating precision is higher than P4.	
V	Full complement rolling elements (no cage).	
/V	Vibrating speed group of bearing. The appended digital indicates different groups. V1- vibrating speed group conforms to the standard V1 group. V2- vibrating speed group conforms to the standard V2 group. V3- vibrating speed group conforms to the standard V3 group.	
VB	Vibration Screen Bearing.	
WB	Bearing with wide inner ring (Both sides wide).	 WB
WB1	Bearing with wide inner ring (Single side wide).	 WB1

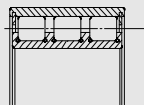
Code	Meaning	Example
WC	Bearing with wide outer ring.	 WC
/W124	Indicates precision electronic motor bearing (execute standard Q/WZ.14124).	
/W20	Bearing with three lubricating oil holes on outer ring (no oil groove).	
/W20A	Bearing with four lubricating oil holes on outer ring (no oil groove)	
/W20C	Bearing with six lubricating oil holes on outer ring (no oil groove)	
/W20D	Bearing with eight lubricating oil holes on outer ring (no oil groove)	
/W20T	Bearing with three lubricating oil holes on inner ring (no oil groove)	
/W23	Bearing with six lubricating oil holes on inner ring.	
/W26	Indicates the metallurgical bearings (execute standard Q/WZ.J14281)	
/W281	Bearing with oil groove and three lubricating oil holes on outer ring.	
/W33	Bearing with oil groove and four lubricating oil holes on outer ring.	
/W33A	Bearing with twelve lubricating holes on outer ring.	
/W33D	Bearing with eight lubricating holes on inner ring.	
/W33T	Bearing with six lubricating holes on inner ring.	
/WN26	Bearing with oil groove and six lubricating oil holes on outer ring.	

Suffix of Bearing and Bearing Components

Code	Meaning	Example
/W33X	Bearing with oil groove and six lubricating oil holes on outer ring.	
/W33XB	Bearing outer ring with six lubricating oil hole, and the diameter of the oil hole is $\phi 15$.	
/W512	/W512 W23+W33	
/W513	/W513 W26+W33	
/W518	/W518 W20+W26	
/W519	/W519 W33X+WN26	
/W520	/W520 W33+WN26	
/WN33	/WN33 Bearing with oil groove and three lubricating oil holes on inner ring.	
X	Full complement cylindrical roller bearing with loose rib.	

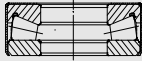
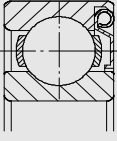

Code	Meaning	Example
X1	Non-standard outer diameter.	
X2	Non-standard width(height).	
X3	Non-standard outer diameter, width (height) (standard bore diameter).	Example:NCF6/27X4V
X4	Inner diameter select the integer of non-standard bearing, while inner diameter is not integer and have two and more decimal places, indicated by X4 as select integer of the figures.	Cylindrical roller bearing, Inner diameter is 27.762, Full complement rolling element.
-XRS	Four row tapered roller bearing, with multi sealed parts. (more than two sealings)	<p>-XRS 380680-XRS/HC</p>
/Y	Y Combines with another letter (such as YA, YB) or more digitals to identify the change of the non-series which can not be indicated with the present suffix code. YA- Structure change. YA1- Outside surface of outer ring has changed comparing to standard design. YA2- Bore of inner ring has changed comparing to the standard design. YA3- End face of bearing ring has changed comparing to the standard design. YA4- Raceway of bearing ring has changed comparing to the standard design. YA5- Bearing rolling elements has changed comparing to the standard design. YA6- Bearing mounting chamfer has changed comparing to the standard design. YA7- Bearing rib or flange has changed comparing to the standard design.	

Suffix of Bearing and Bearing Components

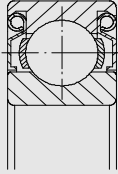
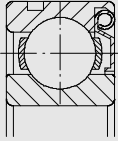
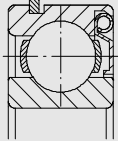
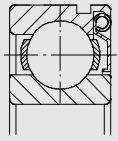
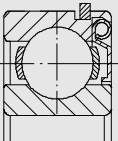
Code	Meaning	Example
/Y	<p>YA8- Bearing cage structure changed.</p> <p>YA9- Bearing contact angle has changed comparing to the standard design.</p> <p>YA10- Double-row tapered roller bearing, inner spacer with oil groove and oil hole.</p> <p>YAB- Structure and technical specification has changed at the same time.</p> <p>YAD- One type of bearing has two or more changes on structure.</p> <p>YB- Technical specification has changed.</p> <p>YB1-Surface of bearing ring has plated coating.</p> <p>YB2- Bearing dimension and tolerance changed.</p> <p>YB3- Surface roughness of bearing ring changed.</p> <p>YB4- Heat treating specification (e.g. hardness) changed.</p> <p>YB5- Structure and position tolerance have special requirements.</p> <p>YBD- One type of bearing has two or more changes on technical specification.</p>	
ZH	Thrust bearing with shielded housing washer.	
ZL	Seal spring compression ring.	
ZS	Thrust bearing with shielded shaft washer.	
-Z	Bearing with shield on one side.	

Code	Meaning	Example
-ZZ	Bearing with shields on both sides.	
-ZN	Z+N: Shield is on the different side of snap groove.	
-ZNR	Z+NR: Shield is on the other side of snap groove and snap ring.	
-ZNB	Z+NB: Shield is on the same side of snap groove.	
-ZNBR	Z+NR: Shield is on the same side of snap groove and snap ring.	

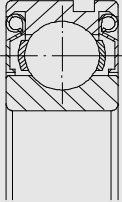
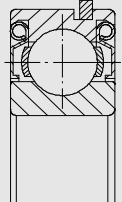
Suffix of Bearing and Bearing Components

Code	Meaning	Example
/Z	Z1- vibrating acceleration rating group conforms to the standard Z1 group. Z2- vibrating acceleration rating group conforms to the standard Z2 group. Z3- vibrating acceleration rating group conforms to the standard Z3 group.	
-2ZN	2Z+N: Bearing with shields on both sides, outer ring with snap groove.	 2ZN
-2ZNR	2Z+NR: Bearing with shields on both sides, outer ring with snap groove and snap ring.	 2ZNR
/ZP	Dimensional tolerance equals to grade 6, rotating precision equals to grade 5.	
-ZT	Thrust cylindrical roller bearing, three row roller lean against together.	 ZT

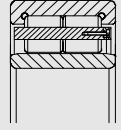
Code	Meaning	Example
ZW	Double-row needle rollers and cage assembly.	 ZW
/Z	Four-row cylindrical roller bearing, tow-row roller lean against together. The bearing vibration acceleration rated group. The appended digital indicates different groups.	

- The quantities of the bearing collocation group
 /D- two sets of bearings
 /T- three sets of bearings.
 /Q- four sets of bearings.
 /P- five sets of bearings.
 /S- six sets of bearings.
- Bearing arrangement of the bearing collocation
 B- Back to back
 F- Face to face
 T- Tandem arrangement
 G- Universal matching
 BT- Back to back & Tandem.
 FT- Face to face & Tandem
 BC- Back to back tandem arrangement in pairs.
 FC- Face to face tandem arrangement in pairs.
 Notes: 1) & 2) can combines several kinds of collocation types. Details please see the meaning of bearing suffix code and examples.

- The radial clearance in collocation, pre-load and allocation of axial- load.
 The test appended after the collocation code indicates the property:
 GA-Light pre-load. Pre-load value relative small (deep groove and angular contact ball bearing).
 GB-Medium pre-load. Pre-load value larger than GA (deep groove and angular contact ball bearing).
 GC- Heavy pre-load. Pre-load value larger than GB (Deep groove and angular contact ball bearing).
 Gxxx- pre-load is xxx special preload value (append pre-load value after the code directly, unit is N)
 For angular contact ball bearing,"G" can be omitted.
 G- Special pre-load, the number append directly express the magnitude of pre-load.
 CA- Axial clearance is relative small (deep groove and angular contact ball bearing).
 CB- Axial clearance is larger than CA (deep groove and angular contact ball bearing).

Rolling Bearings

CB- Axial clearance is larger than CB (deep groove and angular contact ball bearing).
 CG- Axial clearance is 0 (tapered roller bearing)
 R- Radial clearance equally distributed.
 Example 1: 7210C/DBGA- angular contact ball bearing 7210C, contact angle $\alpha=15^\circ$, back to back arrangement with light pre-load.
 Example 2: 6210/DFGA-deep groove ball bearing 6210, after grinded endface, face to face arrangement, with light pre-load.
 Example 3: 7210C/TFT- angular contact ball bearing 7210C, contact angle $\alpha=15^\circ$ three sets matched arrangement, two sets of tandem arrangement and one set of face

to face arrangement.
 Example 4: 7210AC/QBT- angular contact ball bearing 7210AC, contact angle $\alpha=25^\circ$, four sets matched arrangement, three sets of tandem arrangement and 1 set back to back arrangement.
 Example 5: NU210/QTR cylindrical roller bearing NU210, four sets matched arrangement, pre-load uniformly distributed.
 Example 6: 7210C/PT angular contact ball bearing 7210C, contact angle $\alpha=15^\circ$, five sets tandem arrangement.
 Example 7: 7210C/G325-angular contact ball bearing 7210C, contact angle $\alpha=15^\circ$, special pre-load value is 325N.

Case of the Combination of Bearing Basic Code and Suffix

1. 6212-2RS/HAP93YA5
 Basic code 6212 deep groove ball bearing, with inner diameter equals to 60mm.
 Suffix code 2RS, with double side sealing ring.
 HA Rings and rolling elements material is vacuum-degassed steel.
 P63 Tolerance level comply with level 6 required, internal clearance of bearing comply with group 3.
 YA5 Rolling element design is different with 6212-2RS.

2. FC3854168Q1/HG2P69YA4
 Basic code FC3854168, four-row cylindrical roller bearing, single inner ring, double outer ring, inner diameter 190mm, outer diameter 270mm, width 168mm.
 Suffix code Q1 indicates the cage material is bronze (ZCuAl10Fe3Mn2).
 HG2 Ring material select GCr18Mo.
 P69 Tolerance level comply with grade 5 required in the standard. Bearing internal clearance not comply with current standard.
 YA4 bearing raceway on the ring have different design with standard design.

3. 22316X2CAK3/HAC9W33YA8
 Spherical roller bearing with basic code 22316, inner diameter 80mm.
 Suffix code X2 indicates the bearing ring width is different with standard design.
 CA type solid cage, symmetrical roller, inner ring without center rib, 2 small ribs on each end.
 Tapered bore, conicity 1:12.
 F3 cage material choose nodular cast iron.
 HA bearing ring choose vacuum-degassed steel.

C9 bearing internal clearance not comply with current standard
 W33 bearing outer ring have lubricating oil groove and three lubricating hole.
 YA8 cage structure have different design other than standard design
 4. 3806/685.8-XRS/HCC9
 Basic code 3806/685.8, four-row tapered roller bearing, inner diameter is 685.8mm, Indefinite boundary dimension series.
 Suffix code XRS with double sealing ring on both side. Double inner ring with sealing ring, outer ring double side with 0 shape ring, multi position sealing.
 HC bearing ring and rolling element use carburized steel (G20Cr2Ni4).
 C9 bearing internal clearance not comply with current standard.

The illustration to the Sequence of Bearing Code

Bearing Code	Prefix Code	Components of Bearing	
	Basic Code		
Suffix Code	1	Internal structure changed	
	2	Sealing, dust-proof, ring changed	
	3	Cage and its material	
	4	Bearing material	
	5	Tolerance grade	
	6	Clearance	
	7	Application	
	8	Vibration features	
	9	Heat treatment features	
	10	Lubrication features	
	11	The structure and technical requirement change not in serial (YA/YB) and etc.	

While composing the ZWZ bearing designations, the suffix code is located on the right side after the basic code with distance of half of Chinese characters (except the designation including "-" or "/" when there are more changed items, follows the sequence in the form above from left to right. While the change content after group 4 (including group

4), separate by "/" before the designation with previous code. The last 2 group changed items, which after the 4 groups changes, when the shown number or test meaning can make confusion, space half Chinese characters between 2 designation.
 Example: 6215-2RS/HAP63 V2YA7

The Description for the Drawn up of Current Bearing Code

Deep Groove Ball Bearing
 While /YA7 in the suffix code, it means inner ring flange diameter have different design with standard design.
 Cylindrical Roller Bearing
 The different kinds of drawings coexists in ZWZ system.
 The boundary dimensions comply with national standard have two types, enhanced type and none enhanced type.
 Enhanced type with the letter "E", none enhanced type doesn't have letter "E".
 While cage choose composite cage, cage suffix code not marked.

Rolling Bearings

Example: N314E: composite cage, enhanced structure.

- N314EM: brass cage, enhanced structure.
- N314M: brass cage, none enhanced structure.

Spherical Roller Bearing

1. Symmetrical roller, pressed cage, basic code appended with "C" or "CC".
2. Asymmetrical roller, half cage old structure type, directly shown by basic code.
3. Symmetrical roller, solid cage, appended "CA", basic code while involves other changes, see the illustration of the bearing suffix code.
4. Symmetrical roller, solid cage, with inner spacer, append "ACA" after basic code*is transition code.

Four-point angular contact ball bearing

Because of the four-point contact angular contact ball bearing manufactured by ZWZ basically adopt brass cage, while select brass cage, cage suffix code not marked.

Tapered Roller Bearing

The different kinds of drawings coexists in ZWZ system*the boundary dimension comply with the requirements old national and new national standard in two conditions. According to the conditions of ZWZ, for the single-row tapered roller bearing which boundary dimensions not comply with new national boundary dimensions, due to the contact angle and raceway diameter also different with new national standard, so that indicated by "X2A" after bearing code.

Example 32028X2A

- X2: Indicates bearing width and bearing ring width different with new national standard.
- A: Contact angle, outer ring raceway dimension is different with new national standard.

Double & four- row tapered roller bearing, the boundary dimension not comply with new national standard, indicated by X2 directly after basic code.

For the same type non-standard bearing with minor differences in its boundary dimensions and with same bearing code, use mark "-" appended with serial number 1,2,3..... to distinguish each other.

Example:

- 352948X2
- 352948X2-1

Spherical Roller Thrust Bearing

1. Asymmetrical roller, select brass solid cage, directly shown by basic code.
2. Asymmetrical roller, select pressed cage, appended with "J" after bearing code, if two kinds of pressed cage coexists, use letter "E" to distinguish one kind of cage.

Example:

- 29424: Brass solid cage
- 29424E: pressed cage
- 29424J: pressed cage, roller diameter, roller quantities is different with 29424E.
- 3. Old structure 9069000 type, change to new code 29000/YAD

Example:

- Old code: 9069244
- New code: 29244/YAD

Accessories of Rolling Bearing

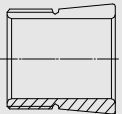
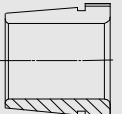
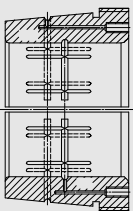
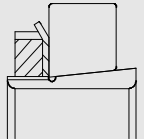
Code	Meaning	Example
A	Adapter sleeve	 A
AH	Standard designed withdrawal sleeve Appended letter or number after AH means the different structure of withdrawal sleeve: AH- withdrawal sleeve with conicity 1:12 AH2- withdrawal sleeve with conicity 1:30 AHX- withdrawal sleeve with conicity 1:12 and Thread size different with original.	 AH
AOH	Withdrawal sleeve, with oil passage and oil groove for mounting and dismounting by oil press methods, other design is same as AH type design.	 AOH
H	Adapter sleeve	 H

Accessories of Rolling Bearing

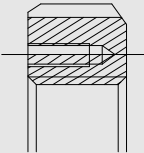
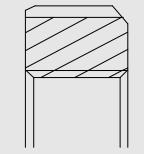
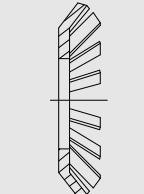
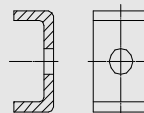
Code	Meaning	Example
HM	Locknut, indicate metric series trapezoidal thread.	 HM
KM	Lock nut, indicates metric series normal thread	 KM
MB	Locking washer straight inner jaw.	 MB
MBA	Locking washer indicate inner jaw bending inside.	
MBB	Locking washer indicate inner jaw bending outside.	
MS	Locking clip The above accessories when the design if different with standard design, expressed by "C" after the code, if there are several dimensions different with standard dimensions appended C1, C2 after code in sequence Example: AH3164C AH3164C1	 MS

Draw up Method of Special Type Bearing

Slewing bearing coding method

1. Constitute of designation and coding method
Designation contains 3 parts:
Type code, dimensional code, suffix code
The express method shown as follows.

2. Type Code

HAW- parallel roller arrangement slewing bearing outer ring with gear.
HSB- four-point contact slewing bearing without gear.
HSW- four point contact slewing bearing, gear on outer ring.
HSN-four point contact slewing bearing, gear on inner ring.
HSQB- four-point contact slewing bearing without gear.(ring structure different with HSB).
HSQW- four-point contact slewing bearing, gear on outer ring(ring structure different with HSB).
HSQN-four-point contact slewing bearing, gear on inner ring(ring structure different with HSB).
HTB- Thrust ball slewing bearing without gear.
HY1B- single shaft washer double housing washer three-row roller slewing bearing.
HYB- single housing washer, double shaft washer three-row roller slewing bearing.
HYS- slewing bearing upper level with cylindrical roller, lower level with steel ball.
HYW- single housing washer with gear double shaft washer, three-row roller slewing bearing.
HY1N- single shaft washer with gear, double housing washer three-row roller slewing bearing.

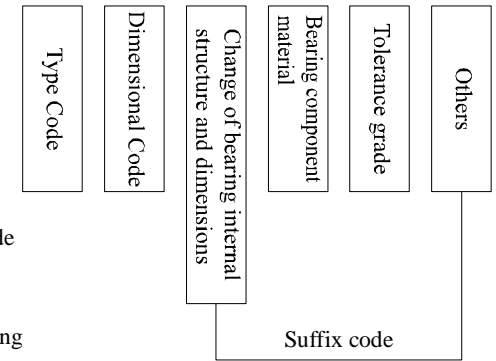

HJB- cross roller slewing bearing.
HJW- cross roller slewing bearing outer ring with gear.
HJN- cross roller slewing bearing inner ring with gear.

3. Illustration method of dimensional code
Directly indicated by rotary center diameter dimension. The rotary center diameter dimension means the rotary center of upper and lower roller.

4. Suffix code
Use this to express the variation of internal structure, dimension, component material, tolerance level, clearance and etc.
Because of this type of bearing belongs to special purpose bearing, technical requirement very complicate, most of the content directly marked on the product drawings, so only define item as follows:
a) four-point contact angular contact slewing bearing, cross roller slewing bearings, while it is double raceway, appended "D" after the rotary center diameter dimension.
Example: HSN 410D
b) While for the same type of bearing, its rotary center diameter dimension is same, but the

Rolling Bearings

boundary dimension and structure is different. Use "X" after rotary center diameter dimension, to express the variation of of its dimension and structure, for the same type, same rotary center dimeter have different kinds of changes, than use "X1" "X2".....in sequence

Example:HSN1535X

c) For the same type of bearing, only the dimension of the location hole is different, than use "K" to express.

Example:HJB2800K

To express the location hole dimension is different with the standard HJB2800 bearing in the catalogue.

d) For same type of bearing, both with full complement rolling element and also have isolate block, the isolate block structure indicated by letter "A".

Example:HSB1094, HSB1094A

e) While bearing component is made by material other than 42CrMo, than use suffix code "C" to express.

f) Bearing tolerance level according to the regulation of normal purpose bearing code.

The Selection of Bearing

There are diverse kinds, types and dimensions of rolling bearings. In order to perform the expected performance of the mechanical devices, it is critical to choose the most appropriate bearings.

In bearing selection, there are many elements needs to be considered, study, evaluate from different aspects, the relevant procedure of bearing selection are not special regulated, but the general sequence are listed as follows:

Working conditions of the mechanical device and the bearings.

- Define the requirements to bearings.

- Choose the type of the bearing.

- Choose the configuration pattern of the bearing

- Choose the dimensions of the bearing.

- Choose the specifications of the bearing

- Choose the mounting method for the bearing

The Operating Conditions and Environment Conditions of Bearing

Correct identify the position of application in the mechanical device and the use conditions & surrounding conditions are the pre-conditions of choosing the proper bearing. For this purpose, the following figures and informations are required:

The functions and structure of the mechanical device.

- The position of application.

- Loads (magnitude and directions).

- Rotate speed.

- Vibration and shock.

Bearing temperature (surrounding temperature and rises).

Surrounding ambiance (corrosion, cleanness, lubrication).

The Selection of Bearing Type

Items of Analyses		Methods of selection
Mounting space	Those the bearing type which can be installed into the mounting space	Since the rigidity and strength of the shaft have been considered in the designing, the shaft neck must be determined at first. But there are too may dimensional series and types, the most appropriate type must be chosen.
Load	Strength, direction and nature of the load [the load carrying capacity is indicated by basic load rating whose value is provided in the bearing dimension tables]	The load is rich in variations, such as the amount of the load, whether there is only radial load or not, whether the axial load is in single-direction or double direction, the amount of vibration or shock and others. These factors must be considered before choosing the most appropriate bearing type. Normally, the radial load carrying capacity is increasing as following sequences listed as follows, when bearings with the same ID : [Deep Groove Ball Bearing < Angular Contact Ball Bearings < Cylindrical Roller Bearings < Tapered Roller Bearings < Spherical Roller Bearings]

The Selection of Bearing Type

Items of Analyses		Methods of selection
Rotating speed	The bearing type which suitable for the mechanical rotations. [the limit valor of rotating speed is indicated by limiting speed (rpm) whose figures are provide in the bearing dimension tables.]	The limit speed of the bearing is not only determined by the bearings type but also limited by bearing dimensions, cage type, precision, load carrying conditions, and lubrication methods. These factors must be considered when selecting bearings. The following bearings are applied for high speed rotation: [Deep Groove Ball Bearings, Angular Contact Ball Bearings, Cylindrical Roller Bearings]
Running Accuracy	Those can satisfy the running accuracy requirements. [The dimensional accuracy and running accuracy have been standardized according to national standards (GB)in bearing types.]	Machine tool spindles, gas turbines and control machines entail high rotation precision, high speed and low friction. Bearings with precision degree 5 or over should be applied in the cases. Normally the following bearings are applied: [Deep Groove Ball Bearings, Angular Contact Ball Bearings, Cylindrical Roller Bearings]
Rigidity	Those can satisfy the rigidity of mechanical shaft system. [When bearing carrying load, the contact surface between the rolling elements an the raceways can have elastic deformation. "High rigidity" means such elastic deformation shall occurs in smaller amount.]	

Items of Analyses		Methods of selection
The relative leaning of the inner ring and outer ring	Reason of leading to the relative leaning of the inner ring and outer ring must be analyzed (such as the load - induced bending of the shaft, poor precision of the shaft and housing or mounting error), and the bearings that fit these conditions should be chosen. [The permissible sloping angle is indicated in the notes to the tables of bearing dimensions]	If the relative leaning between the inner ring and outer ring is too big, the inside load thereof shall do harm to the bearings. So bearing types that can carry this leaning should be chosen. Normally, the allowable sloping angle increased with the following order: [Cylindrical Roller Bearings, Tapered Roller Bearing, Deep Groove Ball Bearings (Angular Contact Ball Bearings), Thrust Ball (Spherical Roller) Bearings]
Mounting and dismounting	Check the frequency and methods of mounting and dismounting of the bearings regularly.	If mounting and dismounting frequently, choosing Cylindrical roller bearings with separable inner ring and outer ring, needle roller bearings and tapered roller bearings is comparatively convenient. With adapter or withdrawal sleeve, self-aligning ball bearing with tapered bore and spherical roller bearings with tapered bore are convenient for mounting and dismounting.

The Selection of bearing Collocation

Normally, the shaft is supported by two bearings in radial and axial directions. At the moment , one side of the bearings is called the fix-end bearing which carries the loads both in radial ans. The other one is called the free-end bearing that only carries the radial load and the bearing can comparatively move in the axial direction in order to solve the problems of expansion of the shaft caused by changed in the temperature and the clearance error in mounting.

For the fix-end bearing, it must be chosen from which the axial movement can be prevented. For the free-end bearing, it must be chosen to use its sliding surface to make axial movement (such as cylindrical roller bearings) or use its mounting surface to move (such as radial ball bearings). On the comparatively short shaft, if there are no differences between the two bearings, the bearings that only move in the fixed single axial direction (such as radial thrust ball bearings) are preferable.

Rolling Bearings

Bearings on the fixing end and the free end

Content		Applicable bearing types
Bearings on the fixed end	Fix the bearing in the axial direction. Choose bearings that can carry both the radial load and the axial load. In order to carry double-direction axial load, strength must be considered according to the amount of the axial load while mounting.	Deep groove ball bearings Combined angular contact ball bearings Self-aligning ball bearings Cylindrical roller bearings with flanges (NUP and NH types.) Double-row tapered roller bearings Spherical roller bearings
Bearings on the free end	The bearing must adapt to the shaft expansion caused by the changes in temperature while working and adjust the bearing position in the axial direction. Only the bearing with separable inner ring and outer ring that can carry radial load should be chosen. With non-separable bearings, there should be a clearance between the outer ring and housing in order to adapt the bearing to the shaft expansion in the axial direction. Sometimes, the adaptation is achieved with the contact surface between the shaft and the inner ring.	Separable cylindrical roller bearings (NU or N type) Non-separable types Deep groove ball bearings Combined angular contact ball bearings (back-to-back arrangement) Double-row angular contact ball bearings Self-aligning ball bearings Double-row tapered roller bearings (3700 type) Spherical roller bearings
Regardless of fixed end or free end	When the distance between the two bearings is small, and the effects of shaft expansion are not important, two angular contact ball bearings or tapered roller bearings that can carry axial load can be used together in face-to-face or back-to-back arrangement. Use screw nut or filling piece to adjust the axial clearance after mounting.	Deep groove ball bearings Angular contact ball bearings Self-aligning ball bearings Cylindrical roller bearings (NJ and NF types) Tapered roller bearings Spherical roller bearings
Vertical shaft	Bearings that can carry both radial load and axial load should be chosen for the fixing end. If the axial load is too big, use the combination of thrust bearings and radial bearing. Similarly, only bearings that can carry radial load should be used to adapt to the shaft expansion.	For fixed end Combined angular contact ball bearing (back-to-back arrangement) Double-row tapered roller bearings (3700 type) Combined thrust bearing and radial bearing arrangements

The Specification of Bearing Collocation

Bearing collocation		Application abstracts	Application position
Fixed-end	Free-end		
		·Suitable for carrying larger axial load in double directions ·Use the stacking mount angular contact ball bearing to replace double-row angular contact ball bearing in the fixing-end.	Worm and gear Reducer
		·Suitable for the situation of mounting error and shaft deflection. ·Not only can carry large radial load, but also can carry the axial load with certain limits	Rolling mill Reducer of table rolls Walking wheel of bridge crane
		·Wide applied in high speed rotation. ·Not suitable for the situation that shaft deflection and bearing eccentricity might happen.	Medium-sized motor Air-blower
		·Suitable for the situation of high speed rotation, heavy axial load or shock load. ·Suitable for the interference fit required for inner ring and outer ring, because of separable bearings. ·Not suitable for the situation that shaft deflection and bearing eccentricity might happen.	Main electric motor of railway vehicle
		·Suitable for the situation that the axial load is not very large. ·Suitable for the interference fit required for inner ring and outer ring	Calendar roll of papermaking Vehicle shaft of Diesel locomotive

The Specification of Bearing Collocation

Bearing collocation		Application abstracts	Application position
Fixed-end	Free-end		
		<ul style="list-style-type: none"> ·Suitable for the high speed rotation and the situation that the radial load is large and the axial load exists at the same time ·In order to make deep groove ball bearings free from radial load, there is a gap between outer ring and housing. 	Transmission of diesel locomotive
		<ul style="list-style-type: none"> ·Suitable for carrying large load or shock load ·This application requires the high rigidity of the fixing-end and bearings are mounted in back-to-back arrangement and pre-loaded ·This application also requires to improve the precision of shaft and housing and reduce mounting error 	Rolling mill Lathe spindle

Bearing collocation	Application abstracts	Application position
Regardless of fix-end or free-end		
	<ul style="list-style-type: none"> ·Normally used in small-size mechanisms or for carrying small load ·When applying pre-load, a spring or shim, the thickness of which has been adjusted, can be used on one side of outer ring end face 	Small-sized motor Small-sized reducer Small-sized pump
 back-to-back arrangement face-to-face arrangement	<ul style="list-style-type: none"> ·In order to improve the rigidity of shaft through pre-load application. Widely used in the situation of high rotation speed and large axial load. ·Back-to-back arrangement is fit for carrying torque. ·When applying pre-load, a spring or shim, the thickness of which has been adjusted, can be used on one side of outer ring end face 	Machine tool spindle

Bearing collocation		Application abstracts	Application position
Regardless of fix-end or free-end			
		<ul style="list-style-type: none"> ·Suitable for carrying large load or shock load ·Suitable for improving the rigidity of shaft through pre-loading ·Back to back arrangement is in order to carry torque. ·Face-to-face arrangement is convenient for mounting when inner ring requires interference fit. Suitable for the situation of mounting error ·Pay attention to the adjustment of pre-load when pre-load is applied. 	Reducer Axle shaft of automobile

Bearing collocation	Application abstracts	Application position
Vertical shaft		
	<ul style="list-style-type: none"> ·Use stacking mount angular contact ball bearing in fixing end, using cylindrical bearing in free end. Suitable for high speed rotation. 	Vertical motor Vertical pump

The Specification of Bearing Collocation

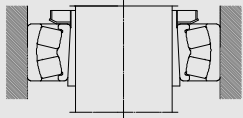
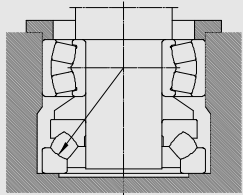
Bearing collocation	Application abstracts	Application position
Vertical shaft		
	·Suitable for low speed, heavy load and the axial load is greater than radial load. ·Suitable for the situation that can generate the bending of shaft and eccentricity.	Central shaft of crane Vertical pump
		

Basic Dynamic Load Rating

Basic dynamic load rating indicates the fatigue resistant capacity (i.e. load carrying capacity). It indicates that with pure radial load (for radial bearings) applied, and under the condition of inner ring rotating and fixed outer ring (or vice versa), the basic rating life can reach 1 million rotations. The basic load rating for radial bearings and thrust bearing is called radial basic load rating respectively, indicated by Cr and Ca, whose values are provided in the bearing dimension tables.

Basic life rating

Formula (1) shows the relations among basic dynamic load rating, equivalent dynamic load raign and basic life rating. When the bearing rotates in constant speed, it is more convenient to express the life rating in time, as shown in formula (2).

In addition, for railway vehicles or automobiles, it is more common to use distance of movement (km) to express the life of relative bearings, as shown in formula (3).

(Total rotation number)

$$L_{10} = \left(\frac{C}{P}\right)^p \dots\dots\dots (1)$$

(Time)

$$L_{10h} = \left(\frac{10^6}{60n}\right)^p \dots\dots\dots (2)$$

(Distance of movement)

$$L_{10s} = \pi D L_{10} \dots\dots\dots (3)$$

Where

- L_{10} basic life rating, 10⁶ rotations
- L_{10h} basic life rating, h
- L_{10s} basic life rating, km
- P: equivalent dynamic load rating, N{kgf}
- C: basic dynamic load rating, N{kgf}
- n: rotation speed, rpm
- p: life index, rpm
- ball bearing.....P=3 $\frac{10}{3}$
- roller bearing.....P=
- D: diameter of the wheel or tire, mm

Therefore, we assume the working conditions of the bearing are: equivalent dynamic load is P, rotation speed is n, then the basic dynamic load rating that satisfies the design requirement of the bearing can be calculated with formula (4). From the dimension tables, we can select the bearing that can meet the requirement of value C, then we can define the dimension of the bearing.

$$C = P \left(L_{10h} \times \frac{60n}{10^6} \right)^{\frac{1}{p}} \dots\dots\dots (4)$$

Use life factor (fh) and speed factor (fn) and get the following formula:

$$L_{10h} = 500fh^p \dots\dots\dots (5)$$

Life factor:

$$fh = fn \frac{C}{P} \dots\dots\dots (6)$$

The Selection of Bearing Dimension

Bearing Life

When bearing rotating while carrying load, material fatigue shall happen even under normal operating conditions due to the effects of alternating load on the raceways of rings and the rolling surface of the rolling elements, and it will cause scaling damage to the raceways and the sliding surface (called flaking of spalling).

The total number of rotations before such scaling happens is called the "(Fatigue) life" of the bearing.

The bearing (fatigue) life varies greatly, even if those with the same structure, dimensions, materials and manufacturing processes under the same rotation conditions.

Because the material fatigue is of diversity, it must be considered statistically. Suppose a group of bearings of the same specification are operated individually under the same working conditions. After a certain period of time, the total rotation which 90% bearing not occurs rolling fatigue is called "Bearing's basic rating life" (namely, the life with 90% reliability). When the bearings rotate at constant speed, the life can also be expressed with total rotation time.

In fact, however, other damage or impair may happen besides fatigue scaling.

The damage of impair may be avoided by choosing the correct bearing, mounting method and lubrication.

Rolling Bearings

Speed factor:

$$f_n = \left(\frac{10^6}{500 \times 60n} \right)^{\frac{1}{p}}$$

$$= (0.03n)^{\frac{1}{p}} \dots\dots\dots (7)$$

We can easily get f_h , f_n and L_{10h} with the calculated figure [Reference figure].

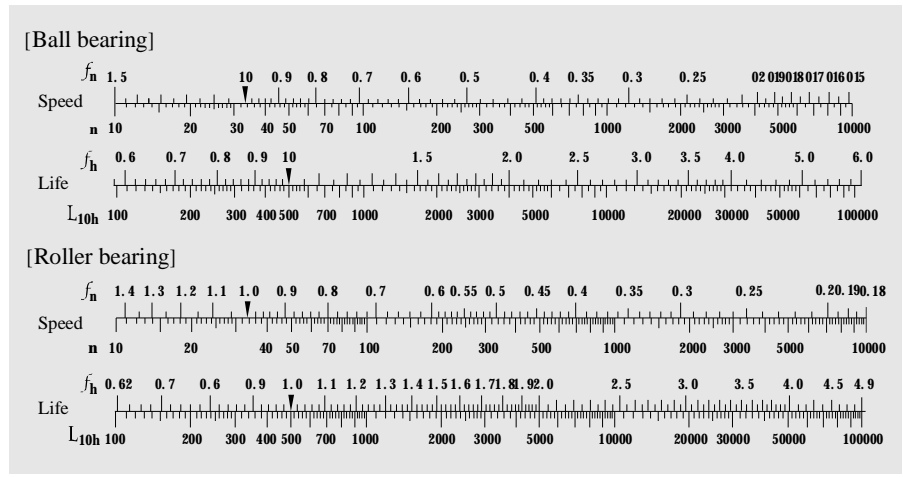

The Modified Basic Dynamic Load Rating Based on Temperature and Stabilizing Treatment of Bearing

When applied in high temperature, the internal microstructure in the material shall change and the hardness shall be decreased, while the basic dynamic load rating shall be smaller than in normal temperature. And if the changed microstructure in the material shall not recover even when the bearing is put back in the normal temperature again. Therefore, under high temperature conditions, the basic dynamic load ratings must be multiplied by the temperature factors listed in table 1 for correction purpose.

Table 1 Temperature factors

Working temperature °C	125	150	175	200	250
Temperature factor (fT)	1	1	0.95	0.90	0.75

If working in the temperature of over 120°C for a very long time, the dimensions for bearings processed by normal heat treatment shall change greatly, measures must be taken to stabilized the dimensions.

The code names for these stabilization measures and the applicable temperature ranges are provided in Table 2. The hardness of the

bearing, however, shall be reduced with the above treatment. Sometimes, the basic dynamic load rating will also decrease.

Table 2 Measures for dimensional stabilization

Code name	Relative temperature range
S ₀	Over 100°C to 150°C
S ₁	Over 150°C to 200°C
S ₂	Over 200°C to 250°C

Correction of Life Rating

Formula (1) shows the basic life rating (L_{10h}) of 90% reliability. Based on different applications, high-reliability life with reliability being over 90% will be required under come conditions.

In addition, special materials sometimes shall elongate the bearing life, even lubrication or differences in working conditions can have effects on bearing life. The bearing life after taking these factors into consideration is called the corrected life rating, which is calculated with formula (8).

$$L_{na} = a_1 a_2 a_3 L_{10} \dots\dots\dots (8)$$

Where ,

L_{na} : corrected life rating, 10^6 revolutions

(i.e. the life with 100-n% reliability (n% loss rate) after taking the bearing features and operating conditions into consideration.)

L_{10} : basic life rating , 10^6 rotations (reliability of 90%)

- a_1 : Reliability life correction factor referring to (1)
- a_2 : Special raw-material performance life correction factor..... referring to (2)
- a_3 : Bearing performance correction factor in application condition..... referring to (3)

Note: When selecting bearing dimensions according reliability over 90% L_{na} , shall pay special attention to the strength of shaft and housing.

(1) Reliability factor a_1

When calculating the corrected life rating for those with reliability of greater than 90% (i.e. the loss if not greater than 10%), factor a_1 in Table 3 should be employed.

(1) Reliability factor a_1

When calculating the corrected life rating for those with reliability of greater than 90% (i.e. the loss if not greater than 10%), factor a_1 in Table 3 should be employed.

Table 3 Reliability factor a_1

Reliability, %	L_{na}	a_1
90	L_{10a}	1
95	L_{5a}	0.62
96	L_{4a}	0.53
97	L_{3a}	0.44
98	L_{2a}	0.33
99	L_{1a}	0.21

(2) Special raw-material performance life correction factor a_2

The bearing characteristics relate to service life may vary with the bearing materials (type of steel, quality), processing technique and design. In these cases, the factor a_1 should be used for correction purpose.

If the material is high quality vacuum degassed

Rolling Bearings

bearing steel or with quite minimum amount of inclusion, $a_2 > 1$.
For normal bearing material steel, $a_2 = 1$.

(3) Bearing performance correction factor in application condition a_3
This factor a_3 is used for correction purpose when the bearings are applied in conditions (especially lubrication) that shall affect the service life of the bearings.

Can select $a_3 = 1$ under normal lubricating conditions, and choose $a_3 > 1$ if in excellent conditions.
Under the following circumstances, choose $a_3 < 1$:

- If the kinematic viscosity of the lubricant decreases during the working time of the bearing:
Ball bearings.....less than 13mm²/s {13ces}
Roller bearings.....less than 20mm²/s {20ces}
- When the rotational speed is extremely low, the product of the pitch diameter of the rolling

elements and the rotational speed is less than 10000.

- When the lubricant mix with impurities.
- Large relative lean between inner ring and outer ring
[Note] When the hardness decreases under high temperature circumstance circumstances, the basic dynamic load rating must be corrected (see Table 1)

The Bearing Life Required by the Machinery

The requirement for bearing life must be reasonably defined. If the requirement is too high, the dimensions must be too big and the machine shall be respectively too heavy that lead to the disconomy of the machine. If the requirement is too low, however, the bearing must be replaced very often. Normally, the bearing life may be defined according to the period of overhaul. The recommended life values for various bearings are provided in Table 4.

Table 4 Required Bearing Life (for reference)

Application conditions	Machines	Time (h)
Running in short time or discontinuously	Household electronic appliances, electrical tools, agricultural machines, winding engines	4000-8000
Not usually used but running with high reliability	Air conditioner motors, construction, machines, belt machines, elevators	8000-12000
Used discontinuously but running for long time periods	Mill roll necks, small motors, cranes	8000-12000
	General industrial motors, general gear devices	12000-20000
	Machine tools, vibration screens, crushers Compressors, pumps, important gear devices	20000-30000 40000-60000

Application conditions	Machines	Time (h)
Normally running over 8 hours daily or continuously for long time periods	Automatic elevators	12000-20000
	Centrifugal machines, air-conditioning equipment, air-blowers, wood processing machines, shafts for railway vehicles	20000-30000
	Large motors, mining elevators, main motors for railway vehicles, locomotives	40000-60000
	Paper-making machines	100000-200000
24-hour continuous running without stoppage	Running water equipment, power station equipment, mining drainage works	100000-200000

Equivalent Dynamic Load

Bearings usually carry the combination of radial load and axial load, and the load conditions are varied, such as the changes in the amount and so on.

Therefore, the actual load can not be directly compared with its dynamic load rating.

In this case, it is necessary to convert the actual load into a perceived load with definite amount and direction that passes the bearing center. The bearing with this perceived load shall have the same life as with actual load and the same rotational speed.

This perceived load after conversion is called the equivalent dynamic load, indicated by P.

The calculation of equivalent dynamic load

the equivalent dynamic load of the radial bearings and thrust bearings ($\alpha \neq 90^\circ C$) can be calculated with formula below:

$$P = X F_r + Y F_a \dots\dots\dots (9)$$

Where,

P: equivalent dynamic load, n {kgf}

(For radial bearings, it is expressed as
Pr: radial dynamic load
For thrust bearings, it is expressed as
Pa: axial dynamic load)

Fr: radial load, N {kgf}

Fa: axial load, N {kgf}

X: radial load factor

Y: axial load factor

(Load factors X and Y are given in the bearing dimension tables.)

For single-row radial bearings, when $F_a / F_r \leq e$, let X=1, Y=0

Hence, in this cage equivalent dynamic load $P_r = F_r$

[e indicates the critical value which is given in the bearing dimension tables.]

For single-row angular contact ball bearings and tapered roller bearings, as shown in Figure 1, since the axial component of force shall happen when the bearing carries radial load, normally two bearings are used in face-to-face or back-to-back arrangements.

Rolling Bearings

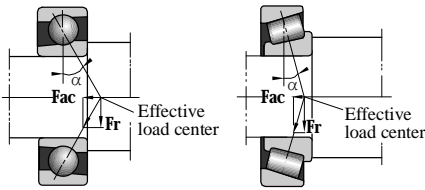

[The location dimensions of effective load center are listed in the bearing dimension table]

Figure 1 Axial component of force

The axial component of force can be calculated with the following formula:

$$F_{ac} = \frac{F_r}{2Y} \dots\dots\dots (10)$$

The calculation method for the equivalent dynamic load of these bearings when they carry radial load and outside axial load are shown in Table 5.

Thrust ball bearings with $\alpha=90^\circ$ can only carry axial load, therefore the equivalent dynamic load $P_a=F_a$.

The equivalent dynamic load of thrust spherical roller bearing can be calculated with following formula:

$$P_a = F_a + 1.2F_r \dots\dots\dots (11)$$

Where, $\frac{F_r}{F_a} \leq 0.55$

Table 5 Calculation of equivalent dynamic load for two single-row angular contact ball bearings or tapered roller bearings matched in face-to-face or back-to back arrangement

Bearings collocations		Load conditions	Bearing	Axial load	Equivalent dynamic load
Back Collocation	Face Collocation				
		$\frac{F_{rB}}{2Y_B} + K_a \geq \frac{F_{rA}}{2Y_A}$	Bearing A	—	$P_A = XF_{rA} + Y_A \left(\frac{F_{rB}}{2Y_B} + K_a \right)$ $P_A < F_{rA}$ When, let $P_A = F_{rA}$
			Bearing B	—	$P_B = F_{rB}$
		$\frac{F_{rB}}{2Y_B} + K_a < \frac{F_{rA}}{2Y_A}$	Bearing A	—	$P_A = F_{rA}$
			Bearing B	$\frac{F_{rA}}{2Y_A} - K_a$	$P_B = XF_{rB} + Y_B \left(\frac{F_{rA}}{2Y_A} - K_a \right)$ $P_B < F_{rB}$ When, let $P_B = F_{rB}$

Bearings collocations		Load conditions	Bearing	Axial load	Equivalent dynamic load
Back Collocation	Face Collocation				
		$\frac{F_{rB}}{2Y_B} \leq K_a + \frac{F_{rA}}{2Y_A}$	Bearing A	—	$P_A = F_{rA}$
			Bearing B	$\frac{F_{rA}}{2Y_A} + K_a$	$P_B = XF_{rB} + Y_B \left(\frac{F_{rA}}{2Y_A} + K_a \right)$ $P_B < F_{rB}$ When, let $P_B = F_{rB}$
		$\frac{F_{rB}}{2Y_B} > \frac{F_{rA}}{2Y_A} + K_a$	Bearing A	$\frac{F_{rB}}{2Y_B} - K_a$	$P_A = XF_{rA} + Y_A \left(\frac{F_{rB}}{2Y_B} - K_a \right)$ $P_A < F_{rA}$ When, let $P_A = F_{rA}$
			Bearing B	—	$P_B = F_{rB}$

Note:

1. Applicable to situations where the internal clearance and pre-load equal 0 when the bearing is running.
2. The radial load is positive although it is in the opposite direction of the arrow in the above figure.

The average equivalent dynamic load when the load changes

When the bearing carries a changing load in either amount or direction, it is necessary to calculate the average equivalent dynamic load which makes the bearing have the same life under actual changing circumstances.

The calculation methods for average equivalent dynamic load in changing situations are shown in (1) to (4).

In addition, as shown in Figure 5, the average equivalent dynamic load can be calculated with formula (16) when the static load rotational load are carried simultaneously.

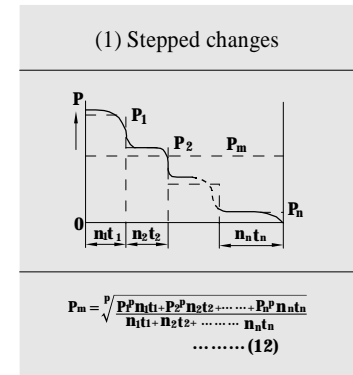

Rolling Bearings

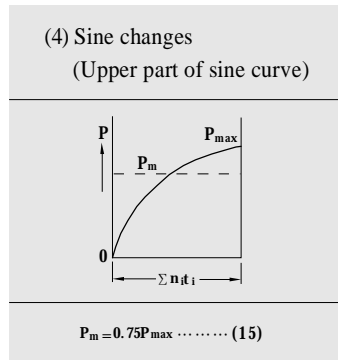
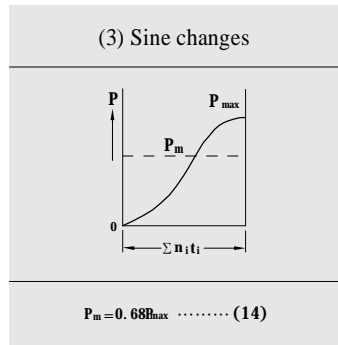
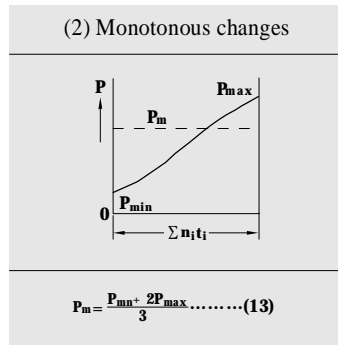

From (1) to (4) ,

- P_m : Average Equivalent Dynamic Load, N
- P_1 : {kgf}
- AEDL when rotational speed = n_1 and effective time = t_1 , N {kgf}
- P_2 : AEDL when rotational speed = n_2 and effective time = t_2 , N {kgf}
- P_n : AEDL when rotational speed = n_n and effective time = t_n , N {kgf}
- P_{min} : the minimum AEDL, N {kgf}
- P_{max} : the maximum AEDL, N {kgf}
- $\Sigma n_i t_i$: $t_q \sim t_i$ the total rotation number within the time
- P : life index
- For ball bearings, $p=3$
- For roller bearings, $p= \frac{10}{3}$

(Reference) Average rotation speed (n_m) can be calculated with the following formula:

$$n_m = \frac{n_1 t_1 + n_2 t_2 + \dots + n_n t_n}{t_1 + t_2 + \dots + t_n}$$

(5) Static load and rotational load working together

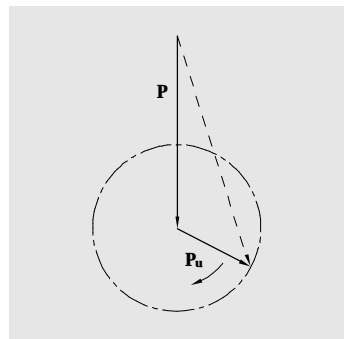

$$P_m = f_m (P + P_u) \dots \dots \dots (16)$$

Where,

- P_m : average equivalent dynamic load, N {kgf}
- f_m : factor (Figure 2)
- P : static load, N {kgf}
- P_u : rotational load, N {kgf}

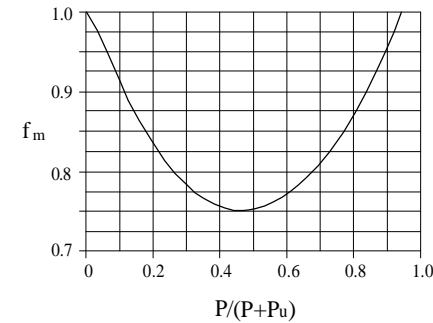

Figure 2 Factor f_m

Basic Static Load Rating

Partial permanent deformation will happen to the contact surfaces of the rolling elements and raceways when the bearing carries too heavy the static load or work at extremely low rotational speed. The amount of deformation shall increase with the growing load and shall affect the normal rotation when it exceeds certain limit.

The basic static load rating means the static load which can produce stress in the center of contact surface between the rolling elements carrying the maximum load and the raceways, the contact stress can be calculated as the following:

- Self-aligning ball bearings
4600Mpa {469kgf/sq.mm²}
- Other ball bearings
4200Mpa {429kgf/sq.mm²}
- Roller bearings
4000Mpa {408kgf/sq.mm²}

The total amount of permanent deformation of the rolling elements and raceway under such stress equaling 0.0001 times of the diameter of the rolling elements.

For radial bearings and thrust bearings, the basic static load rating is called radial basic static load rating and the axial basic static load rating, indicated by C_{or} and C_{oa} respectively. The values of them are given in the bearings dimension tables.

Equivalent Static Load

Equivalent static load rating is a perceived load. When the bearing is motionless or rotates at extremely low speed, the contact stress in the center of the surface between the rolling elements carrying maximum load and the raceway under such perceived load shall be the same as that will happen in actual load conditions.

The radial load and axial load passing the bearing central line is used as the equivalent static load rating of radial bearing and axial bearing respectively.

Equivalent static load rating can be calculated with the following formula:

[Radial bearing].....can be calculated by two formula below, choose the larger value.

$$P_{or} = X_o F_r + Y_o F_a \dots \dots \dots (17)$$

$$P_{or} = F_r \dots \dots \dots (18)$$

[Thrust bearing]

($\alpha \neq **^\circ$)

$$P_{oa} = X_o F_r + F_a \dots \dots \dots (19)$$

(However, the accuracy decreased when $F_a < X_o F_a$)

($\alpha = **^\circ$)

$$P_{oa} = F_a \dots \dots \dots (20)$$

Rolling Bearings

Where,

- Por: radial equivalent static load rating, N {kgf}
- Poa: axial equivalent static load rating, N {kgf}
- Fr: radial load, N {kgf}
- Fa: axial load, N {kgf}
- Xo: radial static load factor
- Yo: axial static load factor (Static factor Xo and Yo are given in the bearing dimension tables.)

bearing, the use limit of the bearing restricted by the above-mentioned permanent deformation (the amount of partial surface hollow) will vary with the requirements on the functionality and the application conditions of the bearing.

Therefore, an empirical safety factor is defined in order to analyze the safe level of the basic static load rating.

$$f_s = \frac{C_o}{P_o} \dots\dots\dots (21)$$

Where,

- fs: safety factor (Table 6)
- Co: basic static load rating, N {kgf}
- Po: equivalent static load, N {kgf}

Safety Factors

Although the permissible equivalent static load depends on the basic static load rating of the

Table 6 Safety factor

Application conditions		fs (minimum)	
		Ball bearing	Roller bearing
Rotating in normal way	High rotational precision	2	3
	Under normal conditions	1	1.5
	With shock load	1.5	3
Rotating rarely (sometimes oscillating)	Under normal conditions	0.5	1
	With shock load or unevenly-distributed load	1	2

[Note]: For thrust spherical roller bearings, let $f_s \geq 4$.

The Preload of Bearing

During working and under the running condition, the bearings usually have proper internal clearance. In order to improve the rigidity or ruing accuracy of bearing under different working conditions, the bearing is preloaded to make it with certain negative internal clearance, i.e. taking some measures to generate certain predeformation among rolling elements, inner ring and outer ring to keep the condition of being pressed between inner ring and outer ring. This process measure is called pretension. It is normally applicable for angular contact ball bearing and tapered roller bearing.

Purpose of Bearing Preload

To improve the axial and radial positioning accuracy of shaft and reduce the run-out of shaft.

To improve the rigidity of bearing

To avoid the bearing noise generated by vibration and resonance vibration

To keep correct relative position among rolling elements and rings.

Types of Preload

Radial or axial pretension can be adopted according to different bearing type. The pretension is realized by applying preload between two pcs of bearings and make inner ring and outer ring have relative displacement.

Positional Preload

In order to fix the relative axial position of bearing and improve the rigidity of bearing

Constant Pressure Preload

The pretension is realized by a spring. Therefore, pre-pressure can be kept steadily even though the position between bearings may change due to temperature rise or load during operation.

Cylindrical bearing: radial preload.

Thrust bearing: axial preload.

Single-row angular contact ball bearing and tapered roller bearing:

Generally, they're applied axial preload and used with the other bearing of the same type in face-to-face arrangement or back-to-back arrangement.

Deep groove ball is usually applied axial load. Normally, preload is adjusted under certain ambient temperature during mounting. (or preset according to this temperature). During operating, if the temperature rise of shaft is greater than bearing block, the preload will be increased. And the preload amount of face-to-face arrangement increases greater than the preload amount of back-to-back arrangement.

Rolling Bearings

Bearing Data

Main Bearing Dimensions

The main dimensions of bearings indicate the boundary dimensions of inner ring, outer ring, width or height and chamfer and others that are used to describe the outline of the bearing. They are the necessary dimensions required for the mounting on the shaft or in the housing. These main dimensions have been standardized by international standard (ISO15). GB307 (main dimensions for rolling bearings) are also based on ISO standards.

The national standards have defined the main dimensions according to types of radial bearings (except the regulations for tapered roller bearings) and thrust bearings. The details are provided in the bearing catalogue.

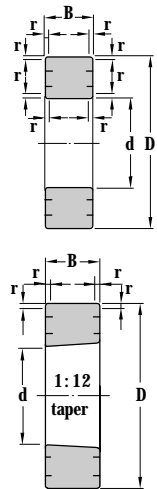

- (1) Radial bearing
(Excluding tapered roller bearing)
d: bearing nominal bore diameter
D: bearing nominal outer diameter
B: bearing nominal width
r: inner and outer rings chamfer dimension

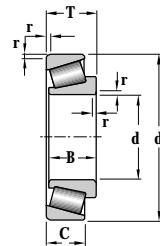

- (2) Tapered roller bearing
d: bearing nominal bore diameter
D: bearing nominal outer diameter
T: bearing nominal width (assembly width)
B: inner ring nominal width
C: outer ring nominal width
r: inner and outer rings chamfer dimension

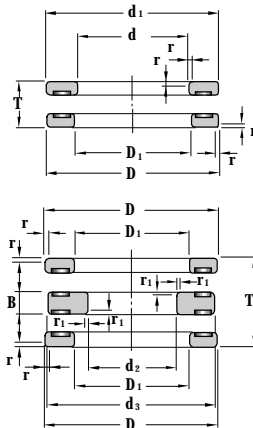

- (3) Thrust bearing
(single direction, double direction)
Thrust bearing
(Plain housing washer type)
d: Shaft washer nominal bore diameter
d1: Shaft washer nominal outer diameter 2) of inner ring

- d2: Central shaft washer nominal bore diameter
d3: Central shaft washer nominal outer diameter 2)
D: Housing washer nominal out diameter
D1: Housing washer nominal bore diameter 1)
T: Nominal height of single direction bearing
T1: Nominal height of double direction bearing
B: Central shaft washer height
r: Shaft washer and housing washer chamfer dimension 1)
r1: Central shaft washer chamfer dimension 1)

[Note]

- 1). The minimum value is listed in bearing dimension tables
- 2). The maximum value is listed in bearing dimension tables.

Bearing Tolerance

Rolling bearing precision class has been standardized and has been classified into 6 levels of P0, P6X, P6, P5, P4 and P2.

The precision level increases beginning from P0. P0 class is applicable for normal purpose. When bearings are working in such conditions or circumstances as described in Table 1, P5 or even higher precision is needed.

Although the above mentioned precision class is made based on the ISO standard, it is named differently in some countries.

Applicable precision classes to all kinds of bearing types and comparisons among different countries' standards are listed in Table 2.

- Dimension precision (relative to axle and housing mounting)
 - Bore diameter, outer diameter, width and permissible deviation of assembly width
 - Permissible deviation of roller group inner and outer inscribed circle diameters
 - Permissible limit value of chamfer dimension
 - Permissible variation of width
 - Permissible deviation and variation of tapered bore
- Rotation precision (relative to rotation object's runout)
 - Permissible deviation and variation of tapered bore
 - Permissible radial and axial runout of inner and ring and outer ring
 - Permissible horizontal runout of inner ring
 - Permissible variation of outer diameter surface leaning slop
 - Permissible raceway thickness variation of thrust bearing

Rolling Bearings

Table 1: Application examples of precision bearing

Performance requirements	Application	Applicable precision class
High runout precision of rolling elements is required	Acoustics, video device spindles(video, recorder) Radar, paraboloid antenna rotating axle Machine tools spindle Computer, disc driver spindle Roll neck for aluminum foil mill Bearings for multi-process rolling mills	P5,P4 P4 P5,P4,P2,ABEC9 P5,P4,P2,ABEC9 P5 P4
High rotation speed	Superchargers Jet propelled generator spindle, auxiliary machine Centrifugal separator Hydraulic natural gas pumps Turbine molecular pump spindle, protection bearing Machine tool spindle Tensioners	P5,P4 P5,P4 P5,P4 P5 P5,P4 P5,P4,P2,ABEC9 P5,P4
Low friction and small friction variation is required	Devices for control (synchronism motor, servo motor, gyro gimbal) Meters and instruments Machine tool spindles	P4,ABMA 7P P5 P5,P4,P2,ABEC9

Tolerance symbols

Boundary dimension symbols (Figure 1)

- d: Nominal bearing bore diameter
- d1: Basic diameter of basic tapered hole on theoretical big end
- Δd_s : Deviation of single bore diameter
- Δd_{mp} : Deviation of mean inner diameter on the single plain (for tapered hole, Δd_{mp} only refers to theoretical small end of inner bore)
- Δd_{1mp} : Mean inner diameter deviation of basic tapered hole on theoretical big end
- Δd_p : Amount of change of inner diameter on the single radial plain
- V_{dmp} : Mean inner diameter amount of change (only suitable for cylindrical bore)
- α : Nominal half taper angle
- D: Nominal bearing outer diameter
- D1: Nominal outer diameter of outer ring's flange
- ΔD_s : Single outer diameter deviation
- ΔD_{mp} : Mean outer diameter deviation on the single plain
- ΔD_{1s} : Single outer diameter deviation of outer ring's flange
- ΔD_p : Outer diameter variation on the single radial plain
- ΔD_{mp} : Mean variation of outer diameter
- B: Inner ring nominal width
- ΔB_s : Single width deviation of inner ring
- V_B : Width variation of inner ring
- C: Nominal width of outer ring
- C1: Nominal width of outer ring flange
- ΔC_s : Single width deviation of outer ring
- ΔC_{1s} : Single width deviation of outer ring flange
- V_C : Width variation of outer ring
- V_{C1s} : Width variation of outer ring flange
- Kia: Radial runout of assembled bearing inner ring
- Kea: Radial runout of assembled bearing outer ring
- Sd: Inner ring reference face (back face) runout with bore
- SD1: Inclination variation of outer diameter generatrix with reference face (back face)
- Sia: Inclination variation of outer diameter generatrix to the flange back face
- Sea: Runout of assembly bearing's inner ring end face (back face) to the race way
- Sea1: Runout of flange back face to raceway of assembly bearings

Table 2: Bearing type and applicable precision class

Bearing type	Applicable standard	Applicable precision class					
		P0	—	P6	P5	P4	P2
Deep groove ball bearings	GB307	P0	—	P6	P5	P4	P2
Angular contact ball bearings		P0	—	P6	P5	P4	P2
Self-aligning ball bearing		P0	—	—	—	—	—
Cylindrical roller bearings		P0	—	P6	P5	P4	P2
Tapered roller bearings	Metric series (single row)	P0	P6X	P6	P5	P4	—
	Metric series	P0	—	—	—	—	—
(double-row, four-row) inch series	SB/CO/T10-89	Class4	—	Class2	Class3	Class0	Class0
Spherical roller bearings	GB307	P0	—	—	—	—	—
Thrust ball bearings		P0	—	P6	P5	P4	—
Spherical thrust roller bearings		P0	—	—	—	—	—

Rolling Bearings

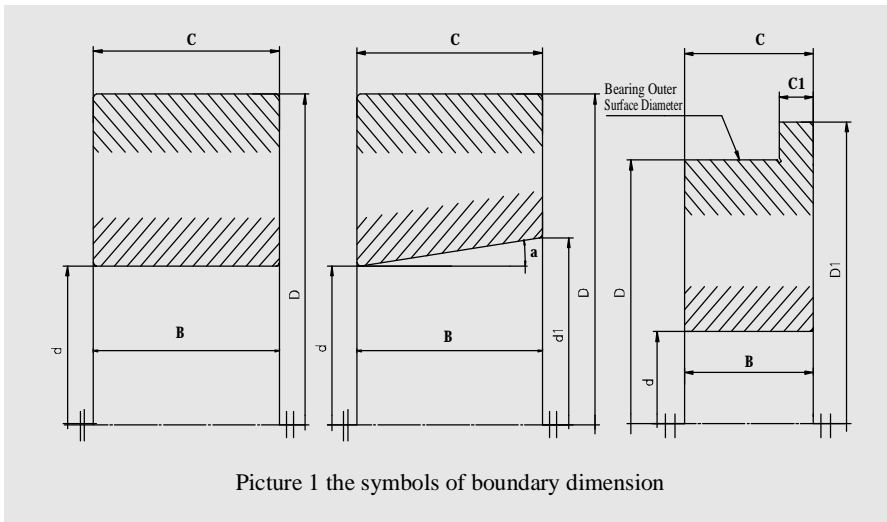

Picture 1 the symbols of boundary dimension

Tolerance value
 Radial bearing (excluding tapered roller bearings)
 Tolerance of P0 (Table 3, Table 4)

Table 3: Tolerance of Class P0 inner ring

d mm	Δd_{mp}		V _{dp} ²⁾			V _{dmp}	K _{ia}	ΔB_s			V _{Bs}	
			Diameter series					All	Normal	Revision ³⁾		
			9	0, 1	234							
Over	To	High	Low	max			max	max	High	Low		
0.6 ¹⁾	2.5	0	-8	10	8	6	6	10	0	-40	-	12
2.5	10	0	-8	10	8	6	6	10	0	-120	-250	15
10	18	0	-8	10	8	6	6	10	0	-120	-250	20
18	30	0	-10	13	10	8	8	13	0	-120	-250	20
30	50	0	-12	15	12	9	9	15	0	-120	-250	20
50	80	0	-15	19	19	11	11	20	0	-150	-380	25
80	120	0	-20	25	25	15	15	25	0	-200	-380	25
120	180	0	-25	31	31	19	19	30	0	-250	-500	30
180	250	0	-30	38	38	23	23	40	0	-300	-500	30
250	315	0	-35	44	44	26	26	50	0	-350	-500	35
315	400	0	-40	50	50	30	30	60	0	-400	-630	40
400	500	0	-45	56	56	34	34	65	0	-450	-	50
500	630	0	-50	63	63	38	38	70	0	-500	-	60
630	800	0	-75	-	-	-	-	80	0	-750	-	70
800	1000	0	-100	-	-	-	-	90	0	-1000	-	80
1000	1250	0	-125	-	-	-	-	100	0	-1250	-	100
1250	1600	0	-160	-	-	-	-	120	0	-1600	-	120
1600	2000	0	-200	-	-	-	-	140	0	-2000	-	140

[Note]: 1) 0.6mm is included.
 2) The values are not given for bearing diameter of series 7 and 8.
 3) Suitable for inner ring or outer ring of a single bearing in matched pair or stacking mount, also suitable for inner ring of bearings with taper hole d*50mm.

Picture 2 Appended symbols for tapered roller bearings

- T: Nominal width of the bearing
- ΔT_s : Deviation of actual bearing assembly width
- T1: Effective width of cone assembled with master cup
- $\Delta T1_s$: Deviation of single width of cone assembled with master cup
- T2: Effective width of cone assembled with master cup
- $\Delta T2_s$: Deviation of single width of cup assembled with master cone

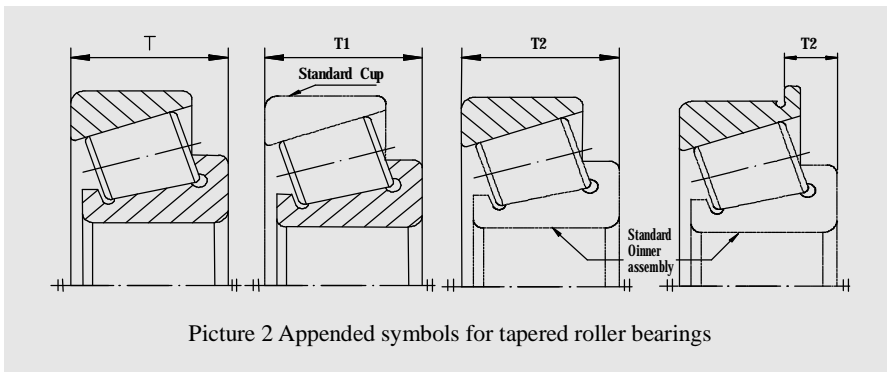

Picture 2 Appended symbols for tapered roller bearings

Rolling Bearings

Table 4: Tolerance of Class P0 outer ring μm

D mm		Δ D _{mp}		V _{Dp} ²⁾⁴⁾				V _{Dmp} ⁴⁾	K _{ea}	Δ C _s Δ C _{1s} ⁵⁾	V _{Cs}		
				Open bearing		Capped bearing					High	Low	max
				9	0, 1	2, 3, 4	2, 3, 4						
Over	To	High	Low	max				max	max	High	Low	max	
2.5 ¹⁾	6	0	-8	10	8	6	10	6	15	Same as the ΔBs and VBS of the same bearing I.D.			
6	18	0	-8	10	8	6	10	6	15				
18	30	0	-9	12	9	7	12	7	15				
30	50	0	-11	14	11	8	16	8	20				
50	80	0	-13	16	13	10	20	10	25				
80	120	0	-15	19	19	11	26	11	35				
120	150	0	-18	23	23	14	30	14	40				
150	180	0	-25	31	31	19	38	19	45				
180	250	0	-30	38	38	23	-	23	50				
250	315	0	-35	44	44	26	-	26	60				
315	400	0	-40	50	50	30	-	30	70				
400	500	0	-45	56	56	34	-	34	80				
500	630	0	-50	63	63	38	-	38	100				
630	800	0	-75	94	94	55	-	55	120				
800	1000	0	-100	125	125	75	-	75	140				
1000	1250	0	-125	-	-	-	-	-	160				
1250	1600	0	-160	-	-	-	-	-	190				
1600	2000	0	-200	-	-	-	-	-	220				
2000	2500	0	-250	-	-	-	-	-	250				

[Note]:

- 1) 2.5mm is included.
- 2) The values are not given for bearing diameter of series 7 and 8.
- 3) The values are not given for bearing diameter of series 9, 0 and 1.
- 4) Suitable for the situation that inner or outer snap ring is not mounted or dismounted.
- 5) Only applicable for deep groove bearings.

Tolerance of P6 (Table 5, Table 6)

Table 5: Tolerance of Class P6 inner ring μm

d mm		Δ d _{mp}		V _{dp} ²⁾			V _{dmp}	K _{ia}	Δ B _s			V _{Bs}
				Diameter series					All	Normal	Revision ³⁾	
				9	0, 1	2 3 4						
Over	To	High	Low	max			max	max	High	Low	max	
0.6 ¹⁾	2.5	0	-7	7	9	5	5	5	0	-40	-	12
2.5	10	0	-7	7	9	5	5	6	0	-120	-250	15
10	18	0	-7	7	9	5	5	7	0	-120	-250	20
18	30	0	-8	8	10	6	6	8	0	-120	-250	20
30	50	0	-10	10	13	8	8	10	0	-120	-250	20
50	80	0	-12	15	15	9	9	10	0	-150	-380	25
80	120	0	-15	19	19	11	11	13	0	-200	-380	25
120	180	0	-18	23	23	14	14	18	0	-250	-500	30
180	250	0	-22	28	28	17	17	20	0	-300	-500	30
250	315	0	-25	31	31	19	19	25	0	-350	-500	35
315	400	0	-30	38	38	23	23	30	0	-400	-630	40
400	500	0	-35	44	44	26	26	35	0	-450	-	45
500	630	0	-40	50	50	30	30	40	0	-500	-	50

[Note]:

- 1) 0.6mm is included.
- 2) The values are not given for bearing diameter series of 7 and 8.
- 3) Suitable for inner ring or outer ring of a single bearing in matched pair or stacking mount, also suitable for inner ring of bearings with taper hole $d \geq 50$ mm.

Rolling Bearings

Table 6: Tolerance of Class P6 outer ring μm

D mm		Δ D _{mp}		V _{Dp} ²⁾⁴⁾				V _{Dmp} ⁴⁾	K _{ea}	ΔC _s	V _{Cs}		
				Open bearing		Capped bearing					ΔC _{1s} ⁵⁾	V _{C1s} ⁵⁾	
				9	0, 1	2, 3, 4	0, 1, 2, 3, 4					High	Low
Over	To	High	Low	max				max	max	High	Low	max	
2.5 ¹⁾	6	0	-7	9	7	5	9	5	8	Same as the ΔBs and VBS of the same bearing I.D.			
6	18	0	-7	9	7	5	9	5	8				
18	30	0	-8	10	8	6	10	6	9				
30	50	0	-9	11	9	7	13	7	10				
50	80	0	-11	14	11	8	16	8	13				
80	120	0	-13	16	16	10	20	10	18				
120	150	0	-15	19	19	11	25	11	20				
150	180	0	-18	23	23	14	30	14	23				
180	250	0	-20	25	25	15	-	15	25				
250	315	0	-25	31	31	19	-	19	30				
315	400	0	-28	35	35	21	-	21	35				
400	500	0	-33	41	41	25	-	25	40				
500	630	0	-38	48	48	29	-	29	50				
630	800	0	-45	56	56	34	-	34	60				
800	1000	0	-60	75	75	45	-	45	75				

[Note]:

- 1) 2.5mm is included.
- 2) The values are not given for bearing diameter of series 7 and 8.
- 3) The values are not given for bearing diameter of series 9.
- 4) Suitable for the situation that inner or outer snap ring is not mounted or dismounted.
- 5) Only applicable for deep groove bearings.

Tolerance of P5 (Table 7, Table 8) μm

Table 7: Tolerance of Class P5 inner ring μm

d mm		Δ d _{mp}		V _{dp} ²⁾		V _{dmp}	K _{ia}	S _d	S _{ia}	Δ B _s			V _{Bs}
				Diameter series						All	Normal	Revision ⁴⁾	
				9	0, 1, 2, 3, 4								
Over	To	High	Low	max		max	max	max	max	High	Low		
0.6 ¹⁾	2.5	0	-5	5	4	3	4	7	7	0	-40	-250	5
2.5	10	0	-5	5	4	3	4	7	7	0	-40	-250	5
10	18	0	-5	5	4	3	4	7	7	0	-80	-250	5
18	30	0	-6	6	5	3	4	8	8	0	-120	-250	5
30	50	0	-8	8	6	4	5	8	8	0	-120	-250	5
50	80	0	-9	9	7	5	5	8	8	0	-150	-250	6
80	120	0	-10	10	8	5	6	9	9	0	-200	-380	7
120	180	0	-13	13	10	7	8	10	10	0	-250	-380	8
180	250	0	-15	15	12	8	10	11	13	0	-300	-500	10
250	315	0	-18	18	14	9	13	13	15	0	-350	-500	13
315	400	0	-23	23	18	12	15	15	20	0	-400	-630	15

[Note]:

- 1) 0.6mm is included.
- 2) The values are not given for bearing diameter series 7 and 8.
- 3) Only suitable for deep groove bearings.
- 4) Suitable for inner ring or outer ring of a single bearing in matched pair or stacking mount, also suitable for inner ring of bearings with taper hole d ≥ 50mm.

Table 8: Tolerance of Class P5 outer ring

μm

D mm		Δ D _{mp}		V _{Dp} ²⁾³⁾		V _{Dmp}	K _{ea}	S _D ⁴⁾	S _{ea} ⁴⁾⁵⁾	S _{ea1} ⁴⁾⁵⁾	Δ C _s		V _{Cs}	
				Diameter series							Δ C _{1s} ⁵⁾	V _{C_{1s}} ⁵⁾		
				9	0, 2, 3, 4									
Over	To	High	Low	max		max	max	max	max	max	High	Low	max	
2.5 ¹⁾	6	0	-5	5	4	3	5	8	8	11	Same as the ΔBs of the same bearing I.D.		5	
6	18	0	-5	5	4	3	5	8	8	11				5
18	30	0	-6	6	5	3	6	8	8	11				5
30	50	0	-7	7	5	4	7	8	8	11				5
50	80	0	-9	9	7	5	8	8	10	14				6
80	120	0	-10	10	8	5	10	9	11	16				8
120	150	0	-11	11	8	6	11	10	13	18				8
150	180	0	-13	13	10	7	13	10	14	20				8
180	250	0	-15	15	11	8	15	11	15	21				10
250	315	0	-18	18	14	9	18	13	18	25				11
315	400	0	-20	20	15	10	20	13	20	28				13
400	500	0	-23	23	17	12	23	15	23	33				15
500	630	0	-28	28	21	14	25	18	25	35				18
630	800	0	-35	35	26	18	30	20	30	42			20	

[Note]:

- 1) 2.5mm is included.
- 2) The values are not given for bearing diameter series 7 and 8.
- 3) The values are not given for closed bearings.
- 4) No suitable for bearings with flanged outer ring.
- 5) Only applicable for deep groove bearings.

Tolerance of P4 (Table 9, Table 10)

Table 9: Tolerance of Class P4 inner ring

μm

d mm		Δ d _{mp}		Δ d _s ²⁾		V _{dp} ²⁾		V _{dmp}	K _{ia}	S _d	S _{ia}	V _{Bs}			V _{Bs}
						Diameter series						All	Normal	Revision ³⁾	
						9	0,1,2,3,4								
Over	To	High	Low	High	Low	max		max	max	max	max	High	Low		
0.6 ¹⁾	2.5	0	-4	0	-4	4	3	2	2.5	3	3	0	-40	-250	2.5
2.5	10	0	-4	0	-4	4	3	2	2.5	3	3	0	-40	-250	2.5
10	18	0	-4	0	-4	4	3	2	2.5	3	3	0	-80	-250	2.5
18	30	0	-5	0	-5	5	4	2.5	3	4	4	0	-120	-250	2.5
30	50	0	-6	0	-6	6	5	3	4	4	4	0	-120	-250	3
50	80	0	-7	0	-7	7	5	3.5	4	5	5	0	-150	-250	4
80	120	0	-8	0	-8	8	6	4	5	5	5	0	-200	-380	4
120	180	0	-10	0	-10	10	8	5	6	6	7	0	-250	-380	5
180	250	0	-12	0	-12	12	9	6	8	7	8	0	-300	-500	6

[Note]:

- 1) 0.6mm is included.
- 2) Only suitable for diameter series of P0, P1, P2, P3 and P4.
- 3) The values are not given for bearing diameter series 7 and 8.
- 4) Only suitable for deep groove bearings.
- 5) Suitable for inner ring of a single bearing in matched pair or stacking mount.

Rolling Bearings

Table 10: Tolerance of Class P4 outer ring μm

d mm	Δ d _{mp}		Δ d _s ²⁾		V _{dp} ³⁾⁴⁾		V _{D_{mp}}	K _{ea}	S _D ⁵⁾ S _{D1} ⁶⁾	S _{ea} ⁵⁾⁶⁾	S _{ea} ⁶⁾	Δ C _s ⁶⁾		V _{Bs}
					Diameter series							High	Low	
					9	0,1,2,3,4								
Over	To	High	Low	High	Low	max	max	max	max	max	max	High	Low	max
2.5 ¹⁾	6	0	-4	0	-4	4	3	2	3	4	5	7	Same as the ΔBs of the same bearing I.D.	2.5
6	18	0	-4	0	-4	4	3	2	3	4	5	7		2.5
18	30	0	-5	0	-5	5	4	2.5	4	4	5	7		2.5
30	30	0	-5	0	-5	5	4	2.5	4	4	5	7		2.5
50	50	0	-6	0	-6	6	5	3	5	4	5	7		3
80	80	0	-7	0	-7	7	5	3.5	5	4	5	7		4
120	120	0	-8	0	-8	8	6	4	6	5	6	8		5
150	150	0	-9	0	-9	9	7	5	7	5	7	10		5
180	180	0	-10	0	-10	10	8	5	8	5	8	11		7
250	180	0	-10	0	-10	10	8	5	8	5	8	11		7
315	250	0	-11	0	-11	11	8	6	10	7	10	14	7	
	315	0	-13		-13	13	10	7	11	8	10	14	7	
	400	0	-15		-15	15	11	8	13	10	13	18	8	

[Note]:

- 1) 2.5mm is included
- 2) Only suitable for diameter series of P0, P1, P2, P3 and P4
- 3) The values are not given for bearing diameter series 7 and 8
- 4) The values are not given for closed bearings
- 5) No suitable for bearings with flanged outer ring
- 6) Only applicable for deep groove bearings

Tolerance of P2 (Table 11, Table 12)

Table 11: Tolerance of Class P2 inner ring μm

d mm	Δ d _{mp}		Δ d _s		V _{dp} ²⁾	V _{D_{mp}}	K _{ia}	S _d	S _{ia} ³⁾	Δ B _s			V _{Bs}	
										All	Normal	Revision		
Over	To	High	Low	High	Low	max	max	max	max	max	All	Normal	Revision	max
0.6 ¹⁾	2.5	0	-2.5	0	-2.5	2.5	1.5	1.5	1.5	1.5	0	-40	-250	1.5
2.5	10	0	-2.5	0	-2.5	2.5	1.5	1.5	1.5	1.5	0	-40	-250	1.5
10	18	0	-2.5	0	-2.5	2.5	1.5	1.5	1.5	1.5	0	-80	-250	1.5
18	30	0	-2.5	0	-2.5	2.5	1.5	2.5	1.5	2.5	0	-120	-250	1.5
30	50	0	-2.5	0	-2.5	2.5	1.5	2.5	1.5	2.5	0	-120	-250	1.5
50	80	0	-4	0	-4	4	2	2.5	1.5	2.5	0	-150	-250	1.5
80	120	0	-5	0	-5	5	2.5	2.5	2.5	2.5	0	-200	-380	2.5
120	150	0	-7	0	-7	7	3.5	2.5	2.5	2.5	0	-250	-380	2.5
150	180	0	-7	0	-7	7	3.5	5	4	5	0	-250	-380	4
180	250	0	-8	0	-8	8	4	5	5	5	0	-300	-500	5

[Note]: 1) 0.6mm is included in this dimension range.

2) The values are not given for bearing diameter series 7, 8 and 9.

3) Only suitable for deep groove bearings.

4) Refers to inner ring width deviation of single bearings when matched or group installed.

Table 12: Tolerance of Class P2 outer ring μm

D mm	Δ D _{mp}		Δ D _s ²⁾		V _{dp} ²⁾	V _{D_{mp}}	K _{ea}	S _D ³⁾ S _{D1} ⁴⁾	S _{ea} ³⁾⁴⁾	S _{ea} ⁴⁾	Δ C _s ⁴⁾		V _{C_s} V _{C1s} ⁴⁾	
											High	Low		
Over	To	High	Low	High	Low	max	max	max	max	max	max	High	Low	max
2.5 ¹⁾	6	0	-2.5	0	-2.5	2.5	1.5	1.5	1.5	1.5	3	Same as the ΔBs of the same bearing I.D.	1.5	
6	18	0	-2.5	0	-2.5	2.5	1.5	1.5	1.5	3	1.5			
18	30	0	-4	0	-4	4	2	2.5	1.5	2.5	4		1.5	
30	50	0	-4	0	-4	4	2	2.5	1.5	2.5	4		1.5	
50	80	0	-4	0	-4	4	2	4	1.5	4	6		1.5	
80	120	0	-5	0	-5	5	2.5	5	2.5	5	7		2.5	
120	150	0	-5	0	-5	5	2.5	5	2.5	5	7		2.5	
150	180	0	-7	0	-7	7	3.5	5	2.5	5	7		2.5	
180	250	0	-8	0	-8	8	4	7	4	7	10		4	
250	315	0	-8	0	-8	8	4	7	5	7	10		5	
315	400	0	-10	0	-10	10	5	8	8	11	7	7		

[Note]: 1) 2.5mm is included.

2) Only suitable for open and closed bearings with diameter series of P0, P1, P2, P3 and P4.

3) Not suitable for bearings with flanged outer ring.

4) Only applicable for deep groove bearings.

Rolling Bearings

Precision of metric tapered roller bearings

Tolerance of P0 (Table 13, Table 14 and Table 15)

Table 13: Diameter tolerance and radial runout of inner ring μm

d mm		Δ d _{mp}		V _{dp}	V _{dmp}	K _{ia}
Over	To	High	Low	max	max	max
10	18	0	-12	12	9	15
18	30	0	-12	12	9	18
30	50	0	-12	12	9	20
50	80	0	-15	15	11	25
80	120	0	-20	20	15	30
120	180	0	-25	25	19	35
180	250	0	-30	30	23	50
250	315	0	-35	35	26	60
315	400	0	-40	40	30	70
400	500	0	-45	45	34	80
500	630	0	-60	60	40	90
630	800	0	-75	75	45	100
800	1000	0	-100	100	55	115
1000	1250	0	-125	125	65	130
1250	1600	0	-160	160	80	150
1600	2000	0	-200	200	100	170

Table 14: Diameter tolerance and radial runout of outer ring μm

D mm		Δ D _{mp}		V _{Dp}	V _{Dmp}	K _{ea}
Over	To	High	Low	max	max	max
18	30	0	-12	12	9	18
30	50	0	-14	14	11	20
50	80	0	-16	16	12	25
80	120	0	-18	18	14	35
120	150	0	-20	20	15	40
150	180	0	-25	25	19	45
180	250	0	-30	30	23	50
250	315	0	-35	35	26	60
315	400	0	-40	40	30	70
400	500	0	-45	45	34	80
500	630	0	-50	50	38	100
630	800	0	-75	80	55	120
800	1000	0	-100	100	75	140
1000	1250	0	-125	130	90	160
1250	1600	0	-160	170	100	180
1600	2000	0	-200	210	110	200
2000	2500	0	-250	265	120	220

Table 15: Width-Inner ring, outer ring, single-row bearing and its assembly μm

d mm		Δ B _s		Δ C _s		Δ T _s		Δ T _{1s}		Δ T _{2s}	
Over	To	High	Low	High	Low	High	Low	High	Low	High	Low
10	18	0	-120	0	-120	+200	0	+100	0	+100	0
18	30	0	-120	0	-120	+200	0	+100	0	+100	0
30	50	0	-120	0	-120	+200	0	+100	0	+100	0
50	80	0	-150	0	-150	+200	0	+100	0	+100	0
80	120	0	-200	0	-200	+200	-200	+100	-100	+100	-100
120	180	0	-250	0	-250	+350	-250	+150	-150	+200	-100
180	250	0	-300	0	-300	+350	-250	+150	-150	+200	-100
250	315	0	-350	0	-350	+350	-250	+150	-150	+200	-100
315	400	0	-400	0	-400	+400	-400	+200	-200	+200	-200
400	500	0	-450	0	-450	+450	-450	+225	-225	+225	-225
500	630	0	-500	0	-500	+500	-500	-	-	-	-
630	800	0	-750	0	-750	+600	-600	-	-	-	-
800	1000	0	-1000	0	-1000	+750	-750	-	-	-	-
1000	1250	0	-1250	0	-1250	+900	-900	-	-	-	-
1250	1600	0	-1600	0	-1600	+1050	-1050	-	-	-	-
1600	2000	0	-2000	0	-2000	+1200	-1200	-	-	-	-

Tolerance of P6X

The tolerance of diameter and radial runout of inner ring and outer ring diameter of this tolerance class are the same with those given for Class P0. Width tolerance values are listed in Table 16.

Table 16: Width-Inner ring, outer ring, single-row bearing and its assembly μm

d mm		Δ B _s		Δ C _s		Δ T _s		Δ T _{1s}		Δ T _{2s}	
Over	To	High	Low	High	Low	High	Low	High	Low	High	Low
10	18	0	-50	0	-100	+100	0	+50	0	+50	0
18	30	0	-50	0	-100	+100	0	+50	0	+50	0
30	50	0	-50	0	-100	+100	0	+50	0	+50	0
50	80	0	-50	0	-100	+100	0	+50	0	+50	0
80	120	0	-50	0	-100	+100	0	+50	0	+50	0
120	180	0	-50	0	-100	+150	0	+50	0	+100	0
180	250	0	-50	0	-100	+150	0	+50	0	+100	0
250	315	0	-50	0	-100	+200	0	+100	0	+100	0
315	400	0	-50	0	-100	+200	0	+100	0	+100	0
400	500	0	-50	0	-100	+200	0	+100	0	+100	0

Rolling Bearings

Tolerance of P5 (Table 17, Table 18)

Table 17: Inner ring and single row bearing width

µm

d mm		Δ dmp		V _{dp}	V _{dmp}	K _{ia}	S _d	Δ B _s		Δ T _s	
Over	To	High	Low	max	max	max	max	High	Low	High	Low
10	18	0	-7	5	5	5	7	0	-200	+200	-200
18	30	0	-8	6	5	5	8	0	-200	+200	-200
30	50	0	-10	8	5	6	8	0	-240	+200	-200
50	80	0	-12	9	6	7	8	0	-300	+200	-200
80	120	0	-15	11	8	8	9	0	-400	+200	-200
120	180	0	-18	14	9	11	10	0	-500	+350	-250
180	250	0	-22	17	11	13	11	0	-600	+350	-250
250	315	0	-25	19	13	13	13	0	-700	+350	-250
315	400	0	-30	23	15	15	15	0	-800	+400	-400
400	500	0	-35	28	17	20	17	0	-900	+450	-450
500	630	0	-40	35	20	25	20	0	-1100	+500	-500
630	800	0	-50	45	25	30	25	0	-1600	+600	-600
800	1000	0	-60	60	30	37	30	0	-2000	+750	-750
1000	1250	0	-75	75	37	45	40	0	-2000	+750	-750
1250	1600	0	-90	90	45	55	50	0	-2000	+900	-900

Tolerance of P4 (Table 19, Table 20)

Table 19: Inner ring and single row bearing width

µm

d mm		Δ dmp		Δ d _s		V _{dp}	V _{dmp}	K _{ia}	S _d	S _{ia}	Δ B _s		Δ T _s	
Over	To	High	Low	High	Low	max	max	max	max	max	High	Low	High	Low
10	18	0	-5	0	-5	4	4	3	3	3	0	-200	+200	-200
18	30	0	-6	0	-6	5	4	3	4	4	0	-200	+200	-200
30	50	0	-8	0	-8	6	5	4	4	4	0	-240	+200	-200
50	80	0	-9	0	-9	7	5	4	5	4	0	-300	+200	-200
80	120	0	-10	0	-10	8	5	5	5	5	0	-400	+200	-200
120	180	0	-13	0	-13	10	7	6	6	7	0	-500	+350	-250
180	250	0	-15	0	-15	11	8	8	7	8	0	-600	+350	-250
250	315	0	-18	0	-18	12	9	9	8	9	0	-700	+350	-250

Table 18: Outer ring

µm

D mm		Δ D _{mp}		V _{Dp}	V _{dmp}	K _{ea}	S _D ¹⁾ S _{D1}	Δ c _s	
Over	To	High	Low	max	max	max	max	High	Low
18	30	0	-8	6	5	6	8	Same as the ΔBs of the same bearing I.D.	
30	50	0	-9	7	5	7	8		
50	80	0	-11	8	6	8	8		
80	120	0	-13	10	7	10	9		
120	150	0	-15	11	8	11	10		
150	180	0	-18	14	9	13	10		
180	250	0	-20	15	10	15	11		
250	315	0	-25	19	13	18	13		
315	400	0	-28	22	14	20	13		
400	500	0	-33	26	17	24	17		
500	630	0	-38	30	20	30	20		
630	800	0	-45	38	25	36	25		
800	1000	0	-60	50	30	43	30		
1000	1250	0	-80	65	38	52	38		
1250	1600	0	-100	90	50	62	50		
1600	2000	0	-125	120	65	73	65		

Table 20: Outer ring

µm

D mm		Δ D _{mp}		Δ D _s		V _{Dp}	V _{dmp}	K _{ea}	S _D ¹⁾ S _{D1}	S _{ea} ¹⁾	S _{seal}	Δ C _s	
Over	To	High	Low	High	Low	max	max	max	max	max	max	High	Low
18	30	0	-6	0	-6	5	4	4	4	5	7	Same as the ΔBs of the same bearing I.D.	
30	50	0	-7	0	-7	5	5	5	4	5	7		
50	80	0	-9	0	-9	7	5	5	4	5	7		
80	120	0	-10	0	-10	8	5	6	5	6	8		
120	150	0	-11	0	-11	8	6	7	5	7	10		
150	180	0	-13	0	-13	10	7	8	5	8	11		
180	250	0	-15	0	-15	11	8	10	7	10	14		
250	315	0	-18	0	-18	14	9	11	8	10	14		
315	400	0	-20	0	-20	15	10	13	10	13	18		

1) Not suitable for bearings with flanged outer ring.

1) Not suitable for bearings with flanged outer ring

Rolling Bearings

Tolerance of P2 (Table 21, Table 22)

Table 21 Inner ring and single row bearing width μm

d mm		Δ dmp		Δ ds		Vdp	Vdmp	Kia	Sd	Sia	Δ Bs		Δ Ts	
Over	To	High	Low	High	Low	max	max	max	max	max	High	Low	High	Low
10	18	0	-4	0	-4	2.5	1.5	2	1.5	2	0	-200	+200	-200
18	30	0	-4	0	-4	2.5	1.5	2.5	1.5	2.5	0	-200	+200	-200
30	50	0	-5	0	-5	3	2	2.5	2	2.5	0	-240	+200	-200
50	80	0	-5	0	-5	4	2	3	2	3	0	-300	+200	-200
80	120	0	-6	0	-6	5	2.5	3	2.5	3	0	-400	+200	-200
120	180	0	-7	0	-7	7	3.5	4	3.5	4	0	-500	+200	-250
180	250	0	-8	0	-8	7	4	5	5	5	0	-600	+200	-300
250	315	0	-8	0	-8	8	5	6	5.5	6	0	-700	+200	-300

Table 22: Outer ring μm

D mm		Δ Dmp		Δ Ds		VDP	VDmp	Kea	SD ¹⁾ SD1	Sea	Seal ¹⁾	Δ Cs	
Over	To	High	Low	High	Low	max	max	max	max	max	max	High	Low
18	30	0	-5	0	-5	4	2.5	2.5	1.5	2.5	4	Same as the ΔBs of the same bearing I.D.	
30	50	0	-5	0	-5	4	2.5	2.5	2	2.5	4		
50	80	0	-6	0	-6	4	2.5	4	2.5	4	6		
80	120	0	-6	0	-6	5	3	5	3	5	7		
120	150	0	-7	0	-7	5	3.5	5	3.5	5	7		
150	180	0	-7	0	-7	7	4	5	4	5	7		
180	250	0	-8	0	-8	8	5	7	5	7	10		
250	315	0	-9	0	-9	8	5	7	6	7	10		
315	400	0	-10	0	-10	10	6	8	7	8	11		

1) Not suitable for bearings with flanged outer ring

Outer ring flange of radial bearings

Radial ball bearing & Tapered roller bearing in different Tolerance grade

Table 23: Flanged outer ring tolerance μm

D1 mm		D1s			
		Mounting flange		Non-mounting flange	
Over	To	High	Low	High	Low
-	10	0	-36	+220	-36
10	18	0	-43	+270	-43
18	30	0	-52	+330	-52
30	50	0	-62	+390	-62
50	80	0	-74	+460	-74
80	120	0	-87	+540	-87
120	180	0	-100	+630	-100
180	250	0	-115	+720	-115
250	315	0	-130	+810	-130
315	400	0	-140	+890	-140
400	500	0	-155	+970	-155
500	630	0	-175	+1100	-175
630	800	0	-200	+1250	-200
800	1000	0	-230	+1400	-230
1000	1250	0	-260	+1650	-260
1250	1600	0	-310	+1950	-310
1600	2000	0	-370	+2300	-370
2000	2500	0	-440	+2800	-440

Tapered bore, taper of 1:12 and 1:30 (Figure 3 and Figure 4)

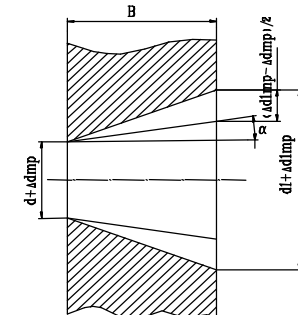
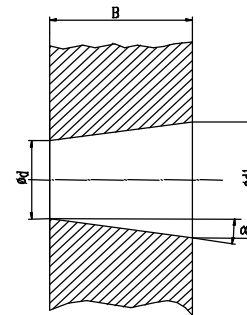

Figure 3: Theoretical tapered bore Figure 4: Tapered bore with actual mean diameter and its deviation

Rolling Bearings

Taper 1:12:

Nominal half taper angle $\alpha = 2^\circ 23' 9.4'' = 2.38594^\circ = 0.041643$ radian

Basic diameter of theoretical large end of tapered bore $d_1 = d + \frac{1}{12} B$

Taper 1:30:

Nominal half taper angle $\alpha = 0^\circ 57' 17.4'' = 0.95484^\circ = 0.01667$ radian $d_1 = d + \frac{1}{30} B$

Basic diameter of theoretical large end of tapered bore

The tolerance of tapered bore includes:

—Mean diameter tolerance indicated by limit value of actual mean diameter deviation Δd_{mp} of theoretical small end of tapered bore.

—Tapered tolerance indicated by limit value of the difference of actual mean diameter deviation of two ends of tapered bore.

—Diameter variation tolerance indicated by maximum value of inner diameter variation V_{dp} on any radial plain of tapered bore.

Tolerance of P0 (Table 24, Table 25)

Table 24: Tapered bore (1:12) μm

D ₁ mm		Δd _{mp}		Δd _{1mp} -Δd _{mp}		V _{dp} ¹⁾²⁾
Over	To	High	Low	High	Low	max
10	10	+22	0	+15	0	9
18	18	+27	0	+18	0	11
30	30	+33	0	+21	0	13
50	50	+39	0	+25	0	16
80	80	+46	0	+30	0	19
120	120	+54	0	+35	0	22
180	180	+63	0	+40	0	40
250	250	+72	0	+46	0	46
315	315	+81	0	+52	0	52
400	400	+89	0	+57	0	57
500	500	+97	0	+63	0	63
630	630	+110	0	+70	0	70
800	800	+125	0	+80	0	-
1000	1000	+140	0	+90	0	-
1250	1250	+165	0	+105	0	-
1600	1600	+195	0	+125	0	-

[Note]: 1) Suitable for any single radial plane of bore.

2) Not suitable for diameter series 7 and 8.

Table 25: Tapered bore (1:30) μm

D ₁ mm		Δd _{mp}		Δd _{1mp} -Δd _{mp}		V _{dp} ¹⁾²⁾
Over	To	High	Low	High	Low	max
50	80	+15	0	+30	0	19
80	120	+20	0	+35	0	22
120	180	+25	0	+40	0	40
180	250	+30	0	+46	0	46
250	315	+35	0	+52	0	52
315	400	+40	0	+57	0	57
400	500	+45	0	+63	0	63
500	630	+50	0	+70	0	70

[Note]: 1) Suitable for any single radial plain of bore.

2) Not suitable for diameter series 7 and 8.

Tolerance values of inch tapered roller bearings are listed in from Table 26 to Table 28

Table 26: I.D. tolerance of bearing cone μm

d mm		Δ d _s							
		CL4, 2		CL3		CL0		CL00	
Over	To	High	Low	High	Low	High	Low	High	Low
-	76.200	+13	0	+13	0	+13	0	+8	0
76.200	101.600	+25	0	+13	0	+13	0	+8	0
101.600	266.700	+25	0	+13	0	+13	0	+8	0
266.700	304.800	+25	0	+13	0	+13	0	-	-
304.800	609.600	+51	0	+25	0	+25	0	-	-

Table 27: Bearing O.D. tolerance and radial runout of cone and cup μm

D mm		Δ D _s						K _{ia} , K _{ea} , S _{ia} , S _{ea}				
		CL4, 2		CL3, 0		CL0		CL4	CL2	CL3	CL0	CL00
Over	To	High	Low	High	Low	High	Low	max	max	max	max	max
-	266.700	+25	0	+13	0	+8	0	51	38	8	4	2
266.700	304.800	+25	0	+13	0	-	-	51	38	8	4	-
304.800	609.600	+51	0	+25	0	-	-	51	38	18	-	-

Table 28: Bearing's width tolerance μm

d mm		Δ Ts					
		CL4, CL2		CL3, CL0		CL00	
Over	To	High	Low	High	Low	High	Low
-	101.600	+203	0	+203	-203	+203	-203
101.60	266.700	+356	-254	+203	-203	+203	-203
266.700	304.800	+356	-254	+203	-203	+203	-203
304.800	609.600	+381	-381	+203	-203	+203	-203

Tolerances of thrust bearings are listed in from Table 29 to Table 36

Table 29: Tolerance of P0 Shaft washer and bearing height μm

d and d2/mm		Δd _{mp} , Δd _{mp}		V _{dP} V _{d2p}	S _i	ΔTs		ΔT _{1s}	
Over	To	High	Low	max	max	High	Low	High	Low
—	18	0	-8	6	10	+20	-250	+150	-400
18	30	0	-10	8	10	+20	-250	+150	-400
30	50	0	-12	9	10	+20	-250	+150	-400
50	80	0	-15	11	10	+20	-300	+150	-500
80	120	0	-20	15	15	+25	-300	+200	-500
120	180	0	-25	19	15	+25	-400	+200	-600
180	250	0	-30	23	20	+30	-400	+250	-600
250	315	0	-35	26	25	+40	-400		
315	400	0	-40	30	30	+40	-500		
400	500	0	-45	34	30	+50	-500		
500	630	0	-50	38	35	+60	-600		
630	800	0	-75	55	40	+70	-750		
800	1000	0	-100	75	45	+80	-1000		
1000	1250	0	-125	95	50	+100	-1400		
1250	1600	0	-160	120	60	+120	-1600		
1600	2000	0	-200	150	75	+140	-1900		
2000	2500	0	-250	190	90	+160	-2300		

Tolerance of thrust bearings

Symbols

d: nominal bore diameter of single direction bearing shaft washer

d2: nominal bore diameter of double direction bearing shaft washer

Δ_{dmp}: Single radial plane mean bore diameter deviation of single direction bearing shaft washer

Δ_{d2mp}: Single radial plane mean bore diameter deviation of double direction bearing shaft washer

V_{dp}: Single radial plane mean bore diameter variation of single direction bearing shaft washer

V_{d2p}: Single radial plane mean bore diameter variation of double direction bearing shaft washer

D: nominal outer diameter of housing washer

Δ_{Dmp}: Single radial plane mean outer diameter deviation of housing washer

Δ_{Dp}: Single radial plane mean outer diameter variation of housing washer

S_i: Variation of raceway thickness of shaft washer or central shaft washer

Remarks: only suitable for thrust ball bearing and thrust cylindrical roller bearing with contact angle of 90°

S_e: Variation of raceway thickness of housing washer

Remarks: only suitable for thrust ball bearing and thrust cylindrical roller bearing with contact angle of 90°

T: Nominal height of single direction bearing

T₁: Nominal height of double direction bearing

Δ_{Ts}: Actual height deviation of single direction bearing

Δ_{T1s}: Actual height deviation of double direction bearing

[Note]: For double direction bearings, the tolerances are only suitable for bearings which d2 ≤ 190mm.

Table 30: Tolerance of P0 housing washer μm

D/mm		ΔD _{mp}		V _{Dp}	S _e
Over	To	High	Low	max	max
10	18	0	-11	8	Same as shaft washer's Si value of the same bearing
18	30	0	-13	10	
30	50	0	-16	12	
50	80	0	-19	14	
80	120	0	-22	17	
120	180	0	-25	19	
180	250	0	-30	23	
250	315	0	-35	26	
315	400	0	-40	30	
400	500	0	-45	34	
500	630	0	-50	38	
630	800	0	-75	55	
800	1000	0	-100	75	
1000	1250	0	-125	95	
1250	1600	0	-160	120	
1600	2000	0	-200	150	
2000	2500	0	-250	190	
2500	2850	0	-300	225	

[Note]: For double direction bearings, the tolerances are only suitable for bearings which $D \leq 360\text{mm}$.

Table 31: Tolerance of P6 Shaft washer and bearing height μm

d and d2/mm		Δd _{mp} , Δd _{mp}		V _{dP} V _{d2p}	S _i	ΔT _s		ΔT _{1s}	
Over	To	High	Low	max	max	High	Low	High	Low
—	18	0	-8	6	10	+20	-250	+150	-400
18	30	0	-10	8	10	+20	-250	+150	-400
30	50	0	-12	9	10	+20	-250	+150	-400
50	80	0	-15	11	10	+20	-300	+150	-500
80	120	0	-20	15	15	+25	-300	+200	-500
120	180	0	-25	19	15	+25	-400	+200	-600
180	250	0	-30	23	20	+30	-400	+250	-600
250	315	0	-35	26	25	+40	-400		
315	400	0	-40	30	30	+40	-500		
400	500	0	-45	34	30	+50	-500		
500	630	0	-50	38	35	+60	-600		
630	800	0	-75	55	40	+70	-750		
800	1000	0	-100	75	45	+80	-1000		
1000	1250	0	-125	95	50	+100	-1400		
1250	1600	0	-160	120	60	+120	-1600		
1600	2000	0	-200	150	75	+140	-1900		
2000	2500	0	-250	190	90	+160	-2300		

[Note]: For double direction bearings, the tolerances are only suitable for bearings which $d2 \leq 190\text{mm}$.

Table 32: Tolerance of P6 housing washer μm

D/mm		ΔD _{mp}		V _{Dp}	S _e
Over	To	High	Low	max	max
10	18	0	-11	8	Same as shaft washer's Si value of the same bearing
18	30	0	-13	10	
30	50	0	-16	12	
50	80	0	-19	14	
80	120	0	-22	17	
120	180	0	-25	19	
180	250	0	-30	23	
250	315	0	-35	26	
315	400	0	-40	30	
400	500	0	-45	34	
500	630	0	-50	38	
630	800	0	-75	55	
800	1000	0	-100	75	
1000	1250	0	-125	95	
1250	1600	0	-160	120	
1600	2000	0	-200	150	
2000	2500	0	-250	190	
2500	2850	0	-300	225	

[Note]: For double direction bearings, the tolerances are only suitable for bearings which D ≤ 360mm.

Table 33: Tolerance of P5 Shaft washer and bearing height μm

d and d2/mm		Δd _{mp} , Δd _{mp}		V _{dP} V _{d2p}	S _i	ΔT _s		ΔT _{1s}	
Over	To	High	Low	max	max	High	Low	High	Low
—	18	0	-8	6	10	+20	-250	+150	-400
18	30	0	-10	8	10	+20	-250	+150	-400
30	50	0	-12	9	10	+20	-250	+150	-400
50	80	0	-15	11	10	+20	-300	+150	-500
80	120	0	-20	15	15	+25	-300	+200	-500
120	180	0	-25	19	15	+25	-400	+200	-600
180	250	0	-30	23	20	+30	-400	+250	-600
250	315	0	-35	26	25	+40	-400		
315	400	0	-40	30	30	+40	-500		
400	500	0	-45	34	30	+50	-500		
500	630	0	-50	38	35	+60	-600		
630	800	0	-75	55	40	+70	-750		
800	1000	0	-100	75	45	+80	-1000		
1000	1250	0	-125	95	50	+100	-1400		
1250	1600	0	-160	120	60	+120	-1600		
1600	2000	0	-200	150	75	+140	-1900		
2000	2500	0	-250	190	90	+160	-2300		

[Note]: For double direction bearings, the tolerances are only suitable for bearings which d2 ≤ 190mm.

Table 34: Tolerance of P5 housing washer μm

D/mm		ΔD _{mp}		V _{Dp}	S _e
Over	To	High	Low	max	max
10	18	0	-11	8	Same as shaft washer's Si value of the same bearing
18	30	0	-13	10	
30	50	0	-16	12	
50	80	0	-19	14	
80	120	0	-22	17	
120	180	0	-25	19	
180	250	0	-30	23	
250	315	0	-35	26	
315	400	0	-40	30	
400	500	0	-45	34	
500	630	0	-50	38	
630	800	0	-75	55	
800	1000	0	-100	75	
1000	1250	0	-125	95	
1250	1600	0	-160	120	
1600	2000	0	-200	150	
2000	2500	0	-250	190	
2500	2850	0	-300	225	

[Note]: For double direction bearings, the tolerances are only suitable for bearings which $D \leq 360\text{mm}$.

Table 35: Tolerance of P4 shaft washer and bearing height μm

d and d2/mm		Δd _{mp} , Δd _{mp}		V _{dP} V _{d2p}	S _i	ΔT _s		ΔT _{1s}	
Over	To	High	Low	max	max	High	Low	High	Low
—	18	0	-7	5	2	+20	-250	+150	-400
18	30	0	-8	6	2	+20	-250	+150	-400
30	50	0	-10	8	2	+20	-250	+150	-400
50	80	0	-12	9	3	+20	-300	+150	-500
80	120	0	-15	11	3	+25	-300	+200	-500
120	180	0	-18	14	4	+25	-400	+200	-600
180	250	0	-22	17	4	+30	-400	+250	-600
250	315	0	-25	19	5	+40	-400		
315	400	0	-30	23	5	+40	-500		
400	500	0	-35	26	6	+50	-500		
500	630	0	-40	30	7	+60	-600		
630	800	0	-50	40	8	+70	-750		

[Note]: For double direction bearings, the tolerances are only suitable for bearings which $d2 \leq 190\text{mm}$.

Rolling Bearings

Table 36: Tolerance P4 Housing washer

μm

D/mm		ΔD _{mp}		V _{Dp}	S _e
Over	To	High	Low	max	max
10	18	0	-7	5	Same as shaft washer's Si value of the same bearing
18	30	0	-8	6	
30	50	0	-9	7	
50	80	0	-11	8	
80	120	0	-13	10	
120	180	0	-15	11	
180	250	0	-20	15	
250	315	0	-25	19	
315	400	0	-28	21	
400	500	0	-33	25	
500	630	0	-38	29	
630	800	0	-45	34	
800	1000	0	-60	45	

[Note]: For double direction bearings, the tolerances are only suitable for bearings which $D \leq 360\text{mm}$.

Limit Dimension of Chamfer

(1) Radial bearings (except tapered roller bearings)

Unit: mm

r (min.) or r ₁ (min.)	Nominal bore diameter of the bearing d mm		Radial	Axial
			r (min.) or r ₁ (min.)	
	Over	To		
0.05	-	-	0.1	0.2
0.08	-	-	0.16	0.3
0.1	-	-	0.2	0.4
0.15	-	-	0.3	0.6
0.2	-	-	0.5	0.8
0.3	-	40	0.6	1
	40	-	0.8	1
0.6	-	40	1	2
	40	-	1.3	2
1	-	50	1.5	3
	50	-	1.9	3
1.1	-	120	2	3.5
	120	-	2.5	4
1.5	-	120	2.3	4
	120	-	3	5
2	-	80	3	4.5
	80	220	3.5	5
	220	-	3.8	6
0.3	-	280	4	6.5
	280	-	4.5	7
0.3	-	100	3.8	6
	100	280	4.5	6
	280	-	5	7
0.3	-	280	5	8
	280	-	5.5	8
4	-	-	6.5	9
5	-	-	8	10
6	-	-	10	13
7.5	-	-	12.5	17
9.5	-	-	15	19
12	-	-	18	24
15	-	-	21	30
19	-	-	25	38

(2) Metric tapered roller bearing

Unit: mm

r (min.) or r ₁ (min.)	Bearing nominal bore diameter d or outer diameter D mm		Radial	Axial
			r (min.) or r ₁ (min.)	
	Over	To		
0.3	-	40	0.7	1.4
	40	-	0.9	1.6
0.6	-	40	1.1	1.7
	40	-	1.3	2
1	-	50	1.6	2.5
	50	-	1.9	3
1.5	-	120	2.3	3
	120	250	2.8	3.5
	250	-	3.5	4
2	-	120	2.8	4
	120	250	3.	4.5
	250	-	4	5
2.5	-	120	3.5	5
	120	250	4	5.5
	250	-	4.5	6
3	-	120	4	5.5
	120	250	4.5	6.5
	250	400	5	7
	400	-	5.5	7.5
4	-	120	5	7
	120	250	5.5	7.5
	250	400	6	8
	400	-	6.5	8.5
5	-	180	6.5	8
	180	-	7.5	9
6	-	180	7.5	10
	180	-	9	11

Rolling Bearings

(3) Thrust bearing Unit: mm Basic tolerance Unit: mm

r (min.) or r1 (min.)	Radial and Axial r (min.) or r1 (min.)	Basic dimension mm Over To		Basic tolerance class IT										
		IT1	IT2	IT3	IT4	IT5	IT6	IT7	IT8	IT9	IT10			
0.05	0.1	-	3	0.8	1.2	2	3	4	6	10	14	25	40	
0.08	0.16	3	6	1	1.5	2.5	4	5	8	12	18	30	48	
0.1	0.2	6	10	1	1.5	2.5	4	6	9	15	22	36	58	
0.15	0.3	10	18	1.2	2	3	5	8	11	18	27	43	70	
0.2	0.5	18	30	1.5	2.5	4	6	9	13	21	33	52	84	
0.3	0.8	30	50	1.5	2.5	4	7	11	16	25	39	62	100	
0.6	1.5	50	80	2	3	5	8	13	19	30	46	74	120	
1	2.2	80	120	2.5	4	6	10	15	22	35	54	87	140	
1.1	2.7	120	180	3.5	5	8	12	18	25	40	63	100	160	
1.5	3.5	180	250	4.5	7	10	14	20	29	46	72	115	185	
2	4	250	315	6	8	12	16	23	32	52	81	130	210	
2.1	4.5	315	400	7	9	13	18	25	36	57	89	140	230	
3	5.5	40	500	8	10	15	20	27	40	63	97	155	250	
4	6.5	500	630	9	11	16	22	30	44	70	110	175	280	
5	8	630	800	10	13	18	25	35	50	80	125	200	320	
6	10	800	1000	11	15	21	29	40	56	90	140	230	360	
7.5	12.5	1000	1250	13	18	24	34	46	66	105	165	260	420	
9.5	15	1250	1600	15	21	29	40	54	78	125	195	310	500	
12	18	1600	2000	18	25	35	48	65	92	150	230	370	600	
15	21	2000	2500	22	30	41	57	77	110	175	280	440	700	
19	25	2500	3150	26	36	50	69	93	135	210	330	540	860	

Bearing Clearance

The bearing clearance, means before mounting the bearing to the shaft or housing, fix the inner ring or the outer ring and move the other unfixed ring in the radial or axial direction, the amount of movement is called the bearing clearance. According to the moving direction, it can be divided into radial clearance and axial clearance.

The amount of clearance while the bearing is rotating (the so-called working clearance) shall have effects on the rolling fatigue life, temperature rise, noise, vibration and other functions.

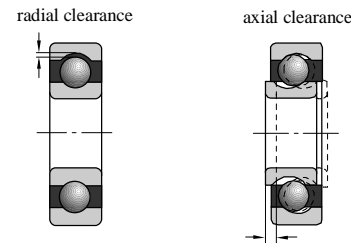

Figure 1: The clearance of the bearing

When measuring the clearance of bearing, in order to get the stable value of the clearance, normally a stated measuring load is put on the bearing. Therefore, the measured value is larger than the true clearance (called the theoretical clearance), which means the amount of the elastic deformation caused by the load increased. But for the rolling bearings, this elastic deformation can be ignored since it is comparatively small. Before the mounting, the internal clearance is normally expressed with the theoretical clearance.

The selection of the clearance

It is very important to choose bearing clearance and also an important factor for normal operation. Choosing proper bearing clearance

can make loads distributed reasonably among the bearing rolling elements, limit the axial and radial displacement of axle (or housing), make sure of bearing rotating precision, work normally in the specified temperature, reduce vibration and noise and improve bearing service life.

If the amount of expansion or contraction of the rings caused by the interference fit when mounting the bearing on the shaft or in the housing is deducted from the theoretical clearance, then we have the "Mounting Clearance". Furthermore, if the dimensional changed caused by the temperature difference inside the bearing is added to or reduced from the mounting clearance, we have the so-called "Effective Clearance". When the bearing rotates while carrying a certain magnitude of load in the machine, if the elastic deformation caused by the load is added to the effective clearance, then we have the "Working Clearance". As shown in Figure 2, when the working clearance is a slightly negative, the bearing has the longest service life. But with the negative clearance changing to be positive, the fatigue life shall decrease. Therefore, when choosing the clearance, it is preferred to choose the 0 or slightly positive working clearance.

Figure 2 Relation between the working clearance and the fatigue life.

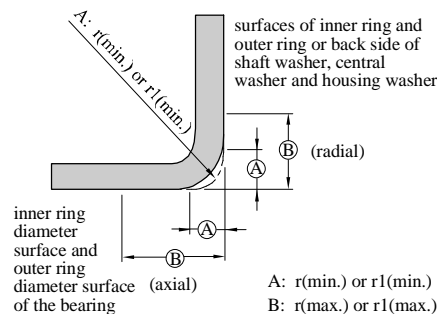
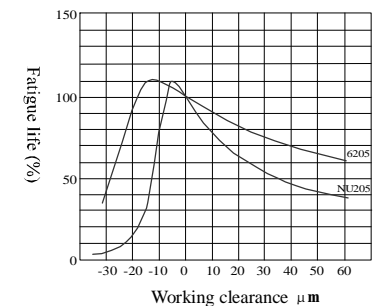

Rolling Bearings

When choosing bearing clearance, pay attention to these aspects as below:

1. Working condition of bearing, such as loads, temperature, rotation speed, etc.

2. Requirements for bearing operation performance (rotating precision, friction torque, vibration, noise);

3. Reduction of bearing clearance caused by interference fit of bearing, axle and housing;

4. When bearing is running, temperature differences of inner and outer ring cause bearing clearance reducing.

5. Different expansion coefficients of the axle and housing cause increasing or decreasing of bearing clearance. According to operation experience, the most suitable working clearance of ball bearing is close to zero and for roller bearing, a bit of clearance should be kept. In the parts with good supporting rigidity as required, bearing is allowed to have pretension force of a certain value. Under normal working condition, it should firstly use basic group that can make bearing with proper working clearance. When the basic group can not meet usage requirement, auxiliary group clearance should be chosen. Auxiliary group of large clearance is suitable for when bearing, axle and housing adopting interference fit. Auxiliary group of small clearance is fit for occasions that high rotating precision is required, axial displacement of housing hole is strictly controlled and vibration and noise need to be reduced. In addition, when it need to improve bearing rigidity or reduce noise, the working clearance should adopt further negative value and when the bearing temperature rises rapidly, the working clearance need adopt further positive value, which should make a concrete analysis according to the usage condition.

The values of bearing clearances are shown in Tale 1 to Table 9.

Table 1 Radial clearance of deep groove ball bearings (cylindrical bore) μm

Nominal bore diameter d mm		Clearance									
		Group 2		Group 0		Group 3		Group 4		Group 5	
Over	To	min.	max.	min.	max.	min.	max.	min.	max.	min.	max.
2.5	6	0	7	2	13	8	23	-	-	-	-
6	10	0	7	2	13	8	23	14	29	20	37
10	18	0	9	3	18	11	25	18	33	25	45
18	24	0	10	5	20	13	28	20	36	28	48
24	30	1	11	5	20	13	28	23	41	30	53
30	40	1	11	6	20	15	33	28	46	40	64
40	50	1	11	6	23	18	36	30	51	45	73
50	65	1	15	8	28	23	43	38	61	55	90
65	80	1	15	10	30	25	51	46	71	65	105
80	100	1	18	12	36	30	58	53	84	75	120
100	120	2	20	15	41	36	66	61	97	90	140
120	140	2	23	18	48	41	81	71	114	105	160
140	160	2	23	18	53	46	91	81	130	120	180
160	180	2	25	20	61	53	102	91	147	135	200
180	200	2	30	25	71	63	117	107	163	150	230
200	225	2	35	25	85	75	140	125	195	175	265
225	250	2	40	30	95	85	160	145	225	205	300
250	280	2	45	35	105	90	170	155	245	225	340
280	315	2	55	40	115	100	190	175	270	245	370
315	355	3	60	45	125	110	210	195	300	275	410
355	400	3	70	55	145	130	240	225	340	315	460
400	450	3	80	60	170	150	270	250	380	350	510
450	500	3	90	70	190	170	300	280	420	390	570
500	560	10	100	80	210	190	330	310	470	440	630
560	630	10	110	90	230	210	360	340	520	490	690
630	710	20	130	110	260	240	400	380	570	540	760
710	800	20	140	120	290	270	450	430	630	600	840
800	900	20	160	140	320	300	500	480	700	670	940
900	1000	20	170	150	350	330	550	530	770	740	1040
1000	1120	20	180	160	380	360	600	580	850	820	1150
1120	1250	20	190	170	410	390	650	630	920	890	1260

Rolling Bearings

Table 2 Radial clearance of self-aligning ball bearings

(1) Radial clearance of self-aligning ball bearings with cylindrical bore μm

Nominal bore diameter d mm		Clearance									
		Group 2		Group 0		Group 3		Group 4		Group 5	
Over	To	min.	max.	min.	max.	min.	max.	min.	max.	min.	max.
2.5	6	1	8	5	15	10	20	15	25	21	33
6	10	2	9	6	17	12	25	19	33	27	42
10	14	2	10	6	19	13	26	21	35	30	48
14	18	3	12	8	21	15	28	23	37	32	50
18	24	4	14	10	23	17	30	25	39	34	52
24	30	5	16	11	24	19	35	29	46	40	58
30	40	6	18	13	29	23	40	34	53	46	66
40	50	6	19	14	31	25	44	37	57	50	71
50	65	7	21	16	36	30	50	45	69	62	88
65	80	8	24	18	40	35	60	54	83	76	108
80	100	9	27	22	48	42	70	64	96	89	124
100	120	10	31	25	56	50	83	75	114	105	145
120	140	10	38	30	68	60	100	90	135	125	175
140	160	15	44	35	80	70	120	110	161	150	210

(2) Radial clearance of self-aligning ball bearing with tapered bore μm

Nominal bore diameter d mm		Clearance									
		Group 2		Group 0		Group 3		Group 4		Group 5	
Over	To	min.	max.	min.	max.	min.	max.	min.	max.	min.	max.
18	24	7	17	13	26	20	33	28	42	37	55
24	30	9	20	15	28	23	39	33	50	44	62
30	40	12	24	19	35	29	46	40	59	52	72
40	50	14	27	22	39	33	52	45	65	58	79
50	65	18	32	27	47	41	61	56	80	73	99
65	80	23	39	35	57	50	75	69	98	91	123
80	100	29	47	42	68	62	90	84	116	109	144
100	120	35	56	50	81	75	108	100	139	130	170
120	140	40	68	60	98	90	130	120	165	155	205
140	160	45	74	65	110	100	150	140	191	180	240

Table 3 Radial clearance of cylindrical rolling bearing with cylindrical bore μm

Nominal bore diameter d mm		Clearance									
		Group 2		Group 0		Group 3		Group 4		Group 5	
Over	To	min.	max.	min.	max.	min.	max.	min.	max.	min.	max.
10	10	0	25	20	45	35	60	50	75	-	-
10	24	0	25	20	45	35	60	50	75	65	90
24	30	0	25	20	45	35	60	50	75	70	95
30	40	5	30	25	50	45	70	60	85	80	105
40	50	5	35	30	60	50	80	70	100	95	125
50	65	10	40	40	70	60	90	80	110	110	140
65	80	10	45	40	75	65	100	90	125	130	165
80	100	15	50	50	85	75	110	105	140	155	190
100	120	15	55	50	90	85	125	125	165	180	220
120	140	15	60	60	105	100	145	145	190	200	245
140	160	20	70	70	120	115	165	165	215	225	275
160	180	25	75	75	125	120	170	170	220	250	300
180	200	35	90	90	145	140	195	195	250	275	330
200	225	45	105	105	165	160	220	220	280	305	365
225	250	45	110	110	175	170	235	235	300	330	395
250	280	55	125	125	195	190	260	260	330	370	440
280	315	55	130	130	205	200	275	275	350	410	485
315	355	65	145	145	225	225	305	305	385	455	535
355	400	100	190	190	280	280	370	370	460	510	600
400	450	110	210	210	310	310	410	410	510	565	665
450	500	110	220	220	330	330	440	440	550	625	735

Rolling Bearings

Table 4: Radial clearance of Self-aligning rolling bearings

(1) Self-aligning rolling bearings with cylindrical bore μm

Nominal bore diameter d mm		Clearance									
		Group 2		Group 0		Group 3		Group 4		Group 5	
Over	To	min.	max.	min.	max.	min.	max.	min.	max.	min.	max.
14	18	10	20	20	35	35	45	45	60	60	75
18	24	10	20	20	35	35	45	45	60	60	75
24	30	15	25	25	40	40	55	55	75	75	95
30	40	15	30	30	45	45	60	60	80	80	100
40	50	20	35	35	55	55	75	75	100	100	125
50	65	20	40	40	65	65	90	90	120	120	150
65	80	30	50	50	80	80	110	110	145	145	180
80	100	35	60	60	100	100	135	135	180	180	225
100	120	40	75	75	120	120	160	160	210	210	260
120	140	50	95	95	145	145	190	190	240	240	300
140	160	60	110	110	170	170	220	220	280	280	350
160	180	65	120	120	180	180	240	240	310	310	390
180	200	70	130	130	200	200	260	260	340	340	430
200	225	80	140	140	220	220	290	290	380	380	470
225	250	90	150	150	240	240	320	320	420	420	520
250	280	100	170	170	260	260	350	350	460	460	570
280	315	110	190	190	280	280	370	370	500	500	630
315	355	120	200	200	310	310	410	410	550	550	690
355	400	130	220	220	340	340	450	450	600	600	750
400	450	140	240	240	370	370	500	500	660	660	820
450	500	140	260	260	410	410	550	550	720	720	900
500	560	150	280	280	440	440	600	600	780	780	1000
560	630	170	310	310	480	480	650	650	850	850	1100
630	710	190	350	350	530	530	700	700	920	920	1190
710	800	210	390	390	580	580	770	770	1010	1010	1300
800	900	230	430	430	650	650	860	860	1120	1120	1440
900	1000	260	480	480	710	710	930	930	1220	1220	1570

(2) Self-aligning rolling bearings with tapered bore μm

Nominal bore diameter d mm		Clearance									
		Group 2		Group 0		Group 3		Group 4		Group 5	
Over	To	min.	max.	min.	max.	min.	max.	min.	max.	min.	max.
18	24	15	25	25	35	35	45	45	60	60	75
24	30	20	30	30	40	40	55	55	75	75	95
30	40	25	35	35	50	50	65	65	85	85	105
40	50	30	45	45	60	60	80	80	100	100	130
50	65	40	55	55	75	75	95	95	120	120	160
65	80	50	70	70	95	95	120	120	150	150	200
80	100	55	80	80	110	110	140	140	180	180	230
100	120	65	100	100	135	135	170	170	220	220	280
120	140	80	120	120	160	160	200	200	260	260	330
140	160	90	130	130	180	180	230	230	300	300	380
160	180	100	140	140	200	200	260	260	340	340	430
180	200	110	160	160	220	220	290	290	370	370	470
200	225	120	180	180	250	250	320	320	410	410	520
225	250	140	200	200	270	270	350	350	450	450	570
250	280	150	220	220	300	300	390	390	490	490	620
280	315	170	240	240	330	330	430	430	540	540	680
315	355	190	270	270	360	360	470	470	590	590	740
355	400	210	300	300	400	400	520	520	650	650	820
400	450	230	330	330	440	440	570	570	720	720	910
450	500	260	370	370	490	490	630	630	790	790	1000
500	560	290	410	410	540	540	680	680	870	870	1100
560	630	320	460	460	600	600	760	760	980	980	1230
630	710	350	510	510	670	670	850	850	1090	1090	1360
710	800	390	570	570	750	750	960	960	1220	1220	1500
800	900	440	640	640	840	840	1070	1070	1370	1370	1690
900	1000	490	710	710	930	930	1190	1190	1520	1520	1860

Table 5: Recommended radial clearance of double-row cylindrical rolling bearings with cylindrical bore μm

Nominal bore diameter d mm		Clearance					
		Group 1		Group 2		Group 3	
Over	To	min.	max.	min.	max.	min.	max.
	24	5	15	10	20	20	30
24	30	5	15	10	25	25	35
30	40	5	15	12	25	25	40
40	50	5	18	15	30	30	45
50	65	5	20	15	35	35	50
65	80	10	25	20	40	40	60
80	100	10	30	25	45	45	70
100	120	10	30	25	50	50	80
120	140	10	35	30	60	60	90
140	160	10	35	35	65	65	100
160	180	10	40	35	75	75	110
180	200	15	45	40	80	80	120
200	225	15	50	45	90	90	135
225	250	15	50	50	100	100	150
250	280	20	55	55	110	110	165
280	315	20	60	60	120	120	180
315	355	20	65	65	135	135	200
355	400	25	75	75	150	150	225
400	450	25	85	85	170	170	255
450	500	25	95	95	190	190	285

Table 6: Recommended radial clearance of double-row cylindrical rolling bearings with tapered bore μm

Nominal bore diameter d mm		Clearance			
		Group 1		Group 2	
Over	To	min.	max.	min.	max.
	24	10	20	20	30
24	30	15	25	25	35
30	40	15	25	25	40
40	50	17	30	30	45
50	65	20	35	35	50
65	80	25	40	40	60
80	100	35	55	45	70
100	120	40	60	50	80
120	140	45	70	60	90
140	160	50	75	65	100
160	180	55	85	75	110
180	200	60	90	80	120
200	225	60	95	90	135
225	250	65	100	100	150
250	280	75	110	110	165
280	315	80	120	120	180
315	355	90	135	135	200
355	400	100	150	150	225
400	450	110	170	170	255
450	500	120	190	190	285

Rolling Bearings

Table 7: Radial clearance of four-row cylindrical rolling bearings (cylindrical bore) μm

Nominal bore diameter d mm		Clearance									
		Group 2		Group 0		Group 3		Group 4		Group 5	
Over	To	min.	max.	min.	max.	min.	max.	min.	max.	min.	max.
80	100	15	50	50	85	75	110	105	140	155	190
100	120	15	55	50	90	85	125	125	165	180	220
120	140	15	60	60	105	100	145	145	190	200	245
140	160	20	70	70	120	115	165	165	215	225	275
160	180	25	75	75	125	120	170	170	220	250	300
180	200	35	90	90	145	140	195	195	250	275	330
200	225	45	105	105	165	160	220	220	280	305	365
225	250	45	110	110	175	170	235	235	300	330	395
250	280	55	125	125	195	190	260	260	330	370	440
280	315	55	130	130	205	200	275	275	350	410	485
315	355	65	145	145	225	225	305	305	385	455	535
355	400	100	190	190	280	280	370	370	460	510	600
400	450	110	210	210	310	310	410	410	510	565	665
450	500	110	220	220	330	330	440	440	550	625	735
500	560	120	240	240	360	360	480	480	600	-	-
560	630	140	260	260	380	380	500	500	620	-	-
630	710	145	285	285	425	425	565	565	705	-	-
710	800	150	310	310	470	470	630	630	790	-	-
800	900	180	350	350	520	520	690	690	860	-	-
900	1000	200	390	390	580	580	770	770	960	-	-
1000	1120	220	430	430	640	640	850	850	1060	-	-
1120	1250	230	470	470	710	710	950	950	1190	-	-
1250	1400	270	530	530	790	790	1050	1050	1310	-	-

Table 8: Radial clearance of double-row and four-row tapered rolling bearings μm

Nominal bore diameter d mm		Group 1		Group 2		Group 0		Group 3		Group 4		Group 5	
		min	max	min	max	min	max	min	max	min	max	min	max
Over	To	min	max	min	max	min	max	min	max	min	max	min	max
-	30	0	10	10	20	20	30	40	50	50	60	70	80
30	40	0	12	12	25	25	40	45	60	60	75	80	95
40	50	0	15	15	30	30	45	50	65	65	80	90	110
50	65	0	15	15	30	30	50	50	70	70	90	90	120
65	80	0	20	20	40	40	60	60	80	80	110	110	150
80	100	0	20	20	45	45	70	70	100	100	130	130	170
100	120	0	25	25	50	50	80	80	110	110	150	150	200
120	140	0	30	30	60	60	90	90	120	120	170	170	230
140	160	0	30	30	65	65	100	100	140	140	190	190	260
160	180	0	35	35	70	70	110	110	150	150	210	210	280
180	200	0	40	40	80	80	120	120	170	170	230	230	310
200	225	0	40	40	90	90	140	140	190	190	260	260	340
225	250	0	50	50	100	100	150	150	210	210	290	290	380
250	280	0	50	50	110	110	170	170	230	230	320	320	420
280	315	0	60	60	120	120	180	180	250	250	350	350	460
315	355	0	70	70	140	140	210	210	280	280	390	390	510
355	400	0	70	70	150	150	230	230	310	310	440	440	580
400	450	0	80	80	170	170	260	260	350	350	490	490	650
450	500	0	90	90	190	190	290	290	390	390	540	540	720
500	560	0	100	100	210	210	320	320	430	430	590	590	790
560	630	0	110	110	230	230	350	350	480	480	660	660	880
630	710	0	130	130	260	260	400	400	540	540	740	740	910
710	800	0	140	140	290	290	450	450	610	610	830	830	1100
800	900	0	160	160	330	330	500	500	670	670	920	920	1240
900	1000	0	180	180	360	360	540	540	720	720	980	980	1300
1000	1120	0	200	200	400	400	600	600	820				
1120	1250	0	220	220	450	450	670	670	900				
1250	1400	0	250	250	500	500	750	750	980				

Rolling Bearings

Table 9: Radial clearance of four-point contact ball bearings μm

Nominal bore diameter d mm		Group 2		Group 0		Group 3		Group 4	
Over	To	min	max	min	max	min	max	min	max
-	18	15	55	45	85	75	115	105	145
18	40	26	66	56	106	96	146	136	186
40	60	36	86	76	126	116	166	156	206
60	80	46	96	86	136	126	176	166	216
80	100	56	116	96	156	136	196	176	236
100	140	66	136	116	176	156	216	196	256
140	180	76	156	136	196	176	236	216	276
180	220	96	176	156	216	196	256	236	296
220	260	115	195	175	235	215	295	275	335
260	300	135	215	195	275	255	335	295	355
300	350	155	235	215	295	275	355	335	415
350	400	175	265	245	325	305	385	365	465
400	500	205	305	285	385	355	455	435	525
500	600	255	355	335	445	425	545	525	615

Bearing Material

The performance and reliability of rolling bearings mostly depend on bearing material property. The rolling bearings are required to suffer large force repeatedly on the interface between rings and rolling elements, meanwhile, keep the high precision rotation. So it is required that the materials of the rings and the rolling elements possess the characteristics of hardness coinciding with loading capacity, anti-fatigue and anti-wear, and dimensional steady under different conditions of rolling contact and lubrication. Too much non-metallic impurity can cause fatigue and chapping easily. The less the impurity is, the cleaner the

materials as well as the longer life of rolling bearings will be.

Rings and rolling elements

High carbon chrome bearing steel is generally used for the rolling bearing rings and the rolling elements. The carburizing steel is used for the bearings with high impact load and alternating bending stress.

High carbon chrome bearing steel is the most widely used for the rolling bearings, which are required to adopt overall quenching way, the surface and bore of the bearing both are able to be hardened. Recently, the quality of the

bearing steel is being improved, the material property is improved greatly by vacuum degassed treatment and the oxygen content and non-metal content are reduced. Electroslag refining bearing steel with higher clean degree is used for bearings with long service life and high liability.

ZWZ heat treatment technology for rolling bearing rings and rolling elements ensures the dimensional steady under 120°C temperature. For higher operating temperature, special bearing heat treatment technology are demanded to ensure its dimensional steady. But this special technology will reduce bearing material's hardness and shorten bearing's fatigue life. For bearing whose operating temperature is more than 300°C, high temperature steel of hyperpyrexia hardness is used.

Cage

The cage is applied to embrace the rolling elements partially to ensure a distance between the two neighbor rollers, in order to reduce operating friction and generated heat, keep the same distance between rolling elements and distribute load equably and prevent rolling elements from falling off from separable bearings, as well as to guide rolling elements. The cages can take functions in lubrication grease storage to improve bearings' lubrication. For the cage material, it is required to bear operating vibration and impacting strength and to ensure small friction with rolling elements. The material should be light and suitable for bearing's operating temperature.

ZWZ rolling bearing cages can be divided into pressed cage, solid cage and pin cage.

Pressed cage

ZWZ pressed cage is generally made of cold-rolled and hot-rolled sheet steel which have

light weight and takes small space in bearings so that lubricant can go inside easily. Pressed cage is usually used in deep groove ball bearing, spherical rolling bearing and most tapered rolling bearing.

Solid cage

ZWZ solid cage is made of metal, phenolic bakelite and plastic.

Metal solid cage is usually made of brass, carbon steel and the etc. It is used in situations where cages of high strength are required and where the temperature is high.

Solid cage can be used where guide rib is needed. High speed bearing cage with guide rib is often made of light material, such as light alloy, phenolic bakelite and the etc. to endure its small inertia.

Plastic injection molding can be adopted when solid cage is made of glass fiber reinforced nylon 66 according to its outline suitable for the highest load requirement. Glass fiber reinforced nylon 66 has big flexibility, light weight and is suitable for vibration impact stress, acceleration or deceleration or mutual clapping of inner ring and outer ring. This bearing cage holds good property of lubrication and self-aligning. Cages made of glass fiber reinforced nylon 66 can be used in steady situations where the operating temperature is less than 120°C. Nylon will lose its flexibility under temperature lower than -40°C.

Pin cage

Linked by hollow roller, pin and gasket, pin cage is mostly used in large size cylindrical rolling bearings and tapered rolling bearings. The cage's weight is light and can accommodate more rollers and heavier load.

Rolling Bearings

The Limit Speed of Bearing

The rotation speed of the bearing is mainly restricted by the increase in temperature due to the frictional heat generated inside the bearing. When the rotation speed exceeds certain limit, the bearing shall fail to continue rotating due to the burns.

Limit rotation speed of the bearing indicates the limit value of the rotation speed when there is no frictional heat that leads to the burns and the bearing can continuously rotate.

Therefore, the limit rotation speed of the bearing is subject to the bearing type, dimensions, precision, lubrication method, quality and amount of lubricant, material and design of retaining cage, loading conditions and other factors.

The limit rotation speed for different types of bearings using grease lubrication and oil lubrication are respectively given in the dimension tables of these bearings. These values indicate the limit values of rotation speed of the normal design bearings under normal loading conditions (C/P ≥ 13, Fa/Fr ≤ 0.25 or so). In addition, the lubricant may be better than others in property, according to types and brand, but it may not be suitable for high speed rotation.

The Determination Method of Rolling Bearing's Limit Speed

Because of many factors influencing limit speed, there is no precise calculation method to define the limit speed of each kind of bearing. Only can put forward an approximate formula for calculating the limit speed according to the domestic and foreign usage

experience and test results. And provide the guidance to use reasonably. When choosing bearings, generally should not exceed the limit speed listed in sample books.

The limit speed listed in roller bearing sample books us given under certain assumptions, namely assume the equivalent dynamic load $P < 0.1C$ (C means rating dynamic load of bearing); Lubrication and cooling condition is normal; The radial bearing can only carry radial loads and thrust bearing can only carry axial loads; Bearing precision is Po.

Under the condition of the above assumptions, the bearing limit speed can be calculated by formula as below:

$$\text{For radial bearing: } n_j = \frac{f_1 A}{D_m}$$

$$\text{For thrust bearing: } n_j = \frac{f_1 A}{\sqrt{DH}}$$

In the formular:

- n_j —Limit speed of roller bearing (r/min)
- D_m —Bearing average diameter
- $D_m = 0.5(D+d)$
- d —Bearing inner diameter
- D —Bearing outer diameter
- H —Thrust bearing height
- f_1 —Dimensional factor that can check out according to D_m of radial bearing or \sqrt{DH} of thrust bearing in Figure 1;

The result is accurate to two digits and taken as in Table 2. When calculating the limit speed of needle bearing, D_m should be replaced by outer diameter of inner ring raceway. The value range of rlller bearing limit speed is listed in Table 2.

Table 1 Structural factor A (X10⁴)

Bearing type	Grease lubrication	Oil lubrication
Deep groove ball bearing		
Single row	48	60
Single row with dust cover	48	60
Single row with seal ring	34	-
Single row with felt von seal ring	24	-
Single row with filling slot	38	48
Double-row with filling slot	30	38
Needle bearing		
Without cage	9	12
With cage	24	36
With cage drawn cup	20	28
Spherical roller bearing	28	34
Angular contact ball bearing	45	60
Single row	32	43
Double row	32	43
Mounting in pairs	36	48
Four-point contact		
Separated type		
(Magneto bearing)	48	60
Self-aligning ball bearing	38	48
Short cylindrical roller bearing	43	53
Tapered roller bearing	30	38
Single row	22	28
Double row	18	22
Four-row	9	13
Thrust ball bearing	6.7	9
Cylindrical roller thrust bearing	6.7	9
Tapered roller thrust bearing	-	18
Self-aligning thrust roller bearing		

Rolling Bearings

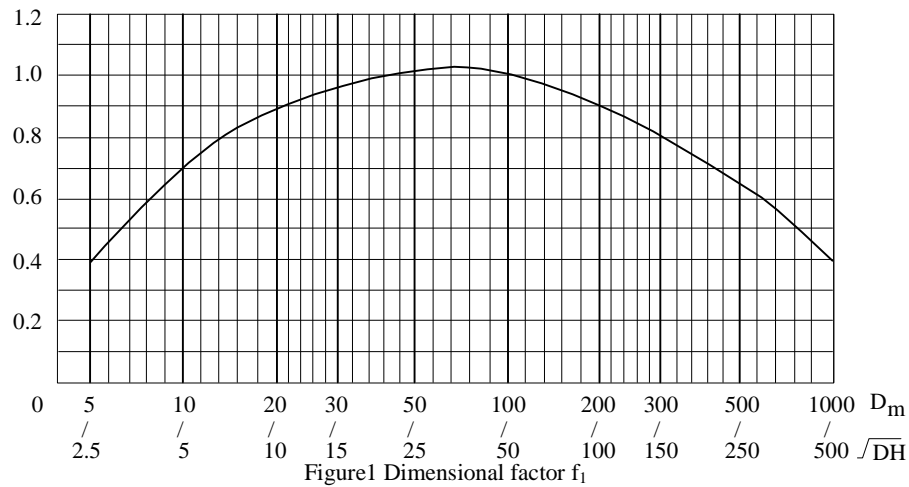

The Limit Speed of Rolling Bearing in Actual Application

There are many factors influencing limit speed, mainly these kinds as listed below:

(1) Load amount

When bearings running with load condition of $P > 0.1C$, the contact stress of rolling elements and raceway increases, temperature rises, which influence the lubricant performance. As a result, the limit speed listed in sample books will be multiplied by load factor f_2 as shown in Figure 2.

(2) Load type and direction

If radial bearings carry combined loads of radial load and axial load, because the number of rolling elements withstanding load

increase and large friction heat, then multiply the limit speed value listed in sample books with load distribution factor f_3 as shown in Figure 3.

(3) Lubricant and lubrication method

The limit speed listed in sample books belong to normal lubricating status, which means oil bath lubrication or drop lubrication, such as circulating oil lubrication, fog lubrication, splash lubrication, air-oil lubrication and so on. Then the limit speed of bearing can be improved by 1.5~2 times.

Experience proves that the limit speed can also be improved by enhancing bearing manufacture precision, increasing bearing clearance properly and adopting cage with special material and structure.

Table 2 Value range of limit speed

10	38	100	380	1000	3800	10000	38000
11	40	110	400	1100	4000	11000	40000
12	43	120	430	1200	4300	12000	43000
13	45	130	450	1300	4500	13000	45000
14	48	140	480	1400	4800	14000	48000
15	50	150	500	1500	5000	15000	50000
16	53	160	530	1600	5300	16000	53000
17	56	170	560	1700	5600	17000	56000
18	60	180	600	1800	6000	18000	60000
19	63	190	630	1900	6300	19000	63000
20	67	200	670	2000	6700	20000	67000
22	70	220	700	2200	7000	22000	70000
24	75	240	750	2400	7500	24000	75000
26	80	260	800	2600	8000	26000	80000
28	85	280	850	2800	8500	28000	85000
30	90	300	900	3000	9000	30000	90000
32	95	320	950	3200	9500	32000	95000
34	100	340	1000	3400	10000	34000	100000
36		360		3600		36000	

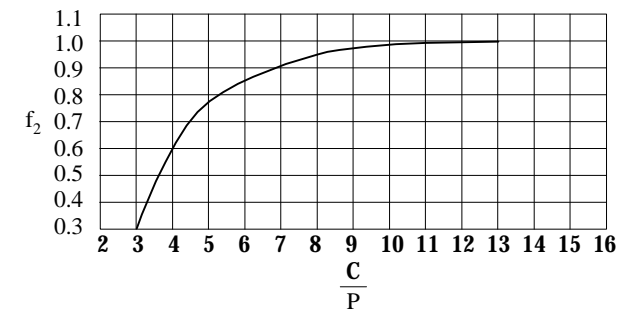

Rolling Bearings

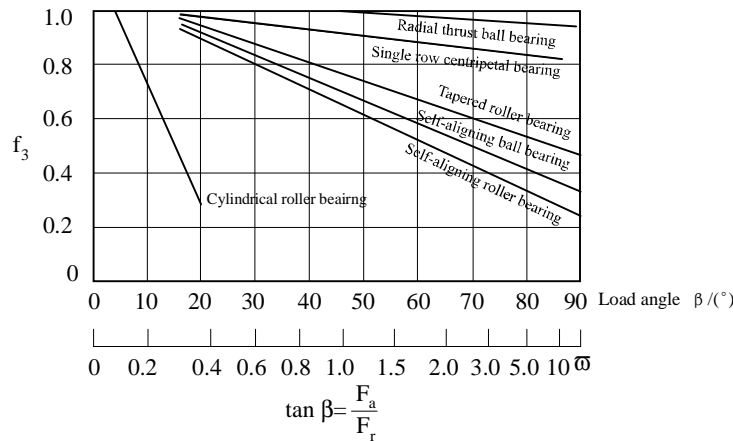

Figure 2 Load distribution factor f_3

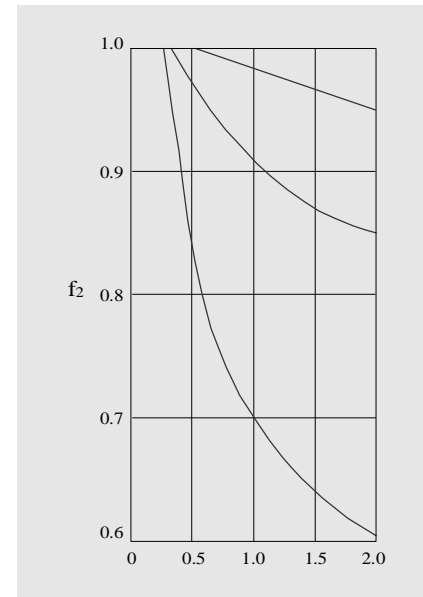

Figure 2: The correction factory f_2 relative to the combined load f_2

Correction of Limit Speed

When the loading condition is $P > 0.1C$, or when the axial load exceeds the radial load by over 25% in the combined load, the limit speed need to be corrected.

$$n_a = f_1 \cdot f_2 \cdot n \quad (1)$$

Where:

- na: the corrected limit rotational speed, rpm
- f1: the correction factor related to the loading condition (Figure 1)
- f2: the correction factor related to the combined load (Figure 2)
- n: the limit rotation speed under normal load conditions, rpm (see bearing dimension tables)
- C: the basic dynamic load rating
- P: the equivalent dynamic load
- Fr: radial load N{kgf}
- Fa: axial load N{kgf}

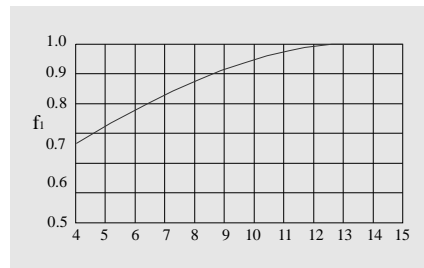

Figure 1: The correction factor f_1 relative to load condition f_1

- (1) Apply precision bearing
- (2) Analyze the internal clearance of the bearing (considering the reduction in internal clearance caused by the temperature increase)
- (3) Analyze the type of cage material (For high speed rotation, cages of copper alloy or PF resins are preferred. Cages of synthetic resins are also workable.)
- (4) Analyze the lubricating method (Circular lubrication, spurt lubrication, oil spray or gas lubrications are suitable for high-speed rotations.)
- (5) Or the cage made of cutting phenolic resin. In addition, also suitable for cage made of resin at a high rotation speed.

The Limit Speed of the Bearing with Sealing Ring

The limit rotation speed of the ball bearing with contact seals (RS type) is confined by the linear speed or the contact surface of the seals. The allowable linear speed depends on the rubber quality of the seals.

Precautions of High Speed Rotation

When the bearing rotates at high speed, especially at rotation speed approaching or exceeding the limit rotation speed given in the dimension tables, attention must be paid to the following issues:

Rolling Bearings

Friction and Temperature Rise of Bearing

Friction

Every friction can cause energy loss and hinder movement. Friction is the main reason for causing roller bearing heating, so it is also the key element to define working temperature of bearing. Friction depends on the load and several other factors in which the bearing type, size, rotation speed, lubricant property and lubricant amount are the most important. There are many reasons leading to friction, such as friction caused by sliding between rolling elements and raceway, sliding friction between rolling elements and ring flange, friction caused by seal parts and so on.

Approximate Calculation of Friction Torque

In order to be compared with the sliding bearing, the frictional torque of rolling bearings can be calculated according to the bore diameter of the bearings:

$$M = \mu P \frac{d}{2}$$

Where:

- M: Frictional torque {kgf.mm}
- μ: frictional factor (Table 1)
- P: bearing load N{kgf}
- d: nominal bore diameter of the bearing mm

The frictional factor μ is greatly influenced by the bearing type, load, rotational speed and lubrication and so on. The reference frictional factor under normal stable rotational conditions is given in Table 1. For sliding bearings, normally μ=0.01-0.02, sometimes 0.1-0.2.

Table 1 The frictional factor μ for different bearings

Bearing type	Frictional factor μ
Deep-groove ball bearing	0.0010- 0.0015
Angular contact ball bearing	0.0012- 0.0020
Self-aligning ball bearing	0.0008- 0.0012
Cylindrical rolling bearing	
Needle rolling bearings with full complement	0.0025- 0.0035
Caged needle rolling bearing	0.0020- 0.0030
Tapered rolling bearing	0.0017- 0.0025
Spherical rolling bearing	0.0020- 0.0025
Thrust ball bearing	0.0010- 0.0015
Spherical roller thrust bearing	0.0020- 0.0025

Temperature Rise

Friction loss of bearing almost changes into heat, so the bearing temperature rises. The quantity of heat caused by friction moment can be expressed as the following formula:

$$Q = 0.105 \times 10^{-6} M \cdot n$$

Q: Heat Kw
M: Friction moment N.m
n: Bearing rotation speed rpm

The heat produced and outflow heat keep balanced, then the bearing temperature will stay stable. Generally, temperature rises rapidly at the start of operation, but it will become stable when reaches normal condition. The bearing temperature will be different because of different generating heat, heat capacity of bearing boxing, cooling area, lubricating oil amount, environment temperature by the time of arriving stable condition. If it can not be stable and reach the stable condition, then it will be defined as abnormal. Reasons for abnormal temperature rise: too small bearing torque load and clearance, too big prepress, insufficient or sufficient lubricant, foreign matter coming into sealing device and so on.

Fit of Bearing

The Purpose of Fit

The purpose of fit is to make the inner ring or the outer ring fixed to the shaft or housing so that no bad circular slide shall happen on the fit surface.

The bad circular slide (called creep deformation) will bring about abnormal heat, scratches on the fit surface (hence making the ground iron power enter into the bearing), vibration and other problems, which cause the insufficient functioning of the bearing.

Therefore, since the bearing rotates with load, normally the rings must have interference fit so that they are fixed to the shaft or the housing.

Dimensional tolerances and fits of shaft and housing

The dimensional tolerance of the metric shaft and housing bore have been standardized in the GB/T275-93 *The fits of Rolling Bearings with Shaft and Housing*. If the dimensional tolerances are available, we can define the fit of the bearing with the shaft or the housing.

The fit relations between the dimensional tolerances of the shaft and housing bore and the bearings with PO class precision degree are given in Figure 1.

The Selection of Fit

The selection of fit is made according to the following principles.

According to the direction and nature of applied load and which of the two rings rotates, the load carried by each of the rings can be divided into rotational load, static load or indeterminate direction load. The ring carrying rotation load or indeterminate direction load should use

static fit (interference fit), and the ring carrying static load should use transitional fit or dynamic fit (clearance fit).

If the bearing load is big or there is vibrating or shock load, the interference fit should be increased. When using hollow shaft, bearing box with thin wall or light alloy or plastic bearing box, the interference should also be increased.

If high rotation precision is required, the high precision bearing should be used, and the dimension precision of the shaft or bearing box should be increased to avoid too much interference fit. If the interference is too big, the geometric precision of the shaft or bearing box shall affect the geometric shape of the bearing rings, and accordingly damage the bearing rotation precision.

If both inner ring and outer ring of non-separable bearing (such as deep groove ball bearing) adopt static fits, the mounting and dismounting of bearing is very inconvenient. It's better to adopt dynamic fit for inner ring or outer ring.

1) Effects of the load nature

According to its nature, bearing load can be divided into inner ring rotation load, outer ring rotation load and indeterminate direction load..

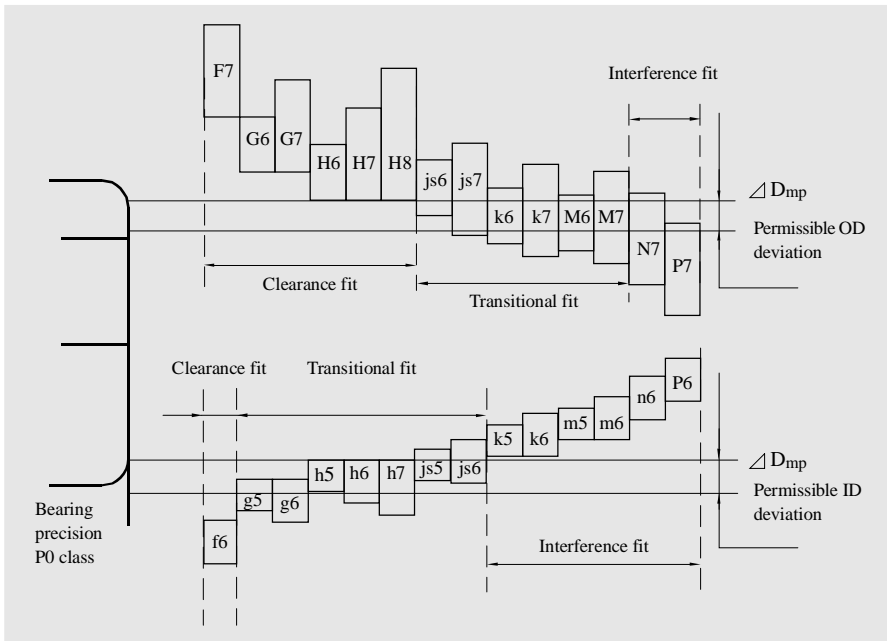

Figure1 Relations between dimension tolerances of shaft and housing bore and fit (bearings of PO class precision).

Table1 Nature of load and relations with fit

Bearing rotational conditions	Figure example	Nature of load	Fit choice
Inner ring: rotating Outer ring: static Direction of load: fixed	 Static load	I.R. rotating load	I.R.: use static fit (interference fit)
Inner ring: static Outer ring: rotating Direction of load: Rotating simultaneously with outer ring	 Unbalanced load	O.R. static load	O.R.: use dynamic (clearance fit)

Bearing rotational conditions	Figure example	Nature of load	Fit choice
Inner ring: static Outer ring: rotating Direction of load: fixed	 Static load	I.R. static load	I.R. use dynamic fit (clearance fit)
Inner ring: rotating Outer ring : static Direction of load: Rotating simultaneously with inner ring	 Unbalance load	O.R. rotating load	O.R. use static fit (interference fit)

2) Effects of load magnitude

For inner ring with radial load, it is both compressed and expanded in the radial direction, and the circumference tends to increase slightly, therefore the initial interference will decrease.

The amount of decrease can be calculated with the following formula:

$$[F_r \leq 0.25 C_0]$$

$$\Delta d_F = 0.08 \sqrt{\frac{d}{B}} \cdot F_r \times 10^{-3} \dots\dots\dots (1)$$

$$[F_r > 0.25 C_0]$$

$$\Delta d_F = 0.02 \frac{F_r}{B} \times 10^{-3} \dots\dots\dots (2)$$

Where:

- ΔdF: a mount of decrease of the interference, mm
- d: bearing nominal bore diameter, mm
- B: nominal bore width, mm
- Fr: radial load, N {kgf}
- C0: basic static load rating, N{kgf}

Therefore, when the radial load is a heavy one (exceeding the value of C0 by 25%), the fit must be tighter than that with light load. If there is the shock load, the fit must be even tighter.

3) Effects of the fit surface roughness

When taking the plastic deformation of the fit surface into consideration, the effective interference after fit is influenced by the processing quality of the fit surface. It can be approximately expressed with the following formula:

[ground shaft]

$$\Delta d_{eff} \approx \frac{d}{d+2} \Delta d \dots\dots\dots (3)$$

[turned shaft]

$$\Delta d_{eff} \approx \frac{d}{d+3} \Delta d \dots\dots\dots (4)$$

Rolling Bearings

Where:

- △deff: effective interference, mm
- △d: apparent interference, mm
- d: bearing nominal inner diameter, mm

4) Effects of temperature

Generally speaking, the bearing temperature in operation is higher than the surrounding temperature, and if the bearing rotates with load, the temperature of the inner ring is higher than that of the shaft, and the heat expansion shall reduce the effective interference.

Now assume the temperature difference between the inside of the bearing and the surrounding temperature of the housing is △t, we can presume that the temperature difference between the inner ring and the shaft on the fit surface is approximately (0.10~0.15)△t.

The reduced amount of interference caused by temperature change can be calculated with the following formula:

$$\Delta d_t = (0.10 \text{ to } 0.15) \Delta t \cdot \alpha \cdot d \approx 0.0015 \Delta t \cdot d \times 10^{-3} \dots\dots\dots (5)$$

Where:

- △dt: reduced amount of the interference caused by the temperature difference, mm
- △t: temperature difference between the inside of the bearing and the surrounding housing, °C
- a: linear expansion factor of bearing steel, (12.5x10⁻⁶)1/°C
- d: bearing nominal bore diameter, mm

Therefore, when the temperature of the bearing is higher than that of the shaft, the fit must be very tight. On the other hand, the interference between the outer ring and housing may increase due to the temperature difference or linear expansion factor difference. Hence it must be noted when considering using the slide in the fit surface between the outer ring and the housing to adapt to the expansion.

5) The maximum stress inside the bearing caused by the fit

When mounting the bearing with interference fit, sometimes the rings may expand or contract and then bring about stress.

If the stress is too big, the rings sometimes may break, to which attention must be paid.

The maximum stress inside the bearing caused by the fit can be calculated with the formula in Table2. As the reference value, it is safe to let the maximum interference not exceed 1/1000 of the shaft radius, or let the maximum stress should not exceed 120MPa {12kgf/mm²}.

6) Others

When a much higher accuracy is required, the precision level of the shaft and housing should be increased. Compared with shaft, it is more difficult to process the housing and the precision level is low. Therefore, the loosened fit between the shaft and the housing is recommended.

When using hollow shaft or thin wall-thickness, the fit must be tighter than normal.

When using two half housings, the fit with the outer ring must be loosened. For housing of cast aluminum or light alloy, the fit must be tighter than normal.

Table2 the maximum stress inside the bearing caused by fit

Shaft and inner ring	
(hollow shaft)	$s = \frac{E}{2} \cdot \frac{\Delta d_{eff}}{d} \cdot \frac{\left(1 - \frac{d_0^2}{d^2}\right) \left(1 + \frac{d^2}{D_i^2}\right)}{\left(1 - \frac{d_0^2}{D_i^2}\right)}$
(solid shaft)	$s = \frac{E}{2} \cdot \frac{\Delta d_{eff}}{d} \cdot \left(1 + \frac{d^2}{D_i^2}\right)$
Housing bore and outer ring	
(D _h ≠ ∞)	$s = E \cdot \frac{\Delta D_{eff}}{D} \cdot \frac{\left(1 - \frac{D^2}{D_h^2}\right)}{\left(1 - \frac{D^2}{D_h^2}\right)}$
(D _h = ∞)	$s = E \cdot \frac{\Delta D_{eff}}{D}$

- s: maximum stress, MPa {kgf/mm²}
- d: nominal bore diameter (shaft diameter), mm
- Di: inner ring raceway diameter, mm
Ball bearing Di=0.2(D+4d)
Rolling bearing Di=0.25(D+3d)
- △deff: effective interference of inner ring, mm
- do: hollow shaft radius, mm
- De: outer ring raceway diameter, mm
Ball bearing De=0.2(4D+d)
Rolling bearing De=0.25(3D+d)
- D: bearing nominal outer diameter (housing bore diameter), mm
- △Deff: effective interference of outer ring, mm
- Dh: housing outer diameter, mm
- E: modulus of elasticity 2.08x10⁵ MPa {21200 kgf/mm²}

Lubrication

Lubrication has important effects on the functions of the bearing. Whether the lubricant and the method are suitable or not shall influence the bearing life. That is to say, the lubrication is a necessary condition to assure the normal operation of bearing and the lubrication plays an important role in improving load-carry capability and service life of bearing.

The Purpose of Lubrication

The purpose of bearing lubrication is to form a thin grease film on rolling or sliding surfaces in order to prevent the direct contact with the metals.

The Effect of Lubrication

Reduce the friction of metals and slow down the wear.

The grease film formed expands the touching area and reduces the contacting stress.

Assure the rolling bearing can work normally under a high-frequency contact stress for a long time and elongates the bearing fatigue life.

Take away the heat generated by friction and reduce the temperature of bearing working surface in order to prevent burns.

Prevent the bearing from rust, dust and corrosion.

Methods of Lubrication

The lubricating methods of rolling bearing include oil lubrication and grease lubrication.

Oil Lubrication

Oil lubrication is applied to high-speed and

heat-resistant bearings and is effective for reducing vibration and lowering noise.

Oil lubrication has the following methods:

1). Oil drip lubrication

Oil drip lubrication can lubricate the bearing by dripping oil through the orifice of oil cup. The orifice of oil cup can be adjusted according to the magnitude of oil.

The advantage of lubrication method is the simple configuration and easy to use. But the disadvantage is that viscosity degree of oil can not be too high. Or it can not go through smoothly and influence the lubrication effect. So it is usually applied to rolling bearings with low speed and light load.

2). Oil bath lubrication

Oil bath lubrication can also be called soak oil lubrication that a part of bearing is dipped into the lubricant and make sure that every roller can be dipped into the lubricant when the bearing is working. Then the lubricant with rollers can go around other working parts of bearing. Considering the churning waste and temperature rise, in order to slow down the aging speed of lubrication, oil bath lubrication should not be adopted for the bearings with high rotation speed.

3) Splash lubrication

Splash lubrication is often adopted when rolling bearing works in closed gearing. It splashes the lubricant by using rotating parts, such as gear, swing oil plate and so on. The lubricant scatters on the bearing or flow into inside of rolling bearing through a designed oil groove along the box wall to lubricate rolling bearing. The used lubricant can mass again in the box for recycling. Since splash lubrication doesn't need any other accessorial equipment, it is

normally adopted by the gearing with simple and compact configuration. But the following three points should be paid more attention when using splash lubrication:

(1) The upside surface of the lubricant should not be too high, or the wastage caused by churning oil will be overmuch. And it can also cause granule abrasion because of the sediment such as grinding scraps taken from oil pool to bearing part when churning oil.

(2) The lubricant in the box should be often kept clean. Magnetism adsorber should be used in the oil pool to clear away grinding scraps and foreign matters for reducing granule abrasion.

(3) When designing the configuration, an oil trough for storing and a throttle orifice towards bearing could be set up against box wall to make bearing in the similar situation where they are oil bath lubricated and dripping oil lubricated for supplying lubricant and preventing from the lack of oil.

4) Oil cycling lubrication

Oil cycling lubrication is a way of actively lubricating for the parts of rolling bearing. It pumps the lubricant from oil box by a lift pump and transmits the lubricant into the rolling bearing supporting through an oil pipe and oil bore. Then the lubricant returns to the oil box through the orifice of bearing housing for reusing after being cooled and filtrated. Therefore, this method of lubrication can eliminate much more heat and simultaneously expel friction heat effectively. So it is applied to the bearing supporting with overload and high-speed rotation.

5) Oil jet lubrication

Oil jet lubrication is a kind of oil circulating

6). Oil mist lubrication

Oil mist lubrication is a kind of micro-lubricating. It meets the lubricating demand of rolling bearing with a spot of lubricant. Oil mist lubrication is to lubricate bearing with the oil mist that converted from lubricating oil in the oil mist generator. Actually, rolling bearing still keep the status of sparse lubricating condition since oil mist coagulate into oil droppings on the working surface of rolling bearing. To avoid the overmuch of oil supplying and increase of rolling bearing's working temperature caused by the augment of friction inside the oil, oil mist lubrication is normally adopted when the linear velocity of roller is quite high. Generally, the stress of oil mist is around 0.05~0.1bar. But the following two points should be paid much attention when adopt this lubrication method:

(1) The viscosity degree of lubricant should not exceed 340mm²/s (40°C) because exorbitant viscosity degree can not bring the effect of atomization.

(2) The oil mist after lubricating may spread with air partially and result in environment pollution. The oil mist should be collected by an oil-gas separator if necessary or eliminated by aerator.

7) Oil air lubrication

Use a piston quantitative distributor to transmit little oil to the constringent airflow inside the pipe at regular intervals and form a continuous flowing of oil against the wall of the pipe for supplying to bearing. The oil won't aging because of the new lubricant coming continuously.

Compressing the air can prevent the external impurities from breaking into the inside of bearing easily.

The little oil supplying can reduce the pollution to surrounding environment. Oil air lubrication use less oil than oil mist lubrication and has better stability, small friction moment, slowly temperature increasing. It is especially applied to high speed bearing.

Grease Lubrication

Grease lubrication put inside the bearing can last a comparatively long time without replenishment and the sealing device is very simple. Therefore, it is extensively applied.

There are two methods for grease lubrication: one is to put the grease inside the sealed bearings in advance. The other is to fill the certain amount of grease inside the housing and refill it or change the grease inside at intervals.

Besides, for machines with several bearings requiring lubrication, the method of centralized greasing through pipes connecting with the places to be lubricated is adopted.

The effect of grease lubrication is to put the grease onto every motional surface of rolling bearing directly. But when lubricating the raceway of rolling bearing and sliding surface, the principles below must be followed:

(1) To lubricate bearings adequately, the grease should impenetrate to the working surface and the interspace of bearing.

(2) Some of grease should be remained on the working surface of rolling bearing and last for a period of time. But overmuch loss of grease by flowing away should be prevented.

(3) The flowing direction of inputting and venting of grease should be according to the seal for it is propitious to the venting of contamination.

(4) Reduce the amount of grease at full steam

Rolling Bearings

when making sure well lubricated.

(5) Set up an exit hole at the end of flowing direction of grease in order to let the new grease can jostle the old one injected into the room and making sure the bearings are well lubricated.

The Selection Rules of Oil Lubrication

From the invalidation instance of oil lubricated rolling bearing, we can see most of invalidations are caused by the low viscosity degree of lubricant. The lower viscosity degree of lubricant is, the smaller carrying capacity of oil film owns and the easier oil film breaks, when the metal material connect each other directly and doing relative motions inside the rolling bearing and leading the bearing life is shorted for the increase of friction and abrasion or the burn and rupture accident occurs. But if the viscosity degree is overmuch, it can cause the increase of friction. So the quantity of heat increases when churning the lubricant, that is to say, the consumed energy of the system will increase. On the other hand, for working under the condition of high-speed, high load and high temperature, the rolling bearing may have special demand of antirust, antioxidant, wearability and the increase of lubricant adsorbability. Therefore, for selecting lubricant, it is mainly to ensure the viscosity degree and additive kind or different lubricant with some additive.

The following are general principles for selecting lubricant:

(1) Operating temperature

Operating temperature influences change of lubricant's viscosity and lubricating effect. So, when the operating temperature is lower, the

lower viscosity degree of lubricant should be selected; when the operating temperature is higher, the higher viscosity degree of lubricant or the lubricant with proper additive should be selected. For the different working temperatures, the viscosity degree of selected lubricant should varies synchronously. For example, much lower lubricant viscosity should be selected when lubricating bearings in north area or winter than in south area or summer. When the operating temperature varies frequently, the lubricant with excellent viscosity temperature quality should be selected. Namely, the viscosity degree of lubricant doesn't change a lot when the operating temperature ascending or descending to ensure that the thickness of oil film is controlled in a certain range steadily.

(2) Motion speed

The higher rotation speed, the lower viscosity of lubricating oil should be selected to avoid moving resistance and more heat generated. On the contrary, under the situation of the lower rotation speed, using the higher viscosity will be beneficial to improve the ability of load for bearings.

(3) Nature of the motion

In motion, there are impact, vibration, frequent changes of load ,speed and starting. Stop motion, rolling back frequently and intercourse or intermittence moving, they are not beneficial to form the oil film. Therefore, the lubricating oil with high viscosity should be adopted. Sometimes, would rather adopt lubricating grease, even the solid lubricating to make sure the reliable lubrication.

(4) Working load

The bigger load of rolling bearings carries, the higher viscosity of the lubricant's viscosity

should be selected, the better oiliness and extreme-pressure property of lubricating oil should be selected as well, to avoid squeezing the lubricating oil from the friction pair, or producing the direct contact of metal.

(5) Structure characteristics

The smaller rolling bearing's radial clearance is, the higher friction surface's processing precision is, the lower the viscosity of oil lubrication will be.

(6) Environment condition

When the bearing works under the condition of humid , corrosive gas, lower temperature, dust, intense radiation, the lubricating oil is easily to be polluted. So the lubricating oil which has feature of water resistance, anti-corrosion, cold-resistant, anti-radiate. When the circumstance is water pollution, latex spray, humid air or heavy dust, choose lubricating grease, generally not suitable for lubricating oil .

(7) Bearing precision

When the friction surface is crudity, generally, the high viscosity of oil lubrication should be selected so that it can carry partial relative high pressure caused by bad contact, but when the friction surface precision is high, the low viscosity of lubricant should be selected to reduce the unnecessary waste of energy loss and temperature rise.

(8) Bearing hardness

When the hardness of bearing motion friction surface is low, the high viscosity degree of lubricant should be selected and the amount of oil should be rich. Contrarily, the viscosity degree of lubricant could be reduced.

The Selection Rules of Grease Lubrication

Grease is made of thickener, additive and base oil. Base oil takes up about 70-95%, thickening agent takes about 30-50% and additive only in tiny percentage.

The method of choosing grease and oil are the same. It is mainly on the basis of bearing types and working conditions, for example the circumstance humidity, working temperature, speed parameter dmn, magnitude of load and the method of grease lubrication. Meanwhile, we should consider about some points below:

1) The dropping point of the grease should be 20-30°C higher than the working temperature to assure the lubricating effect.

2) Lubricating grease is not appropriate for circulation lube, because the grease flowability is bad, frictional resistance is big, mechanical efficiency is lower, heat conductivity coefficient is small . When the grease is used as dry oil for the concentrating lubrication, the cone penetration should be above 300 (1/10mm).

3) For the grease is not sensitive with normal temperature, and suitable for the different loads and high rotation speed, so mostly the grease are used in machine which is with high different temperatures and speed or with reverse and intermission movement. And they can also be used in the agriculture, architecture, mine field machine and so on.

4) Grease put inside the bearings is not easy to lose or be extruded, and needn't to be changed regularly. For these advantages they are easy to seal and they can seal themselves. The grease is mostly suitable for some special places which are better not to put in oil regularly, install complicated seal and can't be contaminated by the grease as well as high dust environment.

The general characteristics of grease normally used

Appellation	Brand No.	Titration temperature °C not lower than	Cone penetration	Operating temperature range °C	Characteristic and primary purpose
General lithium radicle grease	1	170	310~340	-20~120	Having anti-water and mechanical security. Normally used in the rolling and sliding part of machinery equipment. Grease is often adopted when lubricating rolling bearings.
	2	175	265~295		
	3	180	220~250		
Electrode tension lithium grease	0	170	355~385	-20~120	Having well mechanical security, anti-water, anti-permeating, electrode tension, extreme pressure antiwear property, the pumping capability. Normally used in the lubrication of heavy load machinery equipment, gear and bearings.
	1		316~340		
	2		265~295		
Calcium radicle grease	1	80	310~340	Temperatu<55	Often used in the bearing lubrication with small load and self-supporting lubricating. Also pint-sized machine in the lower temperature area.
	2	85	265~295		Be applied to medium-size and print-sized rolling bearing and the friction part of small load, high-speed machine in equipment with the temperature within 55°C.
	3	90	220~250		Medium motor rolling bearings, motor and friction part of medium load and medium rotating speed machine with the temperature below 60°C.

Appellation	Brand No.	Titration temperature °C not lower than	Cone penetration	Operating temperature range °C	Characteristic and primary purpose
Calcium radicle grease	4	95	175~205	Temperatu<55	Adopted by automotive water pump bearing, heavy load automatic machine bearing and other heavy load, low-speed machinery with the temperature below 60°C.
Calcium radicle grease	ZGN-1	120	250~290	80~100	Dissolving-resistant, water-resistant, with temperature 80 ~ 100°C (can not be used under low temperature). Railway engine, train, small size motor and dynamo as well as other high-temperature bearings.
	ZGN-2	135	200~240		

The Application of Bearing Precautions For Use

Compared with normal mechanical parts, rolling bearings have high precision levels and attention must be paid to their applications:

- 1) Keep the bearing and its surrounding environment clean.
- 2) Apply the bearings carefully. Carelessness may cause strong shock to the bearing and may lead to scratches and breaks to the bearing.
- 3) Use appropriate tools.
- 4) Pay attention to preventing from rusting. The bearings should not be used in moist places. Gloves should be worn to prevent the sweat drops adhere to the bearing.
- 5) The operators must know bearings well.
- 6) Application instructions must be formulated for correct usage of the bearings.

- The bearing preservation
 - The washing of the bearing and surroundings
- Inspection on the mounting dimensions and the processing quality
- Mounting operation
- Inspection after mounting
- Dismounting operation
- Maintenance (regular inspection)
- Replenishment of lubricate

The Storage of Bearing

The bearings are painted with rust-preventive oil and wrapped up with rust-preventive paper. The quality of the bearing can be ensured when the packaging is kept in good condition. It is recommended that the bearings are kept under air moist of 65% and in temperature 20°C and on shelves of 30cm above the ground

for long time storage. Besides, the storage should avoid direct sunshine and touching cold walls.

For the bearings with seals or shields, the characteristics of grease will be degraded after a long time storage. The bearings should be protected free of pollution and corrosion after they are taken out of original package.

The large size bearings should be placed horizontally and the whole side face of bearings shall be supported. If the bearings have a small thickness and are placed vertically, the dead weight of rings and rolling elements shall result in permanent bearing deformation.

The Mounting of Bearing

1. Preparation for the bearings

1.1 The ambient of bearing mounting

The mounting of bearing shall be done in dry and dust free room as possible and mounting work also shall be away from the equipments with metalworking or generating metal debris and dust. When the mounting must be done without any protections (large size bearings often experience this situation), proper measures must be taken to prevent the bearings from dust and humid air until the mounting is finished.

1.2 Preparation for the bearings

Do not open the packaging of the bearing until mounting operation since the bearing has received rust-prevention handling and been properly packaged. In addition, the lubricant applied on the bearing has good lubricating property. For bearings of general applications or bearings filled with lubricating grease, there is no need of washing before using the bearings. But for bearings applied to instruments or

rotating at high speed, washing with cleaning oil should be used to rid the bearings of the rust-preventive oil. In this case, the bearings may easily become rusty, therefore they should not be kept for a long time.

1.3 The preparation for mounting tools

The mounting tools should be made from wood or light metal and the materials, which can generate chips, shall be avoided to use. The mounting tools shall be kept clean.

1.4 The inspections on the shaft and housing

Wash the shaft and the housing to ensure that there are no burrs or scratches from machining. In no way should there be grinding agents (SiC, Al₂O₃ and so on), foundry sand and smear metal.

Then check if the dimensions, shapes and processing quality of the shaft and housing are in conformity with the drawings.

As shown in Figure 1 and 2, measuring should be done at several places. Also it is necessary to inspect the dimensions of the fillet and the verticality of the abutment. Before mounting, lubricate the qualified shaft and housing on all the fit surfaces.

Figure1 The measuring position of the shaft diameter

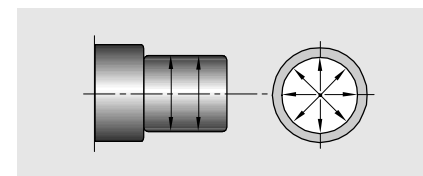
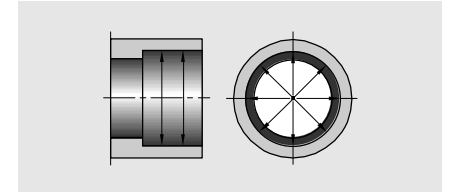

Figure 2 The measuring position of housing bore diameter



2. Classification of bearing mounting method

The mounting methods vary with the bearing types and fit conditions. Since in most cases it is the shaft that rotates, the inner ring and outer ring can use interference fit and clearance fit respectively. When the outer ring rotates, the interference fit should be used for it. The mounting methods can be divided into the following types when using interference fit, the details of which are shown in the following Table.

Rolling Bearings

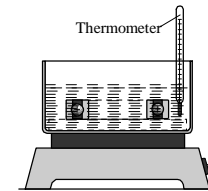
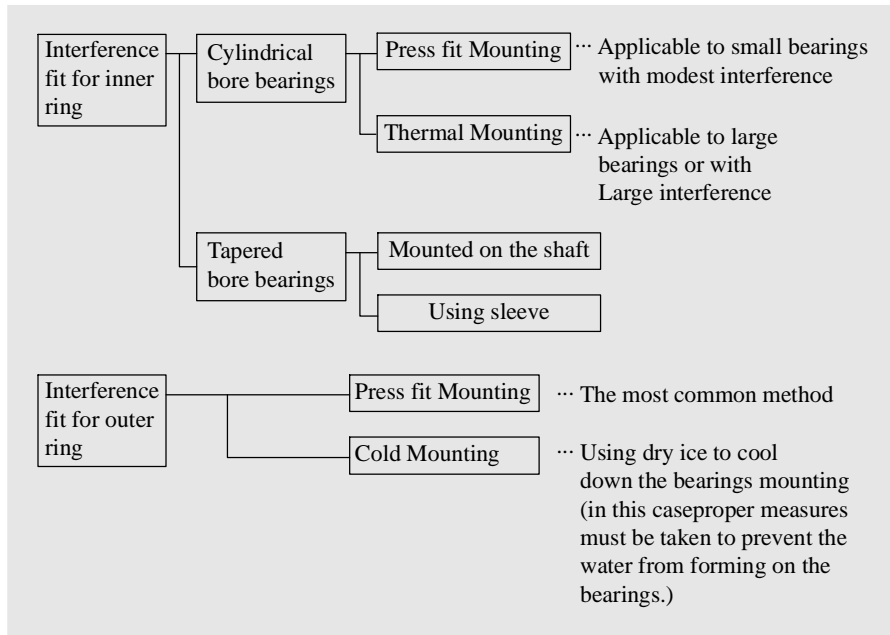

Heating by oil bath

The advantages of electric induction heating:

1. Clear, no pollution
2. Timing, constant temperature
3. Easy operation

When bearing is heated to the expected temperature (below 120°C), take it out and then mount it on the shaft quickly. Bearing will shrink along with cooling. Sometimes, the gap will occur between shaft shoulder and bearing end face, therefore the bearing should be pushed by tools towards shaft shoulder.

Due to the pre-lubricating grease or seal material has limitation with temperature, the heating temperature of the shielded or sealed bearing can not surpass 80* and also such bearings can not be heated by oil bath. Make sure temperature is distributed uniformly when heating the bearings and no overheated positions.

4. The mounting of tapered bore bearing
Most of the tapered bore bearings are mounted with interference fit of inner ring. Tapered bore bearing can be directly mounted to tapered shaft or to cylindrical shaft through adapter sleeve and withdrawal sleeve.

Interference degree is defined by checking clearance decreased volume or the axial displacement of the inner ring on tapered shaft. On certain circumstances, it can also be defined by testing lock angle of the locknut or the expansion volume of inner ring.

As for the tapered bore bearing, when the inner ring is pressed on the tapered shaft, adapter sleeve or withdrawal sleeve, interference degree will be increased and the radial clearance will be decreased. The interference degree can be defined through checking the decreased volume.

4.1 Measure the decreased clearance volume

The measure method of using feeler gauge to check the radial clearance before and after mounting is only suitable for medium size and the extra large size bearing. The measured clearance must be at the position between the unloaded rollers and the raceway of outer ring. Before measuring, running the outer ring for several revolutions, and make sure the central lines of the outer ring and roller group are overlapped. In the first measure, feeler gauge should have a measuring value lower than the minimum value of the clearance, and then choose a thicker feeler gauge to measure the clearance for several times till feeler gauge meets resistance in the following situation when being moved.

Before mounting——measuring place is between outer ring and the highest roller;
After mounting——measuring place is between inner ring (outer ring) and the lowest roller, according to different cages.

5. The mounting of outer ring

When mounting the outer ring to bearing box with interference fit, for the small size bearing, the outer ring can be pressed in normal temperature. When interference is big, the outer ring can be pressed through heating bearing box or cooling outer ring. When applying the dry ice or other refrigerant, the moisture in the air will agglomerate on the bearing, it must take the anti-rust measures.

3. The mounting of cylindrical bore bearing
3.1 Press fit mounting

Hydraulic press is normally used, sometimes adopt nuts and screws. Hammers can also be used if absolutely necessary.

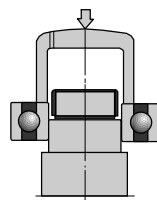

When inner ring of bearing is interference fit and need to be mounted on shaft, the pressure shall be applied on inner ring; When outer

ring of bearing is interference fit and need to be mounted in housing, the pressure shall be applied on outer ring. When both inner ring and outer ring are interference fit, a shim plate must be used to make sure pressure can be applied on both inner ring and outer ring simultaneously.

3.2 Thermal mounting

This method heats the bearings to make it expand and then mount the bearing on the shaft. It can prevent the bearing from being affected by unnecessary external forces and finish the mounting within very short time. The heating methods mainly are oil bath and induction.

Rolling Bearings

The Dismounting of Bearing

Dismounting of bearing is necessary for purposes of regular check and replacement of parts. Normally, the bearing shall be further used, as well as the shaft and bearing box. Therefore, dismounting must be considered during design in order not to damage bearing, shaft, bearing box or other parts. Tools for dismounting must be properly prepared. When dismounting the rings with static fit, the withdrawal force can only be applied to the said ring and should not work on the rings through rolling elements.

The dismounting tools of bearing

The most proper dismounting tools for bearing are press machine. When it is applied, it is necessary to check if the axial lines of lift part of press machine and the dismantled bearing are perpendicular with each other. In addition, there are some other simple manual dismounting tools for bearings and they are also useful and convenient.

The dismounting method of cylindrical bore bearing

As for the non-separable bearing, it should be dismantled firstly from the looser fit position (it is usual for the fit between outer ring and housing bore diameter), then pressed it out from the tight fit position by press machine. Provided the dismantled bearings would be used once again, it is not allowed to pass the dismounting force through rolling elements. Otherwise the rolling elements and raceway of ring will be damaged.

The dismounting of tapered bore bearing

The medium size and small size bearings mounted on the tapered shaft neck can be

easily dismantled through pulling the inner ring with normal a puller. If applying the automatical aligning puller, damage on the shaft neck can be avoided when pulling out the bearing.

The bearings dismantled from the tapered shaft neck become loose in short time. Therefore, certain equipment should be added to prevent the bearings dropping from the shaft.

It is a simple and practical method to dismantle the large size bearings on the adapter sleeve by the hydraulic nut, but the bearing should be leaned against a supporting ring. Filling oil is a simpler way to dismantle, but the adapter sleeve must have oil raceway and oil slot. When dismantling the bearings on the withdrawal sleeve, it is a must to dismantle some axial lock equipments firstly, such as locknut and end gap, etc. As for the medium size and small size bearings, they can be dismantled by locknut, hook type wrench or punch wrench.

The Maintenance of Bearing

Regular maintenance (regular check) must be carried out to ensure the play of the functions within a long time period.

Regular check is very important to improve the productivity and economy by finding the trouble or problem before such occurrence.

Washing

Make appearance records of the bearings by photo or other methods before dismantling and check the bearings.

In addition, ensure the amount of lubricant left inside the bearing and analyze the lubricant by sampling before washing the bearing.

The bearing can be washed roughly or carefully, and a metal net or rack can be used in the bottom of container.

For rough washing, use a brush in the oil to clean the lubricant or any adhesive away. Rotating the bearing at this moment may damage the bearing surface due to the foreign matter inside.

For careful washing, rotate the bearing in the oil slowly and carefully.

The normally used cleaning agent is of neural nature, without water, diesel oil or kerosene. Sometimes lukewarm alkali liquid is used upon necessity.

Filtering of the cleaning agent is required to keep clean no matter which agent is used. Paint immediately the rust-preventing oil or grease on the bearing after washing.

Check and make judgment

In order to judge whether the dismantled bearing can be reused or not, the dimensional precision, rotational precision, internal clearance should be especially checked, as well as the interference fit surface, raceway surface, rolling surface, cage and seals and so on. Concerning the results of such checks, please consult the bearing specialist for judgement.

The criteria for judgement vary with the mechanical functions and importance and the regularities of the checks. Replacement of the bearing must be done in case of the following damages:

There are cracks or defects on the bearing parts.

There are peelings-off from the raceways or the rolling surface.

Identification of Bearing Problems

It is important for improvement in productivity and economy to identify or predict if there are any problems or troubles inside the bearing without dismantling it for check purposes.

The main identification methods are as below:

1) Identification through sound

Rich experience is required to identify the bearing problems or troubles by listening to the sound of the bearing. Much training in this respect is entailed to tell the sound of the bearing or that of other parts. It is recommended that a special worker should be responsible for this job. The sound of the bearings can be heard clearly when putting a stethoscope or the rod on the housing.

2) Identification through working temperature

This method uses comparisons, and is applied only in cases without big changes when the bearing is rotating. Therefore, continuous records of the temperature must be kept. The temperature not only increases but also presents irregular changes in case of trouble.

It is preferred to use these two methods together.

3) Identification through the status of the lubricant

Identify the trouble by taking samples of the lubricant and analyzing the dirty level and whether there is any foreign matter or metal particles inside. This method is especially effective for bearings that can not be approached for inspection or the large bearings.

Rolling Bearings

The Damages and Solutions of Bearing

There is no method to view directly when the bearing is operating, but it can be known abnormity by the status of noise, vibration, temperature and lubricant. Typical bearing injury examples are listed in following table:

Item	Appearance	Possible reason	Solution
Peeling off	Peeling off and deformation of the rotational surface	Load too heavy or improper applications Mal-mounting Poor precision of the shaft or bearing box Clearance too small Intrusion of foreign matters Rusting Hardness decrease caused by abnormal high temperature	Re-consider the application conditions Consider other bearing specifications Re-consider the clearance Check the processing precision of the shaft and bearing box Consider the surrounding design Check the mounting method Check the lubricant and lubricating method
Burns	Overheat color varying, then burning, leading to failure to rotate	Clearance too small (including clearance for the deforming part) Insufficient lubrication or inappropriate lubricant Load too heavy (pre-load too heavy) Skewing rollers	Choose proper clearance (increasing clearance) Check lubricant type and ensuring amount Check application conditions Avoid positioning error Check surrounding design (including heat to bearing) Improve the mounting method
Cracks	Partial breach and even cracks	Shock load too heavy Interference too big Big peeling off and frictional cracks Poor precision of the mounting side (corner circle too big) Frictional cracks Mal-applications (using copper hammer, intrusion of big foreign matter)	Check the application conditions Set proper interference and check material quality Improve mounting and application method Prevent frictional cracks (check lubricants) Check bearing surrounding design

Item	Appearance	Possible reason	Solution
Cage damage	Loosening or broken rivet Broken cage	Torque load too big High speed rotation or speed changing too frequently Poor lubrication Intrusion of foreign matter Vibration too big Bad mounting (mounting in learning conditions) Abnormal increase in temperature (resin cage)	Check application conditions Check lubrication conditions Re-consider choice of cage Pay attention to application Consider rigidity of shaft and bearing box
Scratches	Rough surface with small deposit Scratches between the flanges of rings and the side surfaces of the rollers	Poor lubrication Intrusion of foreign matter Skewing rollers caused by learning Axial load too big leading to no lubricant on flange surface Roughness of the surface too big Big sliding of the rolling elements	Re-consider lubricant and lubricating method Check application method Set proper pre-load Reinforce the sealing function Use bearings correctly
Rusting corrosion	Rusting on all or part of the surface Rust on rolling elements in pitch shape	Poor maintenance Improper packaging Insufficient rust-preventive Intrusion of moist acid liquid Taking the bearing by hands	Maintenance to prevent rusting Reinforcing the sealing function Check the lubricant regularly Pay attention to bearing application
Corrosion	Red corroded particles in the fit surface	Insufficient amount of interference Small bearing oscillating angle Insufficient lubrication (or without lubrication) Not stable load Vibration in the transit	Check the interference and the condition of the lubricant Separable packing of inner rings and outer rings when in transit, pre-load shall prevail if the bearings are un-separable Re-consider choice of lubricant Re-consider choice of bearings

Item	Appearance	Possible reason	Solution
Wear	Surface worn, leading to dimension changes with scratches and traces	Foreign matters in the lubricant Poor lubrication Rollers skewing	Check lubricant and lubrication method Reinforce sealing function Prevent positioning error
Electric corrosion	Crater-like pits on the rolling surface and possible development of corrugation shape	Electrical current in the rolling surface	Use current by-pass value Adopt insulation to avoid current passing through inside of the bearing
Dent and bruise	Intrusion of solid foreign matter or pits in the surface caused by shock or scratches from mounting	Solid foreign matter intrusion Peels inside the bearing Shock from mal-mounting Peeling off Mounting in learning conditions	Improve mounting and application methods Prevent foreign matters from intruding Check other parts if caused by metal pieces
Creep deformation	Slippery ID surface and OD surface leading to mirror surface and sometimes blocking	Insufficient interference at the fit surface Sleeve not fastened enough Abnormal increase in temperature Load too heavy	Re-consider the interference amount Consider the application conditions Check precision of shaft and bearing box

Deep Groove Ball Bearing

Product Characteristics

Deep groove ball bearing consists of four basic parts, which are inner raceway (inner ring), outer raceway (outer ring), steel balls and cage. With normal rotation, inner raceway, outer raceway and steel balls accommodate the load while the cage plays a role in separating the balls and keeping stable. Single-row deep groove ball bearing has a simple structure, non-split inner ring and outer ring and easy to be used so it is widely used bearing in machinery industry such as precision meter, low noise electric motor, automobile, motorcycle, woodworker, transmission shaft of textile machinery, mining machinery, electromechanical equipments, plastic machinery, office equipments, medical equipments, fitness equipments, national defense industry, aeronautic industry, aerospace industry, excise equipments and other general machinery. Single-row deep groove ball bearing is mainly used for accommodating radial load and certain axial load. When this bearing is given a larger radial clearance, this bearing will have a feature as radial thrust bearing to carry larger axial load and also can limit the axial movement in two directions. Different clearances allow a relative misalignment of inner ring and outer ring ranging from 8' to 16'.

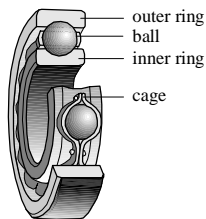

(Deep groove ball bearing)

Product Category

ZWZ manufactures following categories of Deep groove ball bearing currently:

- Single-row deep groove ball bearing
- Single-row deep groove ball bearing with shield(s)
- Single-row deep groove ball bearing with seal(s)
- Single-row deep groove ball bearing with snap groove or snap ring on outer ring

Single-row deep groove ball bearing is used for the applications without special requirements for mounting, sealing and interface.

Single-row deep groove ball bearing with shield(s) is used for the applications with difficulties in lubricating and checking lubrication or special situations. There is gap between shield(s) and inner ring. Single-row deep groove ball bearing with two shields has been filled with lubricant when manufacturing so it is unnecessary to wash and fill lubricant before mounting. It is also unnecessary to add lubricant within lubricating period during operating.

Single-row deep groove ball bearing with seal(s) has a seal or seals with steel frame. The seal is contact type and has a more superior waterproof property than Single-row deep groove ball bearing with shield(s). However, the rotational speed of this bearing is lower than Single-row deep groove ball bearing with shield(s) due to the larger friction force. Single-row deep groove ball bearing with snap groove or snap ring on outer ring simplifies the mounting in housing as a result of positioning with snap ring in axial direction.

Dimension Range

The basic dimensions of Deep groove ball bearing manufactured by ZWZ are listed in dimension table.

- Dimension range of bore diameter: 10mm - 1320mm
- Dimension range of outer diameter: 30mm - 1600mm
- Dimension range of overall width: 9mm - 300mm

Tolerance

The standard tolerance of Deep groove ball bearing manufactured by ZWZ is Class normal, which conforms to GB307.1. Please refer to tolerances listed in the table of preface pages.

Radial Clearance

The standard internal clearances of Deep groove ball bearing manufactured by ZWZ are C2, normal (C0), C3, C4 and C5, which conforms to GB4604. Please refer to radial clearances listed in the table of preface pages. The values are available for the bearings before mounting or without load.

The bearings with internal clearance larger or lower than standard values also can be developed.

X, Y factors please see following table:

Fa/Co	Normal					C3			C4						
	Fa/Fr ≤ e		Fa/Fr > e		e	Fa/Fr ≤ e		Fa/Fr > e		e	Fa/Fr ≤ e		Fa/Fr > e		e
	X	Y	X	Y		X	Y	X	Y		X	Y	X	Y	
0.025	1	0	0.56	2.0	0.22	1	0	0.46	1.74	0.31	1	0	0.44	1.42	0.39
0.04	1	0	0.56	1.8	0.24	1	0	0.46	1.61	0.33	1	0	0.44	1.36	0.41
0.07	1	0	0.56	1.6	0.27	1	0	0.46	1.46	0.36	1	0	0.44	1.27	0.44
0.13	1	0	0.56	1.4	0.31	1	0	0.46	1.30	0.41	1	0	0.44	1.17	0.46
0.25	1	0	0.56	1.2	0.37	1	0	0.46	1.14	0.47	1	0	0.44	1.05	0.53
0.5	1	0	0.56	1.0	0.44	1	0	0.46	1.00	0.54	1	0	0.44	1.00	0.56

Dynamic Equivalent Load:

$$P_0 = Fr \text{ [kN]} \quad Fa/Fr \leq 0.8$$

$$P_0 = 0.6Fr + 0.5Fa \text{ [kN]} \quad Fa/Fr > 0.8$$

Cage

Deep groove ball bearing has stamped steel cage or solid brass cage. When outer diameter is lower than 400mm, stamped steel cage is adopted without suffix after basic bearing number. When outer diameter is larger than 400mm, solid brass cage is adopted without suffix after basic bearing number.

Allowable Angle Error

Deep groove ball bearing allows different relative misalignments of inner ring with outer ring by radial clearance as follows:

Radial clearance	Allowable angle error
Normal	8'
C3	12'
C4	16'

Dynamic Equivalent Load:

$$P = XF_r + YF_a \text{ [kN]}$$

In the formula:

Fr: Radial load [KN]

Fa: Axial load [KN]

Deep Groove Ball Bearing**ZWZ****Supplement Code**

The definition of suffix code for deep groove ball bearing as follows:

- CN Normal group radial clearance, normally only for combine with following numbers to express relative narrow or the range of deviate.
- H The range of narrow clearance, equals to the upper half range of original clearance.
- L The range of narrow clearance, equals to the lower half range of original clearance.
- P The range of deviated clearance, equals to the upper half range of original clearance and the lower half of next group clearance.

The letters above can also applicable to combine with following clearance group to respective meanings: C2,C3,C4 & C5, for example: C2H

- C2 Radial clearance smaller than normal group.
- C3 Radial clearance larger than normal group
- C4 Radial clearance larger than C3
- C5 Radial clearance larger than C4
- DB Two sets of single-row deep groove ball bearings with back to back arrangement
- DF Two sets of single-row deep groove ball bearings with face to face arrangement
- DT Two sets of single-row deep groove ball bearings with tandem arrangement
- E Internal design changed, enhanced structure
- J Pressed steel sheet cage
- M Brass solid cage, steel ball guided. The different design and material is identified by adding numbers after the letter M, such as M2
- MA Brass solid cage, outer ring guided.
- MB Brass solid cage, inner ring guided
- MT33 MT33 Lithium base grease. NLGI viscosity grade 3, temperature range -30°C to +120°C (standard filling amount)
- MT47 MT47 Lithium base grease. NLGI viscosity grade 2, temperature range -30°C to +110°C (standard filling amount)
- N Outer ring with snap groove
- NR Outer ring with snap groove and snap ring
- N1 Outer ring endface with groove
- P5 Dimensional accuracy and rotating accuracy comply with ISO tolerance grade 5
- P6 Dimensional accuracy and rotating accuracy comply with ISO tolerance grade 6
- P52 P5+C2
- P62 P6+C2
- P63 P6+C3
- RS Bearing with frame system rubber seal ring (contact type)

2RS Bearing with RS sealed on both sides.

RS1 Bearing with frame system rubber seal ring (contact type), the material of seal ring is sulfureted rubber

2RS1 Bearing with RS1 sealed on both sides

RS2 Bearing with frame system rubber seal ring (contact type), the material of seal ring is fluoride rubber

2RS2 Bearing with RS2 sealed on both sides.

RZ Bearing with frame type rubber sealing ring (non-contact type)

2RZ Bearing with RZ sealed on both sides.

Z Bearing with shield on one side.

2Z Bearing with shields on both sides.

ZN Z+N Shield with the different side of snap groove

ZNR Z+NR Shield is on the other side of snap groove and snap ring.

ZNB Z+NB Shield is on the same side of snap groove.

ZNBR Z+NR Shield is on the same side of snap groove and snap ring.

2ZN 2Z+N Bearing with shields on both sides, outer ring with snap groove.

2ZNR 2Z+NR Bearing with shields on both sides, outer ring with snap groove and snap ring.

TH Glass fibre-reinforced phenolic resin cage (tube shape)

V Full complement rolling element (without cage)

Deep Groove Ball Bearing

d 10–26 mm

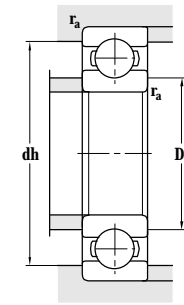
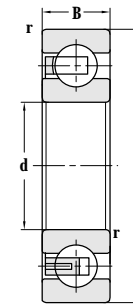
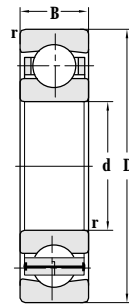
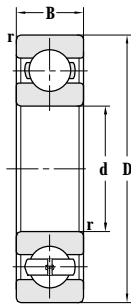

Principal dimensions				Basic load ratings		Limit speed ratings	
d	D	B	r _{min}	C _r	C _{or}	Grease	Oil
mm				kN		r/min	
10	30	9	0.6	6.50	3.00	24000	30000
12	32	10	0.6	6.50	3.00	22000	28000
15	35	11	0.6	8.00	4.00	19000	24000
17	40	12	0.6	9.10	5.00	17000	20000
	47	14	1	13.6	6.60	16000	19000
	47	14	1	13.6	6.60	16000	19000
	47	14	1	13.6	6.60	16000	19000
20	47	14	1	13.0	6.70	15000	18000
	47	14	1	13.0	6.70	15000	18000
	62	16	1	18.2	10.0	13000	16000
22	56	16	1.1	17.8	9.25	13000	16000
23	52	13	1	17.7	9.35	13000	16000
	56	15	1	18.5	9.30	12000	15000
	56	15	1	18.5	9.30	12000	15000
25	37	7	0.3	4.2	2.64	16000	19000
	42	9	0.3	7.30	4.55	16000	19000
	42	9	0.3	7.30	4.55	16000	19000
	47	12	0.6	11.4	6.28	15000	18000
	47	8	0.3	8.00	5.00	14000	17000
	47	12	0.6	10.0	5.85	14000	17000
	52	15	1	14.3	8.00	12000	15000
	52	15	1	14.3	8.00	12000	15000
	52	18	1	14.0	7.90	12000	15000
	62	17	1.1	22.4	11.5	11000	14000
	62	17	1.1	22.4	11.5	15000	19000
	68	18	1.1	26.3	12.9	11000	14000
	80	21	1.5	37.5	19.0	9000	11000
	26	68	19.5	2	40.3	17.0	9500

Designations	Abutment and fillet dimensions			Weight
	D _{smin}	dh _{max}	r _{amax}	
	mm			kg
6200	14	26	0.6	0.0277
6201	16	28	0.6	0.0365
6202	19	31	0.6	0.0431
6203	21	36	0.6	0.0661
6303-WCH	22.6	41.4	1	0.110
6303-WC	22.6	41.4	1	0.110
6303-BYD	22.6	41.4	1	0.110
6204	25	42	1	0.110
6204TN1	25	42	1	0.104
6304X3/C3	28	54	1	0.252
63/22/C3	29	47	1	0.183
62/23-BYD	29	43	1	0.117
66/23/P53YB2	29	47	1	0.169
66/23/P53Z2	29	47	1	0.172
61805	27	35	0.3	0.0227
61905	27	40	0.3	0.0415
1000905	27	40	0.3	0.0415
6005	29	43	0.6	0.078
16005	27	45	0.3	0.0562
FL-6005/C3	29	43	0.6	0.0787
6205	30	47	1	0.134
6205TN1	30	47	1	0.126
62205	30	47	1	0.159
6305	31.5	55.5	1	0.214
FL-6305/P6	31.5	55.5	1	0.214
6305X3/C3YA5	33	62	1	0.296
6405	33	72	1.5	0.530
6605X2WB TN1/HA	33	61	2	0.272

Deep Groove Ball Bearing

d 28-40 mm

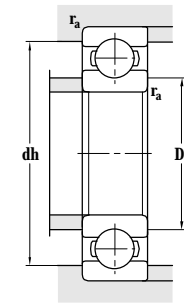
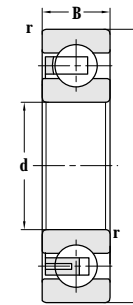
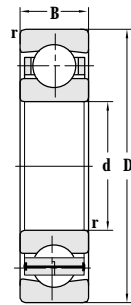
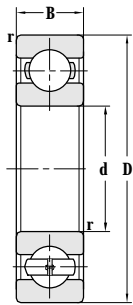

Principal dimensions				Basic load ratings		Limit speed ratings	
d	D	B	r _{min}	C _r	C _{or}	Grease	Oil
mm				kN		r/min	
28	68	18	1.1	32.5	13.0	9500	12000
	68	18	1.1	24.6	13.0	9500	12000
28.575	71.438	20.638	1.1	23.6	13.3	9400	11700
30	47	9	0.3	7.50	4.95	14000	17000
	55	9	0.3	10.6	6.75	12000	15000
	55	13	1	13.2	7.96	12000	15000
	59	22	0.4	13.0	8.00	10000	13000
	62	16	1	19.5	11.3	10000	13000
	72	19	1.1	28.4	15.4	9000	11000
	72	19	1.1	28.4	15.4	9000	11000
	90	23	1.5	44.5	23.0	8500	10000
33	72	17	1.1	22.5	13.6	9100	11000
35	47	7	0.3	3.90	3.00	13000	16000
	55	10	0.6	9.35	6.70	11000	14000
	62	14	1	16.0	10.3	10000	13000
	72	17	1.1	26.0	14.7	9000	11000
	80	21	1.5	33.4	19.2	8500	10000
	80	21	1.5	33.4	19.2	8500	10000
40	62	12	0.6	13.0	9.20	10000	13000
	68	15	1	16.8	11.6	9500	12000
	68	15	1	16.8	11.6	9500	12000
	80	18	1.1	31.2	18.2	8500	10000
	80	18	1.1	31.2	18.2	8500	10000
	80	18	1.1	31.2	18.2	8500	10000
	80	18	1.1	31.2	18.2	8500	10000
	80	18	1.1	31.2	18.2	8500	10000
	90	23	1.5	41.0	24.0	7500	9000
	90	23	1.5	41.0	24.0	7500	9000
	90	23	1.5	41.0	24.0	7500	9000
	90	23	1.5	41.0	24.0	7500	9000

Designations	Abutment and fillet dimensions			Weight
	D _{smin}	dh _{max}	r _{amax}	
	mm			kg
63/28/HA	34.5	61.5	1	0.299
63/28	34.5	61.5	1	0.301
66/28X4	35	65	1	0.396
61906	32	45	0.3	0.0433
16006	32	53	0.3	0.0827
6006	34.6	50.4	1	0.121
1-0005	33	55	0.4	0.191
6206	35	57	1	0.218
6306	36.5	65.5	1	0.354
6306TN1	37	65	1	0.342
6406	38	82	1.5	0.805
62/33	40.5	64.5	1	0.308
61807	37	45	0.3	0.0292
61907	38.2	51.8	0.6	0.0779
6007	40	57	1	0.152
6207	41.5	65.5	1	0.294
6307	43	72	1.5	0.456
6307TN1	43	72	1.5	0.443
6407	43	92	1.5	0.919
61908	43.2	58.8	0.6	0.108
6008	44.6	63.4	1	0.191
6008/C3	44.6	63.4	1	0.191
6208	46.5	73.5	1	0.369
6208/P6	46.5	73.5	1	0.361
6208/HAP6	46.5	73.5	1	0.361
6208/P5YB2	46.5	73.5	1	0.361
370208	46.5	73.5	1	0.362
6308/P5YB2	48	82	1.5	0.642
6308	48	82	1.5	0.642
6308TN1	48	82	1.5	0.611
6308/HA	48	82	1.5	0.642

Deep Groove Ball Bearing

d 40-50 mm

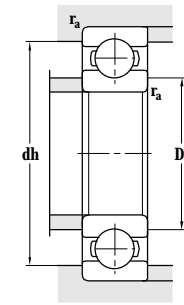
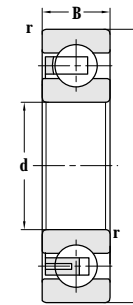
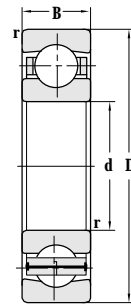
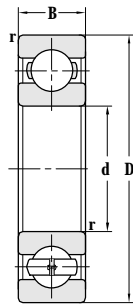

Principal dimensions				Basic load ratings		Limit speed ratings	
d	D	B	r _{min}	C _r	C _{or}	Grease	Oil
mm				kN		r/min	
40	90	23	1.5	41.0	24.0	7500	9000
	110	27	2	67.5	36.0	6700	8000
41	80	17	1.1	23.7	19.0	8500	10000
	80	17	1.1	29.1	17.9	8500	10000
45	58	7	0.3	6.50	5.00	9500	12000
	75	10	0.6	14.9	11.4	9000	11000
	75	16	1	20.0	14.0	9000	11000
	85	19	1.1	33.7	20.7	7500	9000
	85	19	1.1	33.7	20.7	7500	9000
	85	19	1.1	33.7	20.7	7500	9000
	85	19	1.1	33.7	20.7	7500	9000
	85	19	1.1	33.7	20.7	7500	9000
	85	19	1.1	33.7	20.7	7500	9000
	85	19	1.1	42.5	32.0	7500	9000
	90	20	1.1	41.0	24.4	7000	8500
	100	25	1.5	52.5	30.0	6700	8000
	100	25	1.5	52.5	30.0	6700	8000
	100	25	1.5	52.6	30.1	6700	8000
	100	25	1.5	52.7	30.2	6700	8000
	100	25	1.5	52.5	30.0	6700	8000
	100	25	1.5	52.5	30.0	6700	8000
100	25	1.5	52.5	30.0	6700	8000	
100	25	1.5	52.5	30.0	6700	8000	
120	29	2	73.0	43.0	6000	7000	
50	72	12	0.6	13.9	11.0	8500	10000
	80	10	0.6	15.4	12.3	8500	10000
	80	16	1	22.0	16.3	6500	10000
	80	16	1	22.0	16.3	6500	10000
	80	16	1	22.0	16.3	11000	13000
	80	16	1	22.0	16.3	6500	10000
	90	20	1.1	35.6	22.3	7100	8500
	90	20	1.1	35.6	22.3	7100	8500
	90	20	1.1	35.6	22.3	7100	8500
	90	20	1.1	35.6	22.3	7100	8500
	90	20	1.1	35.6	22.3	7100	8500

Designations	Abutment and fillet dimensions			Weight
	D _{smin}	dh _{max}	r _{amax}	
	mm			kg
6308/C9YA4	48	82	1.5	0.642
6408	49	101	2	1.20
62/41/HAP53	47.5	73.5	1	0.342
62/41/P53	47.5	73.5	1	0.353
61809	47	56	0.3	0.0391
16009	49	71	0.6	0.165
6009	50	70	1	0.246
6209	51.5	78.5	1	0.429
6209TN1	51.5	78.5	1	0.415
6209K	51.5	78.5	1	0.419
6209MA	51.5	78.5	1	0.492
6209/YA1	51.5	78.5	1	0.429
209	51.5	78.5	1	0.492
6609TN1/YA1	51.5	83.5	1	0.481
6309/YB5	53	92	1.5	0.850
6309/HAC3V2YA7	53	92	1.5	0.807
309U2	53	92	1.5	0.850
309HU	53	92	1.5	1.05
6309A	53	92	1.5	0.859
6309	53	92	1.5	0.850
6309TN1	53	92	1.5	0.809
6409	54	111	2	1.59
61910	53.2	68.8	0.6	0.128
16010	54	76	0.6	0.179
6010	55	75	1	0.255
FL-6010	55	75	1	0.255
FL-6010/P6	55	75	1	0.255
FL-6010-QD	55	75	1	0.255
6210/HA	56.5	83.5	1	0.504
6210/C9YA6	56.5	83.5	1	0.474
6210	56.5	83.5	1	0.474
FL-6210	56.5	83.5	1	0.474
FL-6210-QD	56.5	83.5	1	0.474

Deep Groove Ball Bearing

d 50-60 mm

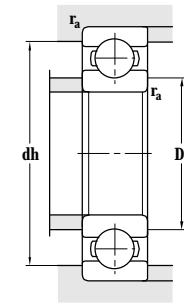
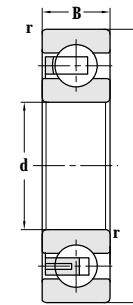
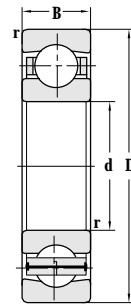
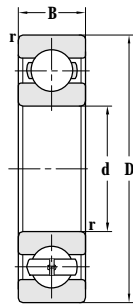

Principal dimensions				Basic load ratings		Limit speed ratings	
d	D	B	r _{min}	C _r	C _{or}	Grease	Oil
mm				kN		r/min	
50	90	26	1.1	35.6	22.3	7100	8500
	110	27	2	62.0	38.0	6300	7500
	110	27	2	62.0	38.0	6300	7500
	110	27	2	62.0	38.0	6300	7500
	110	27	2	62.0	38.0	6300	7500
	111	27	2.3	62.0	38.0	6300	7500
	111	27	2.3	62.0	38.0	6300	7500
	130	31	2.1	88.0	52.0	5300	6300
55	72	9	0.3	8.80	8.10	8500	10000
	80	13	1	15.9	13.2	8000	9500
	90	11	0.6	21.3	14.2	7500	9000
	90	18	1.1	29.0	20.7	7500	9000
	90	18	1.1	29.0	20.7	7500	9000
	90	11	0.6	18.6	15.2	7500	9000
	100	21	1.5	44.3	27.8	6300	7500
	100	21	1.5	44.3	27.8	6300	7500
	100	26	1.5	44.3	27.8	6300	7500
	120	29	2	71.5	45.0	5600	6700
	120	29	2	71.5	45.0	5600	6700
	120	29	2	71.5	45.0	5600	6700
	140	33	2.1	95.0	60.0	5000	6000
	60	85	13	1	17.0	15.1	7500
95		11	0.6	19.1	16.5	6700	8000
95		18	1.1	30.0	23.0	6700	8000
95		18	1.1	30.0	23.0	6700	8000
110		22	1.5	53.0	36.0	5600	7100
110		22	1.5	53.0	36.0	5600	7100
110		22	1.5	53.0	36.0	5600	7100
110		22	1.5	53.0	36.0	6000	7000
110		22	1.5	53.0	36.0	5600	7100
110		22	1.5	53.0	36.0	5600	7100
110		22	1.5	53.0	36.0	5600	7100
110		22	1.5	53.0	36.0	5600	7100
110		22	1.5	53.0	36.0	5600	7100

Designations	Abutment and fillet dimensions			Weight
	D _{smin}	dh _{max}	r _{amax}	
	mm			kg
62210X2	56.5	83.5	1	0.601
6310	59	101	2	1.12
6310A	59	101	2	1.12
6310TN1	59	101	2	1.06
6310TN11	59	101	2	1.06
6310X1	61	101	2	1.13
810	61	101	2	1.10
6410	61	119	2	1.91
61811	57	70	0.3	0.0845
61911	59.6	75.4	1	0.177
7000111	59	85	0.6	0.307
6011	61	84	1	0.384
6011/C9YA2	61	84	1	0.384
16011	58.2	86.8	0.6	0.255
6211K	63	92	1.5	0.620
6211	63	92	1.5	0.628
62211X2	63	92	1.5	0.759
6311	64	111	2	1.38
6311TN1	64	111	2	1.29
6311/YA6	64	111	2	1.37
6411	66	129	2	2.25
61912	64.5	80.5	1	0.201
16012	64	91	0.6	0.270
6012	66.5	88.5	1	0.416
6012M	66.5	88.5	1	0.497
6212	68	102	1.5	0.793
6212-1	68	102	1.5	0.772
6212/HAP63YA5	68	102	1.5	0.772
6212/YA6	68	102	1.5	0.793
212	68	102	1.5	0.793
212U	68	102	1.5	0.793
212U1	68	102	1.5	0.793
6212/YA5	68	102	1.5	0.772
6212K	68	102	1.5	0.781

Deep Groove Ball Bearing

d 60-70 mm

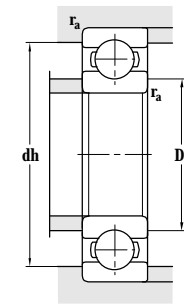
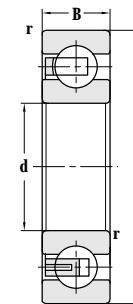
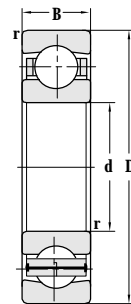
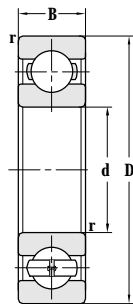

Principal dimensions				Basic load ratings		Limit speed ratings	
d	D	B	r _{min}	C _r	C _{or}	Grease	Oil
mm				kN		r/min	
60	130	31	2.1	82.0	50.0	5300	6300
	130	31	2.1	82.0	50.0	5300	6300
	130	31	2.1	82.0	50.0	5000	6000
	130	31	2.1	82.0	50.0	5000	6000
	130	31	2.1	82.0	50.0	5000	6000
	150	35	2.1	107	68.5	4800	5600
65	85	10	0.6	10.4	12.9	6700	8000
	90	13	1	19.9	17.5	6700	8000
	100	18	1.1	32.0	25.0	6300	7500
	100	18	1.1	32.0	25.0	6300	7500
	120	23	1.5	57.0	40.0	5300	6300
	120	23	1.5	57.0	40.0	5300	6300
	120	23	1.5	57.0	40.0	5300	6300
	120	23	1.5	57.0	40.0	5300	6300
	120	23	1.5	57.0	40.0	5300	6300
	120	23	1.5	57.0	40.0	5300	6300
	120	23	1.5	57.0	40.0	5300	6300
	140	33	2.1	95.0	59.5	4800	5600
	140	33	2.1	87.5	56.5	4800	5600
	140	33	2.1	92.5	59.5	4800	5600
	140	33	2.5	92.5	59.5	4800	5600
	140	33	2.1	92.5	59.5	4800	5600
160	37	2.1	118	78.5	4500	6300	
70	110	20	1.1	38.0	30.0	6000	7000
	110	20	1.1	38.0	30.0	6000	7000
	125	24	1.5	61.2	43.2	5000	6000
	125	24	1.5	61.2	43.2	5000	6000
	150	35	2.1	104	68.0	4500	5300
	150	35	2.1	104	68.0	4500	5300
	150	35	2.1	104	68.0	4500	5300
	150	35	2.1	107	68.0	4500	5300
	150	35	2.1	107	68.0	4500	5300
	150	35	2.1	107	68.0	4500	5300

Designations	Abutment and fillet dimensions			Weight
	D _{smin}	dh _{max}	ra _{max}	
	mm			kg
6312A	71	119	2	1.750
6312	71	119	2	1.750
6312Q1	71	119	2	2.12
6312TN1	71	119	2	1.69
4E312QT			2	2.07
6412	71	139	2	2.72
61813Q1	69	81	0.6	0.119
61913	70	85	1	0.195
6013	71.5	93.5	1	0.428
6013M	71.5	93.5	1	0.553
6213	73	112	1.5	1.00
FL-6213-QD	73	112	1.5	1.00
6213MA	73	112	1.5	1.23
6213A	73	112	1.5	1.00
6213/YA5	73	112	1.5	1.05
213G	73	112	1.5	1.01
180213	73	112	1.5	1.06
6313	76	129	2	2.10
6313/W124	77	128	2	2.15
6313A	76	129	2	1.85
6313/YA6	76	129	2.5	2.09
6313M	76	129	2	2.67
6413	76	149	2	3.21
6014	76.5	103.5	1	0.624
6014M	76.5	103.5	1	0.743
6214	78	117	1.5	1.12
6214A	78	117	1.5	1.12
6314A	81	139	2	2.60
6314/P6CMV2	81	139	2	2.55
314U1	81	139	2	2.55
6314	81	139	2	2.57
6314/W124	82	138	2	2.57
6314/C9	81	139	2	2.57

Deep Groove Ball Bearing

d 70-80 mm

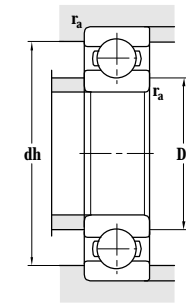
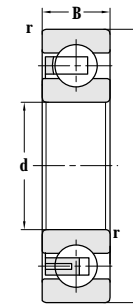
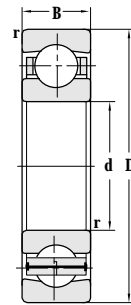
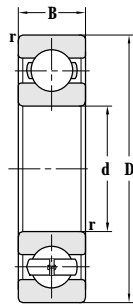

Principal dimensions				Basic load ratings		Limit speed ratings	
d	D	B	r _{min}	C _r	C _{or}	Grease	Oil
mm				kN		r/min	
70	150	35	2.1	107	68.0	4500	5300
	150	35	2.1	107	68.0	4500	5300
	180	42	3	136	100	3800	4500
72	110	20	1.1	38.0	31.0	5200	6500
	115	20	1.1	38.0	31.0	5600	6700
	115	20	1.1	38.0	31.0	5600	6700
75	105	16	1	26.5	23.5	5600	6700
	115	13	0.6	29.0	26.0	5600	6700
	115	13	0.6	29.0	26.0	5600	6700
	115	13	1.1	24.8	23.9	5600	6700
	130	25	1.5	66.0	50.0	4800	5600
	130	25	1.5	66.0	50.0	4800	5600
	130	25	1.5	66.0	50.0	4800	5600
	130	25	1.5	66.0	50.0	4800	5600
	130	31	1.5	66.0	50.0	4800	5600
	160	37	2.1	113	77	4300	5000
	160	37	2.1	113	77	4300	5000
	160	37	2.1	113	77	4300	5000
	160	37	2.1	113	77	4300	5000
	160	37	2.1	113	77	4300	5000
	160	37	2.1	113	77	4300	5000
190	45	3	146	107	3600	4300	
80	100	10	0.6	12.7	13.3	6000	7000
	110	16	1	27.5	25.0	5600	6700
	125	22	1.1	47.5	40.0	5300	6300
	125	22	1.1	47.5	40.0	6500	8000
	125	14	0.6	32.0	30.0	5300	6300
	125	22	1.1	47.5	40.0	5300	6300
	140	26	2	71.5	54.5	4500	5300
	140	26	2	71.5	54.5	4500	5300
	170	39	2.1	125	86.5	3800	4500
	170	39	2.1	125	86.5	3800	4500

Designations	Abutment and fillet dimensions			Weight
	D _{smin}	dh _{max}	ra _{max}	
	mm			kg
6314/YA6	81	139	2	2.58
6314TN1	81	139	2	2.50
6414	83	167	2.5	4.54
60/72	79.5	102.5	1	0.584
6015	81.5	108.5	1	0.630
6015M	81.5	108.5	1	0.804
61915	80	100	1	0.350
16015	81.5	108.5	0.6	0.546
16015M	81.5	108.5	0.6	0.546
16015/YA6	84.5	105.5	1	0.476
6215	83	122	1.5	1.21
6215A	83	122	1.5	1.21
6215M	83	122	1.5	1.46
6215K	83	122	1.5	1.18
62215	83	122	1.5	1.47
6315	86	149	2	3.03
6315A	86	149	2	3.03
6315/CM	86	149	2	3.02
315U1	86	149	2	3.02
6315/YA8	86	149	2	3.03
6315M	86	149	2	3.86
6415	88	177	2.5	5.88
61816	83.2	96.8	0.6	0.153
61916	85	105	1	0.350
6016	86.5	118.5	1	0.845
FL-6016/P6	86.5	118.5	1	0.845
16016	84	121	0.6	0.599
6016M	86.5	118.5	1	1.04
6216A	89	131	2	1.47
6216	89	131	2	1.47
6316	91	159	2	3.68
6316/CM	91	159	2	3.60

Deep Groove Ball Bearing

d 80-90 mm

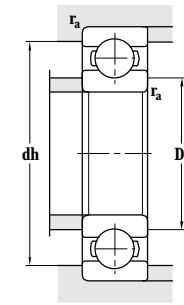
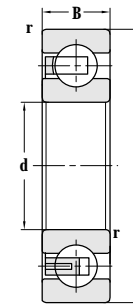
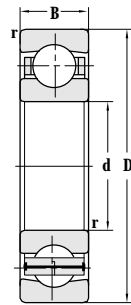
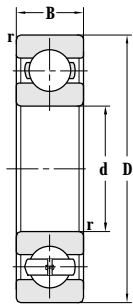

Principal dimensions				Basic load ratings		Limit speed ratings	
d	D	B	r _{min}	C _r	C _{or}	Grease	Oil
mm				kN		r/min	
80	170	39	2.1	125	86.5	3800	4500
	170	39	2.1	125	86.5	3800	4500
	200	48	3	160	122	3400	4000
85	120	18	1.1	30.3	27.0	5300	6300
	130	14	0.6	31.5	30.0	5000	6000
	130	22	1.1	47.5	40.0	5000	6000
	130	22	1.1	47.5	40.0	5000	6000
	150	28	2	84.0	62.0	4300	5000
	150	28	2	77.0	59.0	4300	5000
	150	28	2	84.0	62.0	4300	5000
	150	28	2	84.0	62.0	4300	5000
	150	28	2	84.0	62.0	4300	5000
	150	28	2	84.0	62.0	4300	5000
	150	28	2	77.0	59.0	4300	5000
	150	28	1	77.0	59.0	4300	5000
	180	41	3	102	96.5	3800	4500
	180	41	3	102	96.5	3800	4500
	180	41	3	102	96.5	3800	4500
	180	41	3	102	96.5	3600	4300
180	41	3	102	96.5	3800	4500	
210	52	4	170	132	3200	3800	
88.9	127	19.05	1.1	28.9	28.4	4400	5500
90	125	18	1.1	33.0	31.5	5000	6000
	125	18	1.1	33.0	31.5	5000	6000
	125	18	0.6	33.0	31.5	5000	6000
	140	24	1.5	58.5	50.0	4800	5600
	140	16	1	58.5	50.0	4800	5600
	140	24	1.5	58.5	50.0	4800	5600
	160	30	2	97.0	72.0	3800	4500
	160	30	2	73.5	72	3800	4500
	160	30	2	97.0	72.0	3800	4500
	190	43	3	144	108	3400	4000
	190	43	3	144	108	3400	4000

Designations	Abutment and fillet dimensions			Weight
	D _{smin}	dh _{max}	r _{amax}	
	mm			kg
6316M/HQ1	91	159	2	4.54
6316A	91	159	2	3.68
6416	93	187	2.5	6.84
61917	91	114	1	0.557
16017	89	126	0.6	0.636
6017	91.5	123.5	1	0.935
6017M	91.5	123.5	1	1.12
6217	94	141	2	1.85
6217/W124	94	141	2	1.85
6217K	94	141	2	1.81
6217A	94	141	2	1.85
6217/HA	94	141	2	1.80
6217M	94	141	2	1.91
6217/CRA9W124	94	141	2	1.85
6217R/C3Z1YA6	94	141	1	1.95
6317	98	167	2.5	4.33
6317/P6CMV2	98	167	2.5	4.33
6317M	98	167	2.5	4.97
6317/CRA9W124	99	166	2.5	4.29
317U1	98	167	2.5	4.33
6417	101	194	3	8.10
66/88.9/YA2	96.4	120.5	1	0.690
61918	96.5	118.5	1	0.572
61918M	96.5	118.5	1	0.680
61918/YA6	96.5	118.5	0.5	0.572
6018	98	132	1.5	1.15
16018M	95	135	1	0.990
6018M	98	132	1.5	1.36
6218	99	151	2	2.19
6218/CRA9W124	101	149	2	2.19
218U1	99	151	2	2.19
6318	103	177	2.5	4.97
6318/CM	103	177	2.5	4.97

Deep Groove Ball Bearing

d 90-100 mm

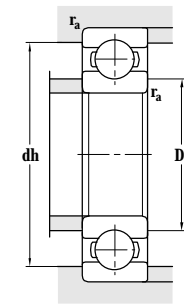
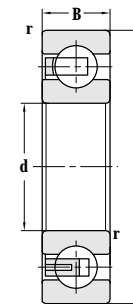
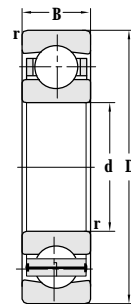
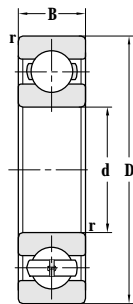

Principal dimensions				Basic load ratings		Limit speed ratings	
d	D	B	r _{min}	C _r	C _{or}	Grease	Oil
mm				kN		r/min	
90	190	43	3	144	108	3400	4000
	190	43	5.5	144	108	3400	4000
	225	54	4	189	154	3000	3600
95	120	13	1	19.3	20.4	5000	6000
	130	18	1.1	33.8	33.0	4800	5600
	145	16	1	40.5	39.0	4500	5300
	145	24	1.5	78.5	54.0	4500	5300
	170	32	2.1	110	80.0	3600	4300
	170	32	2.1	102	77.0	3600	4300
	170	32	2.1	110	80.0	3600	4300
	170	32	2.1	102	77.0	3600	4300
	200	45	3	152	118	3200	3800
	200	45	3	152	118	3200	3800
	200	45	3	152	118	3200	3800
	200	45	3	152	118	3200	3800
	200	45	3	152	118	3200	3800
	200	45	3	152	118	3200	3800
	240	55	4	195	162	3400	3600
100	125	13	1	19.6	21.2	4800	5600
	140	20	1.1	34.5	35.0	4500	5300
	140	20	1.1	34.5	35.0	4500	5300
	150	16	1	43.6	44.0	4300	5000
	150	24	1.5	62.4	52.9	4300	5000
	150	24	1.5	62.4	52.9	4300	5000
	180	28	1.8	116	92.0	3400	4000
	180	34	2.1	122	93.0	3400	4000
	180	34	2.1	115	88.0	3400	4000
	180	34	2.1	115	88.0	3400	4000
	215	47	3	173	141	2800	3600
	215	47	3	173	141	2800	3600
	215	47	3	173	141	2800	3600
	215	47	3	173	141	3000	3600

Designations	Abutment and fillet dimensions			Weight
	D _{smin}	dh _{max}	r _{amax}	
	mm			kg
6318M/C4	103	177	2.5	6.37
6318/YA6	103	177	2.5	4.97
6418	106	209	3	9.58
61819	99.6	115	1	0.288
61919	101	124	1	0.610
16019	100	140	1	0.884
6019	103	137	1.5	1.14
6219	106	159	2	2.66
6219/W124	106	159	2	2.66
6219M	106	159	2	3.34
6219/CRA9W124	106	159	2	2.66
6319	108	187	2.5	5.84
IS-6319M	108	187	2.5	7.11
6319/CM	108	187	2.5	5.58
6319A	108	187	2.5	5.84
6319-DT	108	187	2.5	5.84
6319F1/HQ1	108	187	2.5	6.93
6319M/HQ1	108	187	2.5	7.11
IS-6319	109	186	2.5	5.48
6419M	108	215	2.5	13.6
61820	105	120	1	0.326
61920M	106.5	133.5	1	0.960
61920	106.5	133.5	1	0.850
16020	108	142	1	0.916
6020	108	142	1.5	1.15
6020M	108	142	1.5	1.37
720	111.5	171.5	1.8	2.70
6220	111	169	2	3.25
6220/CRA9W124	111	169	2	3.25
6220/W124	111	169	2	3.25
6320	113	202	2.5	7.10
IS-6320M	113	202	2.5	8.94
6320-DT	113	202	2.5	7.10
6320/W124	114	201	2.5	7.10

Deep Groove Ball Bearing

d 100~110 mm

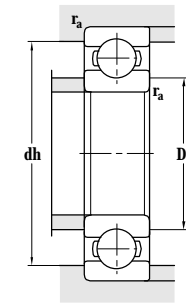
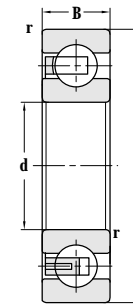
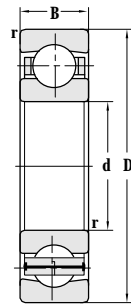
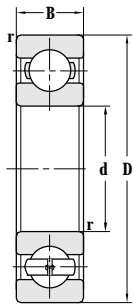

Principal dimensions				Basic load ratings		Limit speed ratings		
d	D	B	r _{min}	C _r	C _{or}	Grease	Oil	
mm				kN		r/min		
100	215	47	3	173	141	2800	3600	
	215	47	3	173	141	2800	3600	
	215	47	3	173	141	2800	3600	
	215	47	3	173	141	2800	3600	
	215	47	3	173	141	3000	3600	
	215	47	3	173	141	3000	3600	
	215	47	3	173	141	2800	3600	
	250	58	4	214	184	2600	3400	
	250	58	4	214	184	2600	3400	
	105	130	13	1	19.9	21.9	4500	5300
160		26	2	73.0	62.8	4000	4800	
160		26	2	73.0	62.8	4000	4800	
160		26	2	73.0	62.8	4000	4800	
180		22	1.1	68.0	65.0	4200	5000	
180		22	1.1	61.5	59.5	4200	5000	
190		36	2.1	135	102	3200	3800	
190		36	2.1	133	105	3200	3800	
190		36	2.1	133	105	3200	3800	
190		36	2.1	135	102	3200	3800	
225		49	3	240	154	2800	3400	
110		140	16	1	24.8	28.0	4300	5000
		150	20	1.1	43.5	44.5	4000	4800
	150	20	1.1	43.5	44.5	4000	4800	
	170	19	1	57.2	57.0	3800	4500	
	170	28	2	82.0	70.6	3800	4500	
	170	28	2	82.0	70.6	3800	4500	
	170	28	2	82.0	70.6	3800	4500	
	200	38	2.1	145	114	2800	3400	
	200	38	2.1	145	114	2800	3400	
	200	38	2.1	132	106	3000	3600	
	240	50	3	195	167	2400	3000	
	240	50	3	195	167	2400	3000	
	240	50	3	195	167	2600	3200	
	240	50	3	151	169	2400	3000	

Designations	Abutment and fillet dimensions			Weight
	D _{smin}	dh _{max}	r _{amax}	
	mm			kg
6320A	113	202	2.5	7.10
6320M	113	202	2.5	8.94
6320M-DT	113	202	2.5	8.34
6320MA	113	202	2.5	9.28
6320M/CRA9	114	201	2.5	8.94
6320M/HQ1	114	201	2.5	8.00
6320/YA8	113	202	2.5	7.20
6420	116	234	3	13.1
6420M	116	234	3	16.2
61821M	110	125	1	0.468
6021	114	151	2	1.65
6021A	114	151	2	1.65
6021M	114	151	2	1.94
721	113.5	173.5	1	2.61
60121X1M	113.5	173.5	1	2.55
6221	116	179	2	3.85
6221/W124	117	178	2	3.66
6221/CRA9W124	117	178	2	3.66
6221M/CRA9	117	178	2	4.66
6321	118	212	2.5	8.05
61822	115	135	1	0.505
61922	116.5	143.5	1	0.888
61922M	116.5	143.5	1	1.01
16022	115	165	1	1.48
6022	119	161	2	1.92
6022M	119	161	2	2.35
6022M/YB5	119	161	2	2.35
6222	121	189	2	4.55
6222M	121	189	2	5.46
6222M/CRA9	122	188	2	5.46
6322	123	227	2.5	9.72
IS-6322M	123	227	2.5	11.7
6322-DT	123	227	2.5	9.72
6322/CM	123	227	2.5	9.23

Deep Groove Ball Bearing

d 110~130 mm

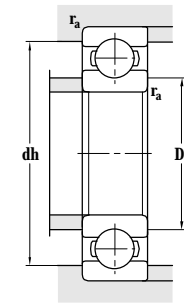
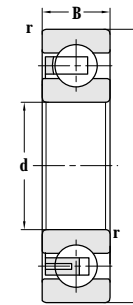
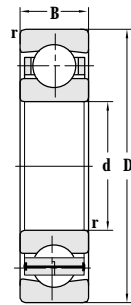
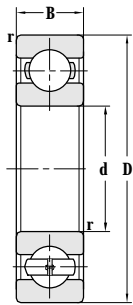

Principal dimensions				Basic load ratings		Limit speed ratings	
d	D	B	r _{min}	C _r	C _{or}	Grease	Oil
mm				kN		r/min	
110	240	50	3	195	167	2600	3200
	240	50	3	195	167	2600	3200
	240	50	3	205	176	2400	3000
	240	50	3	205	176	2400	3000
	240	50	3	195	167	2600	3200
	280	65	4	247	226	2200	3000
	280	65	4	247	226	2200	3000
120	150	16	1	24.5	28.0	3800	4500
	165	22	1.1	53.0	54.0	3600	4300
	165	22	1.1	53.0	54.0	3600	4300
	180	19	1	60.5	64.0	3400	4000
	180	19	1	60.5	64.0	3400	4000
	180	28	2	85.5	80.0	3400	4000
	180	28	2	85.5	80.0	3400	4000
	180	28	2	85.5	80.0	3400	4000
	215	40	2.1	154	130	2800	3400
	215	40	2.1	155	132	2800	3400
	215	40	2.1	154	130	2800	3400
	215	40	2.1	155	132	2800	3400
	260	55	3	217	196	2200	2800
	260	55	3	217	196	2200	2800
	260	55	3	217	196	2200	2800
	260	55	3	217	196	2200	2800
	260	55	3	217	196	2200	2800
	260	55	3	217	196	2200	2800
	260	55	3	217	196	2400	3000
	120.65	165.1	22.225	1.1	53.3	54.0	3600
121	165	22	1.1	53.3	54.0	3600	4300
127	228.6	34.925	2	148	133	2200	2800
130	165	18	1.1	37.0	38.0	3600	4300
	180	24	1.5	65.0	67.0	3400	4000

Designations	Abutment and fillet dimensions			Weight
	D _{smin}	dh _{max}	r _{amax}	
	mm			kg
6322/W124	124	226	2.5	9.72
IS-6322M	124	226	2.5	11.7
6322A	123	227	2.5	9.72
6322M	123	227	2.5	11.7
6322M/HQ1	124	226	2.5	10.5
6422	126	264	3	18.3
6422M	126	264	3	19.0
61824	125	145	1	0.566
61924	126.5	158.5	1	1.21
61924M	126.5	158.5	1	1.54
16024	125	175	1	1.64
16024M	125	175	1	1.82
6024	129	171	2	2.09
6024A	129	171	2	2.09
6024M	129	171	2	2.68
6224	131	204	2	5.28
6224/W124	132	203	2	5.30
6224M	131	204	2	6.68
6224M/CRA9	132	203	2	6.63
6324	133	247	2.5	12.5
6324-DT	133	247	2.5	12.5
6324A	133	247	2.5	12.5
6324M/C3	133	247	2.5	13.7
6324M-DT	133	247	2.5	14.8
6324F1/HQ1	133	247	2.5	13.4
6324/W124	134	245	2.5	12.5
619/121X4M	126.5	158.5	1	1.48
619/121M	126.5	158.5	1	1.48
66/127M	136	219.6	2	7.00
61826MA	136	159	1	0.969
61926M	138	172	1.5	1.92

Deep Groove Ball Bearing

d 130~140 mm

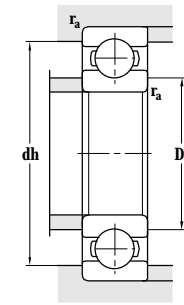
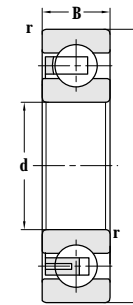
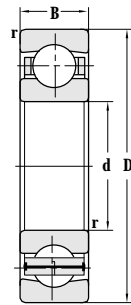
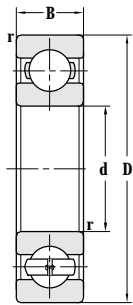

Principal dimensions				Basic load ratings		Limit speed ratings	
d	D	B	r _{min}	C _r	C _{or}	Grease	Oil
mm				kN		r/min	
130	180	24	1.5	65.0	67.0	3400	4000
	190	19	0.7	56.0	60.0	3200	3800
	190	19	0.7	56.0	60.0	3200	3800
	200	22	1.1	79.5	81.5	3200	3800
	200	22	1.1	79.5	81.5	3200	3800
	200	33	2	109	98	3200	3800
	200	33	2	109	98	3200	3800
	200	33	2	109	98	3200	3800
	200	33	2	109	98	3200	3800
	230	40	3	153	134	2600	3200
	230	40	3	153	134	2600	3200
	230	40	3	153	134	2600	3200
	230	40	3	165	148	2600	3200
	230	40	3	165	148	2600	3200
	230	40	3	153	134	2600	3200
	280	58	4	251	241	2200	2600
	280	58	4	230	216	2200	2600
	280	58	4	240	226	2200	2800
	280	58	4	251	241	2200	2600
	280	58	4	251	241	2200	2600
280	58	4	251	241	2200	2600	
280	58	4	251	241	2200	2600	
280	58	4	251	241	2200	2600	
280	58	4	230	216	2200	2600	
140	175	18	1.1	37.0	40.0	3400	4000
	175	18	1.1	37.0	40.0	3400	4000
	190	24	1.5	64.0	67.5	3200	3800
	210	22	1.1	80.5	86.5	3000	3600
	210	33	2	106	102	3000	3600
	210	33	2	106	102	3000	3600
	210	33	2	106	102	3000	3600
	210	33	2	106	102	3000	3600
	250	42	3	166	150	2400	3000
	250	42	3	166	150	2400	3000
	250	42	3	166	150	2400	3000
	250	42	3	166	150	2400	3000
	250	42	3	128	150	2400	3000

Designations	Abutment and fillet dimensions			Weight
	D _{smin}	dh _{max}	r _{amax}	
	mm			kg
61926	138	172	1.5	1.56
726	134	186	0.7	1.70
726H	134	186	0.7	1.91
16026M	136.5	193.5	1	2.32
16026	136.5	193.5	1	2.19
6026	139	191	2	3.29
FL-6026	139	191	2	3.29
6026M	139	191	2	3.96
6026MA	139	191	2	3.98
6226	143	217	2.5	6.33
6226M/CRA9	144	216	2.5	7.83
6226/W124	144	216	2.5	6.33
226HU1	143	217	2.5	7.51
226U1	143	217	2.5	6.16
6226MA	143	217	2.5	7.91
6326	146	264	3	15.3
6326-DT	146	264	3	15.1
6326/W124	147	263	3	15.3
6326A	146	264	3	14.9
6326F1/HQ1	146	264	3	16.7
FL-6326/HQ1	146	264	3	13.5
6326M	146	264	3	18.3
6326M-DT	146	264	3	17.6
61828M	146.5	168.5	1	1.00
61828MA	146.5	168.5	1	0.933
61928M	148	182	1.5	2.11
16028M	146.5	203.5	1	3.08
6028	146.5	201	2	3.47
6028/C9	149	201	2	3.47
6028/C9YB2	149	201	2	3.47
6028M	149	201	2	4.20
6228	153	237	2.5	7.41
6228/W124	154	236	2.5	7.41
6228M	153	237	2.5	9.28
6228MA	153	237	2.5	9.50

Deep Groove Ball Bearing

d 140~150 mm

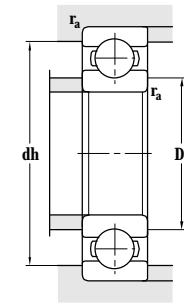
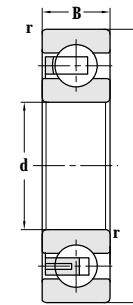
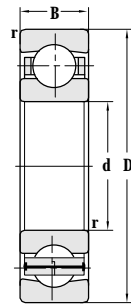
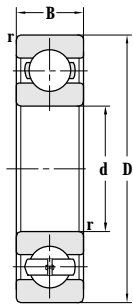

Principal dimensions				Basic load ratings		Limit speed ratings	
d	D	B	r _{min}	C _r	C _{or}	Grease	Oil
mm				kN		r/min	
140	250	42	3	166	150	2400	3000
	300	62	4	329	246	2000	2600
	300	62	4	329	246	2000	2600
	300	62	4	253	246	2000	2600
	300	62	4	253	246	2000	2600
	300	62	4	329	246	2000	2600
	300	62	4	253	246	2000	2600
	300	62	4	253	246	2000	2600
	300	62	4	253	246	2000	2600
144	185	22	0.7	62.5	70.0	3600	4000
	185	22	0.7	48.0	70.0	3600	4000
149	201	33	0.7	105	102	3000	3600
	201	33	0.7	81.0	100	3000	3600
150	190	20	1.1	46.4	53.0	3000	3600
	210	28	2	84.5	90	2800	3400
	225	24	1.1	89.0	96.0	2600	3200
	225	24	1.1	89.0	96.0	2600	3200
	225	35	2.1	123	117	2600	3200
	225	35	2.1	123	117	2600	3200
	225	35	2.1	123	117	2600	3200
	225	35	2.1	123	117	2600	3200
	225	35	2.1	123	117	2600	3200
	225	35	2.1	123	117	2600	3200
	230	35	2.1	123	117	2500	3000
	270	45	3	189	183	2000	2600
	270	45	3	189	183	2000	2600
	270	45	3	176	169	2000	2600
	270	45	3	176	169	2000	2600
	270	45	3	176	169	2000	2600
	320	65	4	360	280	1800	2200
	320	65	4	360	280	1800	2200
	320	65	4	360	280	1800	2200
	320	65	4	277	280	1800	2200
	320	65	4	360	280	1800	2200

Designations	Abutment and fillet dimensions			Weight
	D _{smin}	dh _{max}	r _{amax}	
	mm			kg
6228M/CRA9	154	236	2.5	9.28
6328	156	284	3	18.8
FL-6328/HQ1	156	284	3	16.7
6328-DT	156	284	3	18.8
6328L3-DT	156	284	3	20.7
6328/W124	157	283	3	18.8
6328M	156	284	3	21.5
6328M-DT	156	284	3	22.7
6328M/CRA9	157	283	3	21.5
928T3	148	181	0.7	1.07
66/144/S2	148	181	0.7	1.07
930T3	153	197	0.7	1.79
66/149/S2	153	197	0.7	1.79
61830M	156	184	1	1.50
61930M	159	201	2	3.04
16030	156.5	218.5	1	3.14
16030M	156.5	218.5	1	3.67
6030	161	214	2	4.07
FL-6030	161	214	2	4.07
6030/C9	161	214	2	4.07
6030M	161	214	2	4.98
6030M/P4	161	214	2	4.98
6030X1M	159	220	2.1	5.37
6230	163	257	2.5	9.96
6230/W124	164	256	2.5	9.96
6230M	163	257	2.5	11.4
6230M/W124	164	256	2.5	11.8
6230M/CRA9	164	256	2.5	11.4
6330	166	304	3	22.2
IS-6330	166	304	3	22.2
FL-6330/HQ1	166	304	3	18.3
6330-DT	166	304	3	22.2
IS-6330	166	304	3	22.2

Deep Groove Ball Bearing

d 150~170 mm

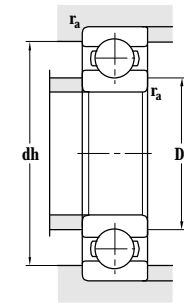
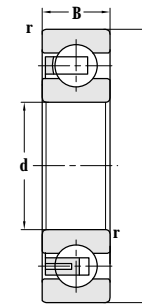
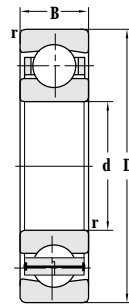
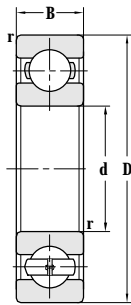

Principal dimensions				Basic load ratings		Limit speed ratings	
d	D	B	r _{min}	C _r	C _{or}	Grease	Oil
mm				kN		r/min	
150	320	65	4	277	280	1800	2200
	320	65	4	277	280	1900	2400
160	200	20	1.1	49.5	59	2600	3200
	220	28	2	89	90.0	2600	3200
	229.5	33	3	108	111	2500	3100
	240	25	1.5	94.0	104	2400	3000
	240	25	1.5	94.0	104	2400	3000
	240	38	2.1	143	138	2400	3000
	240	38	2.1	143	138	2400	3000
	240	38	2.1	143	138	2400	3000
	240	38	2.1	127	127	2400	3000
	290	48	3	210	210	1900	2400
	290	48	3	200	201	1900	2400
	290	48	3	202	201	1900	2400
	290	48	3	200	201	1900	2400
	290	48	3	200	201	1900	2400
	290	48	3	202	202	1900	2400
	340	68	4	310	325	1800	2200
	340	68	4	310	325	1800	2200
	340	68	4	310	325	1800	2200
340	68	4	310	325	1800	2200	
340	68	4	238	325	1800	2200	
340	68	4	310	325	1800	2200	
165	250.5	35	2.5	147	143	2200	2600
170	215	22	1.1	65.0	61.0	2600	3200
	215	22	1.1	65.0	61.0	2600	3200
	215	22	1.1	65.0	61.0	2600	3200
	230	28	2	115	100	2400	3000
	230	28	2	115	100	2400	3000
	260	28	1.5	119	128	2200	2800
	260	28	1.5	119	129	2200	2800
	260	42	2.1	161	166	2200	2800
	260	42	2.1	161	166	2200	2800

Designations	Abutment and fillet dimensions			Weight
	D _{smin}	dh _{max}	r _{amax}	
	mm			kg
6330M	166	304	3	23.9
6330M/W124	167	303	3	26.0
61832M	168	192	1.1	1.32
61932M	169	211	2	3.28
62932X3M/YA6	168	211	3	4.67
16032	168	232	1.5	3.95
16032M	168	232	1.5	4.60
6032	171	229	2	5.04
6032/C9	171	229	2	5.04
6032M	171	229	2	6.04
6032M/W124	169	231	2	6.04
6232	173	277	2.5	12.4
6232-DT	173	277	2.5	12.3
6232M	173	277	2.5	14.2
6232M/P59Z2	174	276	2.5	14.4
6232M/CRA9	174	276	2.5	14.2
6232/W124	174	276	2.5	12.3
6332	177	323	3	25.7
6332-DT	177	323	3	26.5
6332M	176	324	3	30.7
6332M-DT	176	324	3	31.8
6332M/W124	177	323	3	30.5
6332/W124	176	324	3	25.7
733	177	238	2.5	6.44
61834M	176.5	208.5	1	2.03
61834M-Z/YA8	176.5	208.5	1	1.89
61834MA	176.5	208.5	1	1.98
61934M	179	221	2	3.42
61934MA	179	221	2	3.40
16034	178	252	1.5	5.01
16034M	178	252	1.5	5.83
6034M	181	249	2	7.96
6034MA	181	249	2	8.25

Deep Groove Ball Bearing

d 170~190 mm

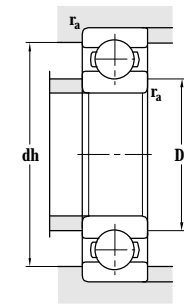
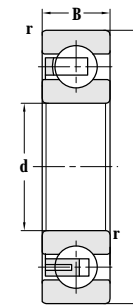
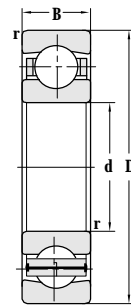
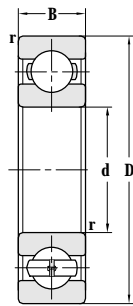

Principal dimensions				Basic load ratings		Limit speed ratings		
d	D	B	r _{min}	C _r	C _{or}	Grease	Oil	
mm				kN		r/min		
170	260	42	2.1	161	166	2200	2800	
	260	42	2.1	161	166	2200	2800	
	260	42	2.1	170	171	5300	4300	
	310	52	4	225	240	1900	2400	
	310	52	4	225	240	1900	2400	
	310	52	4	225	240	1900	2400	
	310	52	4	242	256	1900	2400	
	310	52	4	225	240	1900	2400	
	360	72	4	330	368	1700	2000	
	360	72	4	330	368	1700	2000	
	360	72	4	330	368	1700	2000	
	360	72	4	330	368	1700	2000	
	360	72	4	330	368	1700	2000	
	180	225	22	1.1	61.8	79.0	2400	3000
225		22	1.1	61.8	79.0	2400	3000	
250		33	2	118	128	2200	2800	
259.5		33	2	118	128	2200	2800	
259.5		52	2	118	128	2200	2800	
259.5		52	2	140	147	2200	2800	
280		31	2	135	145	2100	2700	
280		46	2.1	186	196	2200	2600	
280		46	2.1	186	196	2200	2600	
320		52	4	240	260	1800	2200	
320		52	4	240	260	1800	2200	
320		52	4	240	260	1800	2600	
380		75	4	340	400	1700	1900	
190		240	24	1.5	73.0	94.0	2200	2800
		260	33	2	127	138	2200	2800
		269.5	33	2	127	138	2200	2800
	289.5	46	2.1	191	211	2000	2600	
	290	31	2	145	162	2000	2600	
	290	31	2	145	162	2000	2600	
	290	46	2.1	191	211	2000	2600	
	290	46	2.1	191	211	2000	2600	

Designations	Abutment and fillet dimensions			Weight
	D _{smin}	dh _{max}	r _{amax}	
	mm			kg
6034	181	249	2	6.86
6034Q1	181	249	2	8.06
4G134QT	181	249	2	7.94
6234	186	294	3	15.1
6234-DT	186	294	3	15.1
6234M	186	294	3	17.9
6234/YA5	186	294	3	15.2
6234M/CRA9	187	293	3	17.9
6334	186	344	3	31.5
6334-DT	186	344	3	31.5
6334M	186	344	3	38.4
6334M/W124	187	343	3	38.4
6334M/P59Z2	187	343	3	38.4
61836M	186	219	1	2.05
61836MA	186	219	1	2.17
61936M	189	241	2	5.07
61936X1M	189	241	2	6.05
63936X1M	189	250.5	2	8.64
63936X1F3-1/C3H	189	250.5	2	8.82
16036M	189	270	2	6.58
6036	191	269	2	8.75
6036M	191	269	2	10.4
6236	196	304	3	14.9
6236M	196	304	3	17.8
6236MA	196	304	3	18.7
6336M	198	363	3	49.5
61838M	198	232	1.5	2.63
61938M	199	251	2	5.85
61938X1M	199	260.5	2	5.78
6038X1M	201	279	2	10.8
16038	199	281	2	6.88
16038M	199	281	2	8.11
6038M	201	279	2	11.1
6038	201	279	2	9.58

Deep Groove Ball Bearing

d 190~230 mm

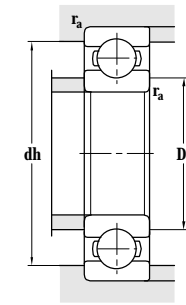
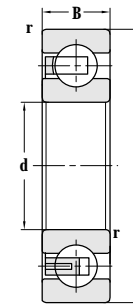
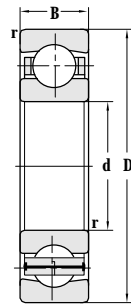
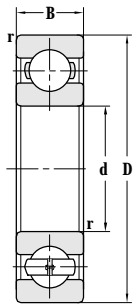

Principal dimensions				Basic load ratings		Limit speed ratings		
d	D	B	r _{min}	C _r	C _{or}	Grease	Oil	
mm				kN		r/min		
190	340	55	4	265	305	1700	2000	
	340	55	4	265	305	1700	2000	
	340	55	4	265	305	1700	2000	
	340	55	4	265	305	1700	2000	
	400	78	5	370	440	1600	1900	
	400	78	5	360	425	1600	1900	
200	250	24	1.5	73.0	84.0	2200	2800	
	250	24	1.5	73.0	84.0	2200	2800	
	269.5	51	2.1	130	146	1900	2300	
	269.5	51	2.1	91.0	109	1900	2300	
	279.5	38	2.1	125	144	2000	2600	
	280	38	2.1	125	144	2000	2600	
	289.5	38	2.1	125	144	2000	2600	
	310	34	2	162	182	1900	2400	
	310	51	2.1	213	234	1900	2400	
	310	51	2.1	213	234	1900	2400	
	310	51	2.1	213	234	1900	2400	
	360	58	4	285	335	1700	2000	
	360	58	4	268	305	1700	2000	
	420	80	5	380	460	1600	1800	
220	270	24	1.5	75.0	89.0	1900	2400	
	270	24	1.5	75.0	89.0	1900	2400	
	300	38	2.1	148	176	1900	2400	
	300	60	2.1	112	168	1900	2400	
	309.5	38	2.1	148	176	1900	2400	
	340	37	2.1	170	215	1800	2200	
	340	56	3	242	284	1800	2200	
	340	56	3	242	284	1800	2200	
	400	65	4	297	365	1500	1800	
	400	65	4	229	365	1500	1800	
	460	88	5	403	520	1300	1600	
	460	88	5	403	520	1300	1600	
	230	329.5	40	2.1	190	227	1600	2000

Designations	Abutment and fillet dimensions			Weight
	D _{smin}	dh _{max}	r _{amax}	
	mm			kg
6238	206	324	3	18.1
6238M	206	324	3	22.2
6238M-DT	206	324	3	21.1
6238M/CRA9	207	323	3	22.2
6338F3	210	382	4	48.4
6338M	210	382	4	50.0
61840MA	207	243	1.5	2.94
61840MA/P4	207	243	1.5	2.94
61040X1F3/C3H	208	260	2	7.91
61040X1M	208	260	2	8.10
61940X1MA-1	210	270	2	7.59
61940MA	210	270	2	7.63
61940X1MA	210	270	2	8.89
16040M	209	301	2	10.3
6040M	211	299	2	14.2
6040MA	210	300	2	14.3
6040	211	299	2	11.7
6240	216	344	3	22.3
6240M	216	344	3	26.4
6340	220	400	4	57.7
61844M	227	263	1.5	3.21
61844M/YA4	227	263	1.5	3.21
61944M	231	289	2	8.37
63944M	231	289	2	11.8
61944X1M	231	298.5	2	9.71
16044	233	327	2	11.7
6044	233	327	2.5	15.5
6044M	233	327	2.5	18.3
6244	236	384	3	31.2
6244M	236	384	3	36.3
6344	240	440	4	71.4
6344/C9	240	440	4	71.4
6646M	241	319	2.1	10.4

Deep Groove Ball Bearing

d 230~280 mm

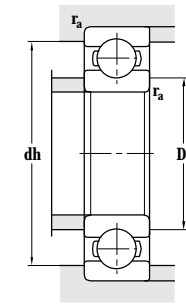
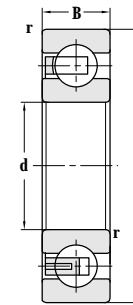
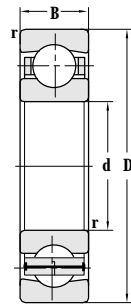
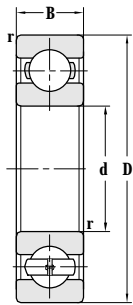

Principal dimensions				Basic load ratings		Limit speed ratings	
d	D	B	r _{min}	C _r	C _{or}	Grease	Oil
mm				kN		r/min	
230	309.5	40	2.1	145	173	1600	2000
	329.5	40	2.1	190	227	1600	2000
240	300	28	2	103	116	1800	2200
	320	38	2.1	155	192	1800	2200
	359.5	56	3	255	315	1700	2000
	360	37	2.1	185	228	1700	2000
	360	56	3	255	315	1700	2000
	360	56	3	255	315	1700	2000
	440	72	4	350	460	1300	1600
	500	95	5	440	595	1100	1400
	500	95	5	440	595	1100	1400
	500	95	5	440	595	1100	1400
	260	320	28	2	122	128	1700
360		46	2.1	212	269	1600	1900
360		46	2.1	212	269	1600	1900
369.5		46	2.1	212	269	1600	1900
369.5		68	2.1	227	288	1600	1900
369.5		60	2.1	227	288	1600	1900
369.5		60	2.1	227	288	1600	1900
399.5		65	4	294	373	1500	1800
370		46	2.1	212	269	1600	1900
400		44	3	230	300	1500	1800
400		65	4	294	373	1500	1800
400		65	4	294	373	1500	1800
480		80	5	430	592	1100	1400
480		80	5	430	592	1100	1400
480		80	5	430	592	1100	1400
540		102	6	500	710	1000	1300
540		102	6	500	710	1000	1300
280	350	33	2	133	192	1600	1900
	380	46	2.1	215	282	1500	1800
	389.5	46	4	215	282	1500	1800
	389.5	46	4	217	282	1500	1800
	389.5	46	4	217	282	1500	1800

Designations	Abutment and fillet dimensions			Weight
	D _{smin}	dh _{max}	r _{amax}	
	mm			kg
6646M-1/C3	241	319	2.1	9.02
6646M/W281	241	319	2.1	10.4
61848M	249	291	2	4.72
61948M	251	309	2	8.50
6048X1M	253	346.5	2.5	20.7
16048M	253	347	2	14.6
6048	253	347	2.5	17.6
6048M	253	347	2.5	20.7
6248	256	424	3	53.3
6348F1	260	480	4	95.0
6348F3	260	480	4	95.0
6348M	260	480	4	96.2
61852M	269	311	2	4.80
61952M	276	349	2	14.4
61952MA	271	349	2	14.4
61952X1M	276	349	2	16.3
62952X3M	271	358.5	2	22.9
62952X1M-1	271	358.5	2	20.3
62952X1F3-2/C3H	271	358.5	2	20.9
6052X1F3	276	384	3	28.5
752	271	359	2	16.5
16052M	272	388	2.5	22.3
6052M	276	384	3	28.4
6052M/YA3	276	384	3	26.6
6252/C3	280	460	4	68.8
6252F1	280	460	4	67.6
6252F3	280	460	4	67.6
6352F1	286	514	5	120
6352F3	286	514	5	120
61856M	289	341	2	7.30
61956M	291	369	2	16.4
61956X1M	291	379	2	18.3
61956X1M/W281	291	379	2	18.3

Deep Groove Ball Bearing

d 280~360 mm

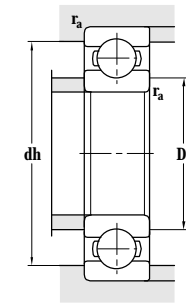
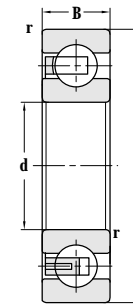
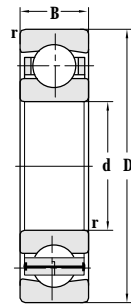
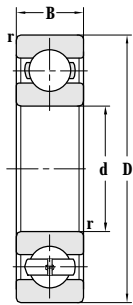

Principal dimensions				Basic load ratings		Limit speed ratings	
d	D	B	r _{min}	C _r	C _{or}	Grease	Oil
mm				kN		r/min	
280	390	46	4	215	282	1500	1800
	420	44	3	235	330	1300	1600
	420	65	4	305	405	1400	1700
	500	80	5	410	600	1000	1300
	580	108	6	560	840	1000	1200
300	380	38	2.1	165	235	1400	1700
	419.5	56	3	265	370	1400	1700
	420	56	3	265	370	1300	1600
	460	50	4	289	400	1200	1500
	460	74	4	343	480	1200	1500
	460	68	4	343	480	1200	1500
	540	85	5	450	665	950	1200
320	400	38	2.1	164	220	1300	1600
	400	38	2.1	164	220	1300	1600
	412	38	2.5	180	292	1300	1600
	440	37	2.1	210	305	1200	1400
	440	56	3	278	395	1300	1600
	440	65	3	278	395	1300	1600
	460	70	3	300	440	1300	1600
	479.5	74	4	356	518	1100	1400
	480	50	4	275	400	1100	1300
	480	74	4	356	518	1100	1400
	480	74	4	356	518	1100	1400
	560	82	5	435	665	950	1200
	580	92	5	515	780	1000	1200
340	420	38	2.1	170	227	1200	1500
	460	56	3	282	420	1100	1400
	460	56	3	282	420	1100	1400
	520	57	4	335	510	950	1200
	520	82	5	403	620	1000	1300
	620	92	6	545	890	900	1000
	360	440	25	1.5	118	210	1130

Designations	Abutment and fillet dimensions			Weight
	D _{smin}	dh _{max}	r _{amax}	
	mm			kg
61956X1M-1	291	379	2	18.4
16056	292	407	2.5	22.5
6056	296	404	3	32.2
6256	300	480	4	72
6356	305	553	5	141
61860M	309	371	2	10.4
61960X1	313	406.5	2.5	20.6
61960	313	407	2.5	20.7
16060/HA	316	444	3	33.1
6060	316	444	3	48.4
6060X2F3	316	444	3	41.5
6260	320	520	4	88.0
61864M	331	389	2	11.4
61864F3	331	389	2	11.1
864	332	400	2.5	12.7
60964	331	428	2	15.5
61964	333	427	2.5	24.9
61964X2	333	427	2.5	28.4
62964X3/YB2	333	447	2.5	39.9
6064X1	336	464	3	50.1
16064	336	466	3	34
6064	336	464	3	50.3
6064/C4YA8	336	464	3	49.6
6076N1F3	400	540	4	65.6
6264	340	560	4	111
61868	352	408	2	11.6
61968	353	447	2.5	27.0
61968MA	353	447	2.5	27.6
16068	356	505	3	44.9
6068	360	500	4	63.4
6268	366	599	4	112
60872	367	432	1.5	6.50

Deep Groove Ball Bearing

d 360~400 mm

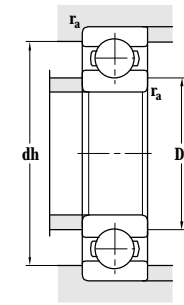
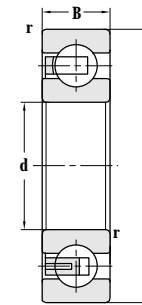
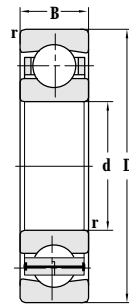
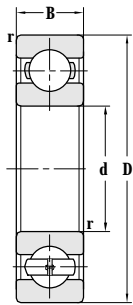

Principal dimensions				Basic load ratings		Limit speed ratings	
d	D	B	r _{min}	C _r	C _{or}	Grease	Oil
mm				kN		r/min	
360	440	38	2.1	173	242	1100	1400
	480	56	3	282	425	1100	1400
	480	56	3	282	425	1100	1400
	480	56	3	282	425	1100	1400
	480	56	3	282	425	1100	1400
	509.5	70	3	335	510	1000	1300
	530	82	5	355	620	1000	1300
	540	82	5	443	705	1000	1300
	540	57	4	345	545	1000	1200
	540	82	5	443	705	1000	1300
540	82	5	443	705	1000	1300	
380	480	46	2.1	232	375	1000	1300
	480	46	2.1	232	375	1000	1300
	520	44	3	241	365	1000	1300
	520	44	3	241	365	1000	1300
	520	65	4	335	550	1000	1300
	520	65	4	335	550	1000	1300
	560	57	4	368	615	940	1100
	560	82	5	443	720	950	1200
	560	82	5	443	720	950	1200
	560	82	5	443	720	950	1200
	560	82	5	443	720	950	1200
	560	82	5	443	720	950	1200
	560	82	5	443	720	950	1200
400	500	31	2	159	277	1000	1200
	500	46	2.1	242	397	1000	1200
	500	46	2.1	242	397	1000	1200
	540	44	3	258	435	980	1250
	540	65	4	350	580	950	1200
	540	65	4	350	580	950	1200
	600	90	5	500	830	900	1100
	600	90	5	500	830	900	1100
	600	90	5	500	830	900	1100
	720	130	6	630	1080	750	900

Designations	Abutment and fillet dimensions			Weight
	D _{smin}	dh _{max}	r _{amax}	
	mm			kg
61872	351	429	2	12.2
61972	373	467	2.5	30.9
FL-61972MA	373	467	2.5	28.9
61972/P64	373	467	2.5	30.9
61972F3	373	467	2.5	30.2
62972X3	374	495.5	2.5	48.0
6072X1/C9	382	508	4	59.8
6072F3	380	520	4	64.7
16072	376	524	3	48.4
6072F1	380	520	4	64.7
6072M	380	520	4	65.7
61876F1	391	469	2	19.0
61876F3	391	469	2	19.0
60976	396	504	3	29.2
60976/YA8	396	504	3	29.7
61976/W281	396	504	3	39.8
61976	396	504	3	39.8
16076	394	545	3	50.0
6076F3	398	542	4	65.6
6076N1	398	542	4	69.3
6076N1F3	398	542	4	65.6
6076	398	542	4	69.3
6076M	398	542	4	66.4
60880	410	490	2	15.0
61880	413	488	2	21.0
61880MA	413	488	2	20.2
60980	411	525	2.5	27.5
61980	416	524	3	43.6
61980F3	416	524	3	39.4
6080F1	420	580	4	86.5
6080F3	420	580	4	86.5
6080M	420	580	4	87.9
61280X2MA/YA3	477.45	642.55	2	250

Deep Groove Ball Bearing

d 420~500 mm

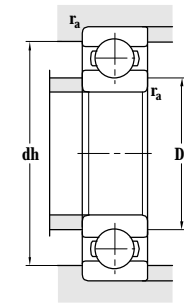
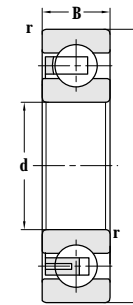
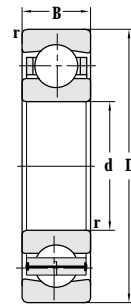
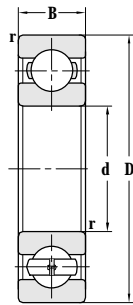

Principal dimensions				Basic load ratings		Limit speed ratings	
d	D	B	r _{min}	C _r	C _{or}	Grease	Oil
mm				kN		r/min	
420	520	46	2.1	245	420	980	1250
	520	46	2.1	245	420	980	1250
	560	65	4	320	520	900	1100
	560	65	4	320	520	900	1100
	560	65	4	320	520	900	1100
	560	65	4	320	520	900	1100
	620	90	5	490	860	900	1110
	620	90	5	490	860	900	1110
440	540	31	2	155	285	870	1000
	540	46	2.1	245	445	870	1000
	600	50	4	305	550	870	1000
	600	74	4	390	650	900	1100
	600	74	4	380	650	900	1100
	650	94	6	525	880	850	1000
460	580	56	3	303	435	900	1100
	580	56	3	265	435	900	1100
	620	72	4	410	710	870	1100
	620	72	4	410	710	870	1100
	620	74	4	405	680	850	1000
	620	72	4	410	710	850	1000
	680	100	6	560	1020	800	950
	680	100	6	560	1020	800	950
480	600	56	3	315	610	870	1100
	650	78	5	417	743	800	950
	700	100	6	605	1115	740	900
500	620	37	2.1	220	445	800	950
	620	56	3	325	607	800	950
	660	75	5	395	716	750	900
	660	75	5	395	716	750	900
	670	78	5	450	860	760	900
	670	78	5	450	845	760	900
	720	100	6	575	1020	750	900

Designations	Abutment and fillet dimensions			Weight
	D _{smin}	dh _{max}	r _{amax}	
	mm			kg
61884	431	508	2	22.2
FL-61884MA	431	508	2	23.0
61984F3/C9	436	544	3	41.9
61984F3	436	544	3	41.9
61984MA	436	544	3	46.2
FL-61984MA/C3	436	544	3	46.2
6084	438	602	4	90.5
6084M	438	602	4	92.0
60888	450	531	2	16.5
61888	453	528	2	22.3
60988	456	585	3	46.1
61988F3	456	584	3	60.5
61988	455	585	3	61.6
6088	466	624	5	108
61892	473	567	2.5	34.3
61892MA	473	567	2.5	34.7
61992	475	604	3	63.0
FL-61992X2MA	475	604	3	62.8
61992F3	476	604	3	63.0
61992X2MA	476	604	3	62.8
6092F1	483	657	5	121
6092F3	483	657	5	121
61896	492	587	2.5	36.0
61996F3	498	632	4	74.1
6096	504	676	5	133
608/500	510	609	2	20
618/500M	513	607	2.5	37.3
619/500X3F1	520	650	4	68.8
619/500X3F3	520	650	4	68.8
619/500	519	651	4	79
619/500F3	519	651	4	79.7
60/500	526	694	5	135

Deep Groove Ball Bearing

d 500~600 mm

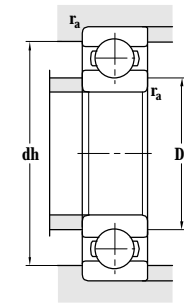
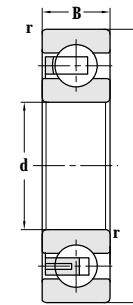
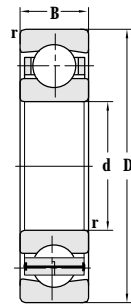
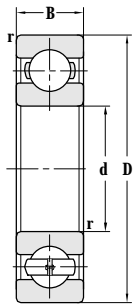

Principal dimensions				Basic load ratings		Limit speed ratings		
d	D	B	r _{min}	C _r	C _{or}	Grease	Oil	
mm				kN		r/min		
500	720	100	6	580	1100	750	900	
	720	100	6	580	1100	750	900	
530	650	56	3	325	640	750	900	
	650	56	3	325	640	750	900	
	650	56	3	325	640	750	900	
	710	57	4	410	810	700	850	
	710	82	5	470	885	700	850	
	710	82	5	470	885	700	850	
	758	100	6	580	1130	680	830	
	760	100	6	580	1130	680	830	
	780	112	6	635	1260	670	810	
	780	112	6	680	1300	670	800	
	780	112	6	680	1300	670	800	
	560	680	37	2.1	220	460	710	860
680		56	3	331	667	700	850	
680		56	3	331	667	700	850	
680		56	3	331	667	700	850	
680		56	3	331	667	700	850	
750		85	5	475	925	670	800	
750		85	5	475	925	670	800	
820		115	6	670	1370	630	750	
820		115	6	630	1500	630	750	
820		115	6	670	1370	630	750	
570		799	115	6	641	1280	480	600
600		700	100	3	345	710	670	800
	730	42	3	260	550	670	800	
	730	42	3	261	485	670	800	
	730	60	3	350	735	670	800	
	730	60	3	350	735	670	800	
	869	110	6	680	1450	650	750	
	870	118	6	680	1450	600	700	
	870	118	6	692	1450	600	700	

Designations	Abutment and fillet dimensions			Weight
	D _{smin}	dh _{max}	ra _{max}	
	mm			kg
60/500N1MAS	523	697	5	136
60/500-BG	523	697	5	135
618/530F1	543	637	2.5	41.1
618/530MA	543	637	2.5	42.1
618/530F3	543	637	2.5	41.1
609/530	545	696	3	60.0
619/530F1	548	692	4	91.6
619/530F3	548	692	4	91.6
60/530X3	543	745	5	149
60/530X3-1	556	754	5	153
60/530	552	757	5	188
60/530N1MA	556	754	5	185
60/530N1MA/YAB	553	757	5	185
608/560	572	670	2	30.0
618/560F1	573	667	2.5	42.1
618/560F3	573	667	2.5	42.1
618/560MA	573	667	2.5	42.7
618/560/P5	573	667	2.5	42.8
619/560F1	578	732	4	110
619/560F3	578	732	4	110
60/560F3	586	794	5	205
60/560N1MAS/C9	586	794	5	208
60/560F1	586	794	5	205
66/570X1M	598	770	5	181
D66/600	610	690	2.5	60.6
608/600	614	718	2.5	41.0
608/600MA	614	718	2.5	41.0
618/600	613	717	2.5	52.7
618/600/W33X	613	717	2.5	52.2
60/600X3/C3H	623	846	5	219
60/600	623	847	5	233
60/600/HC	623	847	5	233

Deep Groove Ball Bearing

d 600~750 mm

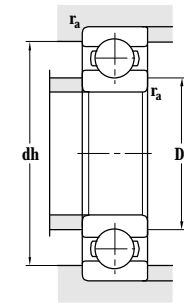
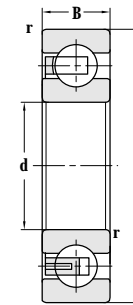
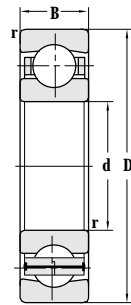
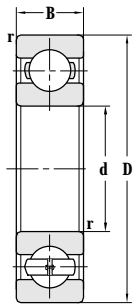

Principal dimensions				Basic load ratings		Limit speed ratings	
d	D	B	r _{min}	C _r	C _{or}	Grease	Oil
mm				kN		r/min	
600	870	118	6	725	1510	600	700
600.3	819	90	5	560	1130	650	750
630	780	48	3	365	710	640	760
	780	69	4	424	926	630	750
	780	69	4	424	926	630	750
	780	69	4	420	760	630	750
	850	71	5	475	1050	600	710
	850	100	6	610	1330	600	710
	920	128	7.5	800	1750	550	660
650	920	118	6	750	1600	550	660
670	820	69	4	424	960	560	670
	820	69	4	424	960	560	670
	820	69	4	424	960	560	670
	920	118	6	750	1600	530	630
	820	69	4	424	960	560	670
	820	69	4	424	960	560	670
	900	73	5	540	1210	580	700
	900	103	6	670	1450	530	630
	980	136	7.5	885	1900	500	600
	980	136	7.5	885	1900	500	600
	980	136	7.5	885	1900	500	600
710	870	74	4	456	1056	530	630
	870	74	4	456	1056	530	630
	870	74	4	456	1056	530	630
	950	78	5	545	1280	500	610
	950	106	6	645	1510	500	610
	1030	140	7.5	935	2180	490	560
750	920	78	5	515	1225	480	610
	1000	112	6	745	1790	490	570
	1090	150	7.5	975	2370	450	530

Designations	Abutment and fillet dimensions			Weight
	D _{smin}	dh _{max}	r _{amax}	
	mm			kg
60/600/HCE-1	623	847	5	236
66/600.3/HCYA13	623	796	5	147
608/630	643	767	2.5	41.0
618/630	645	765	3	76.5
618/630MA	645	765	3	77.8
618/630L/P5	645	765	3	65.7
609/630	649	832	4	112
619/630	654	829	5	163
60/630	657	891	6	280
66/650N1	678	891	5	254
618/670	685	805	3	82.2
618/670F1	685	805	3	80.8
618/670F3	685	805	3	80.8
66/650N1	673	897	5	254
618/670Q1	685	805	3	82.8
618/670/C4	685	805	3	82.2
609/670	689	882	4	143
619/670MA	693	877	5	194
60/670F3	698	952	6	361
60/670N1	698	952	6	366
60/670N1/YB2	698	952	6	366
618/710F3	725	855	3	96.1
618/710	725	855	3	98.1
618/710MA	725	855	3	98.8
609/710	729	932	4	148
619/710	732	928	5	218
60/710	738	1002	6	375
618/750	766	901	4	114
619/750	774	977	5	260
60/750	778	1061	6	490

Deep Groove Ball Bearing

d 800~1000 mm

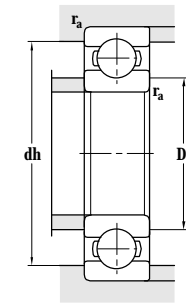
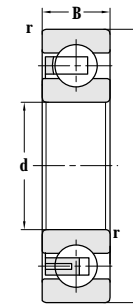
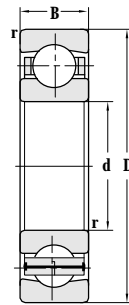
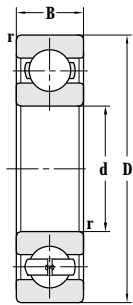

Principal dimensions				Basic load ratings		Limit speed ratings		
d	D	B	r _{min}	C _r	C _{or}	Grease	Oil	
mm				kN		r/min		
800	980	57	4	390	990	430	510	
	980	82	5	545	1340	430	510	
	980	82	5	545	1360	430	510	
	980	82	5	545	1360	430	510	
	1060	115	6	815	2100	430	500	
	1060	115	6	800	1960	430	500	
	1150	115	7.5	950	2080	500	550	
	1150	155	7.5	985	2530	400	480	
	1150	115	7.5	845	2080	500	550	
	850	1030	57	4	385	1000	450	500
1030		82	5	555	1300	450	530	
1030		82	5	545	1400	430	500	
1030		82	5	545	1400	430	500	
1030		82	5	555	1300	430	500	
1030		82	5	555	1300	450	530	
1120		118	6	815	2150	400	480	
1220		165	7.5	1090	2980	370	430	
900		1090	85	5	600	1540	380	450
		1180	122	6	830	2270	360	440
	1280	170	7.5	1080	3120	330	410	
950	1150	90	5	660	1620	360	430	
	1150	90	5	660	1620	360	430	
	1150	90	5	660	1620	360	430	
	1200	90	5	660	1620	360	430	
	1250	132	7.5	985	2850	330	410	
	1250	132	7.5	930	2430	340	400	
	1360	180	7.5	1145	3315	310	380	
960	1160	90	5	630	1550	360	430	
1000	1220	71	5	540	1550	350	400	
	1220	100	6	680	1720	340	400	
	1220	100	6	635	1720	340	400	

Designations	Abutment and fillet dimensions			Weight
	D _{smin}	dh _{max}	r _{amax}	
	mm			kg
608/800	815	966	3	100
618/800	820	960	4	132
618/800MA	820	960	4	133
618/800MA/P5	820	960	4	133
619/800	823	1037	5	280
619/800F3	823	1037	5	289
160/800X2F1	820	1130	6	427
60/800	828	1120	6	540
160/800X2F3	820	1130	6	427
608/850	865	1015	3	75
618/850	870	1010	4	151
618/850MA	868	1012	4	141
618/850MA/C9	868	1012	4	141
618/850F1	868	1012	4	147
618/850F3	870	1010	4	144
619/850	873	1098	5	315
60/850	879	1190	6	640
618/900F3	918	1072	4	155
619/900	923	1156	5	355
60/900	928	1252	6	725
618/950F1/C9	968	1132	4	188
618/950F3/C9	968	1132	4	188
618/950F1/C9	968	1132	4	188
618/950X1F3	968	1182	4	252
619/950	979	1222	6	395
619/950/C9	978	1222	6	460
60/950	979	1330	6	850
66/960MA	978	1142	4	199
608/1000	1018	1201	4	175
618/1000F3	1023	1197	5	230
618/1000F1	1026	1194	5	230

Deep Groove Ball Bearing

d 1000~1500 mm

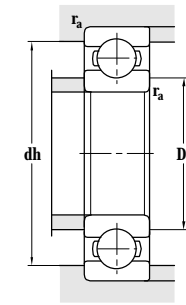
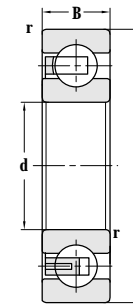
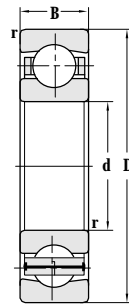
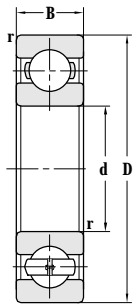

Principal dimensions				Basic load ratings		Limit speed ratings	
d	D	B	r _{min}	C _r	C _{or}	Grease	Oil
mm				kN		r/min	
1000	1220	100	6	680	1720	340	400
	1320	103	6	800	2340	330	380
	1320	140	7.5	950	2530	330	380
	1420	185	7.5	1320	3900	280	340
1060	1280	100	6	710	2140	310	350
	1400	150	7.5	985	3030	290	330
	1500	195	9.5	1310	3750	260	320
	1500	195	9.5	1310	3750	260	320
1120	1360	106	6	725	2180	290	350
	1360	106	6	910	2500	290	350
	1460	150	7.5	1010	3070	270	330
	1580	200	9.5	1430	4480	250	300
1180	1420	106	6	920	2580	320	360
	1420	106	6	920	2580	320	360
	1420	106	6	920	2580	320	360
	1540	160	7.5	1115	3630	210	270
1240	1480	112	6	930	2660	300	340
	1750	218	9.5	1590	5000	200	250
1250	1500	112	6	830	2740	210	270
	1750	218	9.5	1590	5000	200	250
	1560	150	6	939	2750	220	280
	1720	150	6	956	2830	200	260
1280	1600	150	6	956	2830	200	260
	1600	122	6	955	2830	200	260
	1720	128	7.5	1180	4060	190	230
	1720	175	7.5	1140	3500	360	450
1320	1720	128	7.5	1180	4060	190	230
	1720	175	7.5	1140	3500	360	450
1400	1700	132	7.5	1070	3980	190	230
	1820	185	9.5	1550	5520	180	230
1500	1820	140	7.5	1190	4310	170	210

Designations	Abutment and fillet dimensions			Weight
	D _{smin}	dh _{max}	r _{amax}	
	mm			kg
618/1000MA	1023	1197	5	234
609/1000	1023	1297	5	405
619/1000	1028	1292	6	548
60/1000	1028	1392	6	925
618/1060	1084	1259	5	265
619/1060	1089	1371	6	615
60/1060	1094	1466	8	1090
60/1060/HBYB2	1094	1466	8	1141
618/1120	1143	1336	5	310
618/1120M	1143	1336	5	313
619/1120	1148	1432	6	640
60/1120	1155	1546	8	1245
618/1180M	1203	1397	5	317
618/1180F1	1206	1394	5	310
618/1180F3	1203	1397	5	310
619/1180	1209	1513	6	765
618/1240X1	1266	1454	5	356
618/1250	1274	1479	5	390
60/1250M/P5	1290	1710	8	1708
66/1280F1/C9	1306	1534	5	606
618/1320X2F1/C9	1343	1577	5	520
618/1320F3	1343	1377	5	512
609/1320	1348	1691	6	835
619/1320F3/YB2	1348	1692	6	1112
618/1400	1427	1672	6	620
619/1400	1434	1777	8	1260
618/1500	1528	1791	6	695

Deep Groove Ball Bearing

d 1500~1700 mm

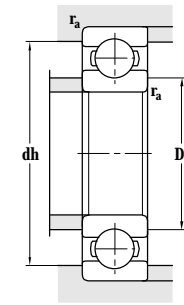
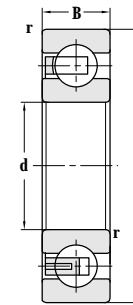
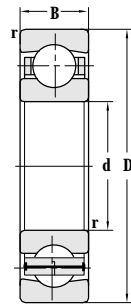
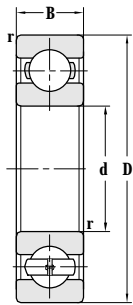

Principal dimensions				Basic load ratings		Limit speed ratings	
d	D	B	r _{min}	C _r	C _{or}	Grease	Oil
mm				kN		r/min	
1500	1950	195	9.5	1680	6220	160	190
	2060	200	9.5	1820	6300	260	300
1600	1950	155	7.5	1240	4750	150	180
	2060	200	9.5	1820	6300	260	300
1700	2060	160	7.5	1240	4950	130	160
	2180	212	9.5	1950	7680	120	150

Designations	Abutment and fillet dimensions			Weight
	D _{smin}	dh _{max}	r _{amax}	
	mm			kg
619/1500	1535	1915	8	1515
618/1600	1627	1923	6	975
619/1600	1634	2026	8	1711
619/1600F3	1634	2026	8	1681
618/1700	1729	2032	6	1110
619/1700	1735	2145	8	1930

Deep Groove Ball Bearing(With Shields)



d 10-30 mm

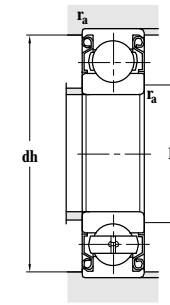
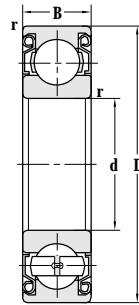
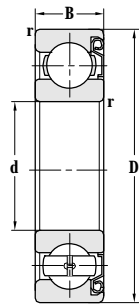

Principal dimensions				Basic load ratings		Limit speed ratings	
d	D	B	r _{min}	C _r	C _{or}	Grease	Oil
mm				kN		r/min	
10	30	9	0.6	6.50	3.00	24000	30000
12	32	10	0.6	6.50	3.00	22000	28000
	32	10	0.6	6.50	3.00	22000	28000
15	35	11	0.6	8.00	4.00	19000	24000
	35	11	0.6	8.00	4.00	19000	24000
17	40	12	0.6	9.75	4.8	17000	20000
	40	12	0.6	9.75	4.8	17000	20000
20	42	12	0.6	9.55	5.00	17000	19000
	42	12	0.6	9.40	5.00	17000	19000
	47	14	1	13.0	6.70	15000	18000
	47	14	1	13.0	6.70	15000	18000
	52	15	1	13.8	6.90	13000	16000
	62	16	1	18.2	10.0	10000	13000
25	47	12	0.6	11.4	6.28	15000	18000
	47	12	0.6	10.1	5.85	15000	15000
	52	15	1	14.3	8.00	12000	18000
	52	15	1	14.3	8.00	12000	15000
	62	17	1.1	22.4	11.5	11000	14000
28	58	16	1.1	12.0	9.00	11000	13800
	68	18	1.1	19.0	13.0	9500	12000
30	55	13	1	13.2	7.96	12000	15000
	55	13	1	13.2	7.96	12000	15000
	62	16	1	19.5	11.3	10000	13000
	62	16	1	19.5	11.3	10000	13000
	62	16	1	19.5	11.3	10000	13000
	62	16	1	19.5	11.3	10000	13000
	72	19	1.1	28.4	15.4	9000	11000
	72	19	1.1	28.4	15.4	9000	11000

Designations	Abutment and fillet dimensions				Weight
	D _{smin}	D _{smax}	dh _{max}	r _{amax}	
	mm				kg
6200-2Z	13.5	14.5	26	0.6	0.0270
6201-Z	16	16.5	28	0.6	0.0369
6201-2Z	16	16.5	28	0.6	0.0373
6202-Z	19		31	0.6	0.0432
6202-2Z	19		31	0.6	0.0450
6203-2Z	21		36	0.6	0.0665
6203-Z	21		36	0.6	0.0665
6004-Z-DW	24.5		37.5	0.6	0.071
6004-2Z	23.2		38.8	0.6	0.0704
6204-2Z	25		42	1	0.111
6204-Z	25		42	1	0.109
6304-2Z	27		45	1	0.152
6304X3-2Z	35.6		56.4	1	0.255
6304X3/C3	35.6		56.4	1	0.252
6005-Z	28.2		43.8	0.6	0.0769
6005-2Z	28.2		43.8	0.6	0.0783
6205-2Z	30		47	1	0.135
6205-Z	30		47	1	0.136
6305-2Z	32		55	1	0.218
62/28-ZN	35		51	1	0.179
63/28-ZN	35		61	1	0.292
6006-2Z	35		50	1	0.118
6006-Z	34.6		50.4	1	0.119
6206-2Z	35		57	1	0.207
6206-Z	35		57	1	0.208
6206-ZS	35		57	1	0.205
6306-2Z	36.5		65.5	1	0.357
6306-Z	36.5		65.5	1	0.356

Deep Groove Ball Bearing(With Shields)

d 35-50 mm

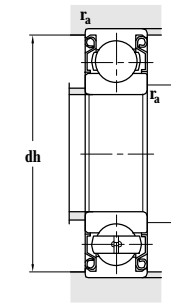
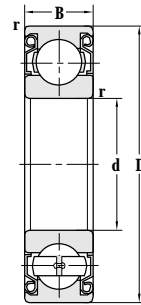
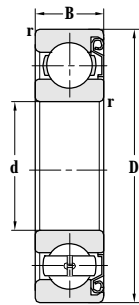

Principal dimensions				Basic load ratings		Limit speed ratings	
d	D	B	r _{min}	C _r	C _{or}	Grease	Oil
mm				kN		r/min	
35	62	14	1	16.0	10.3	10000	13000
	62	14	1	16.0	10.3	10000	13000
	72	17	1.1	26.0	14.7	9000	11000
	72	17	1.1	26.0	14.7	9000	11000
	80	21	1.5	33.4	19.2	8500	10000
	80	21	1.5	33.4	19.2	8500	10000
	100	25	1.5	51.5	29.0	7100	8500
	100	25	1.5	51.5	29.0	7100	8500
40	68	15	1	16.8	11.6	9500	12000
	68	15	1	16.8	11.6	9500	12000
	80	18	1.1	31.2	18.2	8500	10000
	80	18	1.1	31.2	18.2	8500	10000
	80	18	1.1	31.2	18.2	5600	10000
	90	23	1.5	41.0	24.0	7500	9000
	90	23	1.5	41.0	24.0	7500	9000
	90	23	1.5	41.0	24.0	7500	9000
45	75	16	1	21.2	14.0	9000	11000
	75	16	1	21.2	14.0	9000	11000
	85	19	1.1	33.7	20.7	7500	9000
	85	19	1.1	33.7	20.7	7500	9000
	85	19	1.1	33.7	20.7	7500	9000
	100	25	1.5	48.5	29.5	6700	8000
	100	25	1.5	52.5	30.0	6700	8000
	100	25	1.5	52.5	30.0	6700	8000
	100	25	1.5	52.5	30.0	6700	8000
	120	29	2	73.0	43.0	6000	7000
	50	80	16	1	22.0	16.3	8500
80		16	1	22.0	16.3	8500	10000
90		20	1.1	35.6	22.3	7000	8500
90		20	1.1	35.6	22.3	7000	8500
90		20	1.1	35.6	22.3	7000	8500
110		27	2	62.0	38.0	6300	7500
110		27	2	62.0	38.0	6300	7500
110		27	2	62.0	38.0	6300	7500
110		27	2	62.0	38.0	6300	7500

Designations	Abutment and fillet dimensions				Weight
	D _{smin}	D _{smax}	dh _{max}	r _{amax}	
	mm				kg
6007-2Z	39.6		57.4	1	0.154
6007-2/C3	40		57	1	0.154
6207-2Z	41.5		65.5	1	0.397
6207-Z	41.5		65.5	1	0.390
6307-2Z	43		72	1.5	0.476
6307-Z	43		72	1.5	0.466
6407-Z	46		89	1.5	0.972
6407-2Z	46		89	1.5	0.976
6008-2Z	45		63	1	0.191
6008-RZ	45		63	1	0.196
6208-2Z	46.5	50.5	73.5	1	0.374
6208-Z	46.5		73.5	1	0.367
6208-2RZ	46.5	50.5	73.5	1	0.408
6308-2Z	48	50.5	82	1.5	0.651
6308-2Z/YA7	48	52	82	1.5	0.641
6308-Z	48		82	1.5	0.644
6009-2Z	50.8		69.2	1	0.245
6009-2Z/C3	50.8		69.2	1	0.245
6209-2Z	51.5		78.5	1	0.439
6209-Z	51.5	54	78.5	1	0.434
6209-2Z/YA7	51.5		78.5	1	0.433
6309-2Z-NY	54		91	1.5	0.851
6309-2Z	53		92	1.5	0.850
6309-Z	53	56.5	92	1.5	0.847
6309-2Z/YA7	53		92	1.5	0.831
6409-Z	58		107	2	1.57
6010-2Z	54.6		75.4	1	0.257
6010-Z	54.6		75.4	1	0.257
6210-2Z	56.5		83.5	1	0.484
6210-Z	56.5	58	83.5	1	0.479
6210-2Z/YA7	56.5		83.5	1	0.483
6310-2Z	59		101	2	1.134
6310-Z	59	63	101	2	1.12

Deep Groove Ball Bearing(With Shields)

d 50-65 mm

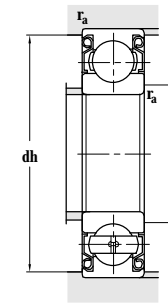
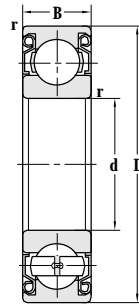
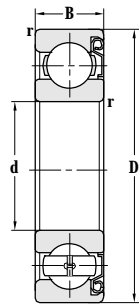

Principal dimensions				Basic load ratings		Limit speed ratings		
d	D	B	r _{min}	C _r	C _{or}	Grease	Oil	
mm				kN		r/min		
50	110	27	2	62.0	38.0	6300	7500	
	130	31	2.1	88.0	52.0	5300	6300	
55	90	18	1.1	29.0	20.7	7500	9000	
	90	18	1.1	29.0	20.7	7500	9000	
	100	21	1.5	44.3	27.8	7500	9000	
	100	21	1.5	44.3	27.8	7500	9000	
	100	21	1.5	44.3	27.8	7500	9000	
	100	21	1.5	44.3	27.8	7500	9000	
	120	29	2	71.5	45.0	5600	6700	
	120	29	2	71.5	45.0	5600	6700	
	120	29	2	71.5	45.0	5600	6700	
	120	29	2	71.5	45.0	5600	6700	
	140	33	2.1	95.0	60.0	5000	6000	
	140	33	2.1	95.0	60.0	5000	6000	
	60	85	13	1	17.0	15.1	7500	9000
		95	18	1.1	30.0	23.0	6700	8000
110		22	1.5	53.0	36.0	6000	7000	
110		22	1.5	53.0	36.0	6000	7000	
110		22	1.5	53.0	36.0	6000	7000	
130		31	2.1	82.0	50.0	5000	6000	
130		31	2.1	82.0	50.0	5000	6000	
130		31	2.1	82.0	50.0	5000	6000	
150		35	2.1	107	68.5	4800	5600	
150		35	2.1	107	68.5	4800	5600	
65		100	18	1.1	32.0	25.0	6300	7500
	120	23	1.5	57.0	40.0	5300	6300	
	120	23	1.5	57.0	40.0	5300	6300	
	120	23	1.5	57.0	40.0	5300	6300	
	120	23	1.5	57.0	40.0	5300	6300	
	120	23	1.5	57.0	40.0	5300	6300	
	120	23	1.5	57.0	40.0	5300	6300	
	120	23	1.5	57.0	40.5	5300	6300	
	140	33	2.1	92.5	59.5	5000	6000	
	140	33	2.1	92.5	59.5	5000	6000	

Designations	Abutment and fillet dimensions				Weight
	D _{smin}	D _{smax}	dh _{max}	r _{amax}	
	mm				kg
6310-2Z/YA7	59		101	2	1.11
6410-2Z	64		116	2	1.92
6011-Z	61		84	1	0.388
6011-2Z	61		84	1	0.386
6211-Z	63	65	92	1.5	0.621
6211-2Z	63		92	1.5	0.639
6211-2Z/YA7	63		92	1.5	0.631
6211F2-2Z/C9S2	63		92	1.5	0.631
6311-2Z	64		111	2	1.38
6311-Z	64	69	111	2	1.38
6311-2Z/YA7	64		111	2	1.36
6311-2RZ	64		111	2	1.37
6411-Z	69		126	2	2.32
6411-2Z	69		126	2	2.28
61912-2Z	64.6		80.4	1	0.198
6012-2Z	66		89	1	0.417
6212-Z	68	71	102	1.5	0.794
6212-2Z	68		102	1.5	0.800
6212-2Z/YA7	68		102	1.5	0.792
6312-2Z	71	76	119	2	1.71
6312-2Z/YA7	71		119	2	1.67
6312-Z	71		119	2	1.75
6412-Z	74		136	2	2.77
6412-2Z	74		136	2	2.75
6013-2Z	71.5		93.5	1	0.459
6213-2Z	73		112	1.5	1.06
FL-6213-2Z	73		112	1.5	1.06
6213-Z	73		112	1.5	0.690
6213-Z/HQ1	73		112	1.5	1.05
6213-2Z/YA7	73	79	112	1.5	0.679
6213F2-2Z/C9S2	73		112	1.5	1.06
6313-2Z/YA7	76	81	129	2	2.19
6313-2Z	76		129	2	2.12

Deep Groove Ball Bearing (With Shields)

d 65-85 mm

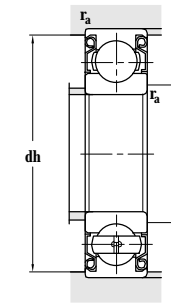
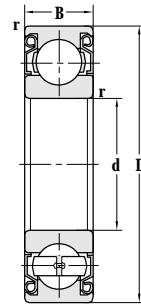
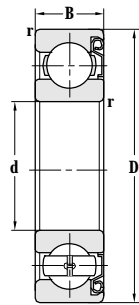

Principal dimensions				Basic load ratings		Limit speed ratings		
d	D	B	r _{min}	C _r	C _{or}	Grease	Oil	
mm				kN		r/min		
65	140	33	2.1	92.5	59.5	5000	6000	
70	110	20	1.1	38.0	30.0	6000	7000	
	125	24	1.5	61.2	43.2	5000	6000	
	125	24	1.5	61.2	43.2	5000	6000	
	125	24	1.5	61.2	43.2	5000	6000	
	127	28.4	1.5	56.0	46.5	5000	6000	
	150	35	2.1	107	68.0	4500	5300	
	150	35	2.1	107	68.0	4500	5300	
	150	35	2.1	107	68.0	4500	5300	
	150	35	2.1	107	68.0	4500	5300	
75	105	16	1	26.5	23.5	6000	7000	
	115	20	1.1	38.0	31.0	5600	6700	
	115	20	1.1	38.0	31.0	5600	6700	
	130	25	1.5	66.0	50.0	4800	5600	
	130	25	1.5	66.0	50.0	4800	5600	
	130	25	1.5	66.0	50.0	4800	5600	
	130	25	1.5	66.0	50.0	4800	5600	
	130	25	1.5	66.0	50.0	4800	5600	
	160	37	2.1	113	77	4300	5000	
	160	37	2.1	113	77	4300	5000	
	160	37	2.1	113	77	4300	5000	
	80	110	16	1	27.6	25.3	5600	6700
		125	22	1.1	47.5	40.0	5300	6300
125		22	1.1	47.5	40.0	5300	6300	
140		26	2	71.5	54.5	4500	5300	
140		26	2	71.5	54.5	4500	5300	
140		26	2	71.5	54.5	4500	5300	
140		26	2	71.5	54.5	4500	5300	
170		39	2.1	125	86.5	3800	4500	
170		39	2.1	125	86.5	3800	4500	
170		39	2.1	125	86.5	3800	4500	
85		120	18	1.1	31.0	29.0	5000	6000

Designations	Abutment and fillet dimensions				Weight
	D _{smin}	D _{smax}	dh _{max}	r _{amax}	
	mm				kg
6313-Z	76		129	2	2.12
6014-2Z	76		104	1	0.625
6214-2Z/YA7	78	83	117	1.5	1.11
6214-Z	78		117	1.5	1.13
6214-Z	78		117	1.5	1.13
6214-ZSC	78		117	1.5	1.29
6314-2Z	81		139	2	2.62
6314-2Z/P6CMV2	81		139	2	2.51
6314-2Z/YA7	81	87	139	2	2.59
6314-Z	81		139	2	2.59
61915-2Z	79.6		100	1	0.357
6015-2Z	81.5		108.5	1	0.624
6015-Z	81.5		108.5	1	0.658
6215-2Z	83		122	1.5	1.21
6215-Z	83		122	1.5	1.21
6215-Z/HQ1	83		122	1.5	1.22
6215-2Z/YA7	83	87	122	1.5	1.19
6215F2-2Z/C9S2	83		122	1.5	1.16
6315-2Z	86		149	2	3.11
6315-Z	86		149	2	3.03
6315-2Z/YA7	86	94	149	2	3.12
61916-2Z	84.6		105	1	0.357
6016-Z	86.5		118.5	1	0.860
6016-2Z	86.5		118.5	1	0.875
6216-2Z/YA7	89	94	131	2	1.45
6216-2Z	89		131	2	1.50
FL-6216-2Z	89		131	2	1.50
6216-Z	89		131	2	1.47
6316-Z	91		159	2	3.36
6316-2Z	91		159	2	3.72
6316-2Z/YA7	91	100	159	2	3.69
61917	92		113	1	0.557

Deep Groove Ball Bearing (With Shields)

d 85-100 mm

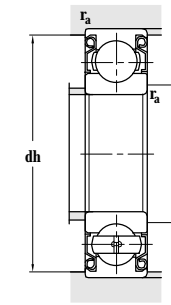
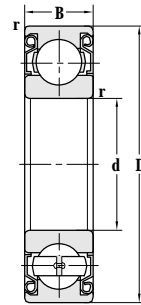
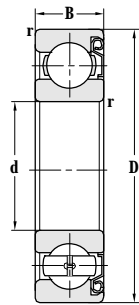

Principal dimensions				Basic load ratings		Limit speed ratings	
d	D	B	r _{min}	C _r	C _{or}	Grease	Oil
mm				kN		r/min	
85	130	22	1.1	47.5	40.0	5000	6000
	150	28	2	84.0	62.0	4300	5000
	150	28	2	84.0	62.0	4300	5000
	150	28	2	84.0	62.0	4300	5000
	180	41	3	102	96.5	4300	5000
	180	41	3	102	96.5	4300	5000
	180	41	3	102	96.5	4300	5000
	180	41	3	102	96.5	4300	5000
	180	41	3	102	96.5	4300	5000
	180	41	3	102	96.5	4300	5000
90	140	24	1.5	58.5	50.1	4800	5600
	140	24	1.5	58.5	50.0	4800	5600
	160	30	2	97.0	72.0	3800	4500
	160	30	2	97.0	72.0	3800	4500
	160	30	2	97.0	72.0	3800	4500
	190	43	3	144	108	3400	4000
	190	43	3	144	108	3400	4000
	190	43	3	144	108	3400	4000
	190	43	3	144	108	3400	4000
	190	43	3	144	108	3400	4000
95	130	18	1.1	33.8	33.0	4600	5400
	145	24	1.5	78.5	54.0	4500	5300
	145	24	1.5	78.5	54.0	4500	5300
	145	24	1.5	78.5	54.0	4500	5300
	170	32	2.1	110	80.0	3600	4300
	170	32	2.1	110	80.0	3600	4300
	170	32	2.1	110	80.0	3600	4300
	200	45	3	152	118	3200	3800
	200	50	3	152	118	3200	3800
	200	45	3	152	118	3200	3800
	200	45	3	152	118	3200	3800
	200	45	3	152	118	3200	3800
	100	150	24	1.5	62.4	52.9	4300
150		24	1.5	62.4	52.9	4300	5000
150		24	1.5	62.4	52.9	4300	5000

Designations	Abutment and fillet dimensions				Weight
	D _{smin}	D _{smax}	dh _{max}	r _{amax}	
	mm				kg
6017-2Z	92		123	1	0.965
6217-Z	94		141	2	1.85
6217-2Z	94	99	141	2	1.85
6217-2Z/YA7	94	99	141	2	1.81
6317-Z	98		167	2.5	4.35
6317-2Z	98		167	2.5	4.35
6317-2Z/YA7	98	107	167	2.5	4.35
IS-6317-2Z/P6CMV2	98		167	2.5	4.30
6317-2Z/P6CMV2	98		167	2.5	4.30
6018-Z	98		132	1.5	1.16
6018-2Z	98		132	1.5	1.17
6218-Z	99		151	2	2.21
6218-2Z	99		151	2	2.21
6218-2Z/YA7	99	105	151	2	2.20
6318-2Z/YA7	103	114	177	2.5	5.04
6318M-Z/YA8P54	103		177	2.5	6.39
6318-2Z	103		177	2.5	5.07
6318-Z	103		177	2.5	5.04
61919-Z	101.5		123.5	1	0.579
6019-Z	103		137	1.5	1.16
6019-Z/HQ1	103		137	1.5	1.31
6019-2Z	103		137	1.5	1.17
6219-Z	106	111	159	2	2.63
6219-2Z	106	111	159	2	2.65
6219-2Z/YA7	106	111	159	2	2.62
6319-2Z	108	113	187	2.5	5.93
6319X2K-2Z	77		187	2.5	6.40
6319-Z	109		186	2.5	5.87
IS-6319	109		186	2.5	5.48
6319-2Z/YA7	108	113	187	2.5	5.89
6020-2Z	108		142	1.5	1.17
6020-2Z/C9	108	110	142	1.5	1.13
6020-Z	108		142	1.5	1.15

Deep Groove Ball Bearing (With Shields)

d 100~130 mm

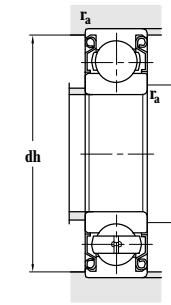
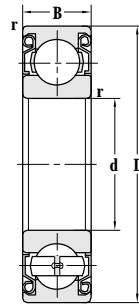
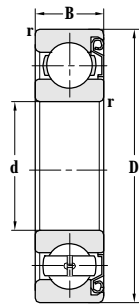

Principal dimensions				Basic load ratings		Limit speed ratings		
d	D	B	r _{min}	C _r	C _{or}	Grease	Oil	
mm				kN		r/min		
100	180	34	2.1	122	93.0	3400	4000	
	180	34	2.1	122	93.0	3400	4000	
	180	34	2.1	122	93.0	3400	4000	
	215	47	3	173	141	2800	3600	
	215	47	3	173	141	2800	3600	
	215	47	3	173	141	2800	3600	
105	160	26	2	73.0	62.8	4000	4800	
	190	36	2.1	135	102	3200	3800	
	225	49	3	240	154	2800	3400	
110	150	20	1.1	40.5	41.5	3900	4600	
	150	20	1.1	40.5	41.5	3900	4600	
	170	28	2	82.0	73.5	3800	4500	
	170	28	2	82.0	70.6	3800	4500	
	170	28	2	82.0	70.6	3800	4500	
	175	31	2.3	158	176	3800	4500	
	175	31	2.3	158	176	3800	4500	
	200	38	2.1	145	114	2800	3400	
	200	38	2.1	145	114	2800	3400	
	240	50	3	195	176	2400	3000	
	240	50	3	195	176	2400	3000	
	120	150	16	1	24.5	28.0	3800	4500
150		16.1	1	24.5	28.0	3800	4500	
165		22	1.1	53.0	54.0	3400	4000	
165		22	1.1	53.0	54.0	3400	4000	
180		28	2	85.5	80.0	3400	4000	
180		28	2	85.5	80.0	3400	4000	
180		28	2	85.5	80.0	3400	4000	
215		40	2.1	154	130	2800	3400	
215		40	2.1	154	130	2800	3400	
260		55	3	217	196	2400	3000	
130		180	24	1.5	65.0	67.0	3400	4000
		180	24	1.5	65.0	67.0	3400	4000

Designations	Abutment and fillet dimensions				Weight
	D _{smin}	D _{smax}	dh _{max}	r _{amax}	
	mm				kg
6220-Z	111		169	2	3.26
6220-2Z	111		169	2	3.26
6220-2Z/YA7	111	118	169	2	3.23
6320-Z	113		202	2.5	7.12
6320-2Z	113	131	202	2.5	7.14
6320-2Z/YA7	113	131	202	2.5	7.13
6021-2Z/C3Z1	116		149	2	1.66
6221-2Z	117		178	2	3.94
6321-2Z	119		211	2.5	8.12
61922	116.5		143.5	1	0.918
61922M	116.5		143.5	1	1.01
6022-Z/HQ1	119		161	2	2.40
6022-Z	119		161	2	1.94
6022-2Z	119		161	2	1.96
6022X3M-Z	122		163	2.3	2.67
60722	122		163	2.3	2.67
6222-Z	121		189	2	4.58
6222-2Z	121		189	2	4.61
6322-2Z	123		227	2.5	9.72
6322-2Z/YA7	123	146	227	2.5	9.69
61824-2Z	125		145	1	0.566
61824-Z	125		145	1	0.565
61924	126.5		158.5	1	1.21
61924M	126.5		158.5	1	1.54
6024-2Z	129	132	171	2	2.15
6024-Z	129	132	171	2	2.09
6024-Z/C9	129	132	171	2	2.09
6224-2Z	131		204	2	5.24
6224-Z	132		203	2	5.25
6324-2Z	134		246	2.5	12.6
61926-2Z	137		173	1.5	1.55
61926-Z	137		173	1.5	1.57

Deep Groove Ball Bearing(With Shields)

d 130~240 mm

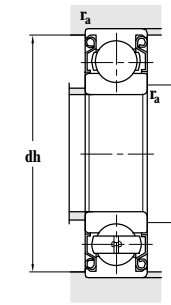
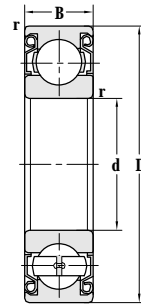
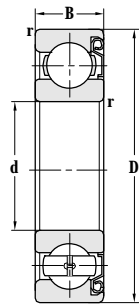

Principal dimensions				Basic load ratings		Limit speed ratings	
d	D	B	r _{min}	C _r	C _{or}	Grease	Oil
mm				kN		r/min	
130	200	33	2	109	98	3200	3800
	200	33	2	109	98	3200	3800
	230	40	3	153	134	2600	3200
	230	40	3	153	134	2600	3200
	280	58	4	240	226	2300	2800
140	175	18	1.1	34.0	40.0	3400	4000
	190	24	1.5	64.0	67.5	2800	3300
	210	33	2	106	102	2700	3200
	250	42	3	166	150	2400	3000
	300	62	4	329	246	2000	2600
150	225	35	2.1	123	117	2600	3200
	270	45	3	189	183	2000	2600
	320	65	4	360	280	1900	2400
160	200	20	1.1	49.5	59	2400	3000
	220	28	2	83.5	90	2300	2900
	220	28	2	83.5	90	2300	2900
170	260	42	2.1	161	166	2200	2800
190	290	46	2.1	191	211	2000	2600
200	310	51	2.1	213	234	1900	2400
	310	34	2	157	179	1900	2400
	360	58	4	288	335	1700	2000
240	300	28	2	103	116	1800	2200

Designations	Abutment and fillet dimensions				Weight
	D _{smin}	D _{smax}	dh _{max}	r _a max	
	mm				kg
6026-Z	139		191	2	3.29
6026-2Z	139		191	2	3.29
6226-Z	144		216	2.5	6.35
6226-2Z	144		216	2.5	6.36
6326-2Z	150		265	3	15.4
61828-2Z	146		169	1	0.845
61928-2Z	147		183	1.5	1.72
6028-Z	149		201	2	3.46
6228-2Z	154		236	2.5	7.50
6328-2Z	157		283	3	18.9
6030-2Z	161		214	2	4.16
6230-2Z	164		256	2.5	10.0
6330-2Z	167		303	3	21.0
61832-2Z	165		215	1	1.25
61932-Z	169		211	2	2.69
61932-2Z	169		211	2	2.72
6034-Z	181		249	2	6.82
6038-2Z	201		279	2	9.11
6040-2Z	211		299	2	11.6
16040M-Z	209		301	2	10.3
6240-Z	216		344	3	22.5
61848M-Z/YA8	249		291	2	4.64

Deep Groove Ball Bearing(With Seals)

d 12-28 mm

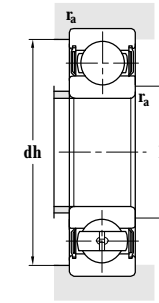
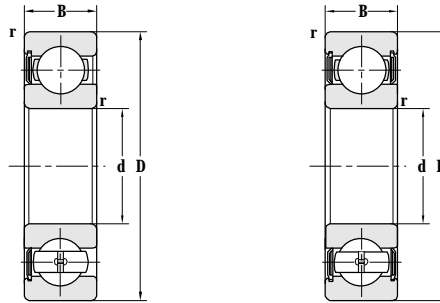

Principal dimensions				Basic load ratings		Limit speed ratings
d	D	B	r _{min}	C _r	C _{or}	Grease
mm				kN		r/min
12	28	8	0.3	5.18	2.26	26000
14	47	14	1	13.6	6.6	11000
17	40	12	0.6	9.55	4.8	12000
	40	14	1	9.6	4.6	12000
18	75	16	1	20	14	5500
20	47	14	1	13.0	6.70	10000
	47	14	1	13.0	6.70	15000
22	56	16	1.1	18.4	9.25	13000
25	37	7	0.3	3.60	2.64	17000
	47	12	0.6	10.6	5.00	9500
	47	12	0.6	11.4	6.28	13000
	52	15	1	14.3	8.00	8500
	52	15	1	14.3	8.00	8500
	52	15	1	14.3	8.00	8500
	52	15	1	14.3	8.00	8500
	52	15	1	14.3	8.00	8500
	62	17	1.1	22.4	11.5	7500
	62	17	1.1	22.4	11.5	7500
	62	17	0.4	22.4	11.5	7500
	62	17	1.1	22.4	11.5	7500
	68	18	1.1	20.2	12.9	7500
25.5	58	16	1	20.5	11.1	11000
	58	16	1	20.5	11.1	11000
28	68	18	1.1	32.5	13.0	6300
	68	18	1.1	25.0	13.9	6300

Designations	Abutment and fillet dimensions				Weight
	D _{smin}	D _{smax}	dh _{max}	r _{amax}	kg
	mm				
6001-2RS	14	14.5	26	0.3	0.023
6303-2RS	19		42	1	0.114
6203-2RS	21	24	36	0.6	0.065
6203X2-FS/YA6	22	21	35	1	0.077
60/18-2RSN/YAD	24.5	51.3	68.5	1	0.365
6204-2RS	25.6		41.4	1	0.121
6204-2RZ	25.6		41.4	1	0.110
63/22-2RS/C3-SAGW	29	30.8	49	1	0.183
61805-2RZ	27		35	0.3	0.022
6005-2RS	29	31	43	0.6	0.079
6005-Z	29		43	0.6	0.077
6205-2RS	30		47	1	0.130
6205-2RZ	30		47	1	0.125
6205-RS2	30		47	1	0.130
6205-RS	30		47	1	0.130
6205-2RS2	30		47	1	0.130
6205-2RS/FR	30		47	1	0.130
6305-2RS	31.5		55.5	1	0.232
6305-RS	31.5		55.5	1	0.223
6305TN1-2RS/YA6	32		55	1	0.211
6305-2RZ	32		55	1	0.222
6305X3/C3YA5	32		61	1	0.296
66/25.5-2RS-BYD	31		52.5	1	0.177
66/25.5-2RS/P53Z2	31		52.5	1	0.186
63/28-RS/HA	34.5		61.5	1	0.305
63/28-2RS1/C3-DZ	34.5	39.5	61.5	1	0.301

Deep Groove Ball Bearing(With Seals)

d 28-35 mm

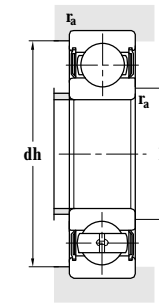
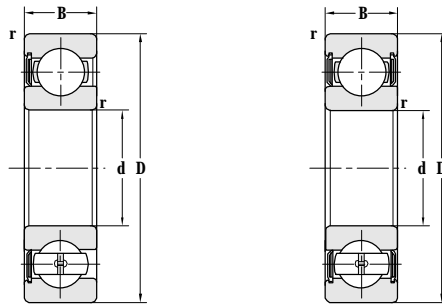

Principal dimensions				Basic load ratings		Limit speed ratings
d	D	B	r _{min}	C _r	C _{or}	Grease
mm				kN		r/min
28	68	18	1.1	23.6	13.1	6300
	68	18	1.1	23.5	13.0	6300
30	55	13	1	13.2	7.96	8000
	55	13	1	13.2	7.96	12000
	62	16	1	19.5	11.3	10000
	62	16	1	19.5	11.3	10000
	62	16	1	19.5	11.3	10000
	62	16	1	19.5	11.3	10000
	62	16	1	19.5	11.3	10000
	62	16	1	19.5	11.3	10000
	62	16	1	19.5	11.3	10000
	62	20	1	19.0	11.0	10000
	72	19	1.1	28.4	15.4	6300
	72	19	1.1	28.4	15.4	6300
	72	19	1.1	28.4	15.4	6300
	72	19	1.7	28.4	15.4	6300
	72	19	1.7	28.4	15.4	6300
	75	20	0.5	25.3	17.5	6300
75	20	0.5	32.5	18.0	9000	
32	80	23	0.5	36.5	20.0	9000
	72	25	1	26.7	15.0	9400
	75	20	1.5	22.0	16.0	8800
	80	23	0.5	27.9	19.6	8400
	80	23	0.3	36.5	19.6	8400
35	62	14	1	16.0	10.3	7000
	62	14	1	16.0	10.3	7000
	64	14	1	16.0	10.3	7000
	72	17	1.1	26.0	14.7	6300
	72	17	1.1	26.0	14.7	6300
	72	17	1.1	26.0	14.7	6300
	72	17	1.1	26.0	14.7	6300
	72	17	1.1	26.0	14.7	6300
	72	17	1.1	26.0	14.7	6300
	72	17	1.1	26.0	14.7	6300
	80	21	1.5	33.4	19.2	6000

Designations	Abutment and fillet dimensions				Weight
	D _{smin}	D _{smax}	dh _{max}	r _{amax}	
	mm				kg
63/28-2RS-DZ	34.5		61.5	1	0.302
63/28-RS	34.5		61.5	1	0.300
6006-2RS	35		50	1	0.118
6006-2RZ	34.6		50.4	1	0.118
6206-RS	35		56	1	0.212
6206-2RS	35		56	1	0.214
6206-2RS-DZ	35		56	1	0.214
6206-RS2	35		56	1	0.212
6206-2RZ	35	38	56	1	0.224
6206-2RS1/C3-DZ	35	38	56	1	0.200
62206-2RS	35	38	56	1	0.255
6306-2RS	36.5	41.5	65.5	1	0.355
6306-RS	36.5	41.5	65.5	1	0.353
6306-2RZ	36.5	41.5	65.5	1	0.355
6306-2RZ/YA6	36.5	41.5	65.5	1	0.355
6306-2RS/YA6	36.5	41.5	65.5	1	0.338
6306X3-2RSN/Y	36.5		68.5	0.5	0.475
450706K	36.5		68.5	0.5	0.474
4507/32KU	37.5		72.5	0.5	0.534
66/32WB1-2RSZ/C9	39		69.5	1	0.408
63/32-2RSN	41.5		65.5	1.5	0.413
63/32X3-2RSN/C9Y	37.5		72.5	0.5	0.534
63/32X3-2RSN/HAY	35		77	0.3	0.534
6007-2RZ	39.6		57.4	1	0.169
6007-2RS	39.6		57.4	1	0.175
6007X1-2RS/C3	39.6		57.4	1	0.196
6207-RS	41.5		65.5	1	0.296
6207-RS2	41.5		65.5	1	0.296
6207-2RS2	41.5		65.5	1	0.299
6207-2RS	41.5		65.5	1	0.299
6207SC-2RS	41.5		65.5	1	0.401
6307-RS	43		72	1.5	0.480

Deep Groove Ball Bearing(With Seals)

d 35-50 mm

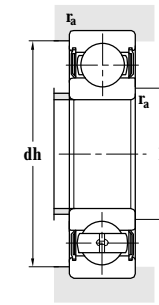
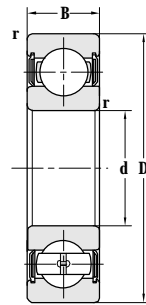
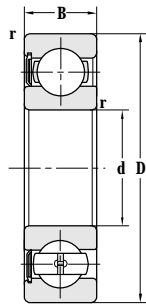

Principal dimensions				Basic load ratings		Limit speed ratings
d	D	B	r _{min}	C _r	C _{or}	Grease
mm				kN		r/min
35	80	21	1.5	33.4	19.2	6000
40	68	15	1	16.8	11.6	6300
	80	18	1.1	31.2	18.2	5600
	80	18	1.1	31.2	18.2	5600
	80	18	1.1	31.2	18.2	5600
	80	21	1.1	31.2	18.2	5600
	85	22	1.5	32.5	20.4	5000
	90	23	1.5	41.0	24.0	5000
	90	23	1.5	41.0	24.0	5000
	90	23	1.5	41.0	24.0	7500
	109.5	31	1.5	41.0	24.0	5000
110	27	2	67.5	36.0	6700	
45	75	16	1	20.0	14.0	5600
	75	16	1	20.0	14.0	5600
	75	16	1	20.0	14.0	5600
	75	16	1	20.0	14.0	5600
	85	19	1.1	33.7	20.7	5300
	85	19	1.1	33.7	20.7	7500
	85	19	1.1	33.7	20.7	5300
	85	19	1.1	33.7	20.7	5300
	85	19	1.1	33.7	20.7	5300
	85	19	1.1	33.7	20.7	5300
	85	21	1.1	33.7	20.7	5300
	100	25	1.5	52.5	30.0	4500
	100	25	1.5	52.5	30.0	4500
	100	25	1.5	48.5	29.5	7000
	100	36	1.5	51.0	31.0	4500
127	31.5	1.5	48.5	29.5	4500	
50	65	7	0.3	5.85	5.69	8100
	72	12	0.6	13.4	11.2	9900
	80	16	1	22.0	16.3	5000
	80	16	1	22.0	16.3	5000
	90	20	1.1	35.6	22.3	4800
	90	33	1.1	35.6	22.3	4800

Designations	Abutment and fillet dimensions				Weight
	D _{smin}	D _{smax}	dh _{max}	r _{amax}	
	mm				kg
6307-2RS	43		72	1.5	0.491
6008-2RS	44.6		63.4	1	0.206
6208-RS	46.5	50.5	73.5	1	0.385
6208-RS2	46.5	50.5	73.5	1	0.385
6208-2RS	46.5	50.5	73.5	1	0.408
62208X2WB-2RS/P53	46.5	50.5	73.5	1	0.525
6308X3-2RS	48		78	1.5	0.704
6308-RS	48		82	1.5	0.643
6308-2RS	48		82	1.5	0.641
6308-2RZ	48		82	1.5	0.643
6308X3-2RS/YA6	48		82	1.5	1.480
6408-2RS/YA5	49		101	2	1.300
6009-RS	50		70	1	0.245
6009-RS2	50		70	1	0.245
6009-2RS	50		70	1	0.250
6009-2RS/FR	50		70	1	0.250
6209-RS	51.5		78.5	1	0.441
6209-2RZ	51.5		78.5	1	0.442
6209-RS2	51.5		78.5	1	0.435
6209-2RS	51.5		78.5	1	0.442
6209-2RSK	51.5		78.5	1	0.433
62209X2WB-2RS/P53	51.5		78.5	1	0.544
6309-2RS	53		92	1.5	0.861
6309-RS	53		92	1.5	0.853
6309-2RZ	53		92	1.5	0.861
62309-2RS	53		92	1.5	1.150
6309X3-2RS/YA6	53		112	1.5	2.040
FL-61810-2RS/P6	53		62	0.3	0.0552
FL-61910-2RS/P5	54		68	0.6	0.135
6010-2RZ	54.6		75.4	1	0.255
6010-2RS	54.6		75.4	1	0.258
6210-2RS	56.5		83.5	1	0.498
62210X2-XRS2	57		83	1	0.727

Deep Groove Ball Bearing(With Seals)

d 50-65 mm

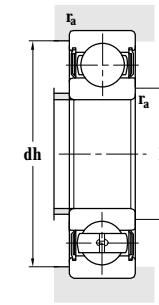
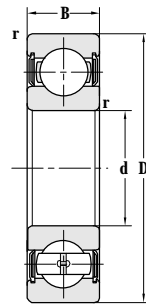
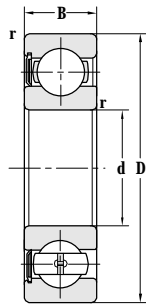

Principal dimensions				Basic load ratings		Limit speed ratings
d	D	B	r _{min}	C _r	C _{or}	Grease
mm				kN		r/min
50	110	27	2	62.0	38.0	4800
	110	27	2	62.0	38.0	4800
	110	27	2	62.0	38.0	4800
	163	46	2	57.5	35.0	4600
55	90	18	1.1	29.0	20.7	4500
	100	21	1.5	44.3	27.8	4300
	120	29	2	71.5	45.0	3800
	120	29	2	71.5	45.0	3800
	120	49.2	2	71.5	45.0	3800
	120	49.2	2	67.0	42.0	3800
	140	33	2.1	89	54	3600
60	95	18	1.1	30.0	23.0	4300
	95	18	1.1	30.0	23.0	4300
	95	18	1.1	30.0	23.0	4300
	95	18	1.1	30.0	23.0	4300
	95	18	1.1	30.0	23.0	4300
	110	22	1.5	53.0	36.0	4000
	110	22	1.5	53.0	36.0	4000
	110	22	1.5	53.0	36.0	4000
	110	22	1.5	53.0	36.0	4000
	110	22	1.5	53.0	36.0	4000
	110	22	1.5	53.0	36.0	4000
	110	22	1.5	53.0	36.0	4000
	110	22	1.5	53.0	36.0	5500
	130	31	2.1	82.0	48.5	3400
	130	31	2.1	82.0	48.5	3400
	130	31	2.1	77.0	49.0	5200
	65	85	10	0.6	11.9	11.5
90		13	1.1	16.0	15.0	7800
100		18	1.1	32.0	25.0	4000
120		23	1.5	57.0	40.0	3500
120		23	1.5	57.0	40.0	3500
140		33	2.1	95.0	59.5	3200
140		33	2.1	95.0	59.5	3200
140		33	2.1	95.0	59.5	3200

Designations	Abutment and fillet dimensions				Weight
	D _{smin}	D _{smax}	dh _{max}	r _{amax}	
	mm				kg
6310-2RS	59	63	101	2	0.926
6310-2RS/HAC3V2YA7	59	63	101	2	1.07
6310TN1-2RZ/C4L	59	63	101	2	1.08
6310X3-2RS	67.5	96	2	4100	5.84
6011-2RS	61		84	1	0.389
6211-2RS	63		92	1.5	0.653
6311-2RS	64		111	2	1.370
6311-RS	64		111	2	1.380
63311TN1-2RZ/C3H	64		111	2	2.190
63311-2RZ/C3L	66		109	2	2.270
6411-2RS/YA5	66		129	2	2.450
6012-2RS	66.5		88.5	1	0.446
6012-RS	66.5		88.5	1	0.430
FL-6012-2RS	66.5		88.5	1	0.446
FL-6012/C3	66.5		88.5	1	0.416
FL-6012/P6	66.5		88.5	1	0.416
6212-2RS	68		102	1.5	0.780
6212-2RS/HAC3V2YA7	68		102	1.5	0.788
6212WB-2RS/P53	68		102	1.5	0.974
6212/HAC3YAB-2RSZ	68		102	1.5	0.928
6212-2RS2/HAYA57	68		102	1.5	0.792
6212-2RS2	69		101	1.5	0.780
FL-6212-2RS/P6	69		101	1.5	0.800
6312-2RS	71		119	2	1.750
6312-RS	71		119	2	1.760
6312-2RZ	71		119	2.1	1.750
FL-61813-2RS/P6	69		81	0.6	0.129
FL-61913-2RS/P5	71.5		83.5	1	0.212
6013-2RS	71		94	1	0.444
6213-2RS	73		112	1.5	1.070
6213-2RSR/C3Z1YA6	73		112	1.5	1.140
6313-2RS	76		129	2	2.360
6313-RS	76		129	2	2.250

Deep Groove Ball Bearing(With Seals)

d 65-95 mm

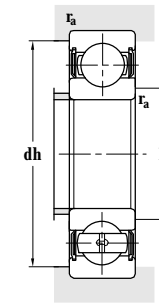
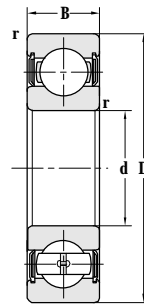
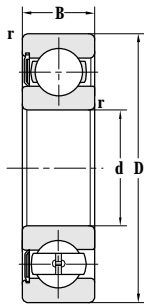

Principal dimensions				Basic load ratings		Limit speed ratings
d	D	B	r _{min}	C _r	C _{or}	Grease
mm				kN		r/min
65	140	33	2.1	95.0	59.5	3200
70	110	20	1.1	38.0	30.0	3600
	125	24	1.5	61.2	43.2	3400
	130	41	1.5	61.0	45.0	3200
	130	41	1.5	61.0	45.0	3200
	150	35	2.1	107	68.0	3000
	150	35	2.1	107	68.0	3000
	150	35	2.1	107	68.0	3000
75	115	20	1.1	40.0	32.2	3400
	115	20	1.1	40.0	32.2	3400
	130	25	1.5	66.0	50.0	3200
	130	25	1.5	66.0	50.0	4500
	130	25	1.5	61.0	46.0	3200
	130	25	1.5	61.0	46.0	3200
	160	37	2.1	113	71.0	2800
80	125	22	1.1	47.5	40.0	3200
	125	22	1.1	47.5	40.0	3200
	140	26	2	71.5	54.5	3000
	170	39	2.1	125	86.5	2600
	170	39	2.1	125	86.5	2600
85	130	22	1.1	47.5	40.0	3000
	150	28	2	84.0	62.0	2800
	180	41	3	102	96.5	2400
	180	41	3	102	96.5	2400
	180	41	3	133	96.5	2400
90	140	24	1.5	58.5	50.0	2800
	160	30	2	97.0	72.0	2600
	190	43	3	144	108	2400
95	145	24	1.5	60.5	54.0	2800
	170	32	2.1	110	80.0	2400

Designations	Abutment and fillet dimensions				Weight
	D _{smin}	D _{smax}	dh _{max}	r _{amax}	
	mm				kg
6313-2RZ	77		128	2	2.360
6014-2RS	76.5		103.5	1	0.623
6214-2RS	78		117	1.5	1.140
180714	78.5		121.5	1.5	2.050
63214X3-2RS	78.5		121.5	1.5	2.050
6314-2RS	81		139	2	2.600
6314-RS	81		139	2	2.620
6314-2RZ	82		138	2	2.600
6015-2RS	81		108.5	1	0.604
6015-2RZ	81		109	1	0.604
6215-2RS	83		122	1.5	1.230
FL-6215-2RS/P6	83		122	1.5	1.230
6215-2RZ	84		121	1.5	1.230
6215-2RS/HAC3V2YA7	84	88	121	1.5	1.180
6315-2RS	87		148	2	3.00
6016-2RS	86.5		118.5	1	0.856
6016-2RZ	86		119	1	0.856
6216-2RS	89		131	2	1.51
6316-RS	91		159	2	3.71
6316-2RS	91		159	2	3.75
6017-2RS	91.5		123.5	1	0.966
6217-2RS	94		141	2	1.81
6317-RS	98		167	2.5	4.32
6317-2RS	98		167	2.5	4.35
6317-2RZ	99		166	2.5	4.35
6018-2RS	98		132	1.5	1.180
6218-2RS	101		149	2	2.25
6318-2RS	104	114	176	2.5	5.10
6019-2RS/C3	102		138	1.5	1.17
6219-2RS	106		159	2	2.69

Deep Groove Ball Bearing(With Seals)

d 95-150 mm

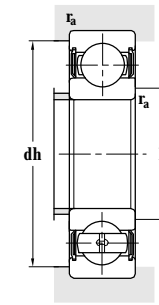
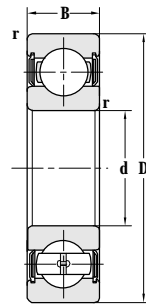
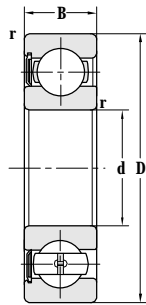

Principal dimensions				Basic load ratings		Limit speed ratings
d	D	B	r _{min}	C _r	C _{or}	Grease
mm				kN		r/min
95	200	45	3	152	118	2400
	200	45	3	152	118	2400
100	150	24	1.5	62.4	52.9	2600
	180	34	2.1	122	93.0	2400
	180	34	2.1	115	88.0	2400
	215	47	3	173	141	2800
105	160	26	2	73.0	62.8	2400
	190	36	2.1	135	102	3200
	225	49	3	240	154	2800
110	140	16	1	26.7	28.2	2600
	170	28	2	82.0	70.6	2400
	200	38	2.1	145	114	3000
	240	50	3	195	167	2600
120	165	22	1.1	48.6	50.5	3900
	180	28	2	85.5	80.0	2200
	215	40	2.1	154	130	2100
	215	40	2.1	155	132	2800
	215	40	2.1	154	130	2800
	260	55	3	217	196	2000
	130	165	18	1.1	33	37.7
200		33	2	109	98	3200
230		40	3	153	134	2600
230		40	3	153	134	2600
140	250	42	3	166	150	2400
	250	42	3	166	150	2400
150	225	35	2.1	123	117	1600
	270	45	3	189	183	2000

Designations	Abutment and fillet dimensions				Weight
	D _{smin}	D _{smax}	dh _{max}	r _{amax}	
	mm				kg
6319-RS	108		187	2.5	5.68
6319-2RS	108		187	2.5	5.92
6020-2RS	108		142	1.5	1.210
6220-2RS	111		169	2	3.270
6220-2RS/CRA9	111		169	2	3.370
6320-2RS	113		202	2.5	7.19
6021-2RS	114		151	2	1.670
6221-2RS	117		178	2	3.870
6321-2RS	119		211	2.5	8.150
61822-2RS2/S3YA7	115		135	1	0.517
6022-2RS	119		161	2	1.98
6222-2RS	122		188	2	4.620
6322-2RS	124		226	2.5	9.770
FL-61924-2RS/P5	126		129	1	1.200
6024-2RS	129		171	2	2.240
6224-2RZ	132		203	2	5.330
6224-2RS/YB2	132		203	2	5.430
6224-2RS	132		203	2	5.330
6324-2RS	134		246	2.5	12.700
FL-61826-2RS/P5	136		159	1	0.816
6026-2RS	139		191	2	3.33
6226-2RZ/Z1	144		216	2.5	6.40
6226-2RS	144		216	2.5	6.40
6228-2RZ/Z1	154		236	2.5	7.52
6228-2RS	154		236	2.5	7.52
6030-2RS	161		214	2	4.050
6230-2RS	164		256	2.5	10.1

Deep Groove Ball Bearing(With Seals)

d 160~190 mm

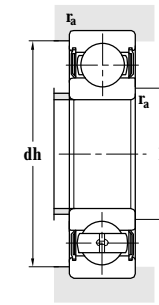
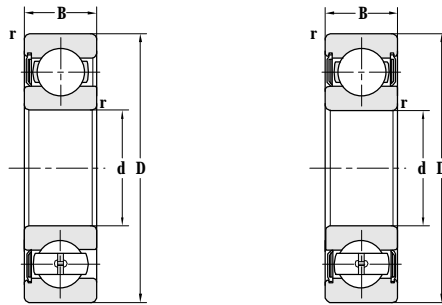

Principal dimensions				Basic load ratings		Limit speed ratings
d	D	B	r _{min}	C _r	C _{or}	Grease
mm				kN		r/min
160	240	38	2.1	143	138	1600
180	320	52	4	240	260	1800
	320	52	4	240	260	1800
190	290	46	2.1	194	204	2000

Designations	Abutment and fillet dimensions				Weight
	D _{smin}	D _{smax}	d _{hmax}	r _{amax}	
	mm				kg
6032-2RS	169		231	2	5.11
6236-2RS 6236-2RZ/Z1	197		303	3	15.0
	197		303	3	15.0
6038-RS	200		280	2	9.13

Deep Groove Ball Bearing (With Seals Wide Inner Ring Bearing)

d 55–600 mm

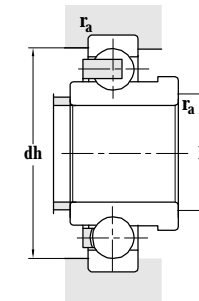
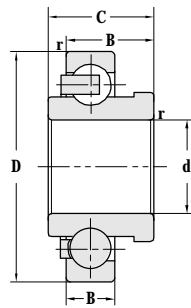

Principal dimensions					Basic load ratings		Limit speed ratings
d	D	B	C	r _{min}	C _r	C _{0r}	Grease
mm					kN		r/min
25	65	18	17	1.1	25.0	13.9	7000
26	68	21.5	14.5	1	31.0	17.0	6500
30	59	13	22	0.4	10	8	11000
	59	13	22	0.4	10	8	11000
32	72	25	19	0.5	26.7	15.0	9000
40	80	27	21	1.1	29.1	17.9	8500
	94	26	31	1.5	41.0	24.0	7500
	100	23	36	2	41.0	24.0	7000
40.5	62	34	12	0.5	11.7	9	9300
45	85	27	21	1.1	29.3	19.5	7500
50	129	27	34	2.5	62.0	38.0	4100
	55	100	55.6	25	1.5	33.5	25.1
	151	33	45	4	55.0	46.0	3600
60	110	65.1	27	1.5	40.5	36	5500
	179	31	45	2.5	63	53	3400
63.5	99.5	29	19.4	1.5	26.5	35.1	4100
76.352	130	33.325	30.15	0.762	66.0	60.0	3000
600	700	100	50	4	260	710	205

Designations	Abutment and fillet dimensions				Weight
	D _{smin}	D _{smax}	d _{hmax}	r _{amax}	
	mm				kg
6605WB1-2RS/P63-SAGW	31		59	1	0.27
6605X2WBTN1/HA	32		62	1	0.272
1-0005	34		55	0.4	0.191
1-0005ZC	34		55	0.4	0.307
66/32WB1-2RSZ/C9	36.5		67.5	0.5	0.408
62208X2WB-2RS/P53	46		74	1	0.525
6308X3WB1TN1-2RS/YA6	48		86	1.5	0.817
6308/YAD	46		91	2	1.36
1-0004	45		57.5	0.5	0.16
62209X2WB-2RS/P53	51		79	1	0.544
CZ5012934-2RS	61		118	2.5	2.09
62211WB-2RSZN	63		92	1.5	1.08
CZ5515145-2RS	71		135	3	3.94
1-0001	68		102	1.5	1.35
CZ6017945-2RS	71		168	2.5	6.1
76TM6429	73		90	1.5	0.603
66/76X4WB1-2RZ/YA3	85		125	0.762	1.46
D66/600	616		684	3	60.6

Deep Groove Ball Bearing (With Snap Groove)

d 20-40 mm

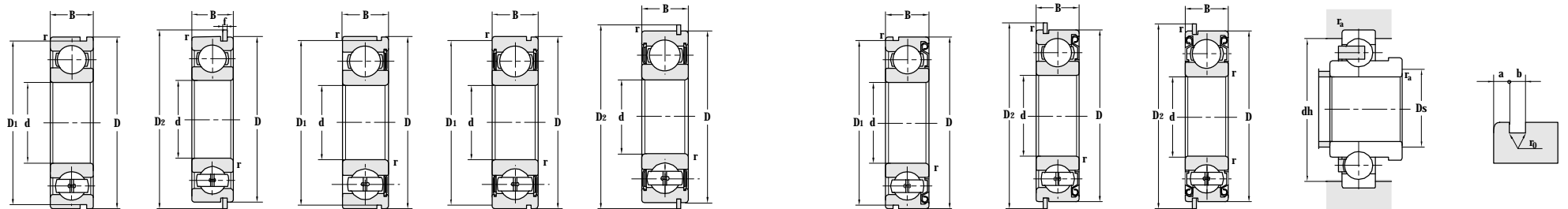

Principal dimensions				Basic load ratings		Snap ring dimensions		Limit speed ratings		
d	D	B	r _{min}	C _r	C _{Or}	D2	f	Grease	Oil	
mm				kN				r/min		
20	47	14	1	13.0	6.70			15000	18000	
25	52	15	1	14.3	8.00	57.9	1.12	12000	15000	
	52	15	1	14.3	8.0			12000	15000	
	52	15	1	14.3	8.00			12000	15000	
	60	19	1.1	21.0	10.8			11000	14000	
	80	21	1.5	37.5	19.0			9000	11000	
35	72	17	1.1	26.0	14.7			9000	11000	
	28	58	16	1	15.6	9.00		11000	14000	
28	68	18	1.1	23.5	13.0			11000	14000	
	30	72	19	1.1	26.7	15.0	78.6	1.7	9000	11000
72		19	1.1	28.4	15.4	9000			11000	
75		20	0.5	32.5	18.0	9000			11000	
75		21	1.5	33.0	17.5	9000			11000	
90		23	1.5	44.5	23.0	8500			10000	
32	75	20	1.5	28.5	16.0			9000	11000	
	75	20	1.5	28.5	16.0			9000	11000	
	80	23	2	36.5	19.6			9000	11000	
	80	23	0.5	36.5	20.0			9000	11000	
	35	62	14	1	16.3	10.5			9000	11000
72		17	1.1	26.0	14.7			9000	11000	
72		17	1.1	26.0	14.7			9000	11000	
72		17	1.1	26.0	14.7			9000	11000	
72		17	2	26.0	15.3	78.1	1.7	9000	11000	
72		17	1.1	26.0	14.7			9000	11000	
80		21	1.5	33.4	19.2			8500	10000	
80		21	1.5	33.4	19.2			8500	1000	
90		21	1.5	37.1	20.7			8500	1000	
100		25	1.5	55.5	29.5	96.5	2.46	8500	7000	
40		68	15	1	16.8	11.6			9500	12000

Designations	Abutment and fillet dimensions				Snap ring groove dimensions			Weight
	D _{bmin}	d _{hmax}	r _{amax}	D _{1max}	a	b	r _{0max}	
	mm							kg
6204N	25	42	1	44.6	2.46	1.35	0.4	0.110
6205N/C3	30	47	1	49.73	2.46	1.35	0.4	0.131
6205N	30	47	1	49.5	2.4	1.5	0.4	0.131
6205-ZNR	30	47	1	49.73	2.46	1.35	0.4	0.136
6305X3WBTDN1-ZN	30	53	1	57.3	2.46	2.16	0.5	0.255
6405N	33	72	1.5	76.81	3.28	1.9	0.6	0.527
6207-2RSN	41.5	65.5	1	68.81	3.28	1.9	0.6	0.298
62/28-ZN	33	53	1	55.6	2.46	1.35	0.4	0.179
63/28-ZN	34	62	1	64.82	3.28	1.9	0.6	0.294
6306-2RZNC4	36.5	65.5	1	68.81	3.205	1.98	0.6	0.340
6306-ZNR	36.5	65.5	1	68.81	3.28	1.9	0.6	0.365
450706K	36.5	68.5	0.5	71.7	3.2	1.9	0.6	0.474
6306X3-2RSN/HAY	36.5	68.5	1.5	71.83	3.25	1.9	0.6	0.477
6406N	38	82	1.5	86.79	3.28	2.7	0.6	0.715
63/32N	38.5	68.5	1.5	71.83	3.28	1.9	0.6	0.391
63/32-2RSN	38.5	68.5	1.5	71.83	3.28	1.9	0.6	0.413
63/32X3-2RSN/HAY	38.5	73.5	2	76.5	4.7	2	0.6	0.534
4507/32KU	38.5	73.5	0.5	76.5	4.7	2	0.6	0.534
6007-RSNB	40	57	1	59.61	2.08	1.9	0.6	0.161
6207-2RSN	41.5	65.5	1	68.81	3.28	1.9	0.6	0.298
6207-XRSN	41.5	65.5	1	68.81	3.28	1.9	0.6	0.294
6207N	41.5	65.5	1	68.81	3.28	1.9	0.6	0.291
6207-2RSNR/P53YAB	41.5	65.5	2	68	3.3	1.9	0.3	0.305
6207NKTN1-2RZ/C3H	41.5	65.5	2	68.81	3.28	1.9	0.6	0.278
6307N	43	72	1.5	76.81	3.28	1.9	0.6	0.443
6307-ZN	43	72	1.5	76.81	3.28	1.9	0.6	0.443
6307X1NR	43	75	1.5	76.81	3.28	1.9	0.6	0.638
6407N	43	92	1.5	96.8	3.25	2.7	0.6	0.901
6008NR	44.6	63.4	1	64.82	2.49	1.9	0.6	0.200

Deep Groove Ball Bearing(With Snap Groove)

d 55-70 mm

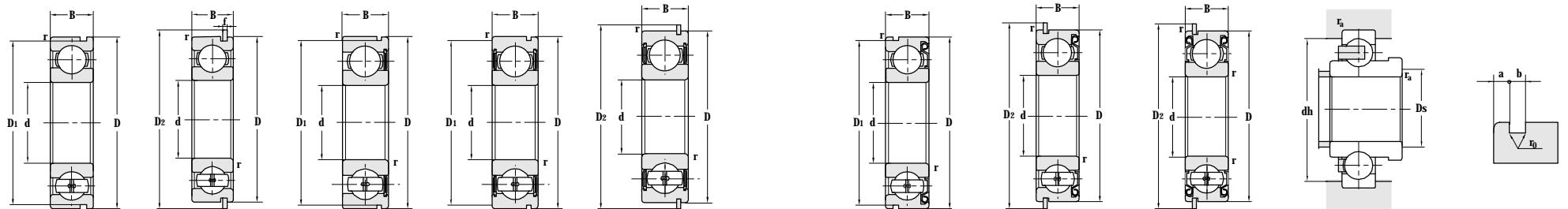

Principal dimensions				Basic load ratings		Snap ring dimensions		Limit speed ratings			
d	D	B	r _{min}	C _r	C _{Or}	D2	f	Grease	Oil		
mm				kN				r/min			
55	100	21	1.5	44.3	27.8	106.5	2.46	6300	7500		
	100	25	1	44.3	27.8			6300	7500		
	120	29	2	71.5	45.0			5600	6700		
	120	29	2	71.5	45.0			5600	6700		
	120	29	2	71.5	45.0			5600	6700		
	120	29	2	71.5	45.0			129.7	2.82	5600	6700
	130	31	1.1	77.0	49.0			139.7	2.77	5300	6400
140	33	2.1	95.0	60.0			5000	6000			
60	110	22	1.5	53.0	36.0	117	2.46	6000	7000		
	110	22	1.5	53.0	36.0			6000	7000		
	110	22	1.5	53.0	36.0			116.6	2.46	6000	7000
	110	22	1.5	53.0	36.0			6000	7000		
	110	22	1.5	53.0	36.0			6000	7000		
	110	22	1.5	53.0	36.0			6000	7000		
	110	22	1.5	53.0	36.0			6000	7000		
	110	22	1.5	53.0	36.0			117	2.46	6000	7000
	110	22	3	53.0	36.0			6000	7000		
	130	31	2.1	82.0	50.0			5000	6000		
	130	31	2.1	82.0	50.0			5000	6000		
	150	35	2.1	107	68.5			4800	5600		
65	100	18	1.1	32.0	25.0	106.5	2.46	6300	7500		
	100	18	1.1	32.0	25.0			6300	7500		
	120	23	1.5	57.0	40.0			5300	6300		
	120	23	1.5	57.0	40.0			5300	6300		
	120	23	3	57.0	40.0			5300	6300		
	140	33	2.1	95.0	59.5			4800	5600		
	140	33	2.1	95.0	59.5			4800	5600		
	140	33	2.1	95.0	59.5			149.7	2.77	4800	5600
	140	33	2.1	95.0	59.5			149.7	2.77	4800	5600
	160	37	2.1	118	78.5			169.7	2.82	4500	5300
70	110	20	1.1	38.0	30.0	116.6	2.46	6000	7000		
	125	24	1.5	61.2	43.2			4800	5800		
	150	35	2.1	107	68.0			4500	5300		
	150	3	2.1	107	68.0			4500	5300		

Designations	Abutment and fillet dimensions				Snap ring groove dimensions			Weight
	D _{bmin}	d _{hmax}	r _{amax}	D _{1max}	a	b	r _{0max}	
	mm							kg
6211-ZNR	63	92	1.5	96.8	3.28	2.7	0.6	0.645
62211WB-2RSZN	63	92	1	96.8	3.28	2.7	0.6	1.08
6311-2ZN	64	111	2	115.21	4.06	3.1	0.6	1.35
6311N	64	111	2	115.21	4.06	3.1	0.6	1.35
6311-2RSN	64	111	2	115.21	4.06	3.1	0.6	1.34
6311-2RSNR	64	111	2	115.21	4.06	3.1	0.6	1.41
6611NR	71	119	1.1	125.3	4.06	3.1	0.6	1.89
6411N	66	129	2	135.23	4.9	3.1	0.6	2.26
6212N	68	102	1.5	106.81	3.28	2.7	0.6	0.778
6212-ZNBR/YB2	68	102	1.5	107	3.28	2.69	0.6	0.794
6212-ZNBR/HAYAB-DC	68	102	1.5	106.81	3.28	2.69	0.6	0.794
6212-ZNB/HAYAB-DC	68	102	1.5	106.81	3.28	2.69	0.6	0.782
6212-ZN	68	102	1.5	106.81	3.28	2.7	0.6	0.766
6212-ZNB/HAYAB	68	102	1.5	106.81	3.28	2.69	0.6	0.782
6212-ZNR	68	102	1.5	107	3.28	2.69	0.6	0.778
6212N-FST	68	102	1.5	106.81	3.28	2.7	0.6	0.778
6312N	71	119	2	125.22	4.06	3.1	0.6	1.72
6312-ZN	71	119	2	125.22	4.06	3.1	0.6	1.73
6412N	71	139	2	145.24	4.9	3.1	0.6	2.7
6013NR	71.5	93.5	1	96.8	2.87	2.7	0.6	0.435
6013N	71.5	93.5	1	96.8	2.87	2.7	0.6	0.414
50213K	73	112	1.5	115.21	4.06	3.1	0.6	1.00
6213N	73	112	1.5	115.21	4.06	3.1	0.6	1.04
6213N-FST	73	112	1.5	115.21	4.06	3.1	0.6	1.04
6313N	76	129	2	135.23	4.9	3.1	0.6	2.13
6313N/YAB-FST	76	129	2	135.23	4.9	3.1	0.6	2.13
6313NR/C3YA6	76	129	2	135.23	4.9	3.1	0.6	2.17
6313NR/C3	76	129	2	135.23	4.9	3.1	0.6	2.20
6413NR/C3	76	149	2	155.22	4.9	3.1	0.6	3.26
6014NR	76.5	103.5	1	106.81	2.87	2.7	0.6	0.648
6214N	78	117	1.5	120.22	4.06	3.1	0.6	1.10
6314N	81	139	2	145.24	4.9	3.1	0.6	2.54
6314N/YA6	81	139	2	145.24	4.9	3.1	0.6	2.54

Deep Groove Ball Bearing (With Snap Groove)

d 70-105 mm

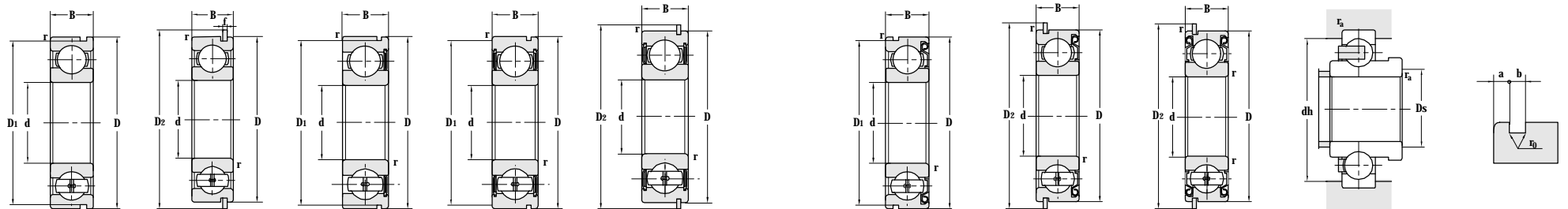

Principal dimensions				Basic load ratings		Snap ring dimensions		Limit speed ratings	
d	D	B	r _{min}	C _r	C _{Or}	D2	f	Grease	Oil
mm				kN				r/min	
70	150	35	2.1	107	68.0	159.7	2.82	4500	5300
	150	35	2.1	107	68.0			4500	5300
	150	35	2.1	136	102			4500	5300
	150	35	2.1	136	102			4500	5300
75	115	20	1.1	40.0	32.2	169.7	2.82	5600	6700
	130	25	1.5	66.0	50.0			4800	5600
	160	37	2.1	113	77			4300	5000
	160	37	2.1	149	115			4500	5200
	160	37	2.1	149	115			4500	5200
80	140	26	2	71.5	54.5	139.7	2.82	4500	5300
	170	39	2.1	125	86.5			4000	4800
	200	48	3	160	122			3400	4000
85	130	22	1.1	47.5	40.0	149.7	2.82	5000	6000
	130	22	1.1	47.5	40.0			5000	6000
	150	28	2	84.0	62.0			4300	5000
	150	28	2	84.0	62.0			4300	5000
	180	41	3	102	96.5			3800	4500
	160	30	2	83.0	64.5			4300	5000
90	140	24	1.5	58.5	50.0	149.7	2.82	4800	5600
	140	24	1.5	61.0	51.0			4800	5600
	140	24	1.5	55.5	45.0			4800	5600
	140	24	1.5	63.5	51.0			4800	5600
	140	24	1.5	63.5	51.0			4800	5600
	140	24	1.5	58.5	50.0			4800	5600
	140	24	1.5	58.5	50.0			4800	5600
	160	30	2	97.0	72.0			3800	4500
	160	30	2	96.0	71.5			3800	4500
	190	43	3	144	108			3000	3800
95	200	45	3	152	118			2800	3600
100	250	58	4	214	184			2600	3400
	150	24	1.5	62.4	52.9			4300	5000
105	190	36	2.1	135	102			3200	3800

Designations	Abutment and fillet dimensions				Snap ring groove dimensions			Weight
	D _{bmin}	d _{hmax}	r _{amax}	D _{1max}	a	b	r _{0max}	
	mm							kg
6314NR/C3	81	139	2	145.24	4.9	3.1	0.6	2.62
6314N/C9	81	139	2	145.24	4.9	3.1	0.6	2.54
314MN	81	139	2	145.24	4.9	3.1	0.6	3.18
314N/YAD	81	139	2	145.24	4.9	3.1	0.6	2.92
6015N-FST	81.5	108.5	1	111.81	2.87	2.7	0.6	0.622
6215N	83	122	1.5	125.2	4.05	3.1	0.6	1.18
6315N	86	149	2	155.22	4.9	3.1	0.6	2.92
315NR/YA8-1	86	149	2.1	155.22	4.9	3.1	0.6	4.27
315NR/YA68-1	86	149	2.1	155.22	4.9	3.1	0.6	4.27
6216N	89	131	2	135.23	4.9	3.1	0.6	1.46
6316N	91	159	2	163.65	5.69	3.5	0.6	3.63
6416N	93	187	2.5	193.6	5.7	3.5	0.6	6.78
6017NR/YB2	91.5	123.5	1	125.22	4.06	3.1	0.6	0.981
6017N/YB2-FST	91.5	123.5	1	125.22	4.06	3.1	0.6	0.903
6217N	94	141	2	145.2	4.9	3.1	0.6	1.82
6217-ZN	94	141	2	145.24	4.9	3.1	0.6	1.82
6317N	98	167	2.5	173.66	5.69	3.5	0.6	4.23
6317X3N	96	145	2	155.22	4.9	3.1	0.6	2.44
6018N	98	132	1.5	135.23	3.71	3.1	0.6	1.15
6018N/HAYAB	98	132	1.5	135.23	3.71	3.1	0.6	1.12
6018N/YAB-1	98	132	1.5	135.23	3.71	3.1	0.6	1.15
6018N/YAD	98	132	1.5	135.23	3.71	3.1	0.6	1.11
6018NR/YAD	98	132	1.5	135.23	3.71	3.1	0.6	1.18
6018NR/YAB-2	98	132	1.5	135.23	3.71	3.1	0.6	1.22
6018NR/YAB-2-DC	98	132	1.5	135.23	3.71	3.1	0.6	1.22
6218N	99	151	2	155.22	4.9	3.1	0.6	2.18
6218NR/YA7	99	151	2	155.22	4.9	3.1	0.6	2.3
6318N	100	180	2.5	183.64	5.69	3.5	0.6	4.73
6319N	110	185	2.5	193.65	5.69	3.5	0.6	5.79
6420N	116	234	3	242	6.5	4.5	0.6	13.1
6020N	108	142	1.5	145.24	3.71	3.1	0.6	1.13
6221N	116	179	2	183.6	5.7	3.5	0.6	3.79

Deep Groove Ball Bearing(Full Elements)



d 50–440 mm

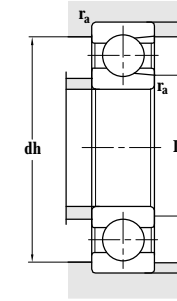
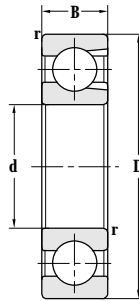

Principal dimensions				Basic load ratings		Limit speed ratings	
d	D	B	r _{min}	C _r	C _{or}	Grease	Oil
mm				kN		r/min	
50	110	27	2	85.5	62.0	4500	6300
60	130	31	2.1	113	83.5	3800	5300
65	140	33	2.1	130	90.0	3400	4800
70	125 150	24 35	1.5 2.1	84.5 163	73 110	4800 3200	5800 4500
75	160	37	2.1	204	125	3000	4300
107	145	16	1.3	52.0	66.0	1500	1900
170	260	42	3.5	206	294	1200	1500
220	270 300	24 38	1.5 2.1	99.0 201	161 292	1100 1000	1300 1300
240	300	28	2	142	212	1000	1300
320	412	38	2.5	319	530	900	1100
340	460	56	3	420	740	850	1000
440	600	74	4	730	1170	800	950

Designations	Abutment and fillet dimensions			Weight
	D _{smin}	d _{hmax}	r _{amax}	
	mm			kg
310V	59	101	2	1.01
312V	71	119	2	1.82
313V	76	129	2	2.15
214V	78	117	1.5	1.19
314V	81	139	2	2.65
315V/C9	86	149	2	3.23
970921	114.6	137.4	1.3	0.821
6034V/YA7	182	248	3.5	7.11
61844V	228	262	1.5	2.62
61944V	231	289	2	7.24
61848V	249	291	2	4.93
970864	332	400	2.5	11.8
61968V	353	447	2.5	25.6
61988V	456	584	3	55.6

Deep Groove Ball Bearing(With Filling Slot)

d 30~165 mm

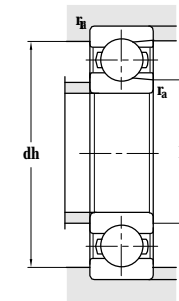
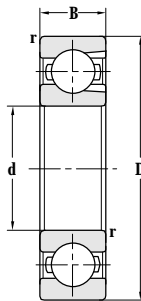

Principal dimensions				Basic load ratings		Limit speed ratings	
d	D	B	r _{min}	C _r	C _{0r}	Grease	Oil
mm				kN		r/min	
30	62	16	1	23.6	16.0	10000	13000
43	100	25	1.5	65.0	43.5	5200	6600
	100	25	1.5	65.0	43.5	5200	6600
45	85	19	1.1	43.0	32.0	5300	7500
	100	25	1.5	65.0	43.5	5200	6600
50	90	20	1	40.0	31.0	5300	6700
	110	27	1.5	80.0	57.0	4500	6300
55	140	33	2.1	97.5	89.0	3800	4800
65	120	23	1.5	78.0	64.0	4300	6000
	120	23	1.5	59.2	57.3	4300	6000
	140	33	2.1	110	90.0	3400	4800
70	125	24	1.5	84.5	73.0	4000	5000
	130	25	1.5	84.5	74.5	3400	4800
	180	42	3	133	136	2700	3500
	180	42	3	140	148	2700	3500
85	160	37	2.1	157	125	3000	3700
	180	41	3	183	157	3800	4500
90	190	43	3	144	108	3400	4000
107	147	16	1.3	40.0	70.0	2700	3400
165	250.5	35	2.5	187	204	1200	1500

Designations	Abutment and fillet dimensions			Weight
	D _{smin}	dh _{max}	r _{amax}	
	mm			kg
206	35	57	1	0.217
30/43NR 30/43NR-2Z/YAD	52.5	90.5	1.5	0.949
	52.5	90.5	1.5	0.994
209 309/YA8	51.5	78.5	1	0.492
	52.5	90.5	1.5	0.920
210-Z/YA6 310	56	84	1	0.503
	59	101	2	1.10
411N1/YB8	66	129	2	2.45
370213	73	112	1.5	1.01
213	73	112	1.5	1.01
313	76	129	2	2.4
214V	78	117	1.5	1.19
215	83	122	1.5	1.32
414N1-RS	83	167	3	4.04
414N1-Z/YB8	83	167	3	5.64
315V/C9 6317V	86	149	2	3.23
	98	167	2.5	4.16
6318V	103	177	2.5	4.84
66/107V	115	140	1.3	0.821
370833	177	239	2.5	6.56

Angular Contact Ball Bearing

Raceway of inner ring and outer ring of angular contact ball bearing can displace relatively on the same horizontal axis, so this design can withstand the combined loads that is made up of axial and radial load at the same time.

Axial load carrying capacity of angular contact ball bearing increases when increasing the contact angle. The definition of contact angle is the angle between wired connecting balls with raceway and vertical axis of bearing on radial plane. When carry loads, it passed one

raceway to another along the wired between balls and raceway.

ZWZ can provide various kinds of contact ball bearing in different size

Single-row angular contact ball bearing (See Figure 1)

Four-point contact ball bearing (See Figure 2)

Double-row angular contact ball bearing (See Figure 3 and Figure 4)

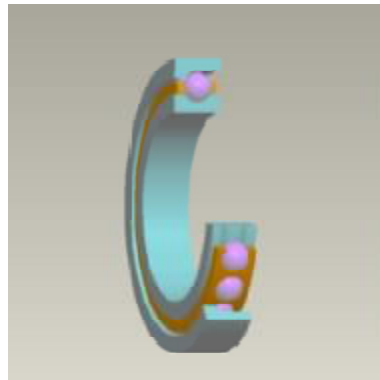

Figure 1

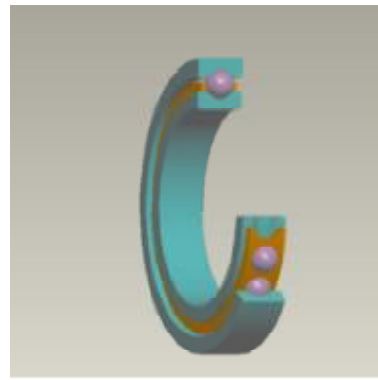

Figure 2

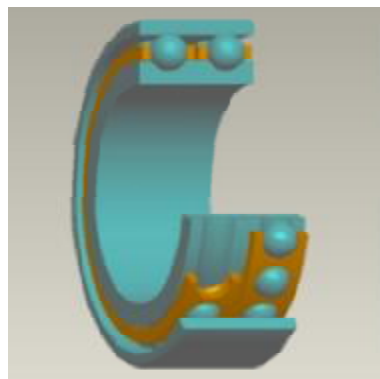

Figure 3

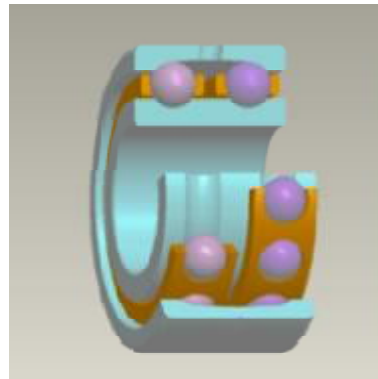

Figure 4

Design:

Single-row Angular Contact Ball Bearing

Single-row angular contact ball bearing consists of one outer ring, one inner ring, one-row steel balls and a cage. The bearings can carry radial load and axial load simultaneously. They can also bear even pure axial load and work at higher rotational speed. However, this bearing can only carry axial load in one direction. When it carry radial load, an additional axial force will occur and can only limit the axial displacement of shaft and housing in one direction. Although this bearing can only carry axial load in one direction, it can be mounted with the other bearing carrying a load in contrary direction. If paired mounting, make the end faces of outer rings of two bearings face to face, i.e. wide end face to wide end face (DB type) and narrow end face to narrow end face (DF type). This arrangement can avoid the occurrence of additional axial force and limit the movement of shaft and housing within axial clearance range of bearing in two directions.

Single-row angular contact ball bearing has more balls than those of deep groove ball bearing with the same boundary dimensions and therefore this kind of bearing has the highest load rating among ball bearings, strong rigidity and steady operation. The radial clearance can be adjusted by the relative displacement of inner ring and outer ring. The rigidity of system can be improved by the pre-interference amount generated by placing several bearings in tandem arrangement.

Angular contact ball bearing can not be separated and has poor self-aligning property. The contact angle of this bearing is not zero.

The contact angle of single-row angular contact ball bearing is 15°, 25°, 30° and 40°. Contact angle determines how big radial load and axial load the bearing can carry when operating. The bigger the contact angle is, the bigger axial load capacity will be. But the smaller contact angle is positive to high speed rotation. Single-row angular contact ball bearing doesn't have clearance. Internal clearance can only be achieved through stack mounting. According to applications, the stack mounting bearings have two types, which are preloaded or have pre-clearance. The internal clearance of preloaded stack mounting bearings is zero or negative. This bearing is often used on main shaft of machine tool to improve the rigidity and rotational precision of main shaft. The clearance or preload of matched pair bearing has been set in ZWZ and it is unnecessary for customer to adjust. The width tolerance and end surface convexity of an individual single-row angular contact ball bearing is produced as per normal class so these bearings can not be stack-mounted in random.

ZWZ can also produce universal stack mounting angular-contact ball bearings with DB, DF or in tandem arrangement. The universal stack mounting bearings have two types, which are preloaded or have pre-clearance. Except universal stack mounting bearings, all individual bearings of other kinds of stack mounting bearings are not interchangeable.

This bearing is most used in the applications with high rotation speed, high precision and small axial load such as main shaft of motor of airplane, main shaft of machine tool and other main shafts of high speed and precision machinery. It is also used on high frequency

Angular Contact Ball Bearing

motor, gas turbine, oil pump, air compressor, printing machines etc. It's a most widely used bearing in machinery industry.

Double-row Angular Contact Ball Bearing

Design of ZWZ double-row angular contact ball bearing is basically the same with single-row ball bearing, but it only takes less axial space. Double-row angular contact ball bearing can carry radial loads and radial loads from two directions. bearing device with high rigidity can be provided and withstand capsizing moment.

Single-row angular contact ball bearing and stack mounting angular contact ball bearing

In order to improve the rigidity and load-carry property, the same angular contact ball bearings are often stack mounted in twosome (DB, DF, DT), triplet (TBT, TFT, TT), quaternion (QBC, QFC, QT) and even quintuplet (PBC, PFC, PT, PBT, PFT). For twosome bearings, the type of matched pair can be back to back (DB), face to face (DF) and tandem (DT).

Stack mounting bearings in DB type is suitable for carrying individual or combined radial load and axial load. These bearings can also carry axial loads in two directions, larger tilting moment and have strong rigidity. These bearings can be preloaded properly according to working conditions.

While Stack mounting bearings in DF type can only carry smaller tilting moment and provide inferior system rigidity. But the advantage of these bearings is less sensible to concentricity error of bearing housing.

Stack mounting bearings in tandem arrangement can only carry a larger axial load

in one direction. In most occasions, these bearings need to be preloaded by spring and the preload value is associated with the value of radial load carried and bearing rigidity.

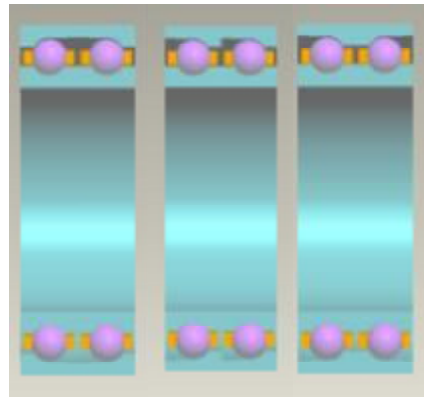

Double-row angular contact ball bearings produced by ZWZ have three kinds of combination way as below:

1. 0000/DC Type, which is made up of two-raceway inner ring and two single-raceway outer ring



Angle of this kind of bearing is 40° to carry big radial load, axial load and combined load

from radial and axial direction, mainly used in the components limiting axial displacement of the shaft or housing, with a high limiting rotation speed.

2. 0000D Type, which is made up of two-raceway outer ring and two single-raceway inner ring



Original code is 86000 type. Angle of this kind of bearing is 45° , as well as 26° , 32° and 40° in special situation. It is used to withstand big radial load, axial load and combined load from radial and axial direction, mainly used in the components limiting axial displacement of the shaft or housing, with a high limiting rotation speed.

3. 0000(α=30°)0000A Type, which is made up of two-raceway outer ring and two double-raceway inner ring



Original code is 56000 Type. Angle of this kind of bearing is 30° , as well as 26° , 32° and 40° in special situation. The structure is basically the same as two paired back to back angular contact ball bearings, with smaller width than that of paired bearing. It can carry big combined load from axial and radial direction, as well as a certain axial load from one direction. It can endure big capsizing moment. It is mainly applied in the components limiting axial displacement of the shaft or housing, with a high limiting rotation speed. Generally, there is a filling slot on one end. The cage uses copper cage. When the suffix code contains TN, the cage is made up of nylon, the ring without filling slot and can carry equal axial load from two directions.

Common Information and Data Dimension

Basic dimension of ZWZ angular contact ball bearing has been listed in the dimension data table

Angular Contact Ball Bearing

Single-row angular contact ball bearing

ID dimension range: 25mm~1180mm
 OD dimension range: 62mm~1420mm
 Width dimension range: 16mm~106mm

Stack mounting angular contact ball bearing

ID dimension range: 30mm~1320mm
 OD dimension range: 62mm~1600mm
 Width dimension range: 32mm~244mm

Double-row angular contact ball bearing

ID dimension range: 35mm~320mm
 OD dimension range: 72mm~460mm
 Width dimension range: 27mm~160mm

Tolerance

The standard tolerance of Single-row angular-contact ball bearing manufactured by Class P0 but ZWZ can also supply the bearings meeting precision Class P6 or higher. For a single bearing with contact angle (α) of 15° and 25° used for paired mounting, the precision class meets P5. For a single bearing with contact angle (α) of 40° used for paired mounting, the precision class meets P6. ZWZ also can supply the bearings with precision 4A, 2A or other precision requirement. Please refer to standard tolerances listed in the table of preface pages.

Internal Clearance and Preload

Single-row angular contact ball bearing can reach a certain internal clearance only after mounting, and it depends on another bearing adjustment used for axial location of supplying contrary direction.

ZWZ stack mounting bearings are divided into preload and preclearance.

Preload

GA——Light preload
 GB——Medium preload
 GC——Heavy preload

Preclearance

CA——Small axial clearance
 CB——Medium axial clearance
 CC——Big axial clearance

Preload

The preload values (Unit:μm) of DB or DF matched pair bearings are listed in below table:

Contact angle 15°

ID code	(B)71900C			(B)7000C			(B)7200C		
	A	B	C	A	B	C	A	B	C
00	10	20	40	15	30	60	20	40	80
01	10	20	40	15	30	60	20	40	80
02	15	30	60	20	40	80	30	60	120
03	15	30	60	25	50	100	35	70	140
04	25	50	100	35	70	140	45	90	180
05	25	50	100	35	70	140	50	100	200
06	25	50	100	50	100	200	90	180	360
07	35	70	140	60	120	240	120	240	480
08	45	90	180	60	120	240	150	300	600
09	50	100	200	110	220	440	160	320	640
10	50	100	200	110	220	440	170	340	680
11	70	140	280	150	300	600	210	420	840
12	70	140	280	150	300	600	250	500	1000
13	80	160	320	160	320	640	290	580	1160
14	130	260	520	200	400	800	300	600	1200
15	130	260	520	200	400	800	310	620	1240
16	140	280	560	240	480	960	370	740	1480
17	170	340	680	250	500	1000	370	740	1480
18	180	360	720	300	600	1200	480	960	1920
19	190	380	760	310	620	1240	520	1040	2080
20	230	460	920	310	620	1240	590	1180	2360
21	230	460	920	360	720	1440	650	1300	2600
22	230	460	920	420	840	1680	670	1340	2680
24	290	580	1160	430	860	1720	750	1500	3000
26	350	700	1400	560	1120	2240	800	1600	3200
28	360	720	1440	570	1140	2280			
30	470	940	1880	650	1300	2600			
32	490	980	1960	730	1460	2920			
34	500	1000	2000	800	1600	3200			
36	630	1260	2520	900	1800	3600			
38	640	1280	2560	950	1900	3800			
40	800	1600	3200	1100	2200	4400			
44	850	1700	3400	1250	2500	5000			
48	-	-	-	1300	2600	5200			

Angular Contact Ball Bearing

Contact angle 25° , Contact angle 40°

ID code	(B)71900C			(B)7000AC			(B)7200AC			7200B、7300B		
	A	B	C	A	B	C	A	B	C	A	B	C
00	15	30	60	25	50	100	35	70	140	80	330	660
01	15	30	60	25	50	100	35	70	140	80	330	660
02	25	50	100	30	60	120	45	90	180	80	330	660
03	25	50	100	40	80	160	60	120	240	80	330	660
04	35	70	140	50	100	200	70	140	280	120	480	970
05	40	80	160	60	120	240	80	160	320	120	480	970
06	40	80	160	90	180	360	150	300	600	120	480	970
07	60	120	240	90	180	360	190	380	760	160	630	1280
08	70	140	280	100	200	400	240	480	960	160	630	1280
09	80	160	320	170	340	680	260	520	1040	160	630	1280
10	80	160	320	180	360	720	260	520	1040	160	630	1280
11	120	240	480	230	460	920	330	660	1320	380	1500	3050
12	120	240	480	240	480	960	400	800	1600	380	1500	3050
13	120	240	480	240	480	960	450	900	1800	380	1500	3050
14	200	400	800	300	600	1200	480	960	1920	380	1500	3050
15	210	420	840	310	620	1240	500	1000	2000	380	1500	3050
16	220	440	880	390	780	1560	580	1160	2320	380	1500	3050
17	270	540	1080	400	800	1600	600	1200	2400	410	1600	3250
18	280	560	1120	460	920	1840	750	1500	3000	410	1600	3250
19	290	580	1160	480	960	1920	850	1700	3400	410	1600	3250
20	360	720	1440	500	1000	2000	950	1900	3800	410	1600	3250
21	360	720	1440	560	1120	2240	1000	2000	4000	410	1600	3250
22	370	740	1480	650	1300	2600	1050	2100	4200	410	1600	3250
24	450	900	1800	690	1380	2760	1200	2400	4800	410	1600	3250
26	540	1080	2160	900	1800	3600	1250	2500	5000	540	2150	4300
28	560	1120	2240	900	1800	3600				540	2150	4300
30	740	1480	2960	1000	2000	4000				540	2150	4300
32	800	1600	3200	1150	2300	4600				540	2150	4300
34	800	1600	3200	1250	2500	5000				540	2150	4300
36	1000	2000	4000	1450	2900	5800				540	2150	4300
38	1000	2000	4000	1450	2900	5800				940	3700	7500
40	1250	2500	5000	1750	3500	7000				940	3700	7500
44	1300	2600	5200	2000	4000	8000				940	3700	7500
48				2050	4100	8200				940	3700	7500

For multi-stacking mounting bearings that consist of three or more than three sets of bearing, the preload values are the number of following coefficient multiplied by the preload value of DB or DF matched pair bearings.

Stack mounting type		Coefficient
TBT	TFT	1.35
QBT	QFT	1.60
QBC	QFC	2
DBT	DFT	1.75
PBC	PFC	2.45

Pre-clearance

Axial pre-clearance values (Unit:μm) of 7200B series and 7300B series matched pair bearings (DB or DF type) are listed as below:

d mm	CA		CB		CC		
	min	max	min	max	min	max	
Over	To						
-	10	4	12	14	22	22	30
10	18	5	13	15	23	24	32
18	30	7	15	18	26	32	40
30	50	9	17	22	30	40	48
50	80	11	23	26	38	48	60
80	120	14	26	32	44	55	67
120	180	17	29	35	47	62	74
180	250	21	37	45	61	74	90

Error of Centralization

For single-row angular contact ball bearing, ability of allowing angle error is limited. When it can not cause over additional stress to bearing, the angle error allowed by inner and outer ring depends on the radial clearance, bearing dimension, internal design, force and moment acted on bearing during bearing running. Due to the complicated relations among these factors, a specific common value can not be supplied. The paired bearing, especially for bearing pack that is mounted back to back with small axial clearance, when angle error existing in inner and outer ring, it will cause the balls carry bigger load. As a result, increase the stress on the cage and shorten bearing service life. Any angle error can lead to increase of noise. When angle error existing in inner and outer ring of double-row angular contact ball bearing, it will cause bigger load acted on balls and raceway. Any angle error can induce noise increasing and shortening bearing service life.

Cage

Self-aligning ball bearing has stamped steel cage, solid brass cage and nylon cage. The material of cage is sheet steel, brass and synthetic resin.

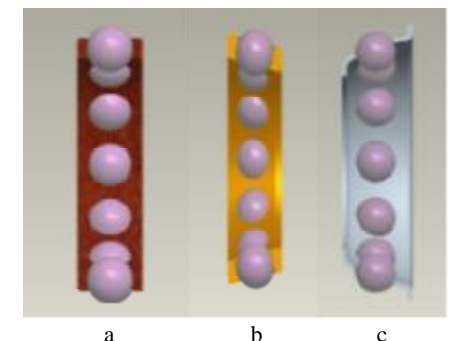

Angular Contact Ball Bearing

Four-point angular contact bearing has solid brass cage without suffix after basic bearing number.

For a single bearing, the bearings in matched pair: when outside diameter is less than 250mm and contact angle is 15° and 25°, the material of cage is cotton fabric phenolic laminate. When outside diameter is more than 250mm, the material of cage is solid brass or hard aluminum.

Cotton fabric phenolic laminate cage is adopted for the bearings meeting precision P5, P4 and P2. And there is no suffix following basic bearing number.

Cotton fabric phenolic laminate cage is also adopted for Angular contact ball bearings with locking slot on inner ring or any changed bearings based on them. And there is no suffix following basic bearing number.

Stamped sheet (strip) steel cage is adopted for Double-row angular contact ball bearings and there is no suffix following basic bearing number.

The bearing with nylon cage can operate under ambient temperature of 120 or higher. The solid brass cage is considered when the bearing is used under high temperature or critical conditions.

Please contact ZWZ in advance if requesting for the bearing with non-standard cage.

Dynamic Equivalent Load

Single-row angular contact ball bearing with contact angle of 15°

Single bearing or two bearings in tandem arrangement

$$P=Fr \quad [kN] \quad \text{When } Fa/Fr \leq e$$

$$P=0.44Fr+YFa \quad [kN] \quad \text{When } Fa/Fr > e$$

Two bearings in back-to-back arrangement or face-to-face arrangement

$$P=Fr +Y1Fa \quad [kN] \quad \text{When } Fa/Fr \leq e$$

$$P=0.72Fr+Y2Fa \quad [kN] \quad \text{When } Fa/Fr > e$$

The values of e, Y, Y1 and Y2 are as follows:

Fa/C0	e	Y	Y1	Y2
0.015	0.38	1.47	1.65	2.39
0.029	0.40	1.40	1.57	2.28
0.058	0.43	1.30	1.46	2.11
0.087	0.46	1.23	1.38	2.00
0.12	0.47	1.19	1.34	1.93
0.17	0.50	1.12	1.26	1.82
0.29	0.55	1.02	1.14	1.66
0.44	0.56	1.00	1.12	1.63
0.58	0.56	1.00	1.12	1.63

Note: C0 is basic static load rating of a single bearing.

Single-row angular contact ball bearing with contact angle of 25°

Single bearing or two bearings in tandem arrangement

$$P=Fr \quad [kN] \quad \text{When } Fa/Fr \leq 0.68$$

$$P=0.41Fr+0.87Fa \quad [kN] \quad \text{When } Fa/Fr > 0.68$$

Two bearings in back-to-back arrangement or face-to-face arrangement

$$P=Fr+0.92Fa \quad [kN] \quad \text{When } Fa/Fr \leq 0.68$$

$$P=0.67Fr+1.41Fa \quad [kN] \quad \text{When } Fa/Fr > 0.68$$

Single-row angular contact ball bearing with contact angle of 40°

Single bearing or two bearings in tandem arrangement

$$P=Fr \quad [kN] \quad \text{When } Fa/Fr \leq 1.14$$

$$P=0.35Fr+0.57Fa \quad [kN] \quad \text{When } Fa/Fr > 1.14$$

Two bearings in back-to-back arrangement or face-to-face arrangement

$$P=Fr +0.55Fa \quad [kN] \quad \text{When } Fa/Fr \leq 1.14$$

$$P=0.57Fr+0.93Fa \quad [kN] \quad \text{When } Fa/Fr > 1.14$$

Double-row angular contact ball bearing

When contact angle is 30°

$$P=Fr +0.78 Fa \quad [kN] \quad \text{When } Fa/Fr \leq 0.8$$

$$P=0.63Fr+1.24Fa \quad [kN] \quad \text{When } Fa/Fr > 0.8$$

When contact angle is 45°

$$P=Fr +0.47Fa \quad [kN] \quad \text{When } Fa/Fr \leq 1.34$$

$$P=0.54Fr+0.81Fa \quad [kN] \quad \text{When } Fa/Fr > 1.34$$

Static Equivalent Load

Single-row angular contact ball bearing with contact angle of 15°

$$P0=0.5Fr +0.46Fa \quad [kN]$$

$$\text{When } F0 < Fr \quad \text{Choose } P0 = Fr$$

Two bearings in back-to-back arrangement or face-to-face arrangement

$$P0=Fr +0.92Fa \quad [kN]$$

Single-row angular contact ball bearing with contact angle of 25°

Single bearing or two bearings in tandem arrangement

$$P0=0.5Fr +0.38Fa \quad [kN]$$

$$\text{When } F0 < Fr \quad \text{Choose } P0 = Fr$$

Two bearings in back-to-back arrangement or face-to-face arrangement

$$P0=Fr+0.76Fa \quad [kN]$$

Single-row angular contact ball bearing with contact angle of 40°

Single bearing or two bearings in tandem arrangement

$$P0=0.5Fr +0.26Fa \quad [kN]$$

$$\text{When } F0 < Fr \quad \text{Choose } P0 = Fr$$

Two bearings in back-to-back arrangement or face-to-face arrangement

$$P0=Fr+0.52Fa \quad [kN]$$

Double-row angular contact ball bearing

When contact angle is 30°

$$P0=Fr+0.66Fa \quad [kN]$$

When contact angle is 45°

$$P0=Fr+0.44Fa \quad [kN]$$

Supplement Code

A Contact angle is 30°

AC Contact angle is 25°

B Contact angle is 40°

C Contact angle is 15°

C1 Clearance conforms to Group 1 specified in standard clearance

C2 Clearance conforms to Group 2 specified in standard clearance

C3 Clearance conforms to Group 3 specified in standard clearance

C4 Clearance conforms to Group 3 specified in standard clearance

C9 Clearance is different from current standard

When there are two or more than two clearance is different from current standard clearance in uniform code, use attached digits

CA Axial clearance is small

CB Axial clearance is bigger than CA

CC Axial clearance is bigger than CB

CX Axial clearance is nonstandard

D Double-row angular contact ball bearing, double inner rings, contact angle is 45°

DC Double-row angular contact ball bearing, double inner rings

DB Two angular contact ball bearings used in back to back paired mounting

DF Two angular contact ball bearings used in face to face paired mounting

DT Two angular contact ball bearings used in tandem arrangement

DBA Two angular contact ball bearings used in back to back paired mounting, light preload

DBAX Two angular contact ball bearings used in back to back paired mounting, nonstandard light preload

DBB Two angular contact ball bearings used in back to back paired mounting, medium preload

DBBX Two angular contact ball bearings used in back to back paired mounting nonstandard medium preload

DFA Two angular contact ball bearings used in face to face paired mounting, light preload

DTA Two angular contact ball bearings used in tandem arrangement in the same direction, light preload

F1 Carbon steel solid cage

F3 Nodular cast iron solid cage

GA Light preload, preload value is small

HA Ring, rolling element and cage or only the ring and cage is made up of vacuum smelting bearing steel

J Pressed-sheet steel cage, attach digits to tell when material changes

K Bearing with taper hole, taper of 1:12

L3 Aluminium and zinc alloy solid cage

M Bronze solid cage

N1 Bearing outer ring with a positioning notch

P4 Dimensional precision and rotational precision conform to ISO tolerance level 4

P4A Tolerance level is higher than P4

P5 Dimensional precision and rotational precision conform to ISO tolerance level 5

Q1 Aluminium, Fe and Mn bronze solid cage

Q5 Tin-bronze solid cage

RS Bearing with skeleton-type rubber sealing ring on one side (contact type)

2RS Bearing with RS shield on two sides

S0 Bearing ring after high-temperature tempering, the working temperature reaches 150°C

T Phenolic cloth laminated tube solid cage

TA Phenolic cloth laminated tube solid cage, guided with outer ring

TN1 Nylon cage

TYN Polyamide resin cage

V1 Speed conforms to V1 group as specified in standard

W33 Oil groove and three lubrication holes on the outer ring

W33A Oil groove and four lubrication holes on the outer ring

X1 Outer diameter is nonstandard

X2 Width (height) is nonstandard

X3 Outer diameter and width (height) are nonstandard (standard inner diameter)

YA1 Outside surface of bearing outer ring is different from standard design

YA3 End face of bearing ring is different from standard design

YA6 Mounting chamfer of bearing is different from standard design

YA8 Cage structure changes

YB2 Dimension and tolerance of bearing change

Single-row Angular Contact Ball Bearing

d 25-40 mm

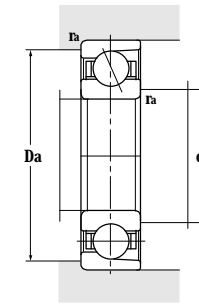
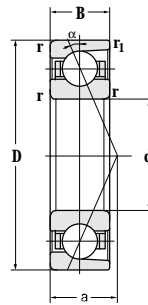

Principal dimensions					Basic load ratings		Limit speed ratings	
d	D	B	r	r ₁	C _r	C _{or}	Grease	Oil
mm					kN		r/min	
25	47	12	0.6	0.3	11.1	8.1	10000	15000
	52	15	1	1	15.9	9.6	10000	15000
	62	17	1.1	0.6	28.6	16.0	10000	15000
	62	17	1.1	0.6	24.7	14.0	9000	13000
30	55	13	1	1	14.3	10.0	1000	13000
	62	16	1.1	0.3	21.0	14.0	8500	12000
	72	19	1.1	0.6	31.8	21.0	8500	13000
	72	19	1.1	0.6	31.0	19.5	8000	11000
	72	19	1.1	0.6	33.6	18.0	8000	11000
35	72	17	1.1	1.1	30.5	20.7	8000	11000
	72	17	1.1	0.6	32.5	22.0	9000	12000
	72	17	1.1	0.6	27.0	19.0	8000	11000
	72	17	1.1	0.6	29.0	18.0	8000	11000
	80	21	1.5	0.6	40.3	26.0	8000	11000
35	80	21	1.5	0.6	39.0	25.0	7800	10500
	80	21	1.5	0.6	39.0	25.0	7500	10000
	80	21	1.5	0.6	39.0	25.0	6000	8000
	100	25	1.5	0.6	70.2	42.0	6300	8000
	100	25	1.5	0.6	70	42.0	6000	8000
40	68	15	1	1	20.5	15.9	8300	11000
	80	18	1.1	0.6	36.4	25.0	8000	11000
	80	18	1.1	0.6	36.4	25.0	6400	8800
	80	18	1.1	0.6	47.2	21.5	10000	15000
	80	18	1.1	0.6	34.5	24.1	7000	9500
	80	18	1.1	0.6	34.5	24.1	7000	9500
	90	23	1.5	0.6	46.8	32.5	7600	10000
	90	23	1.5	0.6	46.8	31.0	6000	8000
	90	23	1.5	0.6	46.8	30.0	6000	8000
	90	23	1.5	0.6	46.8	30.0	6000	8000

Designations	Contact points a	Abutment and fillet dimensions			Weight kg
		d _{amax}	D _{amax}	r _{amax}	
mm					
7005AC	22.8	25	43	0	0.0758
7205C	24	30.6	46	1	0.14
7305C	14.3	32	55	1	0.224
7305BM	27.2	32	55	1	0.277
7006C	12.2	35.5	49.5	1	0.118
7206AC	27	35.6	56	1	0.215
7306C	16.3	37	65	1	0.346
7306ACM	21.6	37	65	1	0.413
7306BM	30.9	37	65	1	0.371
7207AC	31	42	65	1	0.304
7207C	15.7	42	65	1	0.304
7207BTN1	31	42	65	1	0.285
7207BM	30.9	42	65	1	0.328
7307C	18.2	44	71	1.5	0.335
7307ACM	24.1	44	71	1.5	58.5
7307BM	35	44	71	1.5	0.551
7307B	35	44	71	1.5	0.481
7407ACM	28.3	44	91	1.5	1.14
7407AC	41	46	89	1.5	0.977
7008C	14.8	45.5	62.5	1	0.188
7208C	17	47	73	1	0.364
B7208C	17	47	73	1	0.383
7208CTN1/HQ1	17	47	73	1	0.312
7208AC	34	47	73	1	0.367
7208ACM	34	47	73	1	0.429
7308C	20.2	49	81	1.5	0.624
7308ACM	26.7	49	81	1.5	0.711
7308B	38.8	49	81	1.5	0.653
7308BM	38.8	49	81	1.5	0.711

Single-row Angular Contact Ball Bearing

d 40-50 mm

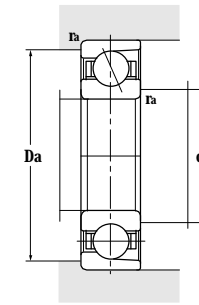
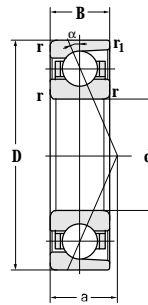

Principal dimensions					Basic load ratings		Limit speed ratings	
d	D	B	r	r ₁	C _r	Cor	Grease	Oil
mm					kN		r/min	
40	110	27	2	1	90.5	39.0	5600	7500
45	75	16	1	0.3	24.5	19	9500	13000
	75	16	1	1	24.7	19.3	14000	18000
	85	19	1.1	0.6	40.3	29.0	9600	13600
	85	19	1.1	0.6	40.3	29.0	6900	9200
	85	19	1.1	0.6	39.0	27.5	6700	9000
	85	19	1.1	0.6	39.0	27.5	6700	9000
	100	25	1.5	0.6	63.7	42.5	7000	9500
	100	25	1.5	0.6	64.1	42.5	7000	9500
	100	25	1.5	0.6	65.0	45.0	6000	8000
	100	25	1.5	0.6	68.3	39.5	5600	7500
	100	25	1.5	0.6	58	39.5	5600	7500
	100	25	1.5	0.6	55	45.0	6000	8000
	120	29	2	1	79.5	52.0	4800	6300
	120	29	2	1	79.5	52.0	4800	6300
50	80	16	1	0.3	26.5	17.3	8000	10000
	80	16	1	0.3	26	22.0	8000	17000
	80	16	1	0.3	25	20.5	8500	10000
	80	16	1	0.3	25.0	20.5	7000	9000
	90	20	1.1	0.6	42.9	32.0	6400	8500
	90	20	1.1	0.6	42.9	32.0	6080	8000
	90	20	1.1	0.6	40.3	30.0	5800	7800
	90	20	1.1	0.6	41	30.0	5800	7800
	90	20	1.1	0.6	37.7	29.0	4480	6400
	110	27	2	1	71.5	49.0	5600	7500
	110	27	2	1	70.0	44.0	5000	6700
	110	27	2	1	75.4	51.0	7000	8700
	110	27	2	1	75.4	51.0	7000	8700
	110	27	2	1	70.0	44.0	4000	5400
	110	27	2	1	70.0	44.0	5300	7000
	130	31	2.1	1.1	105	70.0	5000	7000
	130	31	2.1	1.1	96.4	64.0	4000	6000
	130	31	2.1	1.1	105	70.0	4500	6000

Designations	Contact points a	Abutment and fillet dimensions			Weight kg
		damax	Damax	ramax	
mm					
7408BM	45	60	100	2	1.47
7009AC	25.3	51	69	1	0.239
7009C	16	50.5	69.5	1	0.24
B7209C	18.2	52	78	1	0.418
7209C	18.2	52	78	1	0.403
7209AC	37	52	78	1	0.404
7209ACM	37	52	78	1	0.49
7309C	22.2	64	91	1.5	0.834
7309C/P4	22.2	64	91	1.5	0.834
7309ACM	29.4	64	91	1.5	1.02
7309BM	42.9	64	91	1.5	1.02
7309BM	42.9	64	91	1.5	1.01
7309ACM	43	54	91	1.5	1.01
7409BM	48	55	110	2	1.82
7409BT	48	55	110	2	1.65
7010CM	16.7	57	73	1	0.309
7010C	16.8	55.5	74.5	1	0.249
7010AC	26.8	56	74	1	0.254
7010ACM	23.2	57	73	1	0.314
7210C	19.4	57	83	1	0.458
B7210C	19.4	57	83	1	0.506
7210AC	26.3	57	83	1	0.460
7210ACM	26.3	57	83	1	0.561
7210B	39.4	57	83	1	0.487
7310ACM	32.2	60	100	2	1.21
7310BM	47.1	60	100	2	1.17
7310C	24.2	60	100	2	1.04
7310CM	24.2	60	100	2	1.21
7310B	47.1	60	100	2	1.05
7310BM	47	61	99	2	1.19
7410ACM	36.5	62	118	2.1	2.30
7410BM	53.3	62	118	2.1	2.36
7410AC	53	64	116	2	1.95

Single-row Angular Contact Ball Bearing

d 55-65 mm

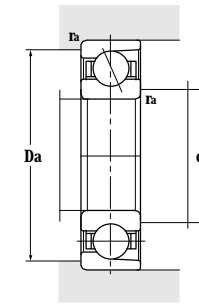
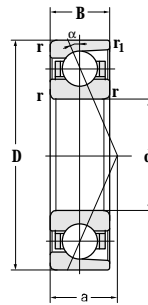

Principal dimensions					Basic load ratings		Limit speed ratings	
d	D	B	r	r ₁	C _r	C _{or}	Grease	Oil
mm					kN		r/min	
55	90	18	1.1	0.6	31.2	26.0	10000	12000
	90	18	1.1	1.1	32.5	27.0	11000	15000
	100	21	1.5	0.6	53.3	40.0	8000	10000
	100	21	1.5	0.6	53.3	40.0	8000	10000
	100	21	1.5	0.6	50.7	38.0	7100	10000
	100	21	1.5	0.6	53.3	40.0	8000	10000
	100	21	1.5	0.6	50.7	32.0	8000	10000
	100	21	1.5	0.6	34.0	34.0	5600	8000
	120	29	2	1	92.3	65.0	7000	8700
	120	29	2	1	92.3	65.0	7000	8700
	120	29	2	1	91.0	65.0	5000	6700
	120	29	2	1	88.4	63.0	5000	6700
	120	29	2	1	88.4	63.0	5000	6700
	120	29	2	1	81.0	56.0	4500	6300
	140	33	2.1	1.1	121	84.0	4500	6300
	140	33	2.1	1.1	120	90.0	4300	5600
60	95	18	1.1	0.6	35.1	30.0	7100	10000
	110	22	1.5	0.6	55.9	43.0	6700	9000
	110	22	1.5	0.6	55.9	43.0	6700	9000
	110	22	1.5	0.6	58.5	45.0	9500	13000
	110	22	1.5	0.6	49.4	36.0	5600	7800
	110	22	1.5	1.5	55.5	43.0	5000	6700
	130	31	2.1	1.1	94.9	67.0	4800	6300
	130	31	2.1	1.1	95	67.0	4800	6300
	130	31	2.1	1.1	94.9	67.0	4800	6300
	130	31	2.1	1.1	91.0	60.0	4300	5600
	130	31	2.1	1.1	91.0	60.0	3500	4500
	130	31	2.1	1.1	83.6	70.0	4500	6000
	150	35	2.1	1.1	131	95.0	3800	5000
	150	35	2.1	1.1	120	86.0	3000	4000
	150	35	2.1	1.1	92.0	86.0	3800	5000
	150	35	2.1	1.1	130	96.0	3800	5000
65	100	18	1.1	0.6	33.8	31.0	6700	9500
	100	18	1.1	0.6	37.7	34.0	5400	7600

Designations	Contact points a	Abutment and fillet dimensions			Weight kg
		damax	Damax	ramax	
mm					
7011AC	25.9	62	83	1	0.385
7011C	18.7	62	83	1	0.386
7211C	20.9	64	91	1.5	0.599
B7211C	20.9	64	91	1.5	0.600
7211AC	28.6	64	91	1.5	0.599
7211CM	20.9	65	91	1.5	0.698
7211C/HQ1	20.9	65	91	1.5	0.578
7211BM	43	65	91	1.5	1.698
7311CM	26.2	65	110	2	1.65
7311C	26.2	65	110	2	1.44
7311AC	34.9	65	110	2	1.44
7311ACM	34.9	65	110	2	1.65
7311ACQ1	34.9	65	110	2	1.64
7311BM	51.2	65	110	2	1.61
7411ACM	39.3	67	128	2.1	2.79
7411AC	58	69	126	2	2.38
7012AC	27.1	67	88	1	0.392
7212AC	30.8	69	101	1.5	0.786
7212ACM	30.8	69	101	1.5	0.951
7212C	22.4	69	101	1.5	0.786
7212BM	46.7	69	101	1.5	0.947
7212ACM	47	69	101	1.5	0.945
7312AC	37.7	72	118	2	1.80
7312AC/P4	37.7	72	118	2	1.82
7312ACM	37.7	72	118	2	2.12
7312BM	55.4	72	118	2	2.14
7312B	55.4	72	118	2	1.86
7312CM	55	72	118	2	2.03
7412ACM	42	72	138	2	3.65
7412BM	61.6	72	138	2	3.42
7412BT	62	74	136	2	3.15
7412AC	62	74	136	2	3.11
7013AC	28.2	72	93	1	0.414
7013ACJ	28.2	72	93	1	0.410

Single-row Angular Contact Ball Bearing

d 65-70 mm

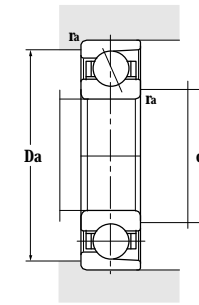
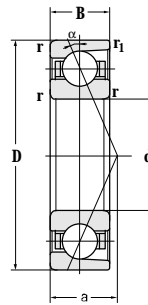

Principal dimensions					Basic load ratings		Limit speed ratings	
d	D	B	r	r ₁	C _r	C _{or}	Grease	Oil
mm					kN		r/min	
65	100	18	1.1	0.6	33.8	31.0	6700	9500
	100	18	1.1	0.6	33	30.5	6700	9500
	120	23	1.5	0.6	72.8	59.0	9000	12000
	120	23	1.5	0.6	72.8	56.0	6000	8500
	120	23	1.5	0.6	70.2	56.0	6000	8500
	120	23	1.5	0.6	70.2	56.0	6000	8500
	120	23	1.5	0.6	74	59.0	9000	12000
	140	33	2.1	1.1	120	88.0	8000	10000
	140	33	2.1	1.1	120	88.0	6400	8000
	140	33	2.1	1.1	120	88.0	6300	8000
	140	33	2.1	1.1	114	84.0	4300	6000
	140	33	2.1	1.1	114	84.0	3400	4800
	140	33	2.1	1.1	114	84.0	4300	6000
	140	33	2.1	1.1	101	75.0	3800	5300
	140	33	2.1	1.1	114	84.0	3500	4800
	140	33	2.1	1.1	101	75.0	3000	4200
	160	37	2.1	1.1	129	97.0	2800	4300
70	110	20	1.1	0.6	44.2	41.0	6300	8500
	110	20	1.1	0.6	44.2	41.0	6300	8500
	125	24	1.5	0.6	79.3	65.0	8500	11000
	125	24	1.5	0.6	79.3	65.0	8500	11000
	125	24	1.5	0.6	75.4	62.0	5600	8000
	125	24	1.5	0.6	75.4	62.0	5600	8000
	125	24	1.5	0.6	79.3	65.0	6800	8800
	125	24	1.5	0.6	79.3	65.0	8500	11000
	125	24	1.5	0.6	68.0	54.0	4000	5600
	150	35	2.1	1.1	134	100	6500	8000

Designations	Contact points a	Abutment and fillet dimensions			Weight kg
		d _{amax}	D _{amax}	r _{amax}	
mm					
7013ACM	28.2	72	93	1	0.504
7013ACM	32.8	72	93	1	0.504
7213C	23.9	74	111	1.5	1.02
7213AC/P5	33.1	74	111	1.5	1.02
7213ACM	33.1	74	111	1.5	1.16
7213AC/YB5	33.1	74	111	1.5	1.02
7213CM	50	74	111	1.5	1.16
7313CM	30.2	77	128	2	2.50
7313CJ	30.2	77	128	2	2.23
7313C	30.2	77	128	2	2.23
7313ACM	40.4	77	128	2	2.61
7313ACJ	40.4	77	128	2	2.24
7313AC	40.4	77	128	2	2.24
7313BM	59.5	77	128	2	2.48
B7313ACM	40.4	77	128	2	2.61
7313B	59.5	77	128	2	1.95
7413BM	65.7	77	148	2	3.82
7014AC	31	77	103	1	0.626
7014ACM	31	77	103	1	0.725
7214CM	25.1	79	116	1.5	1.24
7214C	25.1	79	116	1.5	1.10
7214ACM	34.7	79	116	1.5	1.24
7214AC	34.7	79	116	1.5	1.10
B7214C	25.1	79	116	1.5	1.16
7214CTN1	25.1	79	116	1.5	1.09
7214BM	52.9	79	116	1.5	1.27
7314C	32.2	82	138	2	2.69

Single-row Angular Contact Ball Bearing

d 70-75 mm

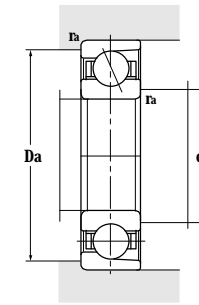
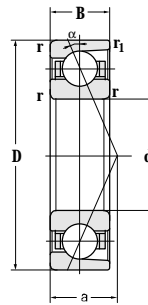

Principal dimensions					Basic load ratings		Limit speed ratings	
d	D	B	r	r ₁	C _r	C _{or}	Grease	Oil
mm					kN		r/min	
70	150	35	2.1	1.1	134	100	6500	8000
	150	35	2.1	1.1	129	96.0	4000	5300
	150	35	2.1	1.1	129	96.0	4000	5300
	150	35	2.1	1.1	114	86.0	3200	4200
	150	35	2.1	1.1	114	86.0	3600	5000
	180	42	3	1.1	164	131	3600	5000
	180	42	3	1.1	164	131	2900	4000
	180	42	3	1.1	148	118	2500	3500
	180	42	3	1.1	114	118	3200	4300
	180	42	3	1.1	163	131	3200	4300
75	115	20	1.1	1.1	46.5	43.5	6800	8500
	130	25	1.5	0.6	78.7	66.5	6800	8500
	130	25	1.5	0.6	79.3	67.0	5600	7500
	130	25	1.5	0.6	79.3	67.0	5600	7500
	130	25	1.5	0.6	79.3	67.0	4480	6000
	130	25	1.5	0.6	79.3	67.0	4480	6000
	160	37	2.1	1.1	146	113	5800	7000
	160	37	2.1	1.1	146	113	4800	5600
	160	37	2.1	1.1	140	109	3800	5000
	160	37	2.1	1.1	140	109	3800	5000
	160	37	2.1	1.1	140	109	3800	5000
	160	37	2.1	1.1	125	97.0	3400	4800
	160	37	2.1	1.1	125	97.0	2700	3800
	160	37	2.1	1.1	140	109	3400	4800
	160	37	2.1	1.1	140	109	3800	5000
	190	45	3	1.1	159	130	2400	3800
	190	45	3	1.1	122	130	2400	3800

Designations	Contact points a	Abutment and fillet dimensions			Weight kg
		d _{amax}	D _{amax}	r _{amax}	
mm					
7314CM	32.2	82	138	2	3.04
7314AC	43.2	82	138	2	2.69
7314ACM	43.2	82	138	2	3.04
7314B	63.7	82	138	2	2.85
7314BM	63.7	82	138	2	3.16
7414ACM	50.1	84	166	2.5	5.22
7414ACJ	50.1	84	166	2.5	4.86
7414BM	73.4	84	166	2.5	5.64
7414BT	74	84	166	2.5	5.23
7414AC	74	84	166	2.5	4.76
7015C	22.7	82	108	1	0.641
7215C/P5	26.2	84	121	1.5	1.24
7215ACM	36.4	84	121	1.5	1.34
7215AC	36.4	84	121	1.5	1.18
7215ACJ	36.4	84	121	1.5	1.18
7215ACTN1	36.4	84	121	1.5	1.21
7315CM	34.2	87	148	2	3.57
7315CJ	34.2	87	148	2	3.11
7315AC	45.9	87	148	2	3.11
7315ACM	45.9	87	148	2	3.54
7315ACQ1	45.9	87	148	2	3.52
7315BM	67.8	87	148	2	3.4
7315B	67.8	87	148	2	3.26
7315ACJ	45.9	87	148	2	3.10
7315ACTN1	45.9	87	148	2	3.08
7415BM	78.2	89	176	2.5	6.80
7415BT	78.2	89	176	2.5	6.30

Single-row Angular Contact Ball Bearing

d 80-85 mm

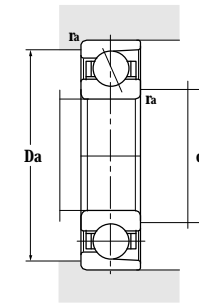
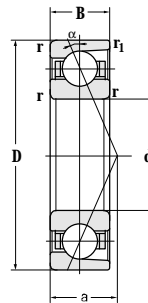

Principal dimensions					Basic load ratings		Limit speed ratings	
d	D	B	r	r ₁	C _r	C _{or}	Grease	Oil
mm					kN		r/min	
80	125	22	1.1	0.6	55.9	53.0	6500	8000
	125	22	1.1	0.6	56.5	52.5	5600	7500
	125	22	1.1	0.6	55.9	53.0	6500	8000
	125	22	1.1	0.6	55.9	53.0	4500	6000
	125	22	1.1	0.6	55.9	53.0	5600	7500
	140	26	2	1.1	126	82.5	3800	5000
	140	26	2	1	97.5	83.0	7500	10000
	140	26	2	1	92.3	79.0	5000	7100
	140	26	2	1	97.5	83.0	6000	8000
	140	26	2	1	92.3	79.0	5000	7100
	140	26	2	1	92.3	79.0	5000	7100
	170	39	2.1	1.1	152	122	3600	4800
	170	39	2.1	1.1	152	122	2800	3800
	170	39	2.1	1.1	152	122	3600	4800
	170	39	2.1	1.1	152	122	3600	4800
	170	39	2.1	1.1	135	109	3400	4500
	200	48	3	1.1	195	168	2600	3800
	200	48	3	1.1	195	168	2600	3800
200	48	3	1.1	195	168	2100	3000	
200	48	3	1.1	178	153	2200	3200	
200	48	3	1.1	178	153	2200	3200	
85	130	22	1.1	0.6	57.2	56.0	5300	7100
	130	22	1.1	0.6	57.2	56.0	5300	7100
	130	22	1.1	1.1	59.5	58.5	7600	10000
	150	28	2	1	104	90.0	6700	9500
	150	28	2	1	104	90.0	5400	7600
	150	28	2	1	98.8	86.0	4800	6700
	150	28	2	1	98.8	86.0	4800	6700
	150	28	2	1	98.8	86.0	4800	6700
	150	28	2	1	98.8	86.0	3800	5400
	150	28	2	1	98.8	86.0	3800	5400
	150	28	2	1	97	72.0	3600	4800

Designations	Contact points a	Abutment and fillet dimensions			Weight kg
		damax	Damax	ramax	
mm					
7016AC/P4	24.7	87	118	1	0.845
7016AC	40.6	87	118	1	0.849
7016CA/HQ1P4	24.7	87	118	1	0.845
7016ACJ	34.9	87	118	1	0.849
7016ACM	34.9	87	118	1	0.983
7216C	59	91	129	2	1.52
7216CM	27.7	90	130	2	1.74
7216ACM	38.7	90	130	2	1.73
B7216C	27.7	90	130	2	1.47
7216AC	38.7	90	130	2	1.48
7216AC/P4	38.7	90	130	2	1.48
7316ACM	48.7	92	158	2	4.1
7316ACJ	48.7	92	158	2	3.88
7316AC	48.7	92	158	2	3.59
7316ACF3	48.7	92	158	2	4.15
7316BM	71.9	92	158	2	4.15
7416ACM	56.7	94	186	2.5	8.60
7416AC	56.7	94	186	2.5	7.18
7416ACJ	56.7	94	186	2.5	7.22
7416BM	82.7	96	184	2.5	8.05
7416BT	77	96	184	2.5	7.3
7017ACM	36.1	92	123	1	1.11
7017AC	36.1	92	123	1	0.95
7017C	25.5	92	123	1	0.901
7217CM	29.7	95	140	2	2.11
7217CJ	29.7	95	140	2	1.96
7217AC	41.4	95	140	2	1.91
7217ACTN1	41.4	95	140	2	1.96
7217ACM	41.4	95	140	2	1.72
7217ACJ	41.4	95	140	2	1.97
7217BM	63	96	139	2	2.26

Single-row Angular Contact Ball Bearing

d 85-95 mm

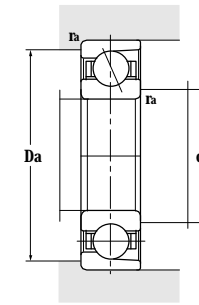
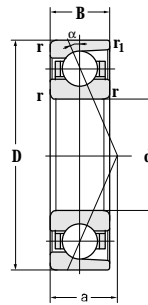

Principal dimensions					Basic load ratings		Limit speed ratings	
d	D	B	r	r ₁	C _r	C _{or}	Grease	Oil
mm					kN		r/min	
85	180	41	3	1.1	146	122	3000	4000
	180	41	3	1.1	146	122	3000	4000
	180	41	3	1.1	146	122	3000	4000
	180	41	3	1.1	125	137	3200	4300
	180	41	3	1.1	165	137	3200	4300
	180	41	3	1.1	123	122	3200	4300
	180	41	3	1.1	165	137	3200	4300
	90	140	24	1.5	0.6	67.6	66.0	4800
140		24	1.5	0.6	45.0	57.0	4300	6200
140		24	1.5	0.6	69.0	66.0	4800	6700
140		24	1.5	0.6	58.5	57.0	4300	6200
160		30	2	1	122	105	6300	9000
160		30	2	1	122	105	6300	9000
160		30	2	1	117	100	4500	6000
160		30	2	1	117	100	3600	4800
160		30	2	1	117	100	4500	6000
160		30	2	1	103	88.0	3200	4300
160		30	2	1	117	100.0	3400	4500
190		43	3	1.1	120	135.0	3000	4000
190		43	3	1.1	135	152.0	3000	4000
190		43	3	1.1	141	158.0	3000	4000
190		43	3	1.1	183	158	5200	6300
190		43	3	1.1	176	152	3200	4300
190		43	3	1.1	156	135	2800	3800
190		43	3	1.1	172	145	4200	8800
190		43	3	1.1	156	135	2200	3000
225		54	4	1.5	233	214	2900	4000
225		54	4	1.5	210	193	1900	2900
225		54	4	1.5	230	213	1900	2800
225	54	4	1.5	210	193	1900	2800	
95	145	24	1.5	0.6	53.5	69.0	5200	6300

Designations	Contact points a	Abutment and fillet dimensions			Weight kg
		damax	Damax	ramax	
mm					
7317BM	76.1	99	166	2.5	4.89
7317BT	76.1	99	166	2.5	4.34
7317BTN1	76.2	99	166	2.5	4.26
7317AC	76	99	166	2.5	4.35
7317ACM	76	99	166	2.5	5.02
7317BM	76	99	166	2.5	5.02
IS-7317ACM	76	99	166	2.5	5.02
7018ACM	38.8	99	131	1.5	1.39
7018BT	60.2	99	131	1.5	1.2
7018ACMA/P5	38.8	99	131	1.5	1.37
7018BM	60.2	99	131	1.5	1.43
7218CM	31.7	100	150	2	2.37
7218C	31.7	100	150	2	2.09
7218ACM	44.1	100	150	2	2.39
7218ACJ	44.1	100	150	2	2.16
7218AC	44.1	100	150	2	2.11
7218BM	67.4	100	150	2	3.38
7218ACM-NTW	67	101	149	2	2.39
7318BT	80	104	176	2.5	4.75
7318AC	80	104	176	2.5	5.35
7318C	80	104	176	2.5	4.96
7318CM	40.3	104	176	2.5	5.7
7318ACM	54.1	104	176	2.5	6.17
7318BM	80.2	104	176	2.5	5.13
B7318C	40.3	104	176	2.5	4.90
7318B	80.2	104	176	2.5	4.94
7418ACM	63.8	108	207	3	11.5
7418BM	93.1	110	205	3	11.4
7418AC	86	110	205	3	10
7418BT	86	110	205	3	10.3
7019ACM	40	93	135	1.5	1.44

Single-row Angular Contact Ball Bearing

d 95-110 mm

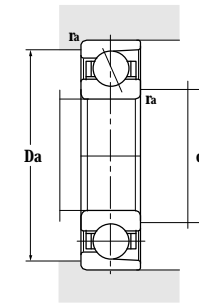
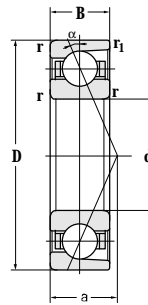

Principal dimensions					Basic load ratings		Limit speed ratings	
d	D	B	r	r ₁	C _r	C _{or}	Grease	Oil
mm					kN		r/min	
95	145	24	1.5	0.6	53.5	69	5200	6300
	145	24	1.5	1.5	74	73	6700	8900
	170	32	2.1	1.1	139	120	6000	8500
	170	32	2.1	1.1	139	120	4800	6800
	170	32	2.1	1.1	133	114	4300	5600
	170	32	2.1	1.1	133	114	3400	4500
	170	32	2.1	1.1	116	101	3000	4000
	200	45	3	1.1	168	150	2900	3900
	200	45	3	1.5	196	174	2800	3800
	200	45	3	1.1	188	167	2800	3800
100	150	24	1.5	0.6	76.7	77.0	4500	6000
	180	34	2.1	1.1	156	136	5600	8000
	180	34	2.1	1.1	130	114	2800	3800
	180	34	2.1	1.1	148	130	4000	5300
	180	34	2.1	1.1	148	130	4000	5300
	215	47	3	1.1	210	198	2600	3600
	215	47	3	1.1	213	199	2800	3800
	215	47	3	1.1	190	177	2400	3400
	215	47	3	1.1	190	177	1900	2700
	215	47	3	1.1	190	177	1900	2700
	215	47	3	1.1	210	198	2600	3600
	105	190	36	2.1	1.1	131	114	2800
225		49	3	1.1	202	193	2400	3200
110	170	21	1.5	1.5	76.7	82.0	4800	6800
	170	28	2	1	98.8	101	3200	4200
	170	28	2	1	98.8	101	3200	4200
	170	28	2	1	98.8	101	4000	5300
	170	28	2	1	98.8	101	4000	5300
	175	30	1.1	0.7	103	104	3200	4200

Designations	Contact points a	Abutment and fillet dimensions			Weight kg	
		damax	Damax	ramax		
mm						
7019AC	40	93	135	1.5	1.21	
7019C	28.3	103.5	136.5	1.5	1.21	
7219CM	33.8	107	158	2	2.95	
7219CJ	33.8	107	158	2	2.76	
7219ACM	46.9	107	158	2	2.95	
7219ACJ	46.9	107	158	2	2.76	
7219B	71.7	107	158	2	3.00	
7319BM	84.4	109	186	2.5	6.67	
7319CM	84	109	186	2.5	6.32	
7319ACM	84	109	186	2.5	6.32	
7020AC	41.2	109	141	1.5	1.25	
	35.8	112	168	2	3.57	
	75.7	112	168	2	4.00	
	49.6	112	168	2	3.25	
	49.6	112	168	2	3.25	
	7320AC	90	114	201	2.5	8.33
	7320ACM	60.2	114	201	2.5	9.61
	7320BM	89.6	114	201	2.5	8.41
	7320B	89.6	114	201	2.5	7.29
	7320BT	89.6	114	201	2.5	7.58
	7320ACM	90	114	201	2.5	9.68
	7221ACM	80	117	178	2	4.36
7321BM	93.7	119	211	2.5	9.51	
7022AX2M	50.9	115	165	1.5	1.86	
	46.6	120	160	2	1.90	
	47	120	160	2	2.03	
	7022ACM	46.7	120	160	2	2.41
	7022AC	46.7	120	160	2	2.16
	46722K	49.7	117	168	1	2.38

Single-row Angular Contact Ball Bearing

d 110~130 mm

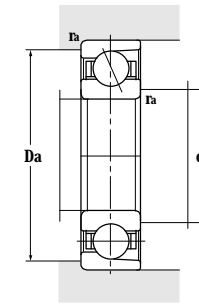
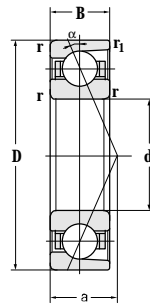

Principal dimensions					Basic load ratings		Limit speed ratings		
d	D	B	r	r ₁	C _r	C _{or}	Grease	Oil	
mm					kN		r/min		
110	200	38	2.1	1.1	185	171	5000	7100	
	200	38	2.1	1.1	185	171	4000	5700	
	200	38	2.1	1.1	185	171	5000	7100	
	200	38	2.1	1.1	176	164	3600	4800	
	200	38	2.1	1.1	176	164	3600	4800	
	200	38	2.1	1.1	176	164	2900	3800	
	200	38	2.1	1.1	153	144	2600	3400	
	240	50	3	1.1	191	240	3600	4800	
	240	50	3	1.1	239	231	2600	3400	
	240	50	3	1.1	213	212	2200	3000	
	240	50	3	1.1	213	212	2200	3000	
	240	50	3	1.1	213	212	1800	2400	
	240	50	3	1.1	213	212	1800	2400	
	120	180	28	2	1	100	107	3600	5000
180		28	2	1	100	107	3600	5000	
215		40	2.1	1.1	190	184	3200	4500	
215		40	2.1	1.3	247	184	2600	3600	
215		40	2.1	1.1	198	192	2200	3200	
215		40	1.3	2.1	204	239	2200	3200	
215		40	2.1	1.1	190	184	2200	3200	
260		55	3	1.1	251	262	1600	2200	
260		55	3	1.1	278	288	3400	4000	
260		55	3	1.1	268	277	1800	2400	
260		55	3	1.1	268	277	1800	2400	
260		55	3	1.1	265	269	2200	3000	
130		200	33	2	1	129	137	5400	6500
		200	33	2	1.1	108	118	4500	5000
	230	40	3	1.1	207	209	2400	3200	

Designations	Contact points a	Abutment and fillet dimensions			Weight kg
		d _{amax}	D _{amax}	r _{amax}	
mm					
7222CM	39.8	122	188	2	5.03
7222CJ	39.8	122	188	2	4.14
7222C	39.8	122	188	2	4.07
7222ACM	55.1	122	188	2	4.65
7222AC	55.1	122	188	2	4.07
7222ACJ	55.1	122	188	2	4.14
7222BM	84	122	188	2	3.95
7322CM	48.4	124	210	2.5	9.67
7322ACM	65.8	124	226	2.5	9.97
7322BM	99.3	124	226	2.5	11.5
7322BM/YA8	98.4	124	226	2.5	11.7
7322B	99.3	124	226	2.5	9.84
B7322BQ1	99.2	124	226	2.5	11.4
7024ACM	49	130	170	2	2.62
7024AC	49	130	170	2	2.31
7224ACM	59.1	132	203	2	6.17
B7224ACQ1/HASO	59	132	203	2	6.45
7224CM	90	132	203	2	6.07
B7224ACQ1/HASO	90	132	203	2	6.45
7224AC/P4	98.1	137	199	2	5.56
7324B	107.2	134	246	2.5	14.6
B7324CM	52.9	134	246	2.5	14.2
B7324ACM	71.8	134	246	2.5	14.2
B7324ACQ1	71.8	134	246	2.5	14.0
7324AC	71.8	134	246	2.5	13.7
7026C	38.6	140	190	2	3.33
7026BM	155	144	186	2	3.85
7226CM	44.1	144	216	2.5	7

Single-row Angular Contact Ball Bearing

d 130~160 mm

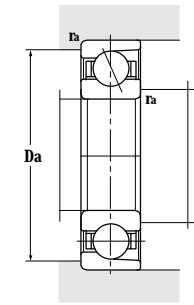
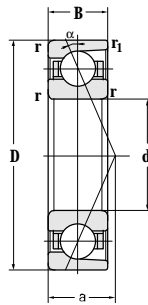

Principal dimensions					Basic load ratings		Limit speed ratings		
d	D	B	r	r ₁	C _r	C _{or}	Grease	Oil	
mm					kN		r/min		
130	230	40	3	1.1	196	200	2400	3200	
	230	40	3	1.1	196	200	1900	2600	
	230	40	3	1	170	175	2200	3000	
	280	58	4	1.5	250	268	1800	2400	
140	210	33	2	1	125	137	3200	4300	
	210	33	2	1	125	137	3200	4300	
	250	42	3	1.1	231	243	4200	5000	
	250	42	3	1.1	220	237	2200	3000	
	250	42	3	1.1	217	235	2200	3000	
	250	42	3	1.1	191	207	2000	2800	
	300	62	4	1.5	275	300	1600	2200	
	300	62	4	1.5	275	300	1600	2200	
	300	62	4	1.5	276	301	2100	2800	
	150	225	35	2.1	1.1	153	170	2400	3000
225		35	2.1	2.1	155	170	1900	2800	
225		35	2.1	2.1	155	170	5400	7300	
270		45	3	1.1	195	222	1700	2400	
270		45	3	1.1	242	268	2000	2800	
270		45	3	1.1	226	254	1600	2200	
320		65	4	1.5	359	429	1800	2400	
320		65	4	1.5	317	380	2300	2000	
160		229.5	33	2	2	93.5	128	2000	2400
		240	38	2.1	1.1	161	183	1800	2200
	240	38	2.1	1.1	161	183	1800	2200	
	240	38	2.1	1.1	161	183	1800	2200	
	240	38	2.1	1.1	161	183	1800	2200	
	240	38	1.1	2.1	160	237	4800	2600	
	290	48	3	1.1	263	304	2900	3600	
	290	48	3	1.1	250	289	1900	2600	
	340	68	4	1.5	337	409	1200	1600	
	340	68	4	4	355	420	1600	2200	

Designations	Contact points a	Abutment and fillet dimensions			Weight kg
		damax	Damax	ramax	
mm					
7226ACM	62	144	216	2.5	6.98
7226ACJ	62	144	216	2.5	6.23
7226BM	95.5	144	216	2.5	7.56
7326B	115.1	148	262	3	17.9
7028AC	57.3	150	200	2	3.46
7028ACM	57.3	150	200	2	4.14
7228CM	47.1	154	236	2.5	8.31
7228ACM	66.5	154	236	2.5	8.43
B7228ACYQ1	68.5	154	236	2.5	8.70
7228BM	102.9	154	236	2.5	8.59
7328B	123.3	158	282	3	21.2
7328B/YA8	123.3	158	282	3	23.1
7328BA	123.3	158	282	3	21.6
7030ACM	61.2	162	213	2	4.80
7030AC	96	160	219	2	4.23
7030AC/P4	96	160	219	2	4.23
7230BM	111	164	256	2.5	11.7
7230AC	71.5	164	256	2.5	12.1
B7230AC	71.4	164	256	2.5	10.6
7330AC	87.6	168	302	3	25.8
7330B	131	168	302	3	26.2
72932X3BM	65.6	172	228	2	4.53
B7032ACQ1	65.6	172	228	2	5.74
B7032ACM	65.6	172	228	2	5.81
7032ACM	65.6	172	228	2	5.95
146132QT	103	171	229	2	5.74
7232C	54.1	174	276	2.5	14.5
7232AC	76.5	174	276	2.5	14.5
7332B	138.9	178	322	3	30.8
7332AC	106.2	178	322	3	37.7

Single-row Angular Contact Ball Bearing

d 160~200 mm

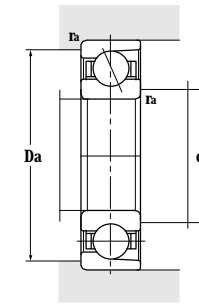
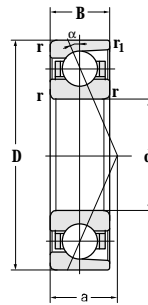

Principal dimensions					Basic load ratings		Limit speed ratings	
d	D	B	r	r ₁	C _r	C _{or}	Grease	Oil
mm					kN		r/min	
160	400	88	5	2	449	580	1100	1600
170	260	42	2.1	1.1	199	227	2000	2600
	260	42	2.1	1.1	199	227	2000	2600
	260	42	2.1	1.1	200	232	2000	2600
	260	42	2.1	1.1	209	181	1700	2400
	310	52	4	1.5	321	389	2800	3400
	310	52	4	1.5	306	371	1800	2400
	310	52	4	1.5	266	325	1600	2200
	310	52	4	1.5	282	343	1500	1900
	360	72	4	1.5	380	495	1350	1800
	360	72	4	1.5	430	491	1400	1900
180	250	33	2	1	160	196	3200	4300
	280	46	2.1	1.1	190	235	1650	2200
	320	52	4	1.5	333	418	2700	3200
	320	52	4	1.5	317	399	1700	2200
	380	75	4	1.5	404	536	1300	1800
	380	75	4	1.5	455	605	1300	1800
190	290	46	2.1	1.1	215	263	1800	2400
	340	55	4	1.5	257	430	1500	2000
	340	55	4	1.5	330	430	1700	2300
	400	78	5	2	430	600	1150	1600
200	310	51	2.1	1.1	264	331	1700	2200
	310	51	2.1	1.1	264	331	1700	2200
	360	58	4	1.5	363	487	2500	3000
	360	58	4	1.5	345	462	1500	2000
	360	58	4	1.5	345	462	1500	2000
	360	58	4	1.5	309	417	1300	1800
	420	80	5	2	450	660	1000	1500
	420	80	5	2	475	670	1100	1600

Designations	Contact points a	Abutment and fillet dimensions			Weight kg
		damax	Damax	ramax	
		mm			
7432BM	161	180	382	4	61.4
7034ACQ1	71.1	182	248	2	8.27
7034AC	71.1	182	248	2	7.98
7034AC/P4	71.1	182	248	2	7.02
46134QT	111	181	249	2	8.27
7234C	58.2	188	292	3	17.1
7234AC	82	188	292	3	17.1
7234B	126.7	187	293	3	17.8
B7234AC	82	188	292	3	17.4
7334B	147	188	342	3	34.5
7334AC	147	187	343	3	36.6
71936CM	45.3	192	235	2	4.88
7036B	119	192	268	2	10
7236C	59.5	198	302	3	17.9
7236AC	84.3	198	302	3	17.9
7336B	155	198	362	3	37.0
7336AC	156	197	363	3	42.5
7038AC	79	202	278	2	10.6
7238AC	89.3	222	324	3	22.4
7238AC/P4	89.3	222	324	3	22.4
7338B	164	212	380	4	48
7040AC	85	212	298	2	14.9
7040ACN1	85	212	298	2	14.8
7240C	66.5	218	342	3	25.2
7240AC	94.3	218	342	3	25.2
7240ACL3	94.3	218	342	3	24
7240B	146.5	218	342	3	25.8
7340B	170	222	400	4	53
7340AC	170	220	400	4	56.3

Single-row Angular Contact Ball Bearing

d 220~340 mm

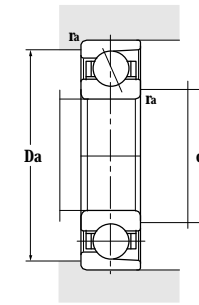
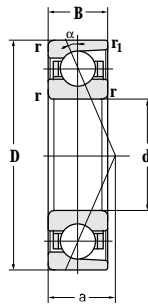

Principal dimensions					Basic load ratings		Limit speed ratings	
d	D	B	r	r ₁	C _r	C _{or}	Grease	Oil
mm					kN		r/min	
220	300	38	2.1	1.1	170	238	1500	2000
	300	38	2.1	1.1	171	238	1500	2000
	400	65	4	1.5	423	605	1100	1600
	460	88	5	2	480	730	1000	1400
240	320	48	2.1	1.1	185	250	1000	1500
	320	38	2.1	1.1	188	258	1100	1600
	360	56	3	1.1	250	380	1150	1600
	440	72	4	1.5	419	626	1000	1500
	440	72	4	1.5	435	650	1000	1500
	500	95	5	2	540	850	850	1200
260	360	46	2.1	1.1	260	380	900	1400
	360	46	2.1	1.1	275	405	1300	1800
	480	80	5	2	495	790	850	1200
280	380	46	2.1	1.1	268	405	800	1300
	420	65	4	1.5	310	500	900	1300
	420	65	4	1.5	315	500	900	1300
	500	80	5	2	500	840	800	1200
285	380	46	2.1	1.1	244	366	800	1200
300	460	74	4	1.5	410	690	950	1300
	460	74	4	1.5	360	620	900	1200
	460	74	4	1.5	400	665	950	1400
320	440	56	3	1.1	340	580	940	1400
	480	74	4	1.5	416	700	800	1100
340	420	38	2.1	1.1	196	325	950	1400
	460	56	3	1.1	330	575	900	1350
	520	82	5	2	510	1050	800	1100

Designations	Contact points a	Abutment and fillet dimensions			Weight kg
		d _{amax}	D _{amax}	r _{amax}	
		mm			
71944C	129	229	291	2	8.34
71944CTA	129	229	291	2	7.02
7244AC	104.7	238	382	3	35.8
7344B	187	242	440	4	71
72948AC	89.3	252	308	2	10.0
71948AC	89.3	252	308	2	8.70
7048B	154	256	345	2.5	19.5
7248B	178.5	258	411	3	50.9
7248AC	180	257	423	3	51.1
7348B	203	262	481	4	89
71952AC	95.3	291	348	2	13.8
71952C	113	271	349	2	13.7
7252B	195	280	460	4	67
71956AC	99.9	292	368	2	15.7
7056B	179	296	406	3	31
7056BM	179	296	406	3	31
7256B	204	300	480	4	70.5
B71957Y	119	297	368	2	14.7
7060A	147	318	442	3	43
7060B	196	318	442	3	43
7060AC	147	317	443	3	46.5
71964AC	116	334	426	2.5	26.5
7064AC/P6	130	385	445	3	47.5
71868AC	129	351	409	2	11.4
71968AC	126	354	446	2.5	24.5
7068AC	141.3	360	500	4	61.0

Single-row Angular Contact Ball Bearing

d 340~460 mm

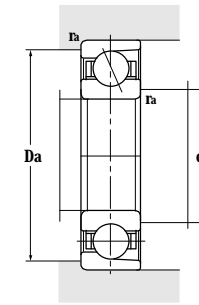
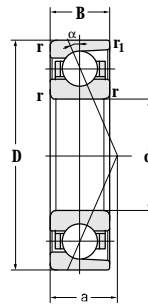

Principal dimensions					Basic load ratings		Limit speed ratings	
d	D	B	r	r ₁	C _r	C _{or}	Grease	Oil
mm					kN		r/min	
340	620	92	6	3	685	1320	700	1000
360	440	38	2.1	1.1	228	430	1800	2650
	480	56	3	1.1	340	630	900	1300
	480	56	3	1.1	330	620	850	1000
	480	56	3	3	360	630	800	1100
	480	56	3	1.1	290	540	850	1000
	540	82	5	1.3	532	965	600	1000
	650	95	6	3	635	1240	700	950
380	480	31	2	1	185	340	860	1200
	480	46	2.1	1.1	285	495	860	1200
	520	65	4	1.5	355	630	500	800
	520	65	4	4	415	760	800	1100
	560	82	5	2	495	940	810	1100
	560	82	5	2	455	880	760	1000
400	540	65	4	1.5	410	760	810	1100
	540	65	4	4	420	780	800	1100
	600	90	5	2	590	1170	740	1000
	600	90	5	2	515	1010	710	960
420	560	65	4	1.5	410	820	810	1100
	560	65	4	1.5	355	670	810	1100
	620	90	5	2	590	1160	710	960
	620	90	5	2	525	1040	680	910
440	600	74	4	1.5	495	1050	740	1000
	650	94	6	3	635	1300	710	960
	650	94	6	3	560	1170	630	840
460	580	37	2.1	1	259	550	760	1000
	580	56	3	3	362	760	760	1000
	580	56	3	1.1	335	635	750	1000
	620	74	4	1.5	495	1050	680	740
	680	100	6	3	675	1450	670	910

Designations	Contact points a	Abutment and fillet dimensions			Weight kg
		d _{amax}	D _{amax}	r _{amax}	
		mm			
7268B	248	366	593	5	128
71872AC	112	371	430	2	12.5
71972AC	126	374	468	2.5	29.5
71972A	149	374	468	2.5	29.5
71972ACM/P5	204	373	467	2.5	28.3
71972B	204	374	468	2.5	29.5
7072CF3	101.3	382	518	4	65.3
7272B	261	387	624	5	152
70876A	142	390	470	2	13.5
71876AC	123	392	470	2	18.5
71976B	221.4	398	502	3	42.1
71976AC	222	395	505	3	41.5
7076A	177	399	541	4	66
7076B	238	399	541	4	66
71980A	168	416	525	3	42.5
71980AC	168	415	525	3	44.3
7080A	189	418	580	4	91.5
7080B	255	418	580	4	91.5
71984A	174	436	545	3	46.5
71984B	238	436	545	3	46.5
7084A	195	439	601	4	97
7084B	263	440	602	4	93
71988AC	158	456	585	3	60
7088A	204	464	626	5	100
7088B	276	464	626	5	100
70892A	169	472	568	2	25.5
71892A	178	474	566	2.5	34.5
71892AC	169	471	569	2	34.8
71992AC	163	476	606	3	58.5
7092A	215	484	656	5	121

Single-row Angular Contact Ball Bearing

d 460~710 mm

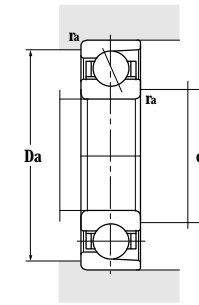
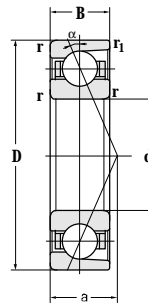

Principal dimensions					Basic load ratings		Limit speed ratings	
d	D	B	r	r ₁	C _r	C _{or}	Grease	Oil
mm					kN		r/min	
460	680	100	6	3	605	1280	610	800
480	700	100	6	3	685	1540	630	840
	700	100	6	3	610	1330	550	740
500	620	37	2.1	1.1	270	610	660	890
	620	56	3	1.1	390	810	600	850
	670	78	5	2	540	1210	620	850
	720	100	6	3	700	1610	610	810
	720	100	6	3	620	1410	550	760
530	650	56	3	1.1	380	890	620	840
	650	56	3	3	350	715	630	850
	710	82	5	2	600	1350	610	810
	780	112	6	3	815	1880	550	740
	780	112	6	3	725	1690	510	680
560	680	56	3	1.1	385	920	600	810
	750	85	5	2	580	1270	550	740
	820	115	6	3	880	2140	520	710
600	730	42	3	1.1	330	730	560	740
	730	60	3	1.1	405	880	720	760
	730	60	3	1.1	405	880	560	750
	800	90	5	2	700	1720	540	710
	870	118	6	3	865	2150	470	620
630	920	128	7.5	4	935	2460	420	550
670	820	69	4	1.5	540	1280	490	640
	980	136	7.5	4	1140	3180	470	630
710	870	74	4	1.5	530	1290	450	600
	870	74	4	1.5	530	1290	450	600
	870	74	4	4	555	1350	450	600

Designations	Contact points a	Abutment and fillet dimensions			Weight
		d _{amax}	D _{amax}	r _{amax}	
		mm			kg
7092B	289	484	656	5	121
7096A	220	503	677	5	126
7096B	298	503	677	5	126
708/500A	180	512	610	2	27.5
718/500AMB	189.7	513	607	2.5	37.4
719/500A	208	520	651	4	77.5
70/500A	226	526	696	5	132
70/500B	306	526	696	5	132
718/530A	198	544	637	2.5	38.5
718/530AC	198	543	637	2.5	40.1
719/530AC	186	559	691	4	93
70/530A	245	554	756	5	178
70/530B	332	554	756	5	182
718/560A	207	574	668	2.5	42
719/560A	232	578	733	4	107
70/560A	257	584	798	5	193
708/600A	212	613	717	2.5	39
718/600ACM	185.1	613	717	2.5	54.6
718/600ACM-CB	222	613	717	2.5	54.6
719/600AC	208	620	781	4	123
70/600A	273	624	845	5	230
70/630A	240	659	891	6	275
718/670AC	208	686	804	3	77.5
70/670A	306	699	951	6	345
718/710A/YB2	265	725	855	3	99.9
718/710A/YB2-CB	265	725	855	3	99.9
718/710AC	265	725	855	3	96.4

Single-row Angular Contact Ball Bearing

d 710~1250 mm

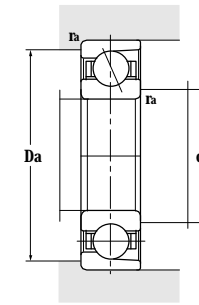
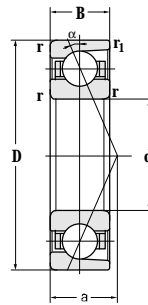

Principal dimensions					Basic load ratings		Limit speed ratings	
d	D	B	r	r ₁	C _r	C _{or}	Grease	Oil
mm					kN		r/min	
710	950	106	6	3	830	2220	450	600
	1030	140	7.5	4	1160	3200	400	530
750	920	78	5	2	630	1850	400	530
	920	78	5	2	610	1510	400	530
	1090	150	7.5	4	1270	3630	350	470
800	1150	155	7.5	4	1320	3780	330	440
850	1030	82	5	2	675	1850	330	440
	1030	82	5	5	670	1800	340	450
	1220	165	7.5	4	1490	4600	290	400
900	1090	85	5	2	670	1830	300	400
	1280	170	7.5	4	1520	4980	270	370
950	1360	180	7.5	4	1590	5150	250	350
1000	1220	100	6	3	830	2460	260	360
	1420	185	7.5	4	1590	5450	210	310
1060	1500	195	9.5	5	1640	5650	200	310
1120	1360	106	6	3	1030	3700	190	290
	1580	200	9.5	5	1680	5800	180	280
1180	1420	106	6	4	865	3650	100	200
	1660	212	9.5	5	1700	6000	170	230
1250	1500	80	6	3	780	2650	180	250
	1500	112	6	3	1110	3900	180	250
	1750	218	9.5	5	1740	6500	160	220
	1750	218	9.5	9.5	1670	5900	160	220

Designations	Contact points a	Abutment and fillet dimensions			Weight kg
		damax	Damax	ramax	
		mm			
719/710AC 70/710A	247	734	926	5	200
	321	739	1000	6	375
718/750AC 718/750A 70/750A	234	768	901	4	112
	234	768	902	4	115
	341	779	1062	6	450
70/800A	359	830	1120	6	510
718/850A 718/850AC 70/850A	312	869	1011	4	141
	312	868	1012	4	140
	381	880	1191	6	605
718/900ACF1 70/900A	274.5	944	1046	4	163
	400	930	1251	6	675
70/950A	424	979	1331	6	800
718/1000A 70/1000A	370	1023	1197	5	239
	442	1029	1390	6	905
70/1060A	467	1095	1465	8	1060
718/1120A 70/1120A	411	1145	1336	5	325
	497	1155	1545	8	1160
718/1180CAF1 70/1180A	356	1225	1377	5	329
	516	1215	1625	8	1340
708/1250A 718/1250A 70/1250A 70/1250BM/P5	437	1275	1476	5	300
	453	1275	1476	5	395
	542	1286	1715	8	1580
	542	1284	1716	8	1738

Matched Pair Angular Contact Ball Bearing

d 20-45 mm

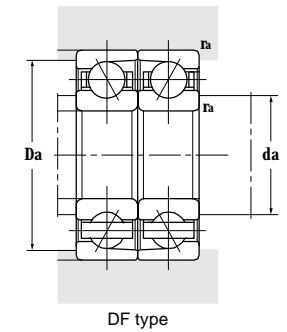
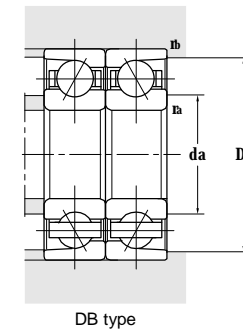
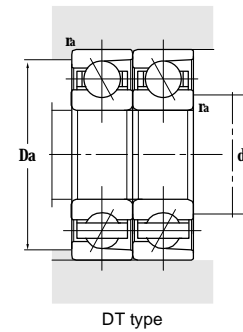
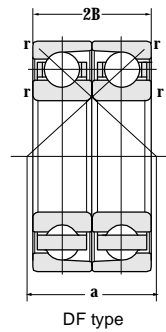
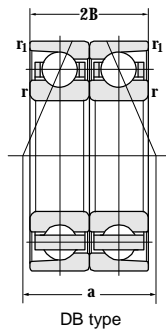
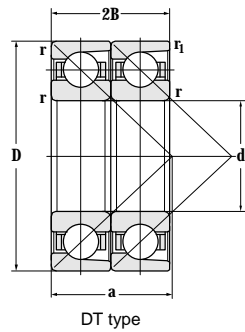

Principal dimensions					Basic load ratings		Limit speed ratings		Designations
d	D	2B	r	r ₁	C _r	C _{or}	Grease	Oil	
mm					kN		r/min		
20	47	28	1	0.6	17.2	28.3	9500	14000	760204TN1/P4DBB
25	52	30	1	0.6	17.5	30.5	8500	12000	760205TN1/P4DBB
	62	34	1.1	0.6	44.0	32.0	7500	10000	7305ACM/DB
	62	34	1.1	1	28.5	41.5	7500	10000	760305TN1/P4DBB
30	62	32	1	0.3	30	24.5	7300	10000	7206BM/DT
	62	32	1.1	1	22.9	44	7300	10000	760206TN1/P4DBB
	62	30	1	0.6	37.5	88	7300	10000	760206X2TN1/P4DT
	62	30	1	0.6	22.9	44	7300	10000	760206X2TN1/P4DFA
	72	38	1.1	0.6	50.0	39	6700	9000	7306ACM/DB
35	62	28	1	0.3	31	27.4	6800	9000	7007C/DB
	72	34	1.1	0.6	48.1	38	6300	8400	7207BTNT/DB
	72	34	1.1	0.6	41.5	34	6300	8400	7207BM/DT
	72	34	1.1	0.6	48	41	6300	8500	7207CHATN1/P4DTCX
	80	42	1.5	0.6	63.1	50	5500	7500	7307AC/DBA
	80	42	1.5	0.6	63.1	50	5500	7500	7307AC/DB
	80	42	1.5	-	62.4	49	5500	7000	7307BM/DFYA3
	80	42	1.5	0.6	62	49	6000	8000	7307BM/DT
	40	90	40	1	0.6	77	187	6000	7500
90		46	1.5	0.6	75	60	5300	7000	7308BM/DB
90		46	1.5	0.6	77.0	62.3	6700	9000	7308AC/DB
90		46	1.5	0.6	76	62	6700	9000	7308ACM/DB
45	85	38	1.1	0.6	56	49	6000	7400	7209BM/DT
	85	38	1.1	0.6	56	49	6000	7400	7209BM/DFCC
	85	38	1.1	0.6	66.5	57.5	6300	7500	7209C/DBA
	85	38	1.5	1.1	34.5	74	5300	7000	760209TN1/P4DBB
	100	50	1.5	0.6	108	88	6000	7000	7309ACM/DB
	100	50	1.5	0.6	97.5	79	5600	6500	7309BM/HADB
	100	50	1.5	0.6	75	80	5600	6500	7309BT/DB
	100	50	1.5	0.6	97.5	79	4800	6300	7309BM/DT
	100	50	1.5	0.6	82.5	79	4800	6300	7309BM/DB
	100	50	1.5	0.6	91.3	88	4800	6300	7309ACM/DB

Contact points			Abutment and fillet dimensions					Weight
DB	DF	DT	d _{amin}	D _{amax}	D _{bmax}	r _{amax}	r _{bmax}	
			mm					kg
21	-	-	25.6	41.4	-	1	0.6	0.263
24	-	-	30.6	46	-	1	0.6	0.3
27	-	-	32	55	-	1	0.6	0.511
27	-	-	32	55	-	1	0.6	0.542
-	-	27.3	35.6	56.5	-	1	-	0.497
27	-	-	35.6	56.4	-	1	0.6	0.443
-	-	47.3	-	-	-	-	-	0.419
-	24.8	-	-	-	-	-	-	0.419
31	-	-	37	65	-	1	0.6	0.661
27	-	-	-	57	-	-	0.6	0.296
61.9	-	-	42	-	67.5	1	0.6	0.571
-	-	31	42	65	-	1	-	0.656
-	-	31	42	65	-	1	1	0.584
47.8	-	-	43.5	-	74.5	1.5	0.6	0.907
47.8	-	-	43.5	-	74.5	1.5	0.6	0.907
-	28.1	-	43.5	-	74.5	1.5	-	1.10
-	-	35	43.5	71.5	-	1.5	-	1.1
39	-	-	49	81	-	1.5	1	1.27
56.5	-	-	49	81	-	1.5	1	1.25
53.5	-	-	49	81	-	1.5	1	1.49
-	-	36.8	52	78	-	1	-	1.97
-	35.5	-	52	78	-	1	-	1.97
37	-	-	52	78	-	1	0.6	0.805
37	-	-	52	78	-	1	0.6	0.978
58.8	-	-	54	-	94	1.5	1	2.03
85.8	-	-	54	-	94	1.5	1	2.03
85.8	-	-	54	-	94	1.5	1	1.83
-	-	43	54	91	-	1.5	n	n
43	-	-	54	91	-	1.5	1	2.02
43	-	-	54	91	-	1.5	1	2.02

Matched Pair Angular Contact Ball Bearing

d 45-60 mm

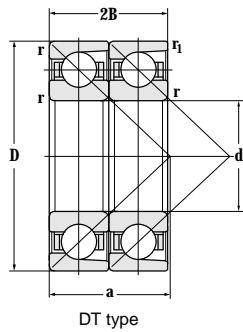

DT type

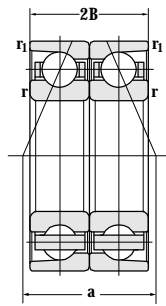

DB type

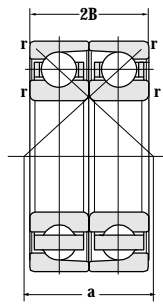

DF type

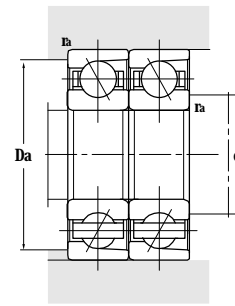

DT type

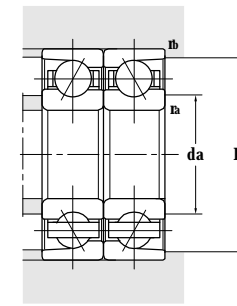

DB type

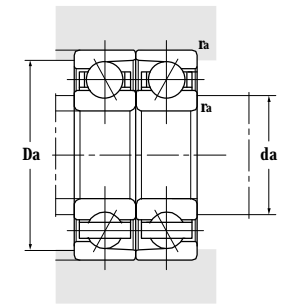

DF type

Principal dimensions					Basic load ratings		Limit speed ratings		Designations
d	D	2B	r	r ₁	C _r	C _{or}	Grease	Oil	
mm					kN		r/min		
45	100	50	1.5	0.6	91.3	88	4800	6300	7309AC/DB 7309BM/DT
	100	50	1.5	0.6	97.5	79	4800	6300	
50	80	32	1	1	41.5	46	10000	14000	7010C/DF
	90	40	1.1	0.6	580	53.5	6400	8500	7210BM/DT
	110	54	2	1	117	98	8200	11000	7310ACM/DB
	110	54	2	1	117	98	8200	11000	7310ACM/DF
	110	54	2	1	117	98	8200	11000	7310AC/DB
	110	54	2	1	113	88	5600	7500	7310BM/DB
	110	54	2	-	113	88	5600	7500	7310BM/DFYA3
	110	54	2	-	122	102	8200	11000	7310CM/DF
55	90	36	1.1	0.6	50.7	51	9200	12000	7011ACQ5/DB
	90	36	1.1	0.6	53	54	9200	12000	7011C/DT
	100	42	1.5	0.6	82	76	4300	5600	7211ACM/DB
	100	42	1.5	0.6	80.5	78	9000	12000	7211CHA/P4ADBA
	120	58	2	1	143	126	4000	5000	7311ACM/DB
	120	58	2	1	143	126	4000	5000	7311AC/DB
	120	58	2	1	127	113	3800	5000	7311BM/DB
	120	58	2	1	127	112	3800	5000	7311BM/DT
	120	58	2	2	143	126	3800	5000	7311ACM/DF
	60	95	36	1.1	0.6	58	60	6000	8000
95		36	1.1	1.1	57	61	6000	8000	7012CHA/P4ADBA
95		36	1.1	0.6	54	58	6000	8000	7012ACHA/P4DTA
95		36	1.1	0.6	54	58	6000	8000	7012ACHATN1/P4DTCX
110		44	1.5	0.6	72.5	98.8	7700	10000	7212C/DT
110		44	1.5	0.6	89.5	86	4000	5300	7212ACM/DB
110		44	1.5	0.6	74	77	4000	5300	7212ACHA/P4DBB
110		44	1.5	0.6	74	77	4000	5300	7212ACHA/P5DBB
110		44	1.5	0.6	74	77	4000	5300	7212ACHA/P5DBB-SJ
130		62	2.1	-	154	134	4000	5000	7312ACM/DF
130		62	2.1	1.1	106	138	5600	7800	7312BT/DB

Contact points			Abutment and fillet dimensions					Weight
DB	DF	DT	d _{amin}	D _{amax}	D _{bmax}	r _{amax}	r _{bmax}	
			mm					kg
58.8			54	91	-	1.5	1	1.83
		73.3	54	91	-	1.5	1	2.02
	1.4				75		0.6	0.489
-	-	39.4	57	83	-	1	-	2.35
64.3	-	-	60	-	104	2	1	2.32
	10.3		60	-	104	2	-	2.41
64.3	-		60	-	104	2	1	2.09
94.1	-	-	60	-	104	2	1	2.35
-	40.1	-	60	100	-	2	-	2.35
-	-5.6	-	60	100	-	2	-	2.41
51.8	-	-	62	-	85	1	0.6	0.947
		28.4	62	85	-	-	-	0.772
57.1	-	-	64	-	91	1.5	1	1.4
41.8	-	-	64	-	91	1.5	1	1.26
69.8	-	-	66	-	109	2	1	3.3
69.8	-	-	66	-	109	2	1	2.88
102.4	-	-	65	-	114	2	1	13.55
-	-	51	66	109	-	2	1	3.22
	51		66	109	-	2	1	3.3
62.7			60		90		0.6	0.785
62.7			60		90		0.6	0.816
			60		90		0.6	0.816
			60		90		0.6	0.815
-	-	22	69	101	-	1.5	-	1.57
47	-	-	69	101	-	1.5	1	1.89
47	-	-	69	101	-	1.5	1	1.86
47	-	-	69	101	-	1.5	1	1.86
47	-	-	69	101	-	1.5	1	1.86
-	13.3	-	72	118	-	2	-	4.05
111	-	-	69	-	127	2	1	1.83

Matched Pair Angular Contact Ball Bearing

d 60-75 mm

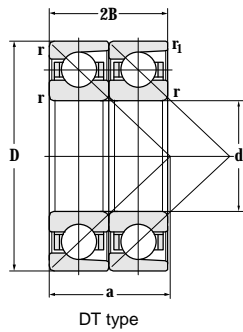

DT type

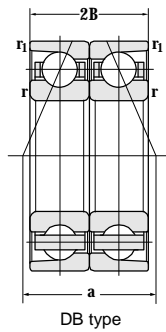

DB type

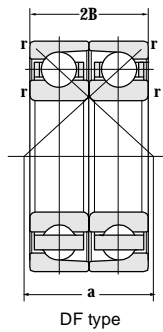

DF type

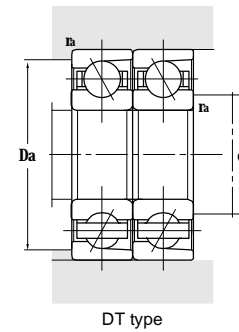

DT type

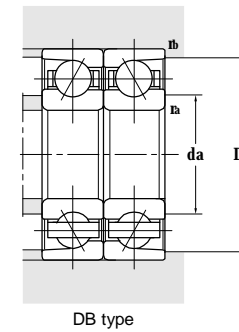

DB type

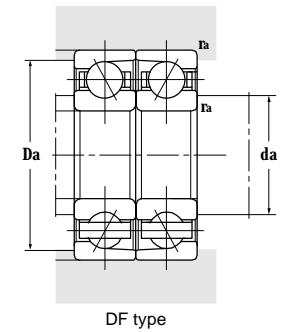

DF type

Principal dimensions					Basic load ratings		Limit speed ratings		Designations
d	D	2B	r	r ₁	C _r	C _{or}	Grease	Oil	
mm					kN		r/min		
60	130	62	2.1	1.1	155	135	3600	4800	7312AC/DB
	130	62	2.1	1.1	179	120	3600	4800	7312BM/DB
	130	62	2.1	1.1	154	134	3600	4800	7312ACM/DB
	130	62	2.1	1.1	154	134	3600	4800	7312ACM/DT
65	100	36	1.1	0.6	54.6	62	7800	10000	7013AC/DT
	100	36	1.1	0.6	48	52	7800	10000	7013AC/DBB
	100	36	1.1	0.6	48	52	7800	10000	7013ACHA/P4DBA
	120	46	1.5	0.6	118	117	7100	9500	7213ACQ5/DBYA3
	140	66	2.1	1.1	186	169	6400	8500	7313AC/DB
	140	66	2.1	1.1	157	169	3200	4300	7313ACM/DB
	140	66	2.1	1.1	165	150	3200	4300	7313BM/DF
	140	66	2.1	1.1	165	150	3200	4300	7313BM/DT
70	110	40	1.1	1.1	58.5	86	6900	9200	7014CM/P5DB
	110	40	1.1	0.6	71.5	82	6900	9200	7014AC/DBB
	110	40	1.1	1.1	58.5	86	7300	9700	7014C/DB
	110	40	1.1	1.1	62	73	7300	9700	7014AHA/P4DBA
	110	40	1.1	0.6	65	75	7300	9700	7014ACHA/P4DBA
	110	40	1.1	1.1	65.0	75.0	7000	9500	7014ACTN1/P4DBA
	125	48	1.5	0.6	124	123	3300	4600	7214ACM/DB
	125	48	1.5	0.6	108	108	3300	4600	7214BM/DT
	150	70	2.1	1.1	186	173	3800	5000	7314BM/DB
	150	70	2.1	-	185	171	3000	4000	7314BM/DT
	150	70	2.1	1.1	209	192	3000	4000	7314ACM/DB
	150	70	2.1	1.1	209	192	3000	4000	7314ACM/DBYA8
	150	70	2.1	2.1	75	82	3000	4000	7314ACM/DF
	180	84	3	3	240	236	2400	3400	7414BM/DF
75	115	40	1.1	1.1	69	83.5	6000	8000	7015ACHATN1/P4DTCX
	130	50	1.5	0.6	112	116	6200	8200	7215BM/DB
	130	50	1.5	0.6	103	113	3200	4300	7215CHATN1/P4DTCX
	160	74	2.1	1.1	228	218	5500	7400	7315ACM/DB

Contact points			Abutment and fillet dimensions					Weight
DB	DF	DT	d _{amin}	D _{amax}	D _{bmax}	r _{amax}	r _{bmax}	
			mm					kg
75.3	-	-	72	-	123	2	1	3.61
55	-	-	72	118	-	2	1	4.28
55	-	-	72	118	-	2	1	4.24
-	-	55	72	118	-	2	-	4.24
-	-	28.2	72	93	-	1	-	0.828
-	-	-	-	-	-	-	-	0.824
-	-	-	-	-	-	-	-	0.811
66.1	-	-	74	-	114	1.5	1	2.43
60	-	-	77	-	133	2	1	4.47
60	-	-	77	128	-	2	1	5.12
-	60	-	77	128	-	2	1	4.96
-	-	76.5	77	128	-	2	1	4.96
62	-	-	77	-	102	1	1	1.45
-	-	-	-	-	-	-	-	1.25
44.1	-	-	77	103	105.5	1	0.6	1.25
44.1	-	-	77	103	105.5	1	0.6	1.27
44.1	-	-	77	103	105.5	1	0.6	1.25
69.5	-	-	71	103	-	-	-	1.24
-	-	-	79	-	116	1.5	1	2.47
86.3	-	52.9	79	116	-	1.5	-	2.54
-	-	-	82	-	143	2	1	6.32
64	-	64	82	138	-	2	-	6.32
64	-	-	82	138	-	2	1	6.27
-	-	-	82	138	-	2	1	6.25
-	64	-	82	138	-	2	1	6.12
62	74	-	86	164	-	2.5	1	11.3
-	-	-	80	-	110	-	0.6	1.29
111	-	-	84	-	124	1.5	1	2.63
-	-	56	84	121	-	1.5	1.5	2.51
91.8	-	-	87	-	153	2	1	7.09

Matched Pair Angular Contact Ball Bearing

d 75–85 mm

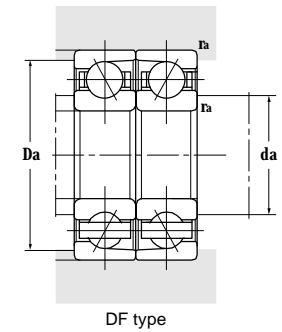
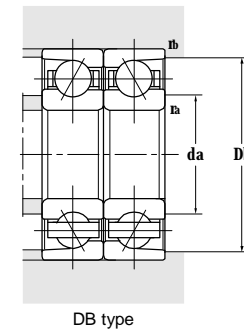
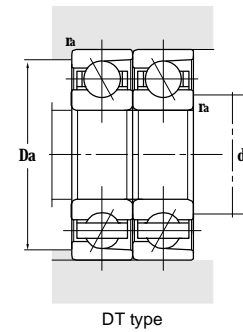
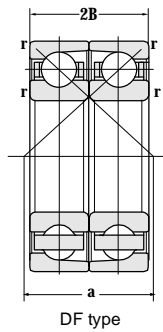
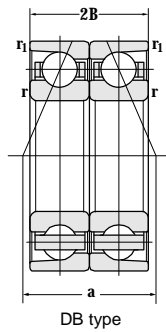
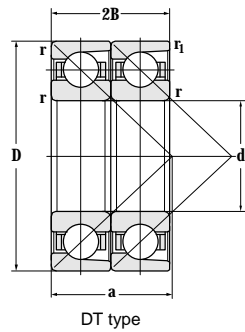

Principal dimensions					Basic load ratings		Limit speed ratings		Designations
d	D	2B	r	r ₁	C _r	C _{or}	Grease	Oil	
mm					kN		r/min		
75	160	74	2.1	1.1	228	218	5500	7400	7315ACM/DT
	160	74	2.1	1.1	228	218	5500	7400	7315ACQ1/DT
	160	74	2.1	1.1	203	194	3600	4800	7315B/DT
	160	74	2.1	1.1	203	194	3600	4800	7315BQ1/P6DTGAS0
	160	74	2.1	1.1	190	218	2800	3800	7315ACM/DB
	160	74	2.1	1.1	202	195	2800	3800	7315BM/DB
	160	74	2.1	2.1	202	194	2800	3800	7315BM/DF
	160	74	2.1	2.1	202	194	2800	3800	7315BM/DT
80	125	44	1.1	0.6	89.7	105	6400	8500	7016ACM/DB
	125	44	1.1	0.6	89.7	105	6400	8500	7016AC/DBB
	125	44	1.1	0.6	83	99	6400	8500	7016ACHA/P5DBA
	125	44	1.1	0.6	79	95	6400	8500	7016AHA/P4DBB
	125	44	1.1	0.6	83	99	6400	8500	7016ACHA/P4DBA-ZH
	140	52	2	1	150	158	6400	8500	7216AC/P4DBB
	140	52	2	1	150	158	6400	8500	7216ACQ5/DBYA3
	140	52	2	1	150	158	3000	4000	7216ACM/DB
	140	52	2	1	107	123	3000	4000	7216ACHA/P5DBB
	170	78	2.1	1.1	246	245	2500	3600	7316ACM/DB
	170	78	2.1	1.1	246	245	2500	3600	7316AC/DB
	170	78	2.1	1.1	220	218	2600	3600	7316BM/DB
	170	78	2.1	2.1	220	218	2600	3600	7316BM/DF
	170	78	2.1	2.1	220	218	2600	3600	7316BM/DT
200	96	3	1.1	320	339	2300	3000	7416AC/DT	
85	130	44	1.1	0.6	84.5	104	4300	5600	7017ACHA/P4DBA
	150	56	2	1	162	174	2800	3800	7217ACM/DB
	150	56	2	1	157	144	2800	3800	7217BM/DB
	180	82	3	1.1	265	273	2400	3400	7317ACM/DB
	180	82	3	1.1	265	275	2400	3400	7317AC/DB
	180	82	3	-	265	273	2400	3400	7317ACM/DF
	180	82	3	1.1	230	240	2400	3400	7317BM/DT

Contact points			Abutment and fillet dimensions					Weight
DB	DF	DT	d _{amin}	D _{amax}	D _{bmax}	r _{amax}	r _{bmax}	
			mm					kg
-	-	45.9	87	148	-	2	-	7.09
-	-	45.9	87	148	-	2	-	7.04
-	-	67.8	87	148	-	2	-	6.51
-	-	67.8	87	148	-	2	-	7.41
68	-	-	87	148	-	2	1	7.3
135.6	-	-	87	148	-	2	1	6.81
-	61.6	-	87	148	-	2	1	6.81
-	-	117	87	148	-	2	1	6.81
69.8	-	-	87	-	120	1	0.6	1.97
69.8	-	-	87	-	120	1	0.6	1.7
69.8	-	-	87	-	120	1	0.6	1.85
69.8	-	-	87	-	120	1	0.6	1.85
69.8	-	-	87	-	120	1	0.6	1.85
59	-	-	91	129	-	2	1	2.97
77.5	-	-	90	-	134	2	1	3.26
77.5	-	-	91	-	129	2	1	3.46
59	-	-	91	129	-	2	1	3.1
97.3	-	-	92	-	158	2	1	8.18
97.3	-	-	92	-	158	2	1	7.17
143	-	-	92	158	-	2	1	8.30
-	65.8	-	92	158	-	2	1	8.30
-	-	124	92	158	-	2	1	8.30
-	-	56.7	94	186	-	2.5	-	14.4
84.1	-	-	90	-	125	-	0.6	1.85
63	-	-	96	139	-	2	1	4.22
64	-	-	96	139	-	2	1	4.53
102.8	-	-	99	-	173	2.5	1	9.78
102.8	-	-	99	-	173	2.5	1	8.7
-	20.8	-	99	166	-	2.5	-	9.78
-	-	76	99	166	-	2.5	2.5	9.78

Matched Pair Angular Contact Ball Bearing

d 85-100 mm

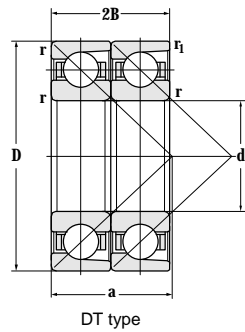

DT type

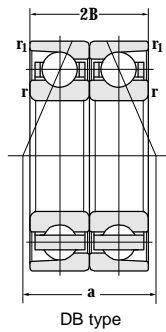

DB type

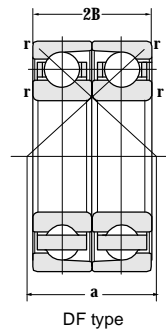

DF type

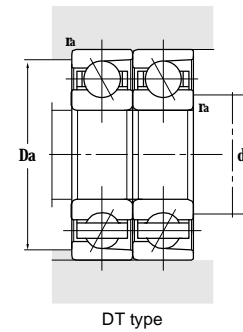

DT type

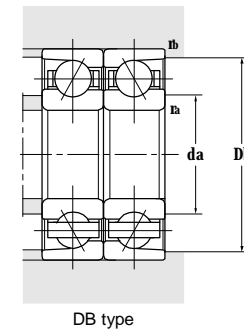

DB type

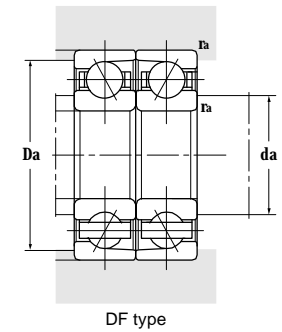

DF type

Principal dimensions					Basic load ratings		Limit speed ratings		Designations
d	D	2B	r	r ₁	C _r	C _{or}	Grease	Oil	
mm					kN		r/min		
85	180	82	3	1.1	236	244	2400	3400	7317BM/DB
	180	82	3	1	265	275	2400	3400	7317ACM/DBYA8
	180	82	3	1.1	230	240	2400	3400	7317BM/DT
90	140	48	1.5	0.6	110	131	3800	5300	7018AC/DBB
	140	48	1.5	0.6	102	125	3800	5300	7018ACHA/P4DBA
	140	45	1.5	1	65	90	3800	5300	SV7018X2ATYN/P4ADBA
	140	48	1.5	0.6	102	125	3800	5300	7018ACHA/P5DBB
	140	48	1.5	0.6	120	145	3800	5300	7018CHA/P4DBA-ZH
	140	48	1.5	0.6	102	125	4500	6300	7018ACTN1/P4DBA
	140	48	1.5	0.6	102	125	4500	6300	7018ACTN1/P5DBA
	160	60	2	1	166	176	3400	4500	7218B/P4DFA
	190	86	3	1.1	250	270	4500	6300	7318BM/DT
	190	86	3	1.1	286	305	4500	6300	7318ACM/DB
95	170	64	2.1	-	215	229	4800	6400	7219ACQ5/DF
	170	64	2.1	1.1	215	228	2400	3400	7219AC/DBB
	200	90	3	1.1	306	335	2000	3000	7319ACM/DB
	200	90	3	1.1	273	300	2000	3000	7319BM/DB
	200	90	3	3	273	300	2000	3000	7319BM/DF
	200	90	3	3	273	300	2000	3000	7319BM/DT
100	150	48	1.5	0.6	111	141	3600	5000	7020AHA/P4DBA
	150	48	1.5	0.6	124	154	3600	5000	7020AC/DBB
	150	48	1.5	0.6	116	146	3600	5000	7020ACHA/DBA
	150	45	1.5	1	69	94	3600	5000	SV7020X2ATYN/P4ADBA
	150	48	1.5	0.6	124	154	3600	5000	7020AC/DB
	150	48	1.5	0.6	116	146	3600	5000	7020ACHA/P4DBB
	150	48	1.5	0.6	118	154	3600	5000	7020ACHA/P4DBB-ZH
	180	68	2.1	1.1	242	260	4600	6100	7220ACM/DB

Contact points			Abutment and fillet dimensions					Weight
DB	DF	DT	d _{amin}	D _{amax}	D _{bmax}	r _{amax}	r _{bmax}	
			mm					kg
76	-	-	99	166		2.5	1	9.78
76			99	166		2.5	1	10
		76	99	166		2.5		10
90.4			96		134		1	2.36
90.4			96		134		1	2.35
90.4			96		134		1	2.48
90.4			96		134		1	2.35
90.4			96		134		1	2.34
77.6			99		133	1.5	0.6	2.34
77.6			99		133	1.5	0.6	2.34
	74.9		105	145		1.5	0.6	4.78
		138.9	104	176		2.5		10.3
108.2	-	-	104	-	173	2.5	1	12.2
-	29.8	-	107	158	-	2	-	5.95
72			107	158		2	1	5.36
84			109	186		2.5	1	13
84	84		109	186		2.5	1	12.6
		61.5	109	186		2.5	1	12.6
	84		109	186		2.5		12.6
96.2					144		1	2.49
96.2					144		1	1.3
96.2					144		1	2.49
96.2					144		1	2.68
96.2					144		1	2.49
96.2					144		1	2.49
96.2					144		1	2.49
96.2					144		1	2.55
99.3	-	-	112	-	173	2	1	7.14

Matched Pair Angular Contact Ball Bearing

d 100~120 mm

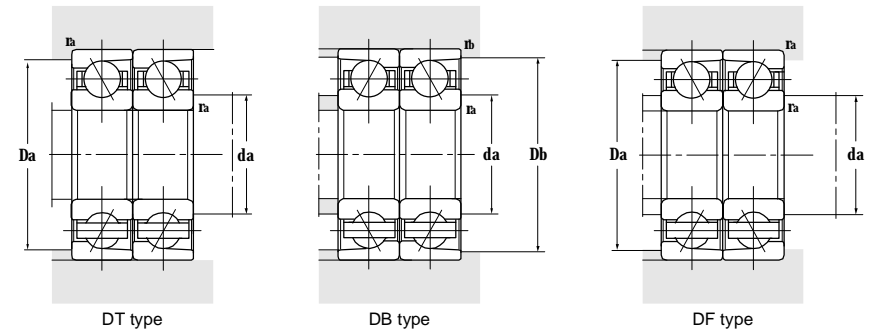
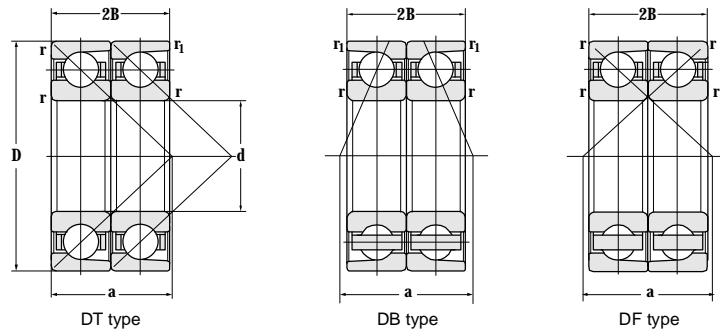

Principal dimensions				Basic load ratings		Limit speed ratings		Designations	
d	D	2B	r	r ₁	C _r	C _{0r}	Grease		Oil
mm				kN		r/min			
100	215	94	3	-	345	395	1900	2800	7320ACM/DF
	215	94	3	-	305	355	1900	2800	7320BM/DF
	215	94	3	1.1	309	354	1900	2800	7320BT/DT
	215	94	3	1.1	345	395	1900	2800	7320ACM/DB
	215	94	3	1.1	310	355	1900	2800	7320BM/DB
105	225	98	3	1.1	330	390	1800	2600	7321BM/DB
	225	98	3	3	330	390	1800	2600	7321BM/DF
110	170	56	2	1	165	213	4500	6300	7022CM/DBYA3
	200	76	2.1	1.1	299	342	4100	5500	7222CM/DB
	200	76	2.1	1.1	286	325	2000	3000	7222ACM/DB
	200	76	2.1	1.1	250	289	4000	6000	7222BM/P5DBC
	200	76	2.1	1.1	299	340	1900	2800	7222CM/DB
	200	76	3	1.1	250	289	1900	2800	7222BM/DB
	240	100	3	-	347	425	1700	2400	7322BM/DF
	240	100	3	1.1	385	465	1700	2400	7322ACM/DB
	240	100	3	3	385	465	1700	2400	7322ACM/DF
	240	100	3	1.1	385	465	1700	2400	7322ACM/DT
120	180	56	2	-	164	214	4200	5600	7024AC/DF
	180	56	2	1	140	185	2000	2900	7024BM/DT
	180	56	2	1	148	199	1900	2800	7024AHA/P4DBA
	180	56	2	1	153	206	1900	2800	7024ACHA/P4DBB
	180	56	2	1	153	206	1900	2800	7024ACHA/P4DTA
	180	54	1	1	153	205	1900	2800	SV7024X2ATN1/P4ADBA
	180	54	1	1	153	205	1900	2800	SV7024X2ATYN/P4ADBA
	215	80	2.1	1.1	307	367	3800	5000	7224ACQ5/DB
	215	80	2.1	1.1	300	367	1700	2400	7224ACM/DB-SH
	215	80	2.1	2.1	300	367	1700	2400	7224ACM/DF
	260	110	3	-	400	540	1600	2200	7324AC/DF

Contact points			Abutment and fillet dimensions					Weight
DB	DF	DT	d _{amin}	D _{amax}	D _{bmax}	r _{amax}	r _{bmax}	
			mm					kg
-	26.5	-	114	201	-	2	-	19.2
-	85.2	-	114	201	-	2	-	16.8
-	-	89.6	114	201	-	2.5	-	15.2
90	-	-	114	201	-	2.5	1	19.4
76	-	-	112	168	-	2	1	16.8
94	-	-	119	211	-	2.5	1	19
-	94	-	119	211	-	2.5	1	19
65.5	-	-	-	-	164	-	1	4.82
79.5	-	-	122	-	188	2	1	10.0
103.3	-	-	122	-	188	2	1	9.47
167.9	-	-	122	-	188	2	1	7.92
84	-	-	122	188	-	2	1	9.67
85	-	-	122	188	-	2	1	7.92
-	98.5	-	124	226	-	2.5	-	23.5
99	-	-	124	226	-	2.5	1	19.9
-	99	-	124	226	-	2.5	1	20.4
-	-	99	124	226	-	2.5	-	20.4
-	42	-	130	170	-	2	-	4.62
-	-	77	130	170	-	2	-	-
77	-	-	129	171	-	2	1	4.27
77	-	-	129	171	-	2	1	4.27
-	-	77	129	171	-	2	1	4.27
77	-	-	129	171	-	2	1	4.16
77	-	-	129	171	-	2	1	4.16
118.1	-	-	132	-	208	2	1	13.1
90	-	-	132	203	-	2	1	12.3
-	90	-	132	203	-	2	1	12.3
-	33.6	-	134	246	-	2.5	-	27.4

Matched Pair Angular Contact Ball Bearing

d 120~160 mm

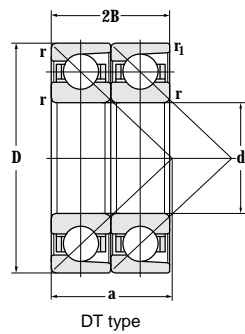

DT type

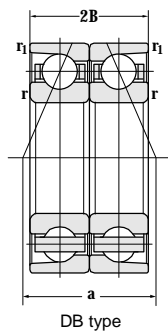

DB type

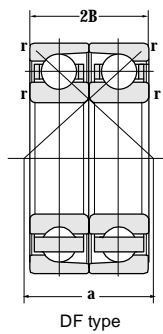

DF type

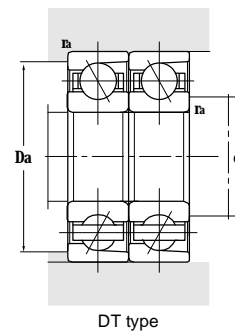

DT type

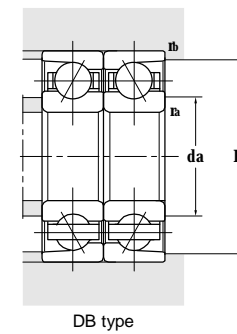

DB type

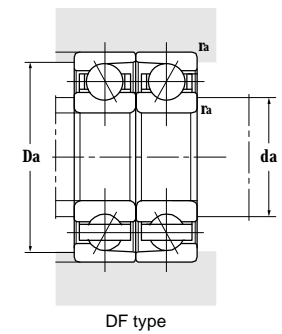

DF type

Principal dimensions					Basic load ratings		Limit speed ratings		Designations
d	D	2B	r	r ₁	C _r	C _{or}	Grease	Oil	
mm					kN		r/min		
120	260	110	3	1.1	410	525	3300	4500	7324B/DT 7324AC/DB 7324B/DF
	260	110	3	1.1	430	540	1600	2200	
	260	110	3	3	405	525	1600	2200	
130	180	48	1.5	0.6	130	190	3400	4800	71926ACM/DT 7026AC/DT SV7026X2ATYN/P4ADBA 7226BM/P5DBCB 7226ACM/DB 7226ACM/DF 7326B/DF 7326B/DT 7326ACM/DB 7226BM/DT 7226BM/DF 7226C/P4DFA
	200	66	2	1	198	260	2600	3600	
	200	63	2	1	126	179	2600	3600	
	230	80	3	1.1	278	350	1800	2600	
	230	80	3	1.1	320	400	1700	2400	
	230	80	3	3	320	400	1700	2400	
	280	116	4	-	403	537	1600	2200	
	280	116	4	1.5	403	537	1600	2200	
	280	116	4	1.5	455	605	1500	2000	
	230	80	3	1.1	278	350	1800	2600	
	230	80	3	1.1	278	350	1800	2600	
	230	80	3	1.1	335	420	1900	2800	
140	210	66	2	-	203	275	3600	4800	7028AC/DF 7228ACM/DB-SH 7228BM/DB 7228BM/DT 7228BM/P5DBCB 7328B/DT 7328BA/DT 7328B/DB 7328B/DF
	250	84	3	1.1	355	470	1600	2200	
	250	84	3	1.1	309	414	1700	2300	
	250	84	3	1.1	309	414	1700	2300	
	250	84	3	1.1	310	415	1700	2300	
	300	124	4	1.5	447	616	1600	2000	
	300	124	4	1.5	445	600	1600	2000	
	300	124	4	1.5	445	600	1400	1900	
	300	124	4	1.5	445	600	1400	1900	
	300	124	4	4	445	600	1400	1900	
150	225	70	2.1	1.1	213	294	1700	2300	7030BM/DB 7030X2BM/P4ADBA 7230B/DF 7230BM/DB 7330AC/DF 7330B/DF
	225	67.5	2.1	1.1	213	194	1600	2200	
	270	90	3	-	310	430	1600	2000	
	270	90	3	1.1	582	857	1500	2000	
	320	130	4	-	582	856	2600	3600	
	320	130	4	-	582	856	2600	3600	
	320	130	4	-	582	856	2600	3600	
160	229.5	66	3	1.5	151	256	3000	4000	72932X3BM/DBYA6 7032BM/DB
	240	76	2.1	1.1	225	315	3100	4100	

Contact points			Abutment and fillet dimensions					Weight
DB	DF	DT	d _{amin}	D _{amax}	D _{bmax}	r _{amax}	r _{bmax}	
			mm					kg
-	-	107.2	134	246	-	2.5	-	29.2
107	107	-	134	246	-	2.5	1	27.4
-	-	-	134	246	-	2.5	1	29.2
96.3	-	-	-	-	174	-	1	3.78
-	-	-	-	-	194	-	1	6.75
-	-	-	-	-	194	-	1	6.76
191	-	-	144	-	216	2.5	1	15.1
96	-	-	144	216	-	2.5	1	14
-	96	-	144	216	-	2.5	1	14
-	114	-	148	262	-	3	-	35.9
-	-	115.1	148	262	-	3	-	35.9
115	-	-	147	263	-	3	1.5	36.1
-	-	171	152	209	-	2.5	1	15.1
111	-	-	152	209	-	2.5	1	15.1
-	8	-	148	213	-	2.5	1	12.5
-	48.6	-	150	200	-	2	-	6.92
103	-	-	154	236	-	2.5	1	16.9
205.8	-	-	154	-	243	2.5	1	17.2
-	-	184.8	154	228	-	2.5	1	17.2
205.6	-	-	154	-	243	2.5	1	17.2
-	-	123.2	158	282	-	3	-	42.3
-	-	123	158	282	-	3	-	42.3
123	-	-	157	283	-	3	1.5	42.3
-	123	-	157	283	-	3	1.5	42.3
192.3	-	-	160	-	215	2	1	9.61
96	-	-	160	215	-	2	1	9.57
-	132	-	165	256	-	2.5	-	22
111	-	-	164	256	2.5	23.7	-	23.4
-	45.3	-	168	302	-	3	-	51.6
-	132	-	168	302	-	3	-	52.3
78.9	-	-	172	-	214	2	1	9.06
205.8	-	-	172	-	233	2	1	12

Matched Pair Angular Contact Ball Bearing

d 160~200 mm

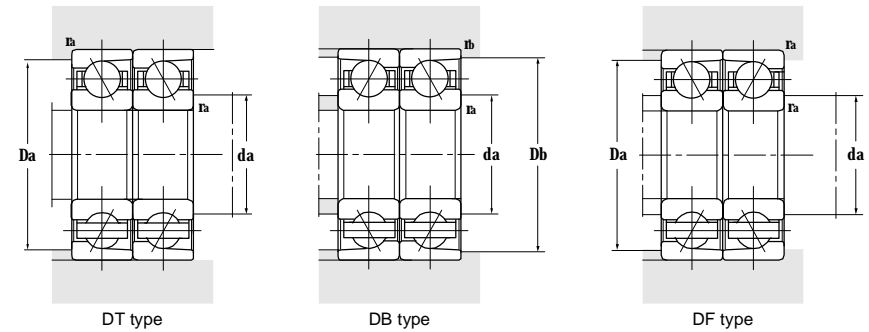
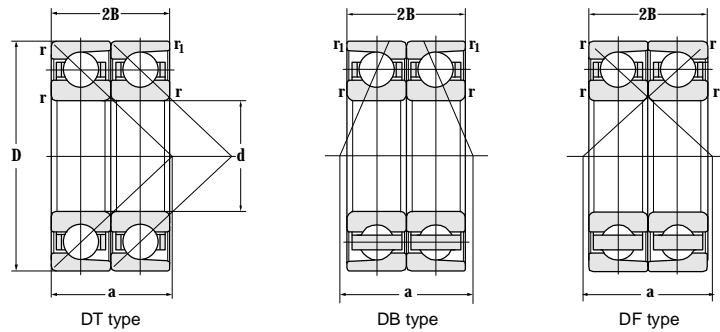

Principal dimensions					Basic load ratings		Limit speed ratings		Designations
d	D	2B	r	r ₁	C _r	C _{or}	Grease	Oil	
mm					kN		r/min		
160	290	96	3	1.1	400	580	1300	1800	7232AC/DB
	290	96	3	1.1	340	500	1400	1900	7232B/DB
	290	96	3	1.1	340	500	1400	1900	7232B/DT
	290	96	3	3	400	580	1300	1800	7232AC/DF
	290	96	3	3	340	500	1300	1800	7232B/DF
170	229.5	56	2	-	147	225	3600	4800	71934X1B/DFYA3
	260	84	2.1	1.1	310	435	1500	2000	7034A/C2DB
	260	84	2.1	1.1	272	380	1500	2000	7034B/DB
	310	104	4	1.5	462	685	2900	3900	B7234AC/DT
	310	104	4	1.5	495	740	1800	2500	7234AC/DT
	310	104	1	1.5	495	740	1200	1700	7234AC/DB
	360	144	4	1.5	570	905	1000	1500	7334B/DB
180	280	92	2.1	1.1	310	485	1200	1700	7036B/DT
	280	92	2.1	1.1	355	525	1300	1800	7036CHA/P4DBA
	320	104	4	-	400	645	1000	1500	7236B/DF
	380	150	4	2	590	970	1000	1400	7336B/DT
190	260	66	2	1	162	274	2400	3400	71938CTYN/P5DBAX
	260	66	2	1	162	274	2400	3400	71938C/P5DBAX
	290	92	2.1	1.1	347	526	2600	3400	7038AC/DT
	290	92	2.1	1.1	218	262	1200	1700	7038AC/DT
	400	156	5	2	640	1100	900	1400	7338B/DT
200	280	76	2	1	310	480	2200	3200	71940A/DB
	280	76	2.1	1.1	200	330	2200	3200	71940CTYN/P4ADBAX
	280	76	2.1	1.1	200	330	2200	3200	71940C/P4ADBAX
	280	76	2.1	1.1	200	330	2200	3200	71940ACHA/P4DBB
	289.5	76	3.5	2	232	420	2200	3200	71940X1B/DBYA6
	310	102	2.1	1.1	370	575	1600	2100	7040B/DB
	360	116	4	1.5	503	834	2200	3000	7240B/DB
	360	116	4	-	589	974	2200	3000	7240C/DF
	360	11	4	-	728	920	2200	3000	7240AC/DF

Contact points			Abutment and fillet dimensions					Weight
DB	DF	DT	d _{amin}	D _{amax}	D _{bmax}	r _{amax}	r _{bmax}	
			mm					kg
118	-	-	174	276	-	2.5	1	29
236.8	-	-	174	-	276	2.5	1	27.8
		212.8	174	264		2.5	-	27.8
	118		174	276		2.5	1	29
	118		174	276		2.5	1	27.8
-	139	-	168	225	-	1.5	-	7.04
166.2	-	-	181	-	249	2	1	15.6
222.6	-	-	181	-	249	2	1	16.6
-	-	82	181	249	-	3	-	34.8
-	-	82	181	249	-	3	-	34.1
127	-	-	187	293	-	3	1.5	34.1
294	-	-	188	-	351.5	3	1.5	69.8
-	-	119	192	269	-	2	-	21
119	-	-	191	269	-	2	1	19
-	158	-	198	304	-	3	-	35
-	-	156	198	362	-	3	-	81
93.3	-	-			254		1	9.58
93.3	-	-			254		1	9.58
-	-	79	202	278	-	2	-	21.4
-	-	124	201	279	-	2	-	21.5
-	-	164	210	380	-	4	-	97
102	-	-			273		1	14.7
102	-	-			273		1	6.76
102	-	-			273		1	13.4
102	-	-			273		1	13.5
102	-	-			273		1	16.9
265	-	-	211	-	299	2	1	28.3
292.9	-	-	218	-	351	3	1.5	51.6
-	17	-	218	342	-	3	-	50.3
-	72.6	-	218	342	-	3	-	50.3

Matched Pair Angular Contact Ball Bearing

d 200~420 mm

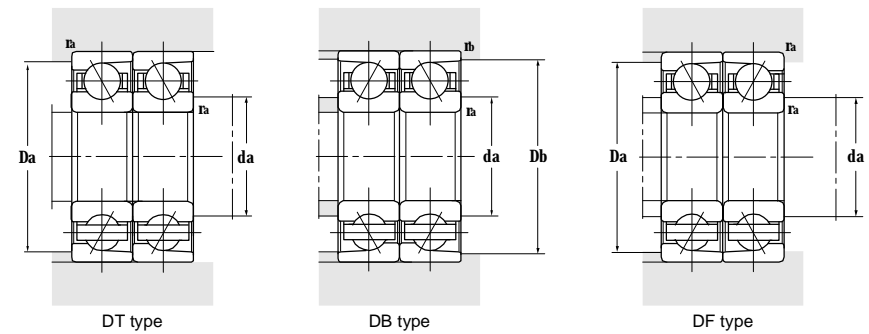
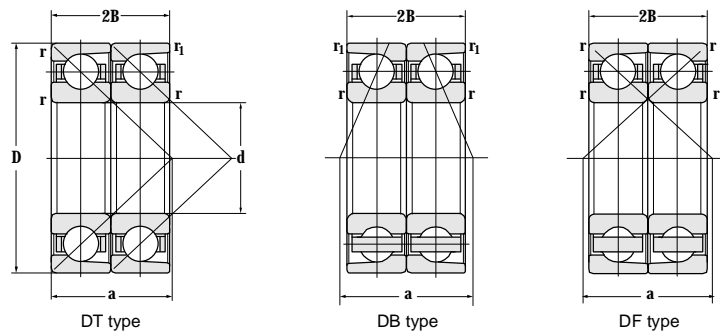

Principal dimensions				Basic load ratings		Limit speed ratings		Designations	
d	D	2B	r	r ₁	C _r	C _{or}	Grease		Oil
mm				kN		r/min			
200	360	116	4	1.5	560	920	1300	1800	7240AC/DB 7340B/DT
	420	160	5	2	720	1270	900	1200	
220	300	76	2.1	1.1	275	475	1100	1600	71944C/P5DBBX 7044B/DB 7244B/DB 7344B/DF
	340	112	3	1.1	400	700	900	1300	
	400	130	4	1.5	505	910	900	1200	
	460	176	5	-	800	1450	800	1200	
230	329.5	80	2.1	1.1	358	605	900	1200	7646AMB/DB 7646AMB/DB/W281
	329.5	80	2.1	1.1	360	605	900	1200	
240	320	76	2.1	1.1	305	510			71948C/P4DBBX 7048B/DF 366748K
	360	112	3	-	410	760	900	1200	
	370	112	3	-	-	-	-	-	
260	360	92	2.1	-	277	630	1300	1800	71952B/DF 7052B/DF/W281 7052B/DF
	400	130	4	4	520	970	1000	1500	
	400	130	4	4	520	970	1000	1500	
280	380	92	2.1	1.1	436	810	950	1400	71956AC/DB 71956A/DBA 7056B/DB
	380	92	2.1	1.1	410	745	950	1400	
	420	130	4	1.5	490	1000	800	1000	
310	429.5	120	3	1.1	460	890	800	1100	71962X3B/DB 71962X3B/DB/W281
	429.5	120	3	1.1	460	890	800	1100	
340	520	164	5	-	725	1620	660	900	7068B/DF
360	440	76	2.1	1.1	365	840	1500	1900	71872AC/DB 71972AC/DB
	480	112	3	3	560	1250	740	1000	
380	480	92	2.1	1.1	359	730	700	910	71876B/DB 71976AC/DT
	520	130	4	4	640	1470	700	910	
420	620	180	5	2	850	2130	520	700	7084B/DT

Contact points			Abutment and fillet dimensions					Weight
DB	DF	DT	d _{amin}	D _{amax}	D _{bmax}	r _{amax}	r _{bmax}	
			mm					kg
146			217	343		3	1.5	50.3
-		170	220	400	-	4	-	108
129	-	-	229	-	295	2	1	14.1
290	-	-	234	-	325	2.5	1	36.5
328	-	-	238	-	384	3	1.5	70.6
-	198	-	240	440	-	4	-	142
201.6	-	-	245	-	321	2	1	22.7
202.6	-	-	246	-	321	2	1	22.7
								14.6
-	196	-	255	345	-	2.5	-	39
-	199.9	-	254	356	-	2.5	-	48.7
								28.8
-	214	-	272	348	-	2	-	60
	171		277	383		1.5	3	60
	171		277	383		1.5	3	60
200	-	-	292	-	372	2	1	31.4
236.6	-	-	290	-	370	2	1	33.2
358	-	-	298	-	404	3	1.5	60
								52.2
								52.2
-	282	-	360	500	-	4	-	124
224	-	-	372	-	430	2	1	24
252	-	-	374	-	465	2.5	2.5	57.5
601	-	-	392	-	473	2	1	37.2
-	-	137	396	505	-	3	-	83.5
-	-	263	439	602	-	4	-	176

Matched Pair Angular Contact Ball Bearing

d 440~1320 mm

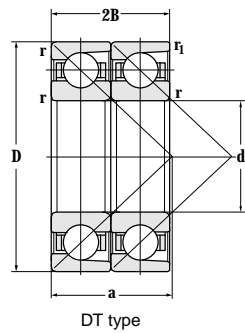

DT type

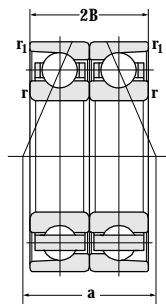

DB type

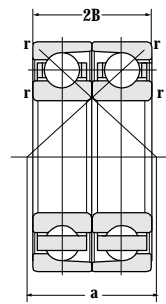

DF type

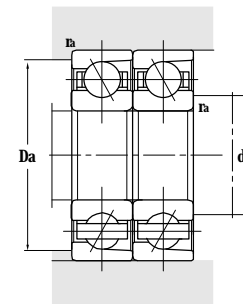

DT type

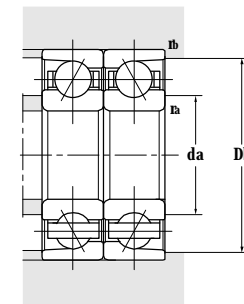

DB type

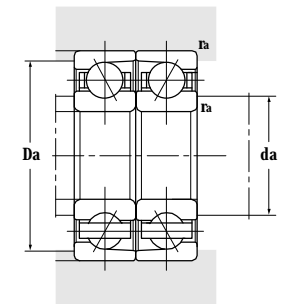

DF type

Principal dimensions				Basic load ratings		Limit speed ratings		Designations	
d	D	2B	r	r ₁	C _r	C _{or}	Grease		Oil
mm				kN		r/min			
440	650	188	6		885	2190	500	650	7088BM/DF
460	580	112	3	3	580	1530	610	810	71892A/DT
500	620	74	2.1	-	430	1230	520	700	708/500A/DF
	670	156	5	2	86	860	500	660	719/500A/DT
530	615	70	3	1.1	210	520	630	824	718/530X3AC/P5DB
	650	112	3	-	620	1810	510	680	718/530A/DF
	650	112	3	1.1	645	1850	510	680	718/530AC/DB
	710	164	5	2	1030	2530	500	700	719/530A/DB
	710	164	5	2	845	2210	600	800	719/530B/DT
560	680	112	3	1.1	635	1850	470	620	718/560A/DT
	750	170	5	2	970	2680	470	620	719/560A/DB
600	730	120	3	3	740	2330	790	1100	718/600AC/DB
670	820	138	4	1.5	830	2510	380	500	718/670A/DT
710	870	148	4	-	955	3240	370	480	718/710AC/DF
	950	212	5	2	1370	4500	640	850	719/710AC/DB
750	920	156	5	-	985	3450	310	420	718/750A/DF
1000	1420	260	7.5	2	2340	9250	190	250	70/1000X2AF3/P69DF
1180	1420	212	6	4	1410	7300	180	270	718/1180ACM/DB
	1420	212	6	4	1410	7300	180	270	718/1180ACF3/DF
1320	1600	244	6	-	1930	8230	200	300	718/1320ACF3/DF

Contact points			Abutment and fillet dimensions					Weight kg
DB	DF	DT	d _{amin}	D _{amax}	D _{bmax}	r _{amax}	r _{bmax}	
			mm					
	263		461	548		4		221
-	-	178	474	567	-	2.5	-	68
-	286	-	512	610	-	2	-	54.5
-	-	208	519	653	-	4	-	154
296.7	-	-	544	-	608	2.5	1	37.1
-	285	-	544	638	-	2.5	-	77
331	-	-	544	-	638	2.5	1	77
440	-	-	552	-	700	4	2	189
-	-	186	558	692	701	4	2	191
-	-	207	575	667	-	2.5	-	95
463			612	697				218
370	-	-	614	-	718	2.5	2.5	94.5
-	-	250	686	806	-	3	-	156
-	294	-	726	856	-	3	-	192
494	-	-	734	-	926	5	2.5	389
-	404	-	768	902	-	4	-	220
-	220	-	1020	1400			7	1400
495			1250		1400		5	669
	500		1235	1365				657
-	558.9	-	1348	1572	-	5	-	987

Double-row Angular Contact Ball Bearing

d 25–80 mm

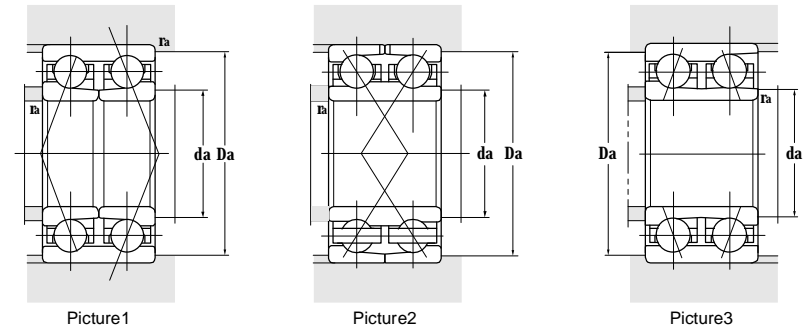
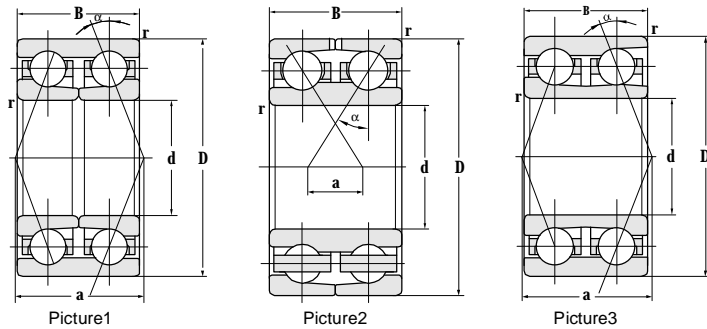

Principal dimensions				Basic load ratings		Limit speed ratings	
d	D	B	r	C _r	Cor	Grease	Oil
mm				kN		r/min	
25	52	20.6	1	16.1	11.8	6500	8000
	62	25.4	1.1	26.0	17.9	6500	8000
30	62	23.8	1	28.6	20.8	7000	9500
35	72	27	1.1	32.5	35.0	6500	8000
	72	27	1.1	37.7	27.5	6000	8000
	80	34.9	1.5	52	48.0	5600	7500
40	80	30.2	1.1	48	41	5600	7500
	90	36.5	1.5	57.5	55.0	5300	6700
45	85	30.2	1.1	50.7	46.0	5000	6700
	85	30.2	1.1	50.7	46.0	5000	6700
	100	39.7	1.5	63	68.0	4800	6300
50	110	44.4	2	75	83.0	4300	5600
55	100	33.3	1.5	54.0	47.0	4500	5800
60	110	36.5	1.5	82.6	81.0	3800	5000
65	120	38.1	1.5	91.0	96.0	3600	4500
	120	38.1	1.5	51.0	60.0	3600	4500
	140	58.74	2.1	164	150	3200	4300
	140	58.7	2.1	135	146	3200	4300
70	150	63.5	2.1	180	168	3200	4300
75	130	41.3	1.5	111	119	3200	4300
	130	41.3	1.5	107	115	3200	4300
	160	68.3	2.1	208	197	3000	4100
	160	68.3	2.1	203	191	3000	4100
80	170	68.3	2.1	221	216	2800	3600

Designations	Contact points a	Abutment and fillet dimensions			Weight kg
		damin	Damax	ramax	
		mm			
3205ATN1	31.7	31.3	46	1	0.185
3305ATN1	36.2	33	54	1	0.359
3206ATN1-2RS	36.5	36.5	57	1	0.293
3207M	46.3	39	68	1	0.51
3207ATN1	42.5	43	64	1	0.457
3307M	49	44	71	1.5	0.87
3208M	47	47	73	1	0.68
3308M	52	49	81	1.5	1.1
3209M	53.5	52	78	1	0.719
3209F1/C3	53.5	52	78	1	0.710
3309M	58	54	91	1.5	1.540
3310M	64	61	99	2	2.040
3211ATN1/V1	60.2	63	96	1.5	0.990
3212M	69.7	69	101	1.5	1.47
3213YM	64.7	74	111	1.5	1.84
3213ATN1/V1	71.8	74	111	1.5	1.70
3313DYM	79.4	77	128	2	4.89
3313M	86	77	128	2	4.34
3314	97.4	87	137	2	5.26
3215DYM	70.6	84	121	1.5	2.81
3215	73	84	121	1.5	2.09
3315DYM	91.5	87	148	2	6.82
3315	103.8	87	148	2	6.27
3316M	105.6	92	158	2	7.21

Double-row Angular Contact Ball Bearing

d 85-180 mm

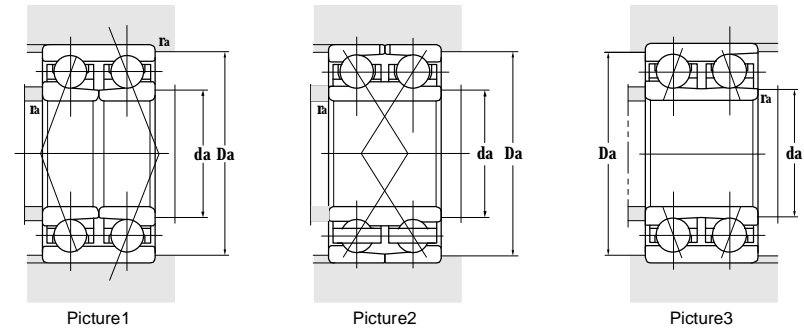
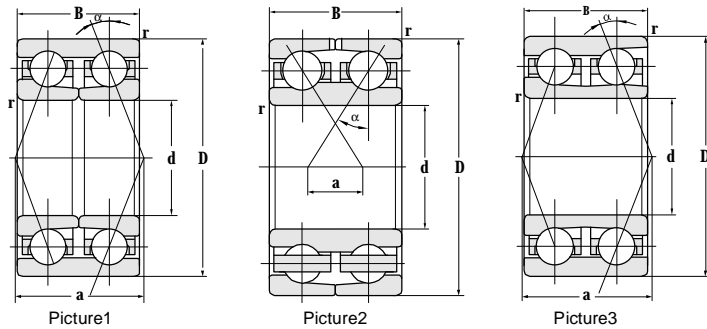

Principal dimensions				Basic load ratings		Limit speed ratings	
d	D	B	r	C _r	C _{or}	Grease	Oil
mm				kN		r/min	
85	140	48	2	114	101	2200	3200
100	180	60.3	2.1	198	215	2000	2700
110	240	92.1	3	358	429	1800	2400
120	190	66	2	179	237	2500	3600
130	200	75	2	150	200	2200	3200
150	215	50	2	126	188	1600	2200
	225	73	2	199	275	2200	3200
	230	70	2.1	185	250	2200	3200
	230	70	2.1	185	250	2200	3200
160	240	76	2.1	225	315	1900	2500
	240	80	2.1	210	289	1900	2500
	240	80	2.1	210	289	1900	2500
	240	80	2.1	209	289	1500	2000
	240	80	2.1	209	289	1500	2000
	240	80	2.1	209	289	1500	2000
170	259.5	84	2.1	250	355	1600	2100
	259.5	84	2.1	250	355	1600	2100
	260	84	2.1	207	385	1600	2100
	260	90	2.1	250	355	1600	2100
	260	90	2.1	250	355	1400	1900
180	259.5	66	2.1	281	313	1400	1800
	259.5	66	2.1	216	312	1400	1800
	259.5	66	2.1	281	313	1400	1800
	280	92	2.1	275	400	1300	1800
	280	92	2.1	275	400	1300	1800
	280	100	2.1	275	400	1300	1700
	280	100	2.1	275	400	1300	1700
	280	100	2.1	275	400	1300	1700

Designations	Contact points a	Abutment and fillet dimensions			Weight kg
		damin	Damax	ramax	
		mm			
3217X3DATN1/C3	25.9	43	64	2	2.39
3220YM	129.5	112	168	2	6.46
3322M	151	124	226	2.5	19.9
4024X3DM/W34	130.1	133	175.8	2	6.78
4026X2DM	202.5	140	190	2	8.29
4932X3DM	185	171	207	2	5.15
4030X2DYM/YA6W34	193.8	164	212	2	6.78
4030X3DM	200.1	162	218	2	10.7
4030X3DM/W33	194	161	219	2	10.6
4032X2M/DCYA1	129.9	172	228	2	12.5
4032DM	240	172	228	2	11.6
4032DM/C91W33A	239.8	172	228	2	11.5
4032DM	130	172	228	2	12
4032DM/W33	130	172	228	2	11.6
4032DM/C9W33A	130	172	228	2	11.5
4034X3DM	258	188	241	2	15.3
4034X3DM/W33	258	188	241	2	15.3
4034X2BM/YA1	138.5	182	248	2	16.1
4034DM	260	182	248	2	16.1
4034D/W33	111	181	249	2	16.1
4936X3DM	253	192	248	2	11.1
4936X3DM/W33	253	192	248	2	10
4936X3DM/W34	253	192	248	2	11
4036DMX2/W33	147	192	268	2	20.9
4036X2DN1/W33	147	192	268	2	20.9
4036DM/C9W33	280	192	268	2	22.4
4036DM/W33	280	192	268	2	22.4

Double-row Angular Contact Ball Bearing

d 190~530 mm

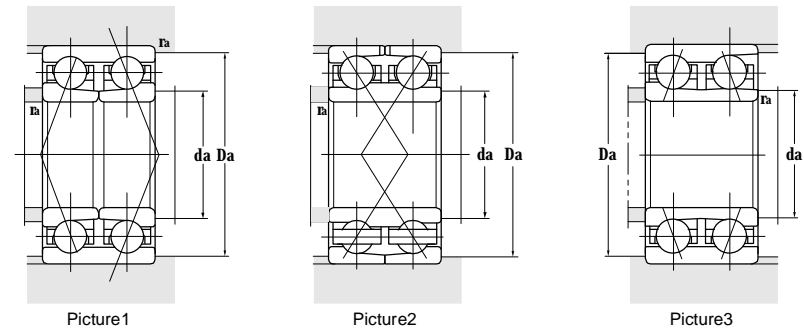
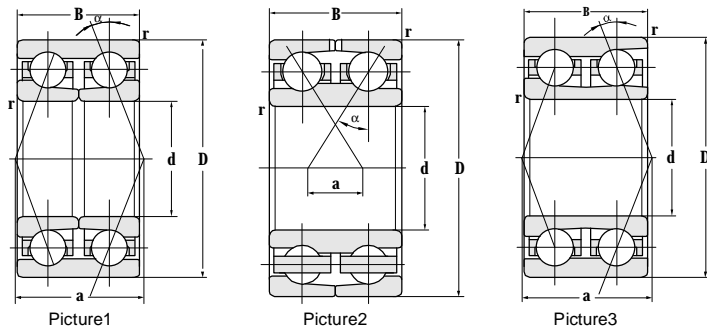

Principal dimensions				Basic load ratings		Limit speed ratings	
d	D	B	r	C _r	C _{or}	Grease	Oil
mm				kN		r/min	
190	269.5	66	2.1	220	324	1350	1700
	269.5	66	2.1	220	324	1350	1700
	290	100	2.1	308	470	1200	1700
200	310	109	2.1	343	538	1200	1600
	310	96	3	370	575	1100	1600
220	309.5	76	2.1	250	381	1100	1500
	309.5	76	2.1	250	380	1000	1500
	340	118	3	359	596	1000	1400
	340	118	3	385	645	1000	1400
230	329.5	80	1.1	340	570	950	1400
	329.5	80	1.1	340	570	950	1400
240	360	118	3	470	650	900	1250
	359.5	118	3	376	648	900	1250
	359.5	118	3	470	650	900	1250
260	369.5	92	4	373	662	800	1200
	369.5	92	4	373	662	800	1200
	400	130	4	470	855	800	1100
	400	140	4	450	830	800	1100
	400	140	4	450	830	800	1100
	400	140	4	450	830	850	1200
280	389	92	4	380	670	750	1100
	389.5	92	4	377	683	750	1100
	420	140	4	500	950	750	1100
300	419.5	112	2.1	423	791	700	1000
	460	160	4	569	1149	640	960
	460	160	4	470	1260	640	960
320	440	112	2.1	460	920	630	850
	778	224	3	1150	3400	400	520

Designations	Contact points a	Abutment and fillet dimensions			Weight kg
		damin mm	Damax	ramax	
4938X3DM	262.7	202	258	2	11.5
4938X3DM/W34	262.7	202	258	2	11.5
4038DM/W34	155	202	278	2	23
4040DM/W34	309.5	212	298	2	28.0
4040X2DCM/YA3	166	214	296	2.5	26.3
4944X3DM	303	232	298	2	18.0
4944X3DM/W33	204	232	297	2	17.9
4044DM/W34	339	234	326	2.5	36.7
4044/DCYA1	118	234	326	2.5	37.5
4646DCM/YA3	214	242	317	2	22.8
4646DCM/YA3-1	214	242	317	2	22.5
4048DM/W33	359	254	346	2.5	42.8
4048X1DM/W34	359	254	346	2.5	44.9
4048X1DM/C9W33	359	254	346	2.5	42.5
4952X3DM/W34	361	278	352	3	31.3
4952X3DM	361	278	352	3	31.3
4052X2/DCYA1	212	278	382	3	60.2
4052DM	400	278	382	3	60.7
4052DM/C9W33	400	278	382	3	60.7
4052DM/C9	212	383	3	3	60.7
4056X3D	381	298	372	3	32.9
4956X3DM/W34-1	381	298	372	3	34.0
4056D/W33	258	292	377	2	66.3
4960X3DM	416	342	408	2	43.0
4060DYM	398.6	348	442	3	97.9
4060D/W34	398.6	348	442	3	96.4
4964X2DM/W33	374.9	332	428	2	53.2
40/530X3/DCYA1	437	548	760	2	365

Four-point Contact Ball Bearing

Basic Design

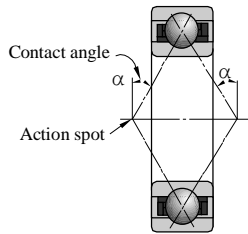

Four-point contact ball bearing, as a kind of single-row contact ball bearing, is a separable type bearing and the steel balls four-point contact with ring with the contact angle of 35° that can carry radial load and axial load from any direction or the combined load from axial and radial direction. This kind of bearing can limit both side axial displacement of shaft or housing within axial clearance range. Compared with other ball bearings, when the radial clearance is the same, the axial clearance is small, load capacity is big and limit rotation speed is high.

This kind of bearing is mainly applied to carry axial load and installed into the bearing box that is used as thrust bearings with a certain radial clearance. Besides common four-point ball bearing, there is another kind of four-point ball bearing with N2 suffix. There are two locating slot on outer ring end face, in order to locate easily and prevent outer ring rotating.

Common Information and Data Dimension

Inner diameter range: 30mm~560mm
 Outer diameter range: 72mm~780mm
 Width range: 19mm~90mm

Tolerance

ZWZ produce standard series of single-row contact ball bearing according to tolerance Po, but ZWZ can also supply the bearings meeting precision Class P6 or higher. For a single bearing with contact angle (α) of 15° and 25° used for paired mounting, the precision class meets P5. For a single bearing with contact angle (α) of 40° used for paired mounting, the precision class meets P6. ZWZ also can supply the bearings with precision 4A, 2A or other precision requirement. Please refer to standard tolerances listed in the table of preface pages.

Internal clearance

Axial clearance of four-point contact ball bearing provided by ZWZ belongs to common group radial clearance. Some types can provide bigger or smaller clearance or narrow clearance range.

Error of Centralization

For four-point contact ball bearings, ability of allowing angle error is limited, so they are not suitable for working condition of too much misalignment or shaft deflection. When it can not cause over additional stress to bearing, the angle error allowed by inner and outer ring depends on the radial clearance, bearing dimension, internal design, force and moment acted on bearing during bearing running. Due to the complicated relations among these factors, a specific common value can not be supplied.

Any angle error can lead to increase of noise, stress acting on cages and shorten bearing service life.

Cage

Four-point contact ball bearings use solid brass cage without suffix code after basic bearing number.

Minimum Load

To make bearing running well, four-point contact ball bearings are the same as all other ball bearings and roller bearings that must carry a certain minimum load, especially working at high speed and high accelerated speed or in a situation where load direction changes rapidly. In these working conditions, the inertia force of steel balls and cage and the friction inside lubricating agent will have bad influence on bearing rotating, besides, there will be harmful sliding motion to bearing formed between balls and raceways.

Minimum load needed for four-point contact ball bearing can be calculated as following formula:

$$F_m = k_m \frac{C_{or}}{1000} \left(\frac{nD_{pw}}{100000} \right)^2$$

- F_m = Minimum axial load, kN
- k_m = Minimum axial load factor
- C_{or} = Basic rating static load, kN
- N = Rotation speed, r/min
- D_{pw} = Average bearing diameter = $0.5(d+D)$, mm

Dynamic Equivalent Load

If starting in low temperature or viscosity of lubricating agent is high, the more minimum load will be needed. It is common to exceed necessary minimum load when weight of supporting bearing added external force. If it can not reach minimum load, the bearing must

apply bigger external axial load, such as using spring.

If four-point contact ball bearings are used as fixed-end bearing, and carry radials&axial load in the meantime, the dynamic equivalent load can be calculated as formula below:

$$P = Fr + 0.66Fa, \text{ When } Fa/Fr \leq 0.95 \text{ [kN]}$$

$$P = 0.6Fr + 1.07Fa, \text{ When } Fa/Fr > 0.95 \text{ [kN]}$$

Four-point contact ball bearing will only work when steel balls contact with inner ring raceway on one point or with outer ring raceway on one point. It means axial load must meet $Fa \geq 1.2Fr$.

Static Equivalent Load

For four-point contact ball bearing carrying static load $P_o = Fr + 0.58Fa$ [kN]

Four-point Contact Ball Bearing

Supplement Code

- QJ Four-point contact ball bearing with split inner bearing race
- QJF Four-point contact ball bearing with split outer bearing race
- C1 Clearance conforms to Group 1 specified in standard clearance
- C2 Clearance conforms to Group 2 specified in standard clearance
- C3 Clearance conforms to Group3 specified in standard clearance
- C4 Clearance conforms to Group3 specified in standard clearance
- C9 Clearance is different from current standard
When there are two or more than two clearance is different from current standard clearance in uniform code, use attached digits
- HA Ring, rolling element and cage or only the ring and cage is made up of vacuum smelting bearing steel
- J Pressed-sheet steel cage, attach digits to tell when material changes
- M Solid brass cage
- MA Solid brass cage, guided with outer ring
- MB Solid brass cage, guided with inner ring
- N1 Bearing outer ring with a positioning notch
- N2 Bearing outer ring with two or more than two symmetric positioning notches
- Q Solid bronze cage, indicate different materials by attached digits
- Q1- Aluminium, fe and mn bronze
- Q2- Zinc silicon bronze
- Q3- Silicon nickel bronze
- Q4- Aluminum bronze
- Q5- Stannum bronze
- P6 Tolerance grade conforms to the standard P6
- RS2 Bearing with frame system rubber seal ring (contact system), the material of seal ring is fluoride rubber
- 2RS2 Bearing with RS2 sealed on both sides
- S2 Bearing ring tempered in high temperature, which can reach 250*
- U Thrust ball bearing with spherical seat washer
- X1 Non-standard outer diameter
- X2 Non-standard width (height)
- X3 Non-standard outer diameter, width (height) (standard bore diameter)

Axial clearance of four-point contact ball bearing Table 1 (µm)

d mm		Grovp 2		Grovp 0		Grovp 3		Grovp 4	
Over	To	min	max	min	max	min	max	min	max
-	18	15	55	45	85	75	115	105	145
18	40	26	66	56	106	96	146	136	186
40	60	36	86	76	126	116	166	156	206
60	80	46	96	86	136	126	176	166	216
80	100	56	116	96	156	136	196	176	236
100	140	66	136	116	176	156	216	196	256
140	180	76	156	136	196	176	236	216	276
180	220	96	176	156	216	196	256	236	296
220	260	115	195	175	235	215	295	275	335
260	300	135	215	195	275	255	335	295	355
300	350	155	235	215	295	275	355	335	415
350	400	175	265	245	325	305	385	365	465
400	500	205	305	285	385	355	455	435	525
500	600	255	355	335	445	425	545	525	615

Four-point Contact Ball Bearing

d 30-90 mm

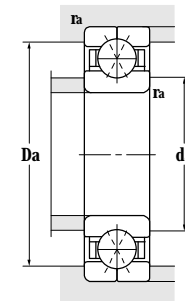
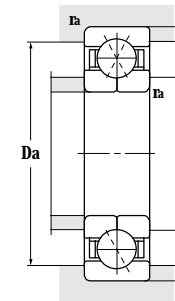
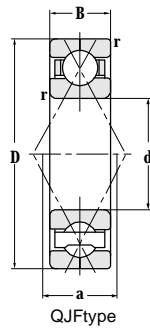
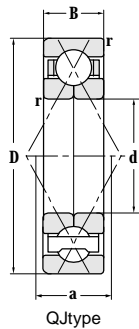

Principal dimensions				Basic load ratings		Limit speed ratings	
d	D	B	r _{min}	C _r	C _{or}	Grease	Oil
mm				kN		r/min	
30	72	19	1.1	50.1	38	8000	11000
35	80	21	1.5	57.2	45	7100	9500
40	80	18	1.1	56	46	6700	9000
	90	23	1.5	72	58	5300	8500
45	100	25	1.5	88.9	72	5600	7500
55	100	21	1.5	98	71	530	7000
60	110	22	1.5	92.3	87	4800	6300
65	140	33	2.1	158	140	3800	5300
	140	33	2.1	158	140	3800	5300
	140	33	2.1	158	140	3500	5000
70	125	24	1.5	109	109	4000	5600
	150	35	2.1	185	166	3600	5000
	150	35	2.1	185	165	3600	4800
	150	35	2.1	185	165	3600	4800
75	130	25	1.5	117	123	3800	5300
	149	31	1	148	146	4000	5300
	160	37	2.1	212	204	3400	4800
	160	37	2.1	212	204	3400	4800
80	125	22	1.1	80	91.5	3900	5200
	140	26	2	138	146	3600	5000
	140	26	2	138	146	3600	5000
85	180	41	3	248	255	3000	4000
90	160	30	2	167	178	3200	4300
	160	30	2	167	178	3200	4300
	160	30	2	138	147	3200	4300

Designations	Contact points a	Abutment and fillet dimensions			Weight kg
		d _{amin}	D _{amax}	r _{amax}	
		mm			
QJ306MA	35.7	37	65	1	0.463
QJ307N2Q1	40.3	44	71	1.5	0.69
QJ208 QJ308	42	47	73	1	0.445
	45.5	50	80	1.5	0.793
QJ309M	50.8	54	91	1.5	1.08
QJ211	54.3	64	91	1.5	0.798
QJ212M	59.5	69	101	1.5	0.928
QJ313Q1 QJ313N2Q1 QJ313M	71.8	77	128	2	2.32
	71.8	77	128	2	2.32
	71.8	77	128	2	2.34
QJ214N2Q1 QJ314M QJ314N/YAB QJ314N2/C9YAB	68.3	79	116	1.5	1.29
	78.4	82	138	2	3.28
	77	84	134	2	3.32
	77	84	134	2	3.22
QJ215M QJ215X3R/YA6 QJ315N2 QJ315N2/C9	71.8	84	121	1.5	1.38
	75.3	84	120	2	2.33
	82.3	87	148	2	3.83
	82.3	87	148	2	3.83
QJ1016N2 QJ216 QJ216N2	71.8	87	118	1	1.07
	77	90	130	2	2.02
	77	90	130	2	2.02
QJ317N2	92.8	99	166	2.5	5.45
QJ218N2 QJ218 QJ218/HAC4	87.5	100	150	2	2.87
	87.5	100	150	2	2.87
	87.5	100	150	2	2.87
	87.5	100	150	2	2.87

Four-point Contact Ball Bearing

d 90-140 mm

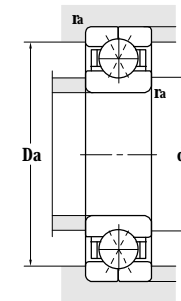
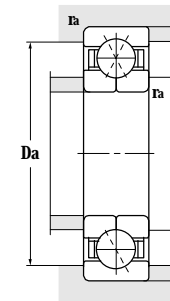
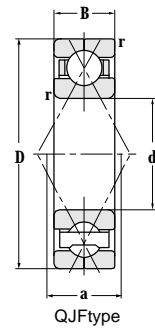
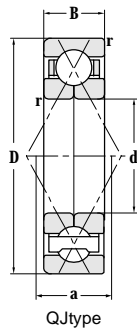

Principal dimensions				Basic load ratings		Limit speed ratings	
d	D	B	r _{min}	C _r	C _{or}	Grease	Oil
mm				kN		r/min	
90	190	43	3	254	274	2800	3800
	190	43	3	254	274	2800	3800
	190	43	3	254	274	2800	3800
95	170	32	2.1	191	204	3000	4000
	200	45	3	285	310	2600	3600
100	150	24	1.5	103	128	3200	4300
	180	34	2.1	216	230	2800	3800
	180	34	2.1	216	230	2800	3800
	215	47	3	300	370	2400	3400
105	160	26	2	120	150	2800	3800
110	170	28	2	147	186	2800	3800
	200	38	2.1	255	292	2600	3400
	200	38	2.1	255	292	2600	3400
	200	38	2.1	255	292	2600	3400
	240	50	3	365	440	2200	3000
240	50	3	345	405	2200	3000	
120	150	16	1	26.5	48	3200	4300
	215	40	2.1	275	326	2400	3200
	260	55	3	375	515	2000	2800
	260	55	3	405	515	2000	2800
	260	55	3	405	515	2000	2800
130	200	33	2	182	240	2200	3200
	230	40	3	294	370	2200	3000
	280	58	4	425	560	1900	2600
	280	58	4	425	560	1900	2600
	280	58	4	425	560	1900	2600
140	210	33	2	268	273	2200	3000
	250	42	3	315	425	2000	2800
	250	42	3	330	440	2000	2800

Designations	Contact points a	Abutment and fillet dimensions			Weight kg
		d _{amin}	D _{amax}	r _{amax}	
		mm			
QJ318N2	98	104	176	2.5	6.19
NJ318N2Q1	98	104	176	2.5	6.22
QJ318/P6	98	104	176	2.5	6.26
QJ219N2	92.8	107	158	2	3.30
QJ319N2	103.3	109	186	2.5	7.52
QJF1020	87.5	109	141	1.5	1.63
QJ220	98	112	168	2	3.81
QJ220N2Q1	98	112	168	2	3.74
QJ320N2	110.3	114	201	2.5	8.78
QJ1021M	93	116	150	2	2
QJ1022M	98.1	120	160	2	2.68
QJF222	108.5	122	188	2	5.67
QJ222	108.5	122	188	2	5.49
QJ222N2Q1	108.5	122	188	2	5.37
QJ322	122.5	124	226	2.5	12.0
QJ322N2Q1	122.5	124	226	2.5	11.7
QJ1824-2RS2/C9S2YA7	94.5	130	140	0.6	0.559
QJ224N2Q1	117.3	132	203	2	6.29
QJ324	133	134	246	2.5	15.3
QJ324/C3	133	134	246	2.5	15.3
QJ324Q1	133	134	246	2.5	14.8
QJ1026	115.5	140	190	2	4.22
QJ226N2Q1	126	144	216	2.5	7.43
QJF326	143.5	148	262	3	20.7
QJ326	143.5	148	262	3	20.1
QJ326N2	143.5	148	262	3	20.1
QJF1028	122.5	150	200	2	3.35
QJ228	136.5	154	236	2.5	9.38
QJF228	136.5	154	236	2.5	10.4

Four-point Contact Ball Bearing

d 140~190 mm

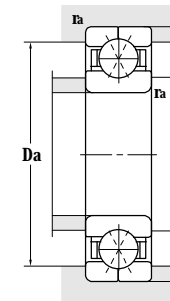
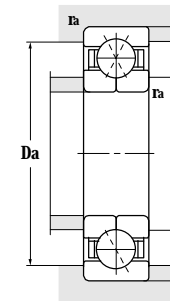
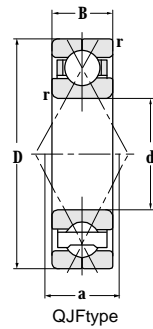
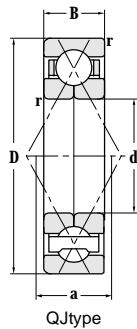

Principal dimensions				Basic load ratings		Limit speed ratings	
d	D	B	r _{min}	C _r	C _{or}	Grease	Oil
mm				kN		r/min	
140	250	42	3	315	410	2000	2800
	300	62	4	470	645	1700	2400
	300	62	4	470	645	1700	2400
150	225	35	2.1	220	298	2000	2800
	225	35	2.1	220	298	2000	2800
	225	35	2.1	176	213	2000	2800
	270	45	3	340	470	1800	2600
	270	45	3	340	470	1800	2600
	320	65	4	540	795	1600	2200
	320	65	4	540	795	1600	2200
	320	65	4	540	795	1600	2200
160	240	38	2.1	239	335	1900	2600
	290	48	3	375	545	1700	2400
	290	48	3	375	545	1700	2400
	340	68	4	540	785	1500	2000
170	259.5	42	2.1	292	410	1800	2400
	260	42	2.1	292	410	1800	2400
	260	42	2.1	292	410	1800	2400
	260	42	2.1	292	410	1800	2400
	310	52	4	460	690	1600	2200
	310	52	4	590	740	1600	2200
	360	72	4	600	970	1500	1800
180	259.5	52	2	248	370	1700	2300
	280	46	2.1	320	490	1700	2200
	280	46	2.1	320	490	1700	2200
	320	52	4	475	735	1500	2000
	320	52	4	475	735	1500	2000
	380	75	4	690	1130	1500	2000
	380	75	4	585	1120	1300	1800
	380	75	4	585	1120	1300	1800
190	280	55	2.5	299	450	1600	2200
	289.5	46	2.1	325	490	1600	2200

Designations	Contact points a	Abutment and fillet dimensions			Weight kg
		d _{amin}	D _{amax}	r _{amax}	
		mm			
QJ228N2Q1	136.5	154	236	2.5	9.36
QJ328	154	158	282	3	23.3
QJ328N2Q1	154	158	282	3	23.0
QJF1030	131.3	162	213	2	5.29
QJ1030	131.3	162	213	2	5.26
QJF1030J/C9	131.3	162	213	2	4.37
QJ230	147	164	256	2.5	12.0
QJ230N2Q1	147	164	256	2.5	12.0
QJF330	164.5	168	302	3	29.4
QJ330N2Q1	164.5	168	302	3	26.9
QJ330M	164.5	168	302	3	27.4
QJF1032	140	172	228	2	6.54
QJ232	157.5	174	276	2.5	15.4
QJ232N2Q1	157.5	174	276	2.5	14.8
QJ332N2Q1	175.1	178	322	3	34.4
QJ1034X1	150.5	182	248	2	8.13
QJ1034N2Q1	150.5	182	248	2	8.06
QJF1034	150.5	182	248	2	8.82
QJ1034	150.5	182	248	2	8.23
QJ234	168	188	292	3	18.7
QJ234N2Q1	168	188	292	3	18.2
QJ334	186	188	344	3	40.7
QJF3936X1	154	190	249	2	9.18
QJF1036	161	192	268	2	10.9
QJ1036	161	192	268	2	10.7
QJ236	175.1	198	302	3	17.7
QJF236	175.1	198	302	3	18.0
QJ336	196.1	198	362	3	46.2
QJ336N2Q1	196.1	198	362	3	46.2
176738U	164.5	203	267	2	11.6
QJF1038X1	168.1	202	278	2	11.1

Four-point Contact Ball Bearing

d 190~280 mm

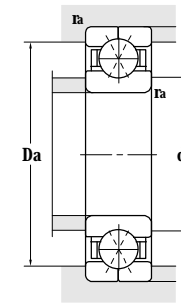
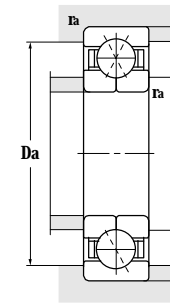
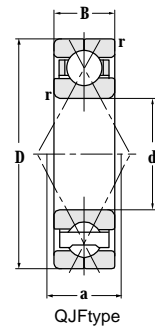
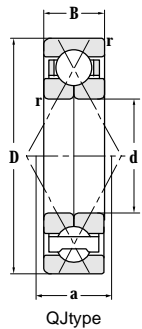

Principal dimensions				Basic load ratings		Limit speed ratings	
d	D	B	r _{min}	C _r	C _{or}	Grease	Oil
mm				kN		r/min	
190	290	46	2.1	325	490	1600	2200
	290	46	2.1	325	490	1600	2200
	340	55	4	500	800	1400	2000
	340	55	4	500	800	1400	2000
	400	78	5	680	1100	1250	1600
200	300	58	2.5	325	505	1500	2000
	310	51	2.1	390	620	1500	2000
	310	51	2.1	390	620	1500	2000
	360	58	4	510	850	1300	1800
	360	58	4	515	855	1300	1800
	420	80	5	740	1270	1200	1600
220	299.5	60	2.1	265	420	1200	1600
	300	60	2.1	265	420	1200	1600
	340	56	3	400	655	1200	1700
	400	65	4	465	1050	1100	1500
	400	78	4	465	1050	1100	1500
	460	88	5	765	1350	1000	1500
	460	88	5	760	1400	950	1400
	460	88	5	760	1400	950	1400
240	339.5	60	3	370	640	1100	1500
	340	60	3	370	640	1100	1500
	360	56	3	265	380	1100	1500
	360	56	3	430	756	1100	1500
	440	72	4	635	1100	1000	1400
	440	72	4	635	1100	1000	1400
260	360	46	2.1	387	676	1000	1400
	360	46	2.1	385	675	1000	1400
	399.5	65	4	507	910	980	1200
	400	65	4	507	910	980	1200
	480	80	5	670	1372	900	1300
	480	90	5	835	1620	900	1300
	480	90	5	835	1620	900	1300
280	375	65	2.1	370	670	960	1300
	389.5	46	2.1	430	800	960	1000

Designations	Contact points a	Abutment and fillet dimensions			Weight kg
		d _{amin}	D _{amax}	r _{amax}	
		mm			
QJF1038	168.1	202	278	2	11.1
QJ1038N2Q1	168	202	278	2	11.5
QJ238	185.6	208	322	3	24.0
QJF238	185.6	208	322	3	22.6
QJ338	207	214	379	4	50
176740U	175.1	213	287	2	14.7
QJ1040	178.6	212	298	2	14.7
QJF1040	178.6	212	298	2	14.7
QJ240	196.1	218	342	3	27.1
QJF240	196.1	218	342	3	27.3
QJ340N2	217.1	222	398	4	55.3
QJF3944	182.1	232	287	2	12.7
QJF3944X1	182.1	232	287	2	12.6
QJ1044N2Q1	196.1	234	326	2.5	17.8
QJ244N2	217.1	238	382	3	39.2
QJ1244N2	217.1	238	382	3	44.8
QJ344N2Q1	238	242	438	4	79.2
QJ344	238	424	439	4	79
QJF3948X1-1	203.1	254	326	2.5	17.7
QJF3948X1-2	203.1	254	326	2.5	16.1
QJ1048	210.1	254	346	2.5	20.9
QJ1048N2Q1	210.1	254	346	2.5	20.9
QJ248	238	256	421	3	54
QJ1952E	217.1	272	348	2	15.5
QJF1952	217	279	343	2	15
QJF1052X1	231	278	382	3	31.3
QJ1052M	231	278	382	3	31.5
QJ252	259.1	282	458	4	72.8
QJ1252	370	282	458	4	78.5
QJF2956X3-1	229.3	298	359	2	20.5
QJF1956X1	234.6	292	377		18.8

Four-point Contact Ball Bearing

d 280~560 mm

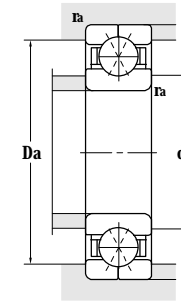
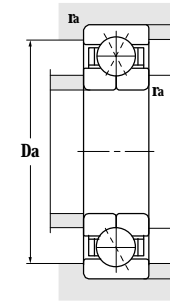
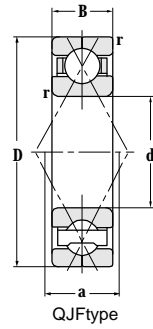
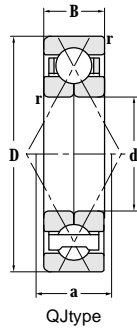

Principal dimensions				Basic load ratings		Limit speed ratings	
d	D	B	r _{min}	C _r	C _{or}	Grease	Oil
mm				kN		r/min	
280	389.5	65	2.1	430	800	960	1000
	420	65	4	533	1010	960	1000
	420	65	4	533	1010	960	1000
	500	90	5	710	1400	950	1300
300	460	74	4	605	1224	900	1100
	540	98	5	700	1480	800	1150
320	459.5	60	2.1	460	1100	850	1200
	479.5	74	4	630	1330	850	1200
	580	105	5	900	2000	850	1100
340	520	82	5	750	1635	700	950
	520	82	5	750	1635	700	950
360	540	82	5	775	1750	850	1000
	650	122	6	1080	2500	750	1000
380	560	82	5	865	1900	700	950
	680	132	6	1140	2900	650	950
400	600	90	5	880	5150	750	950
	720	140	6	1245	3125	650	850
420	560	65	4	620	1550	750	950
	620	90	5	900	2320	650	900
	620	90	5	920	2250	630	900
	760	150	7.5	1400	3700	550	750
440	600	74	4	740	1820	650	850
	650	94	6	975	2550	600	800
	790	155	7.5	1360	3700	600	700
460	680	100	6	1010	2550	650	850
	830	165	7.5	1490	4200	500	700
560	780	60	5	689	1840	600	800

Designations	Contact points a	Abutment and fillet dimensions			Weight kg
		d _{amin}	D _{amax}	r _{amax}	
		mm			
QJF2956X3	234.6	292	377		24.1
QJ1056M	245.1	262	402	3	34.4
QJF1056	245.1	262	402	3	33.5
QJ1256	390	302	478	4	83
QJF1060	266.1	318	442	3	48.2
QJ1260	420	321	518	4	106
QJF1964X3	273	344	435	2	35.7
QJF1064X1	280.1	338	462	3	52.2
QJ1264	450	341	558	4	132
QJ1068	301.1	360	500	4	68.4
QJF1068	301.1	360	500	4	68.8
QJ1072	315	381	518	4	71.5
QJ1272	505	388	621	5	188
QJ1076	329	402	538	4	74
QJ1276	530	409	651	5	225
QJ1080	350	422	579	4	95
QJ1280	560	429	691	5	259
QJ1984	343	438	541	3	50
QJ1084	364	442	598	4	100
QJF1084	364	442	598	4	101
QJ1284	590	456	725	6.5	320
QJ1988	364	460	580	3	66
QJ1088	382	468	621	5	110
QJ1288	615	477	755	6.5	352
QJ1092	399	488	652	5	130
QJ1292	645	498	795	6.5	420
QJF9/560X1	469.1	582	758	4	100

Self-aligning Ball Bearing

Product Characteristics:

Self-aligning ball bearing has two-row balls and one concave spherical raceway on outer raceway. The center of outer raceway curvature is in accordance with the bearing center, therefore this bearing is self-aligning and can also rotate even if the inner ring, balls and cage are tilting against the outer ring. This bearing can resist the misalignment of shaft with bearing box. It is mainly used for carrying radial load and small axial load, but can not carry pure axial load. This bearing is used especially for the applications with serious shaft deflection or misalignment. So this bearing is a the most widely used in machinery industries such as precision meter, low noise electric motor, automobile, motorcycle, woodworker, transmission shaft of textile machinery, mining machinery, electromechanical equipments, plastic machinery, office equipments, medical equipments, fitness equipments, excise equipments and other general machineries.

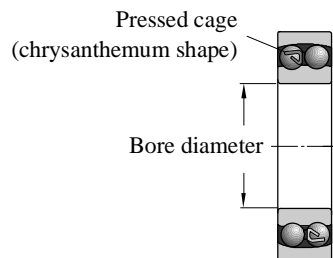

Product Type:

ZWZ manufactures two types of self-aligning ball bearings:

- Self-aligning ball bearing with cylindrical bore
- Self-aligning ball bearing with tapered bore

Self-aligning ball bearing with cylindrical bore

Realizes self-aligning automatically because of two-row steel balls and arc outer raceway. This bearing can also resist the angle error between the shaft and bearing housing, so it is suitable for the applications with shaft deflection and error shaft center due to eccentricity. Self-aligning ball bearing has the smallest internal friction among all rolling bearings, so it has small temperature raise even at high rotation speed.

Self-aligning ball bearing with tapered bore

Has the same features with self-aligning ball bearing with cylindrical bore. This bearing has a tapered bore (normal conicity 1:12) and the clearance of bearing can be adjusted slightly when mounting onto tapered shaft. This bearing is usually applied to the double-supporting shafts that bend greatly under load, as well as to the parts whose two supporting holes can not ensure strictly concentric. This bearing mainly bear radial load and slight axial load. Normally, it can not carry pure axial load. The generality of this bearing type is just the second to the deep groove ball bearing. The limited rotation speed is smaller than that of deep groove ball bearing. But the loads it can bear are higher than those of deep groove ball bearing.

Dimension Range

The basic dimensions of ZWZ self-aligning ball bearing are listed in dimension table.

- Bore diameter range : 25mm - 1100mm
- Outer diameter range: 52mm - 1300mm
- Width range: 15mm - 300mm

Tolerance

The standard tolerance of ZWZ self-aligning ball bearing is Class Normal, which conforms to GB307.1. Please refer to tolerances listed in the table of preface pages.

Radial Clearance

The standard internal clearances of ZWZ self-aligning ball bearing are C2, Normal (CN), C3, C4 and C5, which all conform to GB4604. The standard clearance of self-aligning ball bearing with tapered bore is C3. Please refer to radial clearances listed in the table of preface pages. The values are available for the bearings before mounting or without load. The bearings with internal clearance larger or lower than standard values can also be manufactured according to customers' requirements.

Cage

Self-aligning ball bearing generally use pressed cage, solid brass cage and nylon cage. The materials of cage are sheet steel, brass and synthetic resin. When bearing outer diameter is lower than 200mm, pressed steel sheet (strap) cage is adopted without suffix after basic bearing number. When outer diameter is larger than 200mm, brass solid cage is adopted without suffix after basic bearing number. The bearing with nylon cage can operate under ambient temperature of +120* or higher. The brass solid cage is considered when the bearing is used under high temperature or in critical conditions.

Please contact with ZWZ if requesting for the bearing with non-standard cage.

Dynamic Equivalent Load:

$$\text{When } Fa/Fr \leq e, \\ P = Fr + Y1Fa \\ \text{When } Fa/Fr > e, \\ P = 0.65F + Y2Fa$$

The values of e, Y1 and Y2 can be found in dimension table of bearing.

Static Equivalent Load

$$P0 = Fr + Y0Fa$$

The value of Y0 can be found in dimension table of bearing.

Self-aligning Ball Bearing

d 25-45 mm

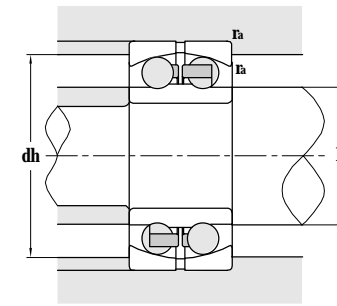
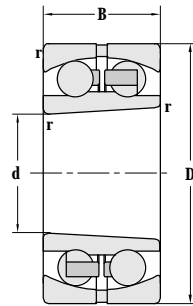
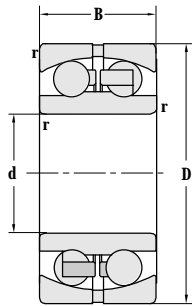

Principal dimensions				Basic load ratings		Limit speed ratings		Designations		
d	D	B	r _{min}	C _r	C _{or}	Grease	Oil	Cylindrical bore	Tapered bore	
mm				kN		r/min				
25	52	15	1	13.9	3.88	13000	16000	1205TN1		
	62	17	1.1	18.4	5.24	9500	12000	1305TN1		
30	62	16	1	15.6	4.70	10000	13000	1206	1206K	
	62	20	1	23.0	6.50	9500	12000	2206	2206K	
	62	20	1	23.0		9500	12000	2206TN1		
	72	27	1.1	31.0	8.70	8500	10000	2306	2306K	
	72	27	1.1	31.0		8500	10000	2306TN1		
35	72	17	1.1	18.4	5.82	9000	11000	1207	1207K	
	72	17	1.1	18.4	5.82	9000	11000	1207TN1	1207KTN1	
	72	23	1.1	29.8	8.54	8500	10000	2207	2207K	
	72	23	1.1	29.8	8.54	8500	10000	2207TN1		
	80	21	1.5	25.7	8.25	7500	9000	1307	1307K	
	80	21	1.5	25.7	8.25	7500	9000	1307TN1	1307KTN1	
	80	31	1.5	39.0	11.1	7000	8500	2307	2307K	
	80	31	1.5	39.0	11.1	7000	8500	2307TN1		
	40	80	18	1.1	19.3	6.74	8500	10000	1208	1208K
		80	18	1.1	19.3	6.74	8500	10000	1208TN1	1208KTN1
80		23	1.1	30.9	9.70	7500	9000	2208	2208K	
80		23	1.1	30.9	9.70	7500	9000	2208TN1	2208KTN1	
90		23	1.5	32.8	10.9	6700	8000	1308	1308K	
90		23	1.5	32.8	10.9	6700	8000	1308TN1	1308KTN1	
90		33	1.5	52.4	15.5	6300	7500	2308	2308K	
90		33	1.5	52.4	15.5	6300	7500	2308TN1	2308KTN1	
45		85	19	1.1	22.2	7.57	7500	9000	1209	1209K
		85	19	1.1	22.2	7.57	7500	9000	1209TN1	1209KTN1
	85	23	1.1	31.5	10.3	7000	8500	2209	2209K	
	85	23	1.1	31.5	10.3	7000	8500	2209TN1	2209KTN1	
	100	25	1.5	38.5	13.0	6300	7500	1309	1309K	
	100	25	1.5	38.5	13.0	6300	7500	1309TN1	1309KTN1	
	100	36	1.5	61.8	18.7	5600	6700	2309	2309K	
	100	36	1.5	61.8	18.7	5600	6700	2309M		

Abutment and fillet dimensions			Axle load coefficient				Weight	
D _{smin}	dh _{max}	r _{amax}	e	Y1	Y2	Y0	Cylindrical bore	Tapered bore
mm	mm	mm	mm				kg	
30	47	1	0.28	2.2	3.5	2.5	0.137	
31.5	55.5	1	0.28	2.2	3.5	2.5	0.249	
35	57	1	0.25	2.5	3.87	2.62	0.228	0.221
35	57	1	0.39	1.63	2.53	1.71	0.260	0.248
35	57	1	0.39	1.63	2.53	1.71	0.242	
36.5	65.5	1	0.44	1.43	2.22	1.5	0.515	0.495
36.5	65.5	1	0.44	1.43	2.22	1.5	0.494	
41.5	65.5	1	0.23	2.74	4.24	2.87	0.318	0.308
41.5	65.5	1	0.23	2.74	4.24	2.87	0.309	0.300
41.5	65.5	1	0.37	1.69	2.61	1.77	0.604	0.585
41.5	65.5	1	0.37	1.69	2.61	1.77	0.587	
43	72	1.5	0.25	2.56	3.97	2.69	0.507	0.492
43	72	1.5	0.25	2.56	3.97	2.69	0.486	0.471
43	72	1.5	0.46	1.36	2.11	1.43	0.675	0.645
43	72	1.5	0.46	1.36	2.11	1.43	0.659	
46.5	73.5	1	0.22	2.87	4.45	3.01	0.410	0.400
46.5	73.5	1	0.22	2.87	4.45	3.01	0.402	0.392
46.5	73.5	1	0.33	1.9	2.94	1.99	0.520	0.500
46.5	73.5	1	0.33	1.9	2.94	1.99	0.476	0.456
48	82	1.5	0.24	2.62	4.05	2.74	0.714	0.694
48	82	1.5	0.24	2.62	4.05	2.74	0.688	0.668
48	82	1.5	0.43	1.45	2.25	1.52	0.959	0.919
48	82	1.5	0.43	1.45	2.25	1.52	0.901	0.861
51.5	78.5	1	0.21	2.94	4.55	3.08	0.469	0.455
51.5	78.5	1	0.21	2.94	4.55	3.08	0.458	0.444
51.5	78.5	1	0.31	2.04	3.15	2.13	0.553	0.533
51.5	78.5	1	0.31	2.04	3.15	2.13	0.503	0.483
53	92	1.5	0.25	2.53	3.92	2.66	0.951	0.926
53	92	1.5	0.25	2.53	3.92	2.66	0.920	0.895
53	92	1.5	0.42	1.51	2.33	1.58	1.24	1.19
53	92	1.5	0.42	1.51	2.33	1.58	1.36	

Self-aligning Ball Bearing

d 50-70 mm

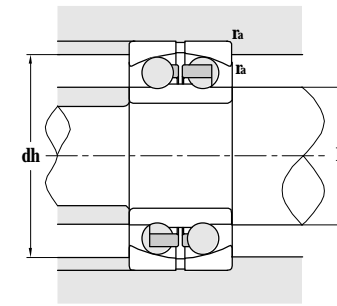
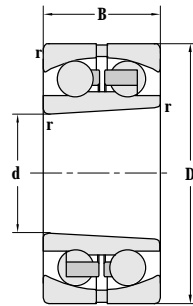
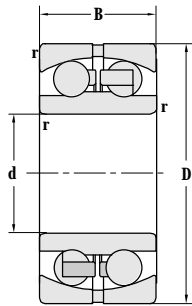

Principal dimensions				Basic load ratings		Limit speed ratings		Designations		
d	D	B	r _{min}	C _r	C _{or}	Grease	Oil	Cylindrical bore	Tapered bore	
mm				kN		r/min				
50	90	20	1.1	25.7	8.88	7000	8500	1210	1210K	
	90	20	1.1	25.7	8.88	7000	8500	1210TN1	1210KTN1	
	90	23	1.1	32.8	10.9	6300	7500	2210	2210K	
	90	23	1.1	32.8	10.9	6300	7500	2210TN1	2210KTN1	
	110	27	2	43.5	14.0	5600	6700	1310	1310K	
	110	40	2	63.5	20.0	5300	6300	2310	2310K	
55	100	21	1.5	27.0	10.6	6300	7500	1211	1211K	
	100	21	1.5	27.0	10.6	6300	7500	1211TN1	1211KTN1	
	100	25	1.5	37.8	13.0	6000	7000	2211	2211K	
	120	29	2	51.5	18.0	5000	6000	1311	1311K	
	120	29	2	51.5	18.0	5000	6000	1311TN1	1311KTN1	
	120	43	2	75.0	23.5	4300	5000	2311	2311K	
60	110	22	1.5	31.0	11.8	5600	6700	1212	1212K	
	110	22	1.5	31.0	11.8	5600	6700	1212TN1	1212KTN1	
	110	28	1.5	47.5	16.5	5300	6300	2212	2212K	
	110	28	1.5	47.5	16.5	5300	6300	2212TN1	2212KTN1	
	130	31	2.1	58.5	21.3	4500	5300	1312	1312K	
	130	31	2.1	58.5	21.3	4500	5300	1312TN1	1312KTN1	
	130	46	2.1	86.5	27.7	4500	5300	2312	2312K	
	130	46	2.1	86.5	27.7	4500	5300	2312M		
	150	35	2.1	76.5	28.4	3800	4500	1412		
	150	35	2.1	73.5	26.7	3800	4500	1412M		
	65	120	23	1.5	34.0	13.6	5300	6300	1213	1213K
		120	23	1.5	34.0	13.6	5300	6300	1213TN1	1213KTN1
120		31	1.5	55.5	19.4	5000	6000	2213	2213K	
140		33	2.1	63.0	24.7	4300	5000	1313	1313K	
140		48	2.1	95.5	32.5	4000	4800	2313	2313K	
70		125	24	1.5	34.5	14.2	5000	6000	1214	1214K
	125	31	1.5	44.0	17.0	4800	5600	2214	2214K	
	150	35	2.1	74.5	27.8	4000	4800	1314	1314K	
	150	51	2.1	109	37.5	3800	4500	2314		

Abutment and fillet dimensions			Axle load coefficient				Weight	
D _{smin}	dh _{max}	r _{amax}	e	Y1	Y2	Y0	Cylindrical bore	Tapered bore
mm			mm				kg	
56.5	83.5	1	0.2	3.13	4.85	3.28	0.547	0.527
56.5	83.5	1	0.2	3.13	4.85	3.28	0.535	0.515
56.5	83.5	1	0.29	2.2	3.41	2.31	0.618	0.598
56.5	83.5	1	0.29	2.2	3.41	2.31	0.567	0.547
59	101	2	0.24	2.68	4.14	2.8	1.21	1.18
59	101	2	0.42	1.49	2.3	1.56	1.66	1.58
63	95	1.5	0.2	3.23	4.99	3.38	0.708	0.683
63	95	1.5	0.2	3.23	4.99	3.38	0.681	0.656
63	95	1.5	0.28	2.26	3.5	2.37	0.824	0.794
64	111	2	0.23	2.7	4.18	2.83	1.57	1.53
64	111	2	0.23	2.7	118	2.83	1.51	1.47
64	111	2	0.41	1.53	2.36	1.6	2.10	2.00
68	102	1.5	0.19	3.39	5.25	3.56	0.892	0.872
68	102	1.5	0.19	3.39	5.25	3.56	0.870	0.850
68	102	1.5	0.28	2.27	3.51	2.38	1.16	1.12
68	102	1.5	0.28	2.27	3.51	2.38	1.09	1.05
71	119	2	0.23	2.8	4.33	2.93	1.98	1.93
71	119	2	0.23	2.8	4.33	2.93	1.92	1.87
71	119	2	0.4	1.56	2.41	1.63	2.61	2.41
71	119	2	0.4	1.56	2.41	1.63	2.68	
71	139	2	0.22	2.81	4.35	2.95	3.26	
71	139	2	0.22	2.81	4.35	2.95	3.31	
73	112	1.5	0.17	3.71	5.73	3.88	0.915	0.885
73	112	1.5	0.17	3.71	5.73	3.88	0.865	0.835
73	112	1.5	0.28	2.25	3.48	2.35	1.50	1.44
76	129	2	0.23	2.78	4.31	2.92	2.38	2.31
76	129	2	0.38	1.65	2.55	1.72	3.22	3.07
78	117	1.5	0.18	3.51	5.44	3.68	1.29	1.25
78	117	1.5	0.27	2.36	3.66	2.48	1.63	1.57
81	139	2	0.22	2.81	4.35	2.95	2.98	2.90
81	139	2	0.39	1.62	2.5	1.69	3.92	

Self-aligning Ball Bearing

d 75-100 mm

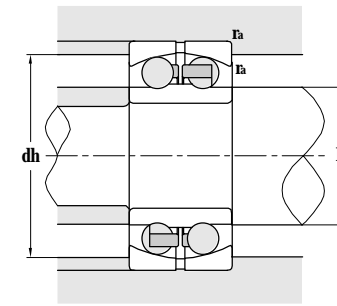
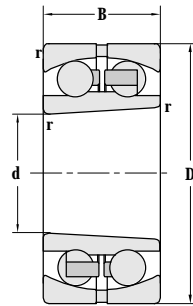
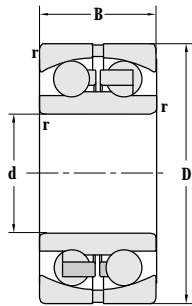

Principal dimensions				Basic load ratings		Limit speed ratings		Designations	
d	D	B	r _{min}	C _r	C _{or}	Grease	Oil	Cylindrical bore	Tapered bore
mm				kN		r/min			
75	130	25	1.5	39.0	15.5	4800	5600	1215	1215K
	130	31	1.5	55.5	21.3	4500	5300	2215	2215K
	160	37	2.1	79.5	29.9	3800	4500	1315	1315K
	160	55	2.1	123	43.0	3400	4000	2315	2315K
	160	55	2.1	123	43.0	3400	4000	2315TN1	
80	140	26	2	40.0	16.9	4500	5300	1216	1216K
	140	26	2	40.0	16.9	4500	5300	1216TN1	1216KTN1
	140	33	2	63.0	24.7	4000	4800	2216	2216K
	170	39	2.1	89.0	33.5	3600	4300	1316	1316K
	170	58	2.1	131	47.5	3200	3800	2316	2316K
	170	58	2.1	131	47.5	3200	3800	2316TN1	
	170	58	2.1	131	47.5	3200	3800	2316M	
85	150	28	2	49.0	20.5	4000	4800	1217	1217K
	150	36	2	58.5	23.6	3800	4500	2217	2217K
	180	41	3	98.5	38.0	3400	4000	1317	1317K
	180	60	3	139	51.5	3000	3600	2317	2317K
90	160	30	2	57.0	23.4	3800	4500	1218	1218K
	160	40	2	70.0	28.5	3400	4300	2218	2218k
	190	43	3	117	45.0	3200	3800	1318	1318K
	190	43	3	118	45.1	3200	3800	1318M	
	190	64	3	151	57.0	2800	3400	2318	2318k
	190	64	3	152	57.1	2800	3400	2318M	2318KM
95	170	32	2.1	64.0	27.0	3600	4300	1219	1219K
	170	43	2.1	83.5	34.0	3400	4000	2219	2219K
	200	45	3	132	51.0	3000	3600	1319	1319k
	200	67	3	164	64.5	2600	3200	2319	2319K
100	180	34	2.1	69.0	29.5	3400	4000	1220	1220K
	180	34	2.1	69.1	29.5	3400	4000	1220M	1220KM
	180	46	2.1	97.5	40.5	3200	3800	2220	2220K
	180	46	2.1	97.6	40.6	3200	3800	2220M	2220KM
	215	47	3	143	58.0	2800	3400	1320J	1320KJ

Abutment and fillet dimensions			Axle load coefficient			Weight		
D _{smin}	d _{hmax}	r _{amax}	e	Y1	Y2	Y0	Cylindrical bore	Tapered bore
mm			mm			kg		
83	122	1.5	0.17	3.6	5.58	3.77	1.35	1.31
83	122	1.5	0.25	2.49	3.86	2.61	1.71	1.64
86	149	2	0.22	2.84	4.39	2.97	3.55	3.45
86	149	2	0.38	1.66	2.56	1.73	4.71	4.51
86	149	2	0.38	1.66	2.56	1.73	4.71	4.51
89	131	2	0.16	3.94	6.1	4.13	1.65	1.60
89	131	2	0.16	3.94	6.1	4.13	1.59	1.54
89	131	2	0.25	2.49	3.86	2.61	2.19	2.11
91	159	2	0.22	2.92	4.52	3.06	4.19	4.09
91	159	2	0.39	1.63	2.53	1.71	5.70	5.50
91	159	2	0.39	1.63	2.53	1.71	5.62	5.42
91	159	2	0.39	1.63	2.53	1.71	5.93	5.73
94	141	2	0.17	3.69	5.7	3.86	2.10	2.04
94	141	2	0.25	2.48	3.84	2.6	2.53	2.43
98	167	2.5	0.22	2.9	4.49	3.04	4.95	4.81
98	167	2.5	0.38	1.67	2.59	1.75	6.73	6.43
99	151	2	0.17	3.76	5.81	3.94	2.44	2.36
99	151	2	0.27	2.36	3.65	2.47	3.22	3.08
103	177	2.5	0.22	2.81	4.35	2.94	5.99	5.82
103	177	2.5	0.22	2.81	4.35	2.94	6.70	6.40
103	177	2.5	0.38	1.67	2.58	1.74	8.27	7.97
103	177	2.5	0.38	1.67	2.58	1.74	8.45	8.15
106	159	2	0.17	3.68	5.69	3.85	3.06	2.96
106	159	2	0.26	2.38	3.69	2.5	5.38	5.20
108	187	2.5	0.23	2.77	4.29	2.9	6.98	6.80
108	187	2.5	0.38	1.68	2.59	1.76	9.20	8.80
111	169	2	0.17	3.64	5.63	3.81	3.68	3.58
111	169	2	0.17	3.64	5.63	3.81	3.78	3.68
111	169	2	0.27	2.34	3.62	2.45	4.95	4.74
111	169	2	0.27	2.34	3.62	2.45	5.15	4.95
113	202	2.5	0.24	2.67	4.13	2.8	9.14	8.94

Self-aligning Ball Bearing

d 100~1100 mm

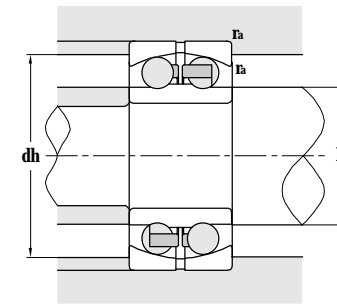
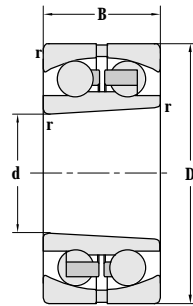
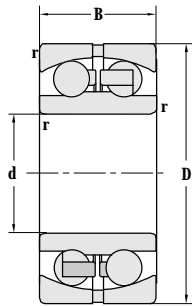

Principal dimensions				Basic load ratings		Limit speed ratings		Designations	
d	D	B	r _{min}	C _r	C _{or}	Grease	Oil	Cylindrical bore	Tapered bore
mm				kN		r/min			
100	215	73	3	191	78.5	2400	3000	2320J	2320KJ
	215	73	3	191	78.5	2400	3000	2320TN1	
105	190	36	2.1	75.0	32.0	3200	3800	1221	
	225	77	3	194	79.5	3200	2800	2321	
110	200	38	2.1	115	51.5	3000	3600	1222	1222K
	200	38	2.1	116	51.6	3000	3600	1222M	1222KM
	200	53	2.1	124	52.0	2800	3400	2222	2222K
	200	53	2.1	125	52.1	2800	3400	2222M	2222KM
	240	50	3	163.5	72.0	2400	3000	1322J	1322KJ
	240	80	3	215.5	94.0	2200	2800	2322J	2322KJ
	240	80	3	215.5	94.0	2200	2800	2322TN1	
120	215	42	2.1	119.5	52.5	2000	2600	1224	1224K
	215	42	2.1	115	50.0	2000	2600	1224J	1224KJ
130	230	46	3	125	56.5	3600	5600	1226	
140	250	50	3	155	72.0	1900	2500	1228	1228K
	250	50	3	155	72.0	1900	2500	1228-NTW	
150	235	36	3	104	53.0	2000	2600	1730	
500	720	300	6	338	301	350	400	150/500D1L	
680	900	300	6	360	370	300	350	150/680D1L	
1100	1300	300	6	328	440	130	160	150/1100D1L	

Abutment and fillet dimensions			Axle load coefficient				Weight	
D _{smin}	d _{hmax}	r _{amax}	e	Y1	Y2	Y0	Cylindrical bore	Tapered bore
mm			mm				kg	
113	202	2.5	0.37	1.69	2.62	1.77	12.4	11.8
113	202	2.5	0.37	1.69	2.62	1.77	12.1	
116	179	2	0.18	3.55	5.5	3.72	4.71	
118	212	2.5	0.39	1.64	2.53	1.71	14.4	
121	189	2	0.17	3.64	5.64	3.82	5.20	5.04
121	189	2	0.17	3.64	5.64	3.82	5.56	5.40
121	189	2	0.28	2.25	3.49	2.36	7.16	6.86
121	189	2	0.28	2.25	3.49	2.36	7.36	7.06
123	227	2.5	0.22	2.83	4.39	2.97	11.9	11.7
123	227	2.5	0.38	1.67	2.59	1.75	17.6	16.9
123	227	2.5	0.38	1.67	2.59	1.75	15.9	
131	204	2	0.2	3.21	4.97	3.36	7.04	6.84
131	204	2	0.2	3.21	4.97	3.36	7.04	6.84
144	216	2.5	0.2	3.3	5.1	3.6	8.64	
153	237	2	0.2	3.12	4.83	3.27	11.3	11.0
153	237	2	0.2	3.12	4.83	3.27	10.7	
163	222	2	0.15	4.18	6.46	4.38	6.25	
523	697	5.5	0.32	1.98	3.06	2.07	342	
703	877	5.5	0.26	2.38	3.69	2.5	447	
1123	1277	5.5	0.21	2.99	4.62	3.13	614	

Cylindrical Roller Bearing

Product Characteristics:

The cylindrical rollers have linear contact with raceways and the bearings can carry heavy radial load. They can be applied to the situation not only with heavy load and shock load but also with high rotation speed.

Cylindrical roller bearings have bigger carrying load capacity after ameliorating the geometry of the raceways and rolling elements. The new design of ribs and roller end surfaces improve lubricating conditions of contact area between roller end surface and ribs, meanwhile improve bearings service performance.

These bearings are mainly used in medium and large sized motors, electricity generators, internal combustion engines, gas turbines, machine tool spindles, deceleration devices, unloading and lifting machines and other industrial machineries.

Types of bearing:

ZWZ cylindrical roller bearings can be divided into the following types:

- Sing -row cylindrical roller bearings
- Double -row cylindrical roller bearings
- Four -row cylindrical roller bearings
- Sendzimir bearing
- Cylindrical roller bearing for pulley
- Split cylindrical bearing

Single-row Cylindrical Roller Bearing N Type

N type cylindrical roller bearings have double ribs on inner ring, without rib on outer ring and inner ring, rollers and cage can be separated from



outer ring. This type of bearings permits the shaft to move relatively to housing in axial direction. They can adapt to the position changes between the shaft and housing caused by the thermal expansion or the mounting error and are most suitable for free end shafts. They can only carry radial load and can not limit the axial displacement of shaft and housing.

NU Type

NU type cylindrical roller bearing have double ribs on outer ring, without rib on inner ring and outer ring, rollers and cage can be separated from inner ring. This type of bearings permit shaft to move relatively to housing in axial direction. They can adapt to the position changes between the shaft and housing caused by the thermal expansion or the mounting error and most suitable for free end shafts. They can only carry radial load and can not limit the axial displacement of shaft and housing.

NJ Type

NJ type cylindrical roller bearings have double ribs on outer ring, and single rib on inner ring. They can make axial location in one direction and carry a certain axial loads in single direction.

NF Type

NF type cylindrical roller bearings have double ribs on inner ring, and single rib on outer ring. They can make axial location in one direction and carry a certain axial loads in single direction.

NUP Type

NUP type cylindrical roller bearings have double ribs on outer ring, single rib and flat end ring on inner ring.

Besides radial load, this type of bearings can

carry small axial load in two directions if the displacement of shaft and housing are limited within the bearing axial clearance. Thus they can be used on the fixed end of the shaft.

NH Type

NH type cylindrical roller bearings have double ribs on outer ring, single rib and slope end ring on inner ring. Their inner rings and outer rings can be mounted separately (constituting of rollers and cage). Besides radial load, this type of bearings can carry small axial load in two directions if the displacement of shaft and housing are limited within the bearing axial clearance. Thus they can be used on the fixed end of the shaft.

NB Type

NB type bearings do not have ribs on inner or outer rings. There are lubricating holes on the outer ring. Their inner ring, outer ring and cage with rollers can be mounted separately. They can not limit the axial displacement of the shaft or housing and can not carry radial load.

NCL...V Type

NCL...V type cylindrical roller bearings do not have ribs and cage, but they have double locking rings on the outer rings.

This kind of the bearings without cage have many rollers. This type bearing can carry heavier radial load with lower limit rotation speed in comparing with other cylindrical roller bearings with the same dimensions. Their outer ring and inner ring are not separable, can not be mounted separately, but they can limit the axial displacement of the shaft and housing in two directions within bearing's axial clearance.

NJ...V Type

NJ...V type cylindrical roller bearings have single ribs on inner ring and without cage.

Because of owning large number of rollers and without cage, this type bearing can carry heavier radial load with lower limit rotation speed in comparing with others cylindrical roller bearings with the same dimensions. They cannot limit the axial displacement of the shaft or housing within bearing's axial clearance and unable to carry axial load.

NCF...V Type

NCF...V type cylindrical roller bearings belong to spherical short cylindrical roller bearings without cage and have single rib on the outer ring.

This type bearing do not have cage and full of rollers, so they can carry heavier radial load with lower limit rotating speed in comparing with others cylindrical roller bearings with the same dimensions. They can limit the axial displacement of the shaft or housing in two directions within bearing's axial clearance.

Double-row Cylindrical Roller Bearings

NN Type

NN type cylindrical roller bearings have ribs only on inner ring. The outer ring and inner ring can be mounted separately. They can not limit the axial displacements of the shaft or outer housing and can carry heavier radial load compared with other cylindrical roller bearings with the same dimensions.



Cylindrical Roller Bearing

These bearings are specially suitable for supporting machine tool shafts due to compact structure and smaller deformation caused by load.

NN...K Type

The structure of NN...K type cylindrical roller bearings is the same as the NN type. The difference is that their inner bore is tapered, which makes it easy to adjust the radial clearance and convenient to mount.

The machine tool shafts mainly adopt this type of bearings and install them on the tapered shaft. Adjust radial clearance by inner ring pressing.

NNU、NNU...K Type

NNU, NNU*K type cylindrical roller bearings have ribs only on the outer rings. According to the shape of bores, they can be divided into cylindrical and tapered bores. They do not limit the axial displacement of the shaft and outer cover, and can not carry axial load but they can carry heavier radial load compared with other cylindrical roller bearings with the same dimensions.

NNCF Type

NNCF type cylindrical roller bearings have three ribs on the inner ring and one rib on the outer ring. They can be axial located in one direction. One fixed ring equipped on the opposite of outer ring makes the bearings become one piece.

NNCL Type

NNCL type cylindrical roller bearings have three ribs only on inner rings and have stop slots on the two sides of outer rings which make the bearing become inseparable.

NNCS Type

NNCS types cylindrical roller bearings are inseparable with three ribs only on inner ring and one central locked ring on the Middle of outer ring, They do not limit the axial displacement of the shaft and bearing base and can be mounted on the free end of shafts.

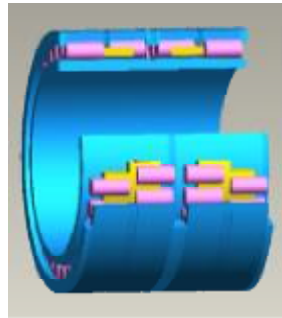

Four-row Cylindrical Roller Bearings

Four-row cylindrical roller bearings can carry heavy radial load and shock load with high manufacturing precision and are suitable for application where the rotation speed is high.

It can improve rolling accuracy by simultaneous rubbing the inner raceway surface and mill rollers after pressing inner ring into roller neck. The assembly clearances can be adjusted freely. These bearings are mostly used on working roller or support rollers of cold ,hot rolling mills and banked rolling mills, also can be used on other applications,.

FC: two ribs on outer ring, single inner ring without ribs on inner ring.

FCD: double outer rings, double inner rings, no ribs on inner ring.

FCDP: double outer rings only with central ribs and flat ring, double inner rings without ribs.

Sendzimir Bearing

Structure Characteristics

Outer ring: The bearing outer ring contacts with intermediate roll directly, endure rolling component force when rotating. According to the feature that regard bearing outer ring directly as rolling contact surface, increase thickness of outer ring and adopt special structure as the shape of generating line of bearing outer ring, eliminate the edge stress and prolong interval time for grinding outer surface, with good anti-wear and operability of regrinding, and still have high rotation speed precision after regrinding.

Inner ring: Make a special lubrication hole and oil path on the inner ring and space ring, to make lubricating oil enter into the bearing smoothly and make sure of enough rolling fatigue life.

Rolling element: According to characteristics of bearing working condition, applying finite element software to make virtual force analysis for bearing to make sure of the structure size and generating line shape of rolling element, so that rolling element can carry big radial load.

Cage: Cage is made up of material with good toughness. The design adopts special structure, reduce mutual interference when rolling elements are rotating to meet requirement of high speed.

Core of Sendzimir bearing is soft enough with good impact resistance; Surface hardening layer is deep enough, increase repair times of outer diameter when rigidity is guaranteed; Superior material organization guarantees high fatigue resistance. The grading tolerance of all the mounting wall thickness used on one shaft is $\leq 0.005\text{mm}$, grading tolerance of adjacent mounting wall thickness of bearing is $\leq 0.002\text{mm}$.

Track Roller Bearing

Structure Characteristics

Track roller bearing is the bearing that wall of outer ring is thick, with oil groove and oil hole, retainer ring and sealing structure on both sides and full complement cylindrical bearing without cage. Cylindrical surface of outer diameter have two types including cylindrical type and circular arc type. They can add single side or doubling flange to coordinate with raceway according to customers' requirement, and can also roll directly on raceway as well as carry big load and impact load. This type of bearing mainly uses sealing structure, filling lubricating grease inside to make efficient lubrication.

NUTR

Inner ring does not have ribs, with retainer ring on both sides, tightened by spring ring;

NNTR

Inner ring does not have ribs, full complement double-row roller bearing;

NUPTR

Inner ring has single rib, with retainer ring on the other side, tightened by spring ring;

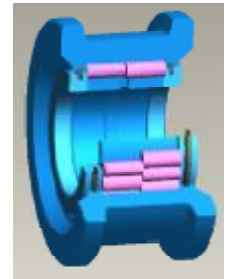

Split Cylindrical Roller Bearing

Structure Characteristics

It is a cylindrical roller bearing whose inner ring, outer ring and cage of bearing are split along a certain angle in radial direction and

Cylindrical Roller Bearing

it is fixed tightened with a grip ring on outside of inner ring. It is designed and manufactured through special technical process on basis of the whole bearing. It has low working resistance, stable operation and working temperature can reach 180*, so it is very suitable to use in the situation with low rotation speed, big load, large impact and poor sealing property. Split bearings can be mounted and dismounted easily, which can save time and reduce production cost.

Split bearings are applied in the industry field, mainly used in converter supporting, all kinds of large transport equipments, continuous casting roller supporting, elevator, conveyor and paper machinery that are hard to dismount.

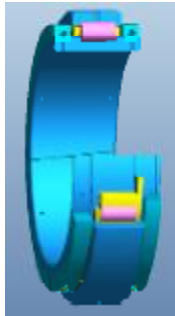

N6...D
Split cylindrical roller bearing (single row)

ND6...D
Split cylindrical roller bearing (double rows)

Dimension Range of Cylindrical Roller Bearing

ZWZ cylindrical roller bearings boundary dimensions are listed in the dimension table.

- Bore diameter range: 25mm - 1900mm
- Outer diameter range: 52mm -2300mm
- Width range: 13mm - 400mm

Tolerance:

ZWZ manufacture single-row, double-row and four-row cylindrical roller bearings with P0, P1, P2, P3 and P4 precision grade. Also ZWZ can manufacture double-row cylindrical roller bearing with SP, UP precision grade .The standard tolerances are listed in the in the preface tables.

Radial Clearance:

ZWZ manufacture single -row cylindrical roller bearings with basic group radial clearances, as well as with C3, C4 clearances, please refer to Table 14.

ZWZ manufactures double-row cylindrical roller bearings with C1 group clearances. ZWZ manufactures double-row cylindrical bore cylindrical roller bearings with C2, C3 group clearance. and also manufactures tapered bore cylindrical roller bearings with C2 group clearance .

ZWZ manufactures four-row cylindrical roller bearings with C3 group clearance and others clearance group.

The standard clearance values are listed in the preface tables.

ZWZ also manufacture the bearings with smaller or bigger radial clearance than normal one according to customer demands.

Cage:

Normally, single-row cylindrical roller bearings use turned solid cages, pressed steel cages and Nylon cages,etc.

Double-row cylindrical roller bearings mostly use turned brass cages ,sometimes use nylon cages .

Four-row cylindrical roller bearings mostly use turned brass solid cages. For big sized bearings, it is suitable to use turned solid cages.

The code name of cages are denoted as followed:

- 1.The pressed steel cages are denoted with the suffix J, different structures are denoted with the suffix J,J1 J2. . . .
- 2.Slot type cages are denoted with the suffix CJ;
- 3.Brass solid cages are denoted with the suffix M;
- 4.When the bearings OD>400mm, it use steel solid cage whose code name is not denoted. If guided by inner or outer rings, the material of cage and guide method should be denoted(A means outer ring guide, B means inner ring guide).

5.The solid brass cage for-double row cylindrical roller bearings is not denoted in code name.

Supplement Code

- /C9T Clearances of double-row raceway of double-row cylindrical roller bearing are different
- D Split bearing
- DR Double-row split bearing used in pairs
- E Internal design changes, reinforced structure. (raceway dimension conforms to current national standard (reinforced type), diameter of roller and the length increase compared with non-reinforced type)
- FC...ZW Four-row cylindrical roller bearing, single ring, double ribs on both outer rings, two rows of rollers lean on each other
 - J Pressed sheet-steel cage, attach digits when material changes
 - JA Pressed sheet-steel cage, guided with outer ring
 - JE Hard pressed sheet-steel with quenching after parkerizing
 - K Bearing with tapered hole, taper 1:12
 - K30 Bearing with tapered hole, taper 1:30
 - L Light alloy solid cage, expressed with attached digits when material of cage changes
 - LA Light alloy solid cage, guided with outer ring
 - LB Light alloy solid cage, guided with inner ring
 - M Brass solid cage
 - MA Brass solid cage, guided with outer ring
 - MB Brass solid cage, guided with inner ring
 - N Bearing with snap ring groove on outer ring
 - NB Bearing with narrow inner ring
 - NB1 Bearing with narrow inner ring, one side is narrow
 - NC Bearing with narrow outer ring
 - NR Bearing with snap ring groove and locating snap ring on outer ring of bearing
 - N1 Bearing with a locating slot on outer ring of bearing
 - N2 Bearing with a symmetrical locating slot on outer ring of bearing
 - Q Bronze solid cage, attached digits show different material
 - /QR Four cylindrical roller bearing combination, radial load is equally distributed
 - R Bearing with flanged outer ring (flanged outer ring)
 - RS Bearing with rubber seal with spring rim on one side
 - 2RS Bearing with RS seal on both sides
 - RSZ Bearing with rubber seal with spring rim on one side(contacting type), seal cover on another side
 - RZ One side of the bearing with frame-rubber sealing ring (none contact structure)
 - 2RZ Bearing with RZ seal on both sides
 - S Marquenching
 - VB Bearing with vibration screen
 - WB Bearing with wide inner ring (both sides are wide)
 - WB1 Bearing with wide inner ring (one side is wide)
 - WC Bearing with side outer ring
 - X Complement cylindrical roller bearing with flat retainer ring roller
 - X1 Outer diameter is nonstandard
 - X2 Width (height) is nonstandard
 - X3 Outer diameter and width (height) are nonstandard (standard inner diameter)
 - Z Bearing with dust cover on one side
 - 2Z Bearing with dust cover on both sides

Single-row Cylindrical Roller Bearing

d 35-40 mm

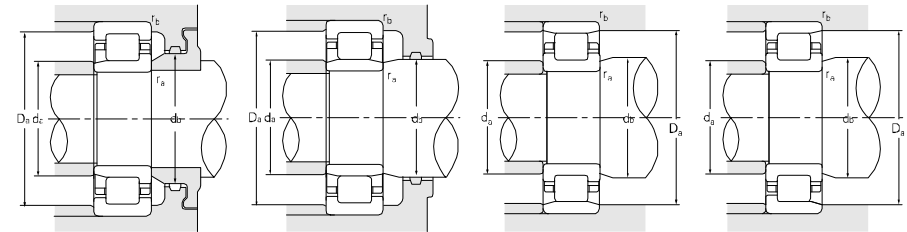
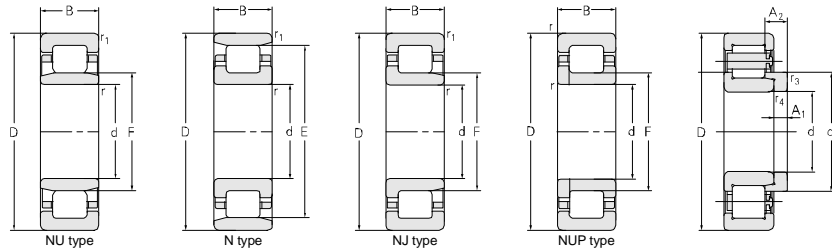

Principal dimensions						Basic load ratings		Limit speed ratings		Designations	
d	D	B	r _{1smin}	r _{smin}	F	E	C _r	C _{0r}	Grease		Oil
mm						kN		r/min			
35	72	17	0.6	1.1		64	54	46	8500	10000	N207EM
	72	17	1.1	0.6	44		54	46	8500	10000	NJ207EM
	72	17	1.1	0.6	44		54	46	8500	10000	NJ207ETN1
	72	17	1.1	0.6	44		54	46	8500	10000	NU207EM
	72	23	1.1	1.1	44		66.0	70	8500	10000	NJ2207EM
	72	23	1.1	1.1	44		66.0	70	8500	10000	NU2207EM
	72	23	1	0.6	44		66.0	70	8500	10000	NJ2207ETN1
	72	23	1	0.6	44		66	70	8500	10000	NJ2207EM/C9YA8
	72	23	1	0.6	44		66.0	70	8500	10000	NU2207ETN1/C9
	80	21	1.5	1.5		67.8	72	60	8000	9500	NCL307E/YA
	80	21	1.5	1.1	46.2		72	60	8000	9500	NJ307M
	80	21	1.5	1.5		70.2	72	60	8000	9500	N307M
	80	21	1.5	1.1	46.2		72	60	8000	9500	NJ307E
	80	21	1.5	1.1		70.2	72	60	8000	9500	NF307M
	80	21	1.5	1.1		70.2	72	60	8000	9500	NF307ETN1
	80	21	1.5	1.1	46.2		72	60	8000	9500	NU307M
	80	21	1.5	1.1	46.2		72	60	8000	9500	NU307ENRM
	80	21	1.5	1.1	46.2		72	60	8000	9500	NJ307ENRM
	80	21	1.5	1.1	46.2		72	60	8000	9500	NU307ETN1/C9
	80	21	1.5	1.5		70.2	72	60	8000	9500	NF307ETN1-FST
80	21	1.5	1.1	46.2		72	60	8000	9500	NU307EMA	
80	21	1.5	1.1	46.2		72	60	8000	9500	NU307E	
80	21	1.5	1.1	46.2		72	60	8000	9500	NU307EQ1	
80	31	1.5	1.5	46.2		87	75	7000	8500	NJ2307M	
80	31	1.5	1.5	46.2		102	94	7000	8500	NJ2307EM	
80	31	1.1	1.1	46.2		102	94	7000	8500	NU2307EM	
100	25	1.5	1.5	53		74	67	6700	8000	NJ407M	
38	83	25.4		1.1	48.5		73.5	74.5	7500	9000	NUP6/38X2NM
40	68	15	1	0.6	47		27	32	9500	12000	NU1008M
	68	15	1	0.6	47		27	32	9500	12000	NU1008TN1
	80	18	1.1	1.1	49.5		60	55.5	7500	9000	NJ208EM
	80	18	1.1	1.1	49.5		60	55.5	7500	9000	NJ208E
	80	18	1.1	1.1	49.5		60	55.5	7500	9000	NU208EM
	80	18	1.1	1.1	49.5		60	55.5	7500	9000	NUP208EM

Abutment and fillet dimensions							Weight	Model	Weight	Separate thrust collar		
d _{amin}	d _{amax}	d _{bmin}	D _{amax}	D _{amin}	r _{amax}	r _{bmax}				A1	A2	r _{3,4}
mm							kg	kg	mm			
41.5	62		68	66	1	0.6	0.331					
39	42	50	65.5		1	0.6	0.338					
39	42	50	65.5		1	0.6	0.303					
39	42	46	65.5		1	0.6	0.331					
39	42	50	65.5		1	0.6	0.363					
39	42	46	65.5		1	0.6	0.445					
39	42	50	65.5		1	0.6	0.404					
39	42	50	65.5		1	0.6	0.455					
39	42	50	65.5		1	0.6	0.393					
41.5	44	48	72		1.5	1	0.503					
41.5	44	53	72		1.5	1	0.604					
41.5	44		73.5	72	1.5	1	0.595					
41.5	44	53	72		1.5	1	0.62					
41.5	67		73.5	72	1.5	1	0.610					
41.5	67		73.5	72	1.5	1	0.519					
41.5	44	48	72		1.5	1	0.591					
41.5	44	48	72		1.5	1	0.607					
41.5	44	53	72		1.5	1	0.620					
41.5	44	48	72		1.5	1	0.500					
41.5	67		73.5	72	1.5	1.5	0.519					
41.5	44	48	72		1.5	1	0.547					
41.5	44	48	72		1.5	1	0.526					
41.5	44	48	72		1.5	1	0.591					
41.5	44	53	72		1.5	1	0.833					
41.5	44	53	72		1.5	1	0.823					
41.5	44	48	72		1.5	1	0.81					
44	49	59	85		1.5	1.5	1.10					
44.5	47	55	75		1	1	0.705					
42	45	50	65		1	0.6	0.231					
42	45	50	65		1	0.6	0.183					
46.5	48	56	73.5		1	1	0.460					
46.5		56	73.5		1	1	0.442					
46.5	48	51	73.5		1	1	0.439					
46.5		56	73.5		1	1	0.460					

Single-row Cylindrical Roller Bearing

d 40-45 mm

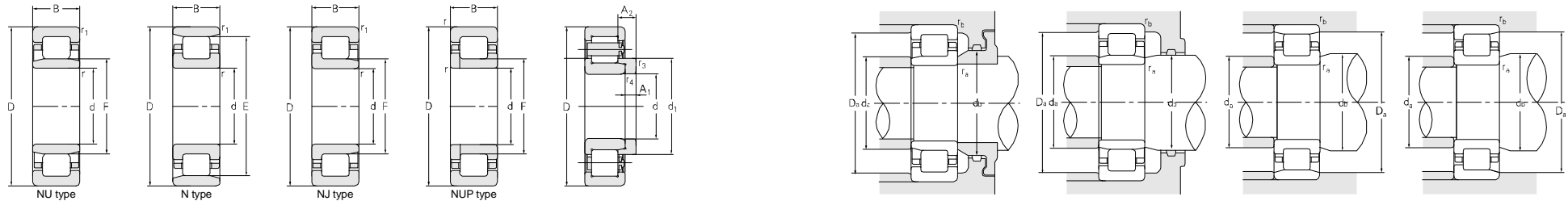

Principal dimensions						Basic load ratings		Limit speed ratings		Designations	
d	D	B	r _{1smin}	r _{smin}	F	E	C _r	C _{0r}	Grease		Oil
mm						kN		r/min			
40	80	18		1.1	49.5		60	55.5	7500	9000	NUP208ETN1
	80	18	1.1	1.1		71.5	60	55.5	7500	9000	N208EM
	80	18	1.1	1.1		71.5	60	55.5	7500	9000	NJ208ETN1
	80	18	1.1	1.1	49.5		60	55.5	7500	9000	NU208ETN1/C9
	80	18	1.1	1.1	49.5		60	55.5	7500	9000	NU208ETN1
	80	23	1.1	1.1	49.5		78	72	7500	9000	NJ2208EM
	80	23	1.1	1.1	49.5		78	72	7500	9000	NU2208EM
	80	23	1.1	1.1	49.5		78	72	7500	9000	NU2208ETN1
	80	23	1.1	1.1	49.5		78	72	7500	9000	NU2208ETN1/C9
	90	23	1.1	0.2	52.5		90	75	6700	8000	NCL308E/C9YA-1
	90	23	1.1	0.2		80	90	75	6700	8000	N308ETN1
	90	23	1.5	1.5		80	90	75	6700	8000	NF308ETN1/C9-FST
	90	23	1.5	1.5		77.5	90	75	6700	8000	NCL308E/YA
	90	23	1.5	1.5		80	90	75	6700	8000	N308EM
	90	23	1.5	1.5		80	90	75	6700	8000	NF308E
	90	23	1.5	1.5	52		90	75	6700	8000	NF308EM/C9-FST
	90	23	1.5	1.5	52		90	75	6700	8000	NJ308EM
	90	23	1.5	1.5	52		90	75	6700	8000	NJ308EM/YA8
	90	23	1.5	1.5	52		90	75	6700	8000	NJ308ETN1
	90	23		1.5	52		90	75	6700	8000	NUP308EM/C2
90	23		1.5	52		90	75	6700	8000	NUP308EM/YA6	
90	23		1.5	52		90	75	6700	8000	NUP308ETN1/YA6	
90	33	1.5	1.5	52		124	115	6300	7500	NU2308EM	
90	33	1.5	1.5	52		124	115	6300	7500	NJ2308E	
45	80.036	16	1	1	57.5		35.5	46.5	6700	8000	NJ609M/YA1
	85	19	1.1	1.1	55		57.5	56	6700	8000	NJ209M
	85	19	1.1	1.1	55		57.5	56	6700	8000	NJ209TN1
	85	19	1.1	1.1	54.5		67.5	61.5	6700	8000	NJ209EM
	85	19	1.1	1.1	55		67.5	61.5	6700	8000	NU209EM
	85	19	1.1	1.1		76.5	67.5	61.5	6700	8000	NF209EM
	85	19	1.1	1.1		76.5	67.5	61.5	6700	8000	NF209ETN1
	85	19	1.1	1.1	54.5		67.5	61.5	6700	8000	NUP209EM
	85	23	1.1	1.1	54.5		82	78	5600	6700	NU2209EM
	85	23	1.1	1.1	54.5		82	78	5600	6700	NU2209ETN1
	85	23	1.1	1.1	54.5		82	78	5600	6700	NU2209ETN1/C9

Abutment and fillet dimensions							Weight	Model	Weight	Separate thrust collar		
d _{amin}	d _{amax}	d _{bmin}	D _{amax}	D _{amin}	r _{amax}	r _{bmax}				A1	A2	r _{3,4}
mm							kg	kg	mm			
46.5	48	56	73.5		1	1	0.40					
46.5	69		73.5	73	1	1	0.425					
46.5	69		73.5	73	1	1	0.398					
46.5	48	51	73.5		1	1	0.377					
46.5	48	51	73.5		1	1	0.377					
46.5	48	56	73.5		1	1	0.539					
46.5	48	51	73.5		1	1	0.530					
46.5	48	51	73.5		1	1	0.487					
46.5	48	51	73.5		1	1	0.487					
48	50	60	82		1		0.678					
48	78		82	82	1		0.648					
48		60	82		1.5	1.5	0.667					
48	50	60	82		1.5	1.5	0.683					
48	78		82	82	1.5	1.5	0.794					
48			82	82	1.5	1.5	0.750					
48		60	82		1.5	1.5	0.813					
48	50	60	82		1.5	1.5	0.815					
48	50	60	82		1.5	1.5	0.805					
48	50	60	82		1.5	1.5	0.669					
48		60	82		1.5	1.5	0.819					
48		60	82		1.5	1.5	0.819					
48		60	82		1.5	1.5	0.673					
48	49	55	82		1.5	1.5	1.01					
48	49	60	82		1.5	1.5	1.10					
51.5	53	61	73.5	73	1	1	0.363					
51.5	53	61	78.5		1	1	0.487					
51.5	53	61	78.5		1	1	0.439					
51.5	53	61	78.5		1	1	0.51					
51.5	53	61	78.5		1	1	0.498					
51.5	73		78.5	78	1	1	0.510					
51.5	73		78.5	78	1	1	0.444					
52		61	78		1		0.507					
51	53	58	79		1	1	0.635					
51	53	58	79		1	1	0.571					
51	53	58	79		1	1	0.571					

Single-row Cylindrical Roller Bearing

d 45-50 mm

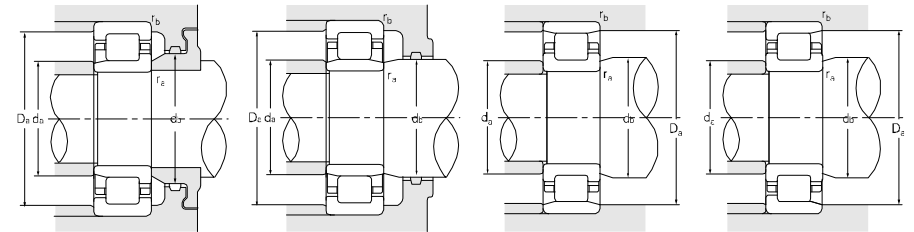
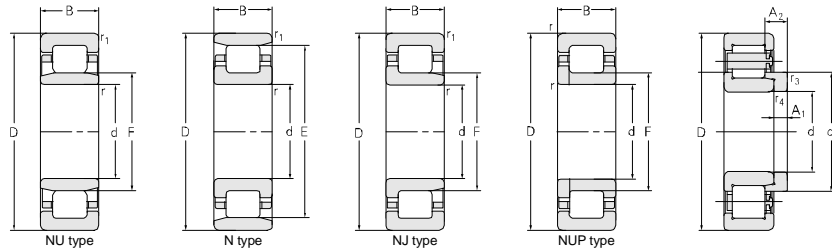

Principal dimensions						Basic load ratings		Limit speed ratings		Designations	
d	D	B	r _{1smin}	r _{smin}	F	E	C _r	C _{0r}	Grease		Oil
mm						kN		r/min			
45	85	23	1.1	1.1	54.5		82	78	5600	6700	NJ2209E/C3
	85	23	1.1	1.1	54.5		82	78	5600	6700	NJ2209EM
	85	30.16	1.1	1.1	55.52		94.6	119	6300	7500	NU3209X2M/C9YA6
	85	30.16	1.1	1.1	55.52		94.6	119	6300	7500	NU5209XPC3
	100	25	1.5	1.5		86.5	108	96	6300	7500	N309M
	100	25	1.5	1.5		86.5	108	96	6300	7500	N309J
	100	25	1.5	1.5		88.5	108	96	6300	7500	NCL309EN/YA
	100	25	1.5	1.5	58.5		108	96	6300	7500	NJ309ETN1
	100	25	1.5	1.5		88.5	108	96	6300	7500	NCL309E/YA
	100	25	1.5	1.5	58.5		108	96	6300	7500	NU309M/C3
	100	25	1.5	1.5	58.5		108	96	6300	7500	NJ309EM
	100	25	1.5	1.5		88.5	108	96	6300	7500	N309EM
	100	25	1.5	1.5	58.5		108	96	6300	7500	NUP309E
	100	25	1.5	1.5		88.5	108	96	6300	7500	N309E
	100	25	1.5	1.5		88.5	108	96	6300	7500	N309ETN1
	100	25	1.5	1.5		88.5	108	96	6300	7500	NF309E
	100	25	1.5	1.5	58.5		108	96	6300	7500	NJ309E
	100	25	1.5	1.5	58.5		108	96	6300	7500	NJ309EM/C4W124YA8
	100	25	1.5	1.5	58.5		108	96	6300	7500	NU309E
	100	25	1.5	1.5	56.4		108	96	6300	7500	NU309NRB1/YA6
	100	25	1.5	1.5	58.5		108	96	6300	7500	NUP309ETN1/HAC3YA6
	100	27.5	1.5	0.8	58.5		101	102	6300	7500	NUP309EWB1NRTN1
	100	31	1.5	1.5		88	119	120	6300	7500	NF2309X2J/YA6
	100	36	1.5	4.5	58.5		154	150	5600	6700	NU2309EM/C3
	100	36	1.5	1.5	58.5		154	150	5600	6700	NJ2309E
	100	31	1.5	1.5	58.5		141	153	5600	6700	NJ2309X2NV/C9YA26
	100	36	1.5	1.5	58.5		154	150	5600	6700	NJ2309EM
	100	36	1.5	1.5	58.5		154	150	5600	6700	NJ2309EM/C4W124
	100	36	1.5	1.5	58.5		154	150	5600	6700	NU2309E
	100.038	25	1.5	1.5		86.5	108	96	6300	7500	NF309X1MR/YA1
	120	29	2	2		100.5	124	123	5600	6700	N409M
	120	29	2	2	64.5		124	123	5600	6700	NU409M
	120	29	2	2	64.5		124	123	5600	6700	NJ409M
50	80	16	1	0.6	57.5		45	54	8500	10000	NJ1010M
	80	16	1	0.6	57.5		45	54	8500	10000	NJ1010TN1

Abutment and fillet dimensions						Weight	Model	Weight	Separate thrust collar		
d _{amin}	d _{amax}	d _{bmin}	D _{amax}	D _{amin}	r _{amax}				r _{bmax}	A1	A2
mm						kg	kg	mm			
51.5	53	61	78.5		1	1	0.639				
51.5	53	61	78.5		1	1	0.645				
51	53	58	79		1	1	0.831				
51	53	58	79		1	1	0.843				
53	84		92	90.5	1.5	1.5	0.920				
53	84		92	90.5	1.5	1.5	0.820				
53	84		92	90.5	1.5	1.5	0.872				
53	56	67	92		1.5	1.5	0.891				
53	84		92	90.5	1.5	1.5	0.872				
53	56	61	92		1.5	1.5	0.992				
53	56	67	92		1.5	1.5	1.00				
53	86		92	91	1.5	1.5	0.959				
53		67	92		1.5	1.5	1.01				
53	86		92	91	1.5	1.5	0.964				
53	86		92	91	1.5	1.5	0.846				
53			92	91	1.5	1.5	0.995				
53	56	67	92		1.5	1.5	1.01				
53	56	67	92		1.5	1.5	1.09				
53	56	61	92		1.5	1.5	0.986				
51	54	60	92		1.5	1.5	0.912				
53		67	92		1.5	1.5	0.892				
53		67	92		1.5	1.5	0.942				
53			92	91	1.5	1.5	1.12				
53	56	61	93		1	1	1.49				
53	56	67	92		1.5	1.5	1.45				
53	56	67	92		1.5	1.5	1.17				
53	56	67	92		1.5	1.5	1.52				
53	56	67	92		1.5	1.5	1.47				
53	56	61	93		1.5	1.5	1.42				
53	84		92	90.5	1.5	1.5	1.03				
54	97		111	103	2	2	1.67				
54	62	67	111		2	2	1.87				
54	62	74	111		2	2	1.88				
54	56	60	75		1	0.6	0.316				
54	56	60	75		1	0.6	0.279				

Single-row Cylindrical Roller Bearing

d 50 mm

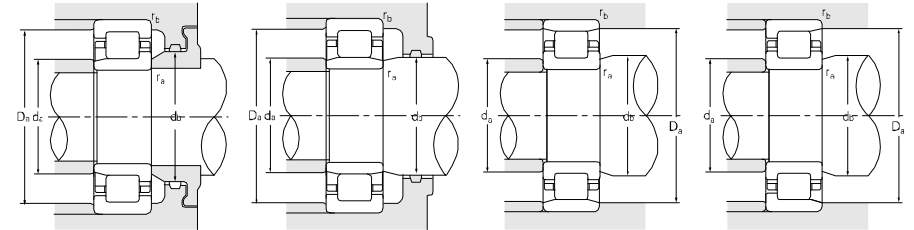
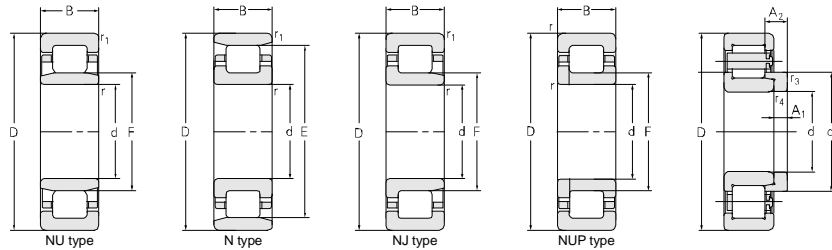

Principal dimensions						Basic load ratings		Limit speed ratings		Designations
d	D	B	r _{1smin}	r _{smin}	F	E	C _r	C _{0r}	Grease	
mm						kN		r/min		
50	80	16	1	1	60.5	45	54	8500	10000	N1010KM/P49
90	20	1.1	1.1	80.4	57.2	64.0	6300	7500	N210M	
90	20	1.1	1.1	81.5	70.5	67.5	6300	7500	N210EM	
90	20	1.1	1.1	80.4	57.2	64.0	6300	7500	NF210M	
90	20	1.1	1.1	60.4	57.2	64.0	6300	7500	NU210M	
90	20	1.1	1.1	60.4	57.2	64.0	6300	7500	NU210Q1	
90	20	1.1	1.1	59.5	70.5	67.5	6300	7500	NU210EM	
90	20	1.1	1.1	59.5	70.5	67.5	6300	7500	NJ210EM	
90	20	1.1	1.1	59.5	70.5	67.5	6300	7500	NJ210ETN1	
90	20	1.1	1.1	81.5	70.5	67.5	6300	7500	NF210E	
90	20	1.1	1.1	81.5	70.5	67.5	6300	7500	NF210EM	
90	20	1.1	1.1	59.5	70.5	67.5	6300	7500	NUP210E	
90	23	1.1	1.1	59.5	86.5	84.5	6300	7500	NU2210EM	
90	23	1.1	1.1	59.5	86.5	84.5	6300	7500	NU2210ETN1/C9	
90	23	1.1	1.1	59.5	86.5	84.5	6300	7500	NJ2210EM	
90	23	1.1	1.1	59.5	86.5	84.5	6300	7500	NJ2210ETN1	
90	30.16	1.1	1.1	60.45	99.0	128	6300	7500	NU5210XPC3	
90	30.16	1.1	1.1	60.45	99.0	128	6300	7500	NU3210X2M/C9YA6	
100	33.34	1.5	1.1	66.9	118	155	6000	7000	NU5211XPC3	
100	32	2	2	65	112	116	5000	6000	NU310EWBTN1	
110	27	2	2	95	122	108	5000	6000	N310M	
110	27	2	2	95	122	108	5000	6000	NF310M	
110	27	2	2	65	122	108	5000	6000	NJ310M	
110	27	2	2	65	122	108	5000	6000	NJ310M+HJ310	
110	27	2	2	65	122	108	5000	6000	NU310M/C3	
110	27	2	2	97	122	108	5000	6000	N310EM	
110	27	2	2	97	122	108	5000	6000	N310E	
110	27	2	2	65	122	108	5000	6000	NJ310E	
110	27	2	2	65	122	108	5000	6000	NU310E	
110	27	2	2	65	122	108	5000	6000	NU310EM	
110	27	2	2	65	122	108	5000	6000	NUP310EM	
110	27	2	2	65	122	108	5000	6000	NUP310M	
110	27	2	2	65	122	108	5000	6000	NJ310TN1	
110	27	2	2	65	122	108	5000	6000	NU310TN1	
110	40	2	2	65	180	180	5000	6000	NU2310M	
110	40	2	2	65	180	180	5000	6000	NJ2310E	

Abutment and fillet dimensions						Weight	Model	Weight	Separate thrust collar		
d _{amin}	d _{amax}	d _{bmin}	D _{amax}	D _{amin}	r _{amax}				r _{bmax}	A1	A2
mm						kg	kg	mm			
54	56	75	1	1	0.309						
56.5	79	83.5	82	1	0.559						
56.5	79	83.5	82	1	0.566						
56.5		83.5	82	1	0.565						
56.5	57	62	83.5	1	0.564						
56.5	57	62	83.5	1	0.557						
56.5	57	62	83.5	1	0.562						
56.5	57	66	83.5	1	0.573						
56.5	57	66	83.5	1	0.503						
56.5		83.5	82	1	0.578						
56.5		83.5	82	1	0.596						
56.5		66	83.5	1	0.591						
56.5	57	62	83.5	1	0.65						
56.5	57	66	83.5	1	0.563						
56.5	57	66	83.5	1	0.666						
56.5	57	66	83.5	1	0.579						
56	58	62	84	1	0.902						
56	58	62	84	1	0.902						
60	62	94	1	1	1.21						
59	63	67	101	2	1.19	HJ310E	0.152	8	12.74	2	
59	93	101	97	2	1.17						
59	93	101	97	2	1.31	HJ310	0.158	8	13.74	2	
59	63	73	101	2	1.36	HJ310	0.158	8	13.74	2	
59	63	73	101	2	1.52	HJ310	0.158	8	13.74	2	
59	63	67	101	2	1.29						
59	95	101	99	2	1.30						
59	95	101	99	2	1.30	HJ310E	0.152	8	12.74	2	
59	63	73	101	2	1.33	HJ310E	0.152	8	12.74	2	
59	63	67	101	2	1.29	HJ310E	0.152	8	12.74	2	
59	63	67	101	2	1.27						
59	63	67	101	2	1.34						
61	73	99	2	2	1.37	HJ310	0.158	8	13.74	2	
59	63	73	101	2	1.14	HJ310	0.158	8	13.74	2	
59	63	67	101	2	1.10						
59	61	67	101	2	1.91						
59	62	73	101	2	1.95						

Single-row Cylindrical Roller Bearing

d 50-55 mm

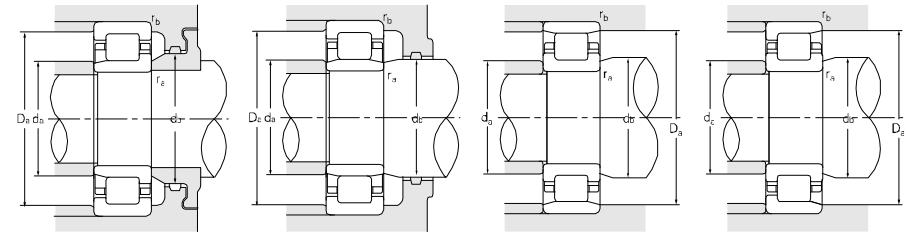
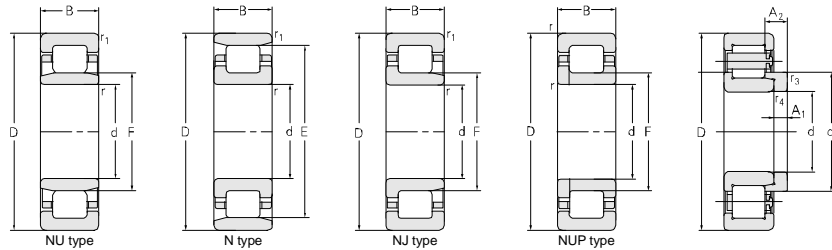

Principal dimensions						Basic load ratings		Limit speed ratings		Designations	
d	D	B	r _{1smin}	r _{smin}	F	E	C _r	C _{0r}	Grease		Oil
mm						kN		r/min			
50	110	40	2	2	65		180	180	5000	6000	NJ2310EM
	110	40	2	2	65		180	180	5000	6000	NU2310E
	110	40	2	2	65		180	180	5000	6000	NU2310EM
	110	40	2	2	65		180	180	5000	6000	NU2310ETN1
	110	40	2	2	65		180	180	5000	6000	NJ2310ETN1
	130	31	2.1	2.1		110	150	150	5000	6000	N410M
	130	31	2.1	2.1		110	150	150	5000	6000	N410
	130	31	2.1	2.1	70		150	150	5000	6000	NU410M
	130	31	2.1	2.1	70		150	150	5000	6000	NU410
	130	31	2.1	2.1	70		150	150	5000	6000	NJ410
	130	31	2.1	2.1	70		150	150	5000	6000	NJ410M
	130	31	2.1	2.1	70		150	150	5000	6000	NJ410TN1
	130	31	2.1	2.1	70		150	150	5000	6000	NU410TN1
	55	90	18	1.1	1	64.5		55	67	7000	8500
90		18	1.1	1	64.5		55	67	7000	8500	NU1011TN1
100		21	1.5	1.5		88.5	93	91	6000	7000	NF211M
100		21	1.5	1.5		90	93	91	6000	7000	NF211E
100		21	1.5	1.1	66		93	91	6000	7000	NJ211E
100		21	1.5	1.5	66		93	91	6000	7000	NUP211E
100		21	1.5	1.5	66		93	91	6000	7000	NUP211EM
100		21	1.5	1.5	66		93	91	6000	7000	NU211ETN1/C9
100		21	1.5	1.5	66		93	91	6000	7000	NUP211ETN1
100		21	1.5	1.1	66		93	91	6000	7000	NJ211ETN1
100		25	1.5	1.1	66		109	113	6000	7000	NJ221EM
100		25	1.5	1.1	66		109	113	6000	7000	NJ221ETN1
100		25	1.5	1.1	66		109	113	6000	7000	NU2211EM
100		33.3	1.5	1.1		88.9	117	155	4800	7000	N3211M
100		33.34	1.1	1.1	66.9		118	155	4800	5600	NU5211XPC3
100		33.34	1.1	1.1	66.9		118	155	4800	5600	NU3211X2M/C9YA6
120		29	2	2		104.5	150	137	4800	5600	NF311M
120		29	2	2		104.5	150	137	4800	5600	N311M
120		29	2	2		104.5	150	137	4800	5600	N311J
120		29	2	2	70.5		150	137	4800	5600	NU311M
120		29	2	2	70.5		150	137	4800	5600	NJ311M
120		29	2	2	70.5		150	137	4800	5600	NUP311M

Abutment and fillet dimensions							Weight	Model	Weight	Separate thrust collar		
damin	damax	dbmin	Damax	Damin	ramax	rbmax				A1	A2	r _{3,4}
mm							kg	kg	mm			
59	62	73	101		2	2	1.92					
59	61	62	67	101	2	2	1.92					
59	61	67	101		2	2	1.89					
59	61	67	101		2	2	1.71					
59	62	73	101		2	2	1.74					
61	107		119	113	2	2	2.18					
61	107		119	113	2	2	2.09					
61	68	73	119		2	2	2.20					
61	68	73	119		2	2	2.11					
61	68	81	119		2	2	2.15					
61	68	81	119		2	2	2.24					
61	68	81	119		2	2	2.02					
61	68	73	119		2	2	1.99					
59.6	63	67	84		1	1	0.479					
59.6	63	67	84		1	1	0.403					
63			93.5	92	1.5	1.5	0.806					
63			93.5	92	1.5	1.5	0.757					
61.5	64	73	92		1.5	1	0.767					
61.5	64	73	92		1	1	0.751					
61.5	64	73	92		1	1	0.762					
61.5	64	73	92		1	1	0.67					
61.5	64	73	92		1	1	0.667					
61.5	64	73	92		1.5	1	0.701					
61.5	64	73	92		1.5	1	0.783					
61.5	64	73	92		1.5	1	0.666					
61.5	64	68	92		1.5	1	0.763					
63	87		93.5	92	1.5	1	1.20					
61	65	69	93		1	1	1.21					
61	65	69	93		1	1	1.21					
64			111	107	2	2	1.7					
64	102		111	107	2	2	1.65					
64	102		111	107	2	2	1.45					
64	68	73	111		2	2	1.74					
64	68	79	111		2	2	1.75					
64	68	79	111		2	2	1.76					

Single-row Cylindrical Roller Bearing

d 55-60 mm

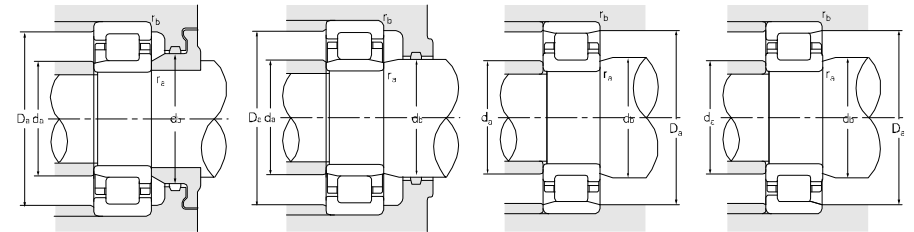
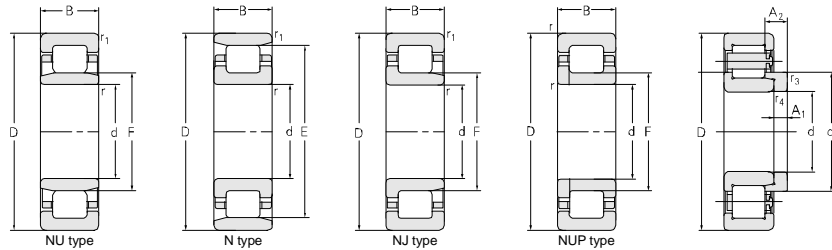

Principal dimensions						Basic load ratings		Limit speed ratings		Designations	
d	D	B	r _{1smin}	r _{smin}	F	E	C _r	C _{0r}	Grease		Oil
mm						kN		r/min			
55	120	29	2	2	70.5	150	137	4800	5600	NJ311M/YA6	
	120	29	2	0.5	68.75	150	137	4800	5600	NUP311NJJC	
	120	29	2	2	68.75	150	137	4800	5600	NUP311NRJC	
	120	29	2	2		106.5	150	137	4800	5600	N311EM
	120	29	2	2	106.5	150	137	4800	5600	N311E	
	120	29	2	2	70.5	150	137	4800	5600	NJ311TN1/YA6	
	120	29	2	2	70.5	150	137	4800	5600	NU311ETN1/C9	
	120	29	2	2	70.5	150	137	4800	5600	NU311TN1	
	120	29	2	2	70.5	150	137	4800	5600	NJ311E	
	120	29	2	2	70.5	150	137	4800	5600	NU311E	
	120	29	2	2	70.5	150	137	4800	5600	NUP311E	
	120	29	2	2	106.5	150	137	4800	5600	N311ETN1	
	120	29	2	2	70.5	150	137	4800	5600	NU311EM	
	120	29	2	2	70.5	150	137	4800	5600	NU311EM/C9	
	120	43	2	2	70.5	156	174	4800	5600	NU2311M	
	120	43	2	2	106.5	223	246	4800	5600	N2311E	
	120	43	2	2	70.5	223	246	4800	5600	NJ2311E	
	120	43	2	2	70.5	223	246	4800	5600	NU2311E	
	140	33	2.1	2.1	117.2	162	168	4800	5600	N411M	
	140	33	2.1	2.1	77.2	162	168	4800	5600	NJ411M/C5	
140	33	2.1	2.1	77.2	162	168	4800	5600	NU411M		
60	95	18	1.1	1	85.5	50.6	66.0	6700	8000	N1012M	
	95	18	1.1	1	85.5	50.6	66	6700	8000	N1012TN1	
	95	18	1.1	1	69.5	50.6	66.0	6700	8000	NU1012M	
	110	22	1.5	1.5	100	104	85	5300	6300	N212EM	
	110	22	1.5	1.5	97.5	104	85	5300	6300	N212M	
	110	22	1.5	1.5	97.5	104	85	5300	6300	NF212M	
	110	22	1.5	1.5	73.5	104	85	5300	6300	NU212M	
	110	22	1.5	1.5	72	104	85	5300	6300	NU212EM	
	110	22	1.5	1.5	73.5	104	85	5300	6300	NJ212M	
	110	22	1.5	1.5	72	104	85	5300	6300	NJ212E	
	110	22	1.5	1.5	72	104	85	5300	6300	NJ212EM	
	110	22	1.5	1.5	72	104	85	5300	6300	NJ212ETN1	
	110	22	1.5	1.5	72	104	85	5300	6300	NU212ETN1/C9	
	110	22	1.5	1.5	73.5	104	85	5300	6300	NUP212NM/YB2	

Abutment and fillet dimensions						Weight	Model	Weight	Separate thrust collar		
d _{amin}	d _{amax}	d _{bmin}	D _{amax}	D _{amin}	r _{amax}				r _{bmax}	A1	A2
mm						kg	kg	mm			
64	68	80	111		2	2	1.75				
64		80	111		2	2	1.65				
64		80	111		2	2	1.71				
64	104		111	109	2	2	1.60				
64	104		111	109	2	2	1.61				
64	68	80	111		2	2	1.45				
64	68	73	111		2	2	1.45				
64	68	73	111		2	2	1.44				
64	68	80	111		2	2	1.67				
64	68	73	111		2	2	1.64				
64	68	80	111		2	2	1.69				
64	104		111	109	2	2	1.42				
64	68	73	111		2	2	1.64				
64	68	73	111		2	2	1.63				
64	68	73	111		2	2	2.43				
64	104		111	110	2	2	2.56				
64	68	80	111		2	2	2.62				
64	68	73	111		2	2	2.59				
66	114		129	119	2	2	2.86				
66	74	88	129		2	2	2.95				
66	74	88	129		2	2	2.85				
65	83		88.5	87	1	1	0.432				
65	83		88.5	87	1	1	0.387				
65	67	72	90		1	1	0.466				
65	70		102		1.5	1.5	0.910				
68			102		1.5	1.5	0.937				
68			102		1.5	1.5	0.957				
68	70	75	102		1.5	1.5	0.938				
68	70	80	102		1.5	1.5	0.916				
68	70	80	102		1.5	1.5	0.952				
68	70	80	102		1.5	1.5	0.947				
68	70	80	102		1.5	1.5	0.938				
68	70	80	102		1.5	1.5	0.842				
68	70	80	102		1.5	1.5	0.820				
68	70	80	102		1.5	1.5	0.978				

Single-row Cylindrical Roller Bearing

d 60 mm

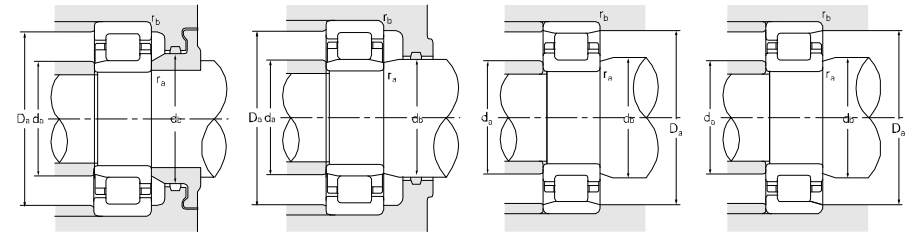
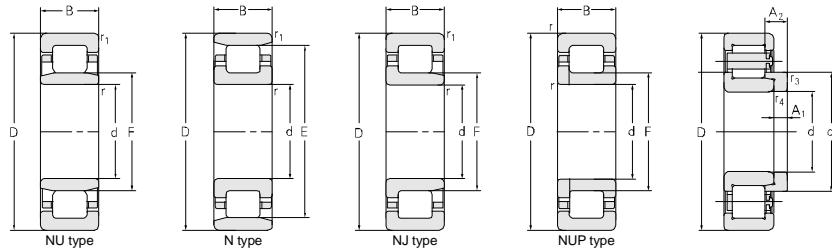

Principal dimensions						Basic load ratings		Limit speed ratings		Designations	
d	D	B	r _{1smin}	r _{smin}	F	E	C _r	C _{0r}	Grease		Oil
mm						kN		r/min			
60	110	28		1.5	73.5		140	145	5300	6300	NUP2212M
	110	28	1.5	1.5	72		140	145	5300	6300	NU2212EM
	110	28	1.5	1.5	72		140	145	5300	6300	NJ2212EM
	110	28	1.5	1.5	72		140	145	5300	6300	NJ2212ETN1
	110	36.51	1.5	1.5	72.39		150	195	4800	5600	NU5212XPC3
	110	36.51	1.5	1.5	72.39		150	195	4800	5600	NU3212X2M/C9YA6
	110	60	1.5	1.5	73.5		105	130	5300	6300	NU2212WBM/C3
	130	31	2.1	2.1		113	165	150	4300	5000	N312M
	130	31	2.1	2.1	77		141	150	4300	5000	NU312M
	130	31	2.1	2.1	77		141	150	4300	5000	NU312Q1
	130	31	2.1	2.1	77		141	150	4300	5000	NJ312M
	130	31	2.1	2.1		115	165	155	4300	5000	N312E
	130	31	2.1	2.1		115	165	155	4300	5000	N312EM
	130	31	2.1	2.1		115	165	155	4300	5000	N312ETN1
	130	31	2.1	2.1		115	165	155	4300	5000	NF312E
	130	31	2.1	2.1		115	165	155	4300	5000	NF312EM
	130	31	2.1	2.1	77		165	155	4300	5000	NJ312E
	130	31	2.1	2.1	77		165	155	4300	5000	NJ312EM/YAB
	130	31	2.1	2.1	77		165	155	4300	5000	NU312E
	130	31	2.1	2.1	77		165	155	4300	5000	NU312EM
	130	31	2.1	2.1	77		165	155	4300	5000	NU312ETN1
	130	31	2.1	2.1	77		165	155	4300	5000	NU312ETN1/C9
	130	31	2.1	2.1	77		165	155	4300	5000	NUP312E
	130	31	2.1	2.1	77		165	155	4300	5000	NUP312E/C9
	130	31	2.1	2.1	77		165	155	4300	5000	NUP312ENRM
	130	31	2.1	2.1	77		165	155	4300	5000	NUP312ENR/J/C3
	130	31	2.1	2.1		113	140	150	4300	5000	N312TN1
	130	31	2.1	2.1	77		140	150	4300	5000	NJ312TN1
	130	46	2.1	2.1		113	190	215	4300	5000	N2312M
	130	46	2.1	2.1	77		190	215	4300	5000	NJ2312M/C4W124YA8
	130	46	2.1	2.1	77		190	215	4300	5000	NJ2312M
	130	46	2.1	2.1	78		190	215	4300	5000	NJ2313M
	130	46	2.1	2.1		115	250	255	4300	5000	N2312E
	130	46	2.1	2.1	77		250	255	4300	5000	NU2312ETN1/C9
	130	46	2.1	2.1	77		250	255	4300	5000	NU2312E
	130	46	2.1	2.1	77		250	255	4300	5000	NJ2312E

Abutment and fillet dimensions						Weight	Model	Weight	Separate thrust collar		
d _{amin}	d _{amax}	d _{bmin}	D _{amax}	D _{amin}	r _{amax}				r _{bmax}	A1	A2
mm						kg	kg	mm			
68		80	102		1.5	1.5	1.27				
68	70	74	102		1.5	1.5	1.21				
68	70	80	102		1.5	1.5	1.23				
68	70	80	102		1.5	1.5	1.07				
66	70	75	103		1	1	1.75				
66	70	75	103		1	1	1.75				
68	70	74	102		1.5	1.5	1.57				
71	110			116	2	2	2.04				
71	72	80	119		2	2	2.06				
71	72	80	119		2	2	2.03				
71	72	86	119		2	2	2.10				
71	112			118	2	2	1.94				
71	112			118	2	2	2.06				
71	112			118	2	2	1.79				
71				118	2	2	2.00				
71				118	2	2	2.12				
71	74	87	119		2	2	1.98				
71	74	87	119		2	2	2.10				
71	74	79	119		2	2	1.94				
71	74	79	119		2	2	2.06				
71	74	79	119		2	2	1.78				
71	74	79	119		2	2	1.78				
71		87	119		2	2	2.03				
71		87	119		2	2	2.03				
71		87	119		2	2	2.2				
71		87	119		2	2	1.92				
71	110			116	2	2	1.78				
71	72	86	119		2	2	1.83				
71	110			117	2	2	2.95				
71	73	80	119		2	2	3.39				
71	73	87	119		2	2	3.38				
71	73	87	119		2	2	3.39				
71	112			118	2	2	2.93				
71	112			118	2	2	2.79				
71	73	80	119		2	2	2.95				
71	73	87	119		2	2	3.00				

Single-row Cylindrical Roller Bearing

d 60-65 mm

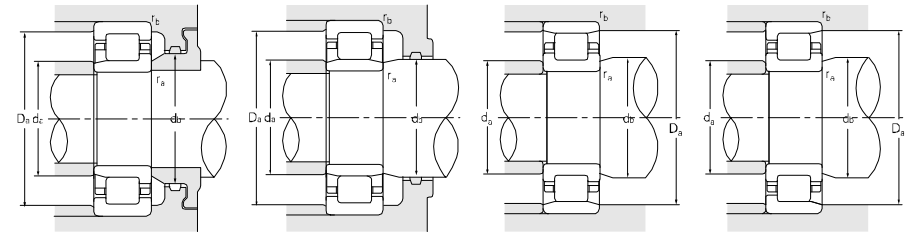
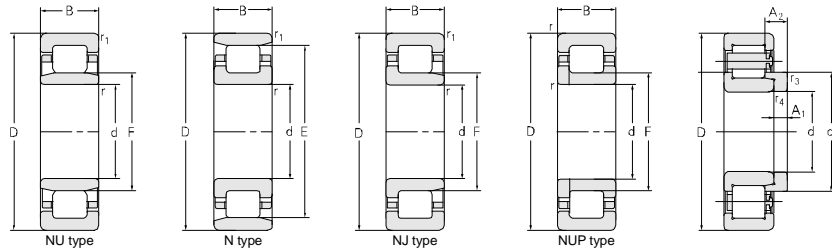

Principal dimensions						Basic load ratings		Limit speed ratings		Designations	
d	D	B	r _{1smin}	r _{smin}	F	E	C _r	C _{0r}	Grease		Oil
mm						kN		r/min			
60	140	51	2.5	2.5		122	270	310	4300	5000	N612M
	140	51	2.5	2.5		122	270	310	4300	5000	N612M/C9
	150	35	2.1	2.1		127	195	200	4300	5000	N412M
	150	35	2.1	2.1		127	195	200	4300	5000	N412
	150	35	2.1	2.1	83		195	200	4300	5000	NU412M
	150	35	2.1	2.1	83		195	200	4300	5000	NU412
	150	35	2.1	2.1	83		195	200	4300	5000	NJ412J
	150	35	2.1	2.1	83		195	200	4300	5000	NJ412M
	150	35	2.1	2.1	83		195	200	4300	5000	NJ412
	150	35		2.1	83		195	200	4300	5000	NUP412
	150	35		2.1	83		195	200	4300	5000	NUP412J
	150	35		2.1	83		195	200	4300	5000	NUP412M
	150	35	2.1	2.1	83		195	200	4300	5000	NU412TN1
	65	120	23	1.5	1.5		105.6	89	102	4800	5600
120		23	1.5	1.5	79.6		89	102	4800	5600	NU213M
120		23	1.5	1.5	79.6		89	102	4800	5600	NJ213M
120		23	1.5	1.5	79.6		89	102	4800	5600	NUP213M
120		23	1.5	1.5		108.5	120	135	4800	5600	NF213E
120		23	1.5	1.5		108.5	120	135	4800	5600	N213E
120		23	1.5	1.5	78.5		120	135	4800	5600	NU213E
120		23	1.5	1.5	78.5		120	135	4800	5600	NJ213E
120		23	1.5	1.5	78.5		120	135	4800	5600	NUP213E
120		23	1.5	1.5	78.5		120	135	4800	5600	NUP213EM
120		23	1.5	1.5	78.5		120	135	4800	5600	NUP213ETN1
120		23	1.5	1.5	78.5		120	135	4800	5600	NU213ETN1/C9
120		23	1.5	1.5	78.5		120	135	4800	5600	NU213ETN1
120		31	1.5	1.5	79.6		122	155	4800	5600	NJ2213M
120		31	1.5	1.5	79.6		122	155	4800	5600	NU2213M
120		31	1.5	1.5	79.6		131	165	4800	5600	NU2213NM
120		31	1.5	1.5	79.6		131	165	4800	5600	NUP2213M
120		31	1.5	1.5	78.5		163	173	4800	5600	NU2213ETN1/C9
120		31	1.5	1.5	78.5		122	154	4800	5600	NUP2213NM
120		31	1.5	1.5	78.5		163	173	4800	5600	NU2213EM
120		38.1	1.5	1.5	80.42		166	218	4000	4800	NU5213XPC3
120		38.1	1.5	1.5	80.42		166	218	4000	4800	NU3213M/C9YA6

Abutment and fillet dimensions							Weight	Model	Weight	Separate thrust collar		
d _{amin}	d _{amax}	d _{bmin}	D _{amax}	D _{amin}	r _{amax}	r _{bmax}				A1	A2	r _{3,4}
mm							kg	kg	mm			
72	119		128	125	2	2	3.96					
72	119		128	125	2	2	3.96					
71	124		139	130	2	2	3.29					
71	124		139	130	2	2	3.18					
71	80	85	139		2	2	3.23					
71	80	85	139		2	2	3.13					
71	80	94	139		2	2	3.13					
71	80	94	139		2	2	3.36					
71	80	94	139		2	2	3.25					
71		94	139		2	2	3.43					
71		94	139		2	2	3.31					
71		94	139		2	2	3.42					
71	80	85	139		2	2	2.91					
73	103		112	111	1.5	1.5	1.11					
73	76	81	112		1.5	1.5	1.12					
73	76	87	112		1.5	1.5	1.14					
73		87	112		1.5	1.5	1.22					
73			112	111	1.5	1.5	1.14					
73	106		112	111	1.5	1.5	1.05					
73	76	81	112		1.5	1.5	0.994					
73	76	87	112		1.5	1.5	1.13					
73		87	112		1.5	1.5	1.16					
73		87	112		1.5	1.5	1.22					
73		87	112		1.5	1.5	1.07					
73		87	112		1.5	1.5	1.02					
73	76	81	112		1.5	1.5	1.00					
73	76	87	112		1.5	1.5	1.65					
73	76	81	112		1.5	1.5	1.65					
73		87	112		1.5	1.5	1.64					
73		87	112		1.5	1.5	1.75					
73	76	81	112		1.5	1.5	1.43					
73	76	81	112		1.5	1.5	1.74					
73	76	81	112		1.5	1.5	1.61					
72	78.5	82.5	113.5		1	1	1.96					
72	78.5	82.5	113.5		1	1	1.96					

Single-row Cylindrical Roller Bearing

d 65-70 mm

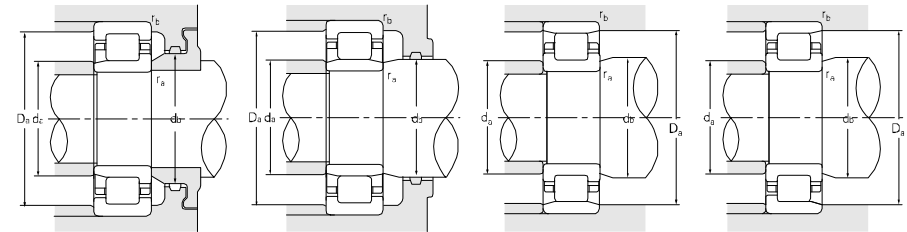
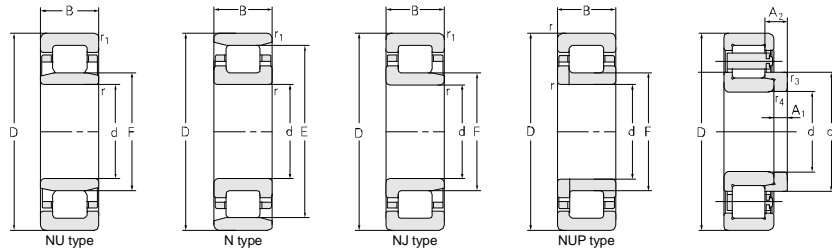

Principal dimensions						Basic load ratings		Limit speed ratings		Designations	
d	D	B	r _{1smin}	r _{smin}	F	E	C _r	C _{0r}	Grease		Oil
mm						kN		r/min			
65	140	33	2.1	2.1		121.5	156	168	4000	4800	N313
	140	33	2.1	2.1		121.5	156	168	4000	4800	N313M
	140	33	2.1	2.1		121.5	195	210	4000	4800	N313ETN1
	140	33	2.1	2.1	83.5		156	168	4000	4800	NJ313M
	140	33	2.1	2.1	83.5		156	168	4000	4800	NU313M
	140	33	2.1	2.1	83.5		156	168	4000	4800	NU313Q1
	140	33	2.1	2.1	82.5		205	188	4000	4800	NJ313EM
	140	33	2.1	2.1		124.5	205	188	4000	4800	N313EM
	140	33	2.1	2.1		124.5	205	188	4000	4800	NF313EM
	140	33	2.1	2.1	82.5		205	188	4000	4800	NU313EM
	140	33	2.1	2.1	82.5		205	188	4000	4800	NU313ETN1
	140	33	2.1	2.1		124.5	205	188	4000	4800	N313E
	140	33	2.1	2.1	82.5		205	188	4000	4800	NJ313E
	140	33	2.1	2.1	82.5		205	188	4000	4800	NU313E
	140	33	2.1	2.1	82.5		205	188	4000	4800	NUP313EM
	140	33	2.1	2.1	83.5		205	188	4000	4800	NU313M/YA1
	140	48	2.1	2.1	83.5		211	248	4000	4800	NJ2313M
	140	48	2.1	2.1	83.5		211	248	4000	4800	NU2313M
	140	48	2.1	2.1	83.5		274	278	4000	4800	NU2313ETN1
	140	48	2.1	2.1	83.5		274	278	4000	4800	NU2313ETN1/C9
	140	48	2.1	2.1		124.5	274	278	4000	4800	NF2313E
	140	48	2.1	2.1	82.5		274	278	4000	4800	NJ2313E
	140	48	2.1	2.1	82.5		274	278	4000	4800	NU2313E
	160	37	2.1	2.1		135.5	209	222	4000	4800	N413M
	160	37	2.1	2.1		135.5	209	222	4000	4800	N413
	160	37	2.1	2.1	89.5		209	222	4000	4800	NU413M
	160	37	2.1	2.1	89.5		209	222	4000	4800	NU413
	160	37	2.1	2.1	89.5		209	222	4000	4800	NJ413M
	160	37	2.1	2.1	89.5		209	222	4000	4800	NJ413M/YA8
	160	37	2.1	2.1	89.5		209	222	4000	4800	NJ413W1
160	37	2.1	2.1	89.5		209	222	4000	4800	NUP413M	
70	110	20	1.1	1.1	80	73.5	89.5	4600	5500	NU1014M	
	125	24	1.5	1.5	84.5	92.4	96	4500	5300	NUP214M	
	125	24	1.5	1.5		110.5	92.4	110	4500	5300	N214M
	125	24	1.5	1.5		110.5	92.4	110	4500	5300	NF214M

Abutment and fillet dimensions							Weight	Model	Weight	Separate thrust collar		
d _{amin}	d _{amax}	d _{bmin}	D _{amax}	D _{amin}	r _{amax}	r _{bmax}				A1	A2	r _{3,4}
mm							kg	kg	mm			
76	119		129	124	2	2	2.24					
76	119		129	124	2	2	2.45					
76	119		129	124	2	2	2.15					
76	81	93	129		2	2	2.60					
76	81	86	129		2	2	2.54					
76	81	86	129		2	2	2.46					
76	80	93	129		2	2	2.5					
76	122		129	127	2	2	2.42					
76	122		129	127	2	2	2.48					
76	80	85	129		2	2	2.45					
76	80	85	129		2	2	2.18					
76	122		129	127	2	2	2.43					
76	80	93	129		2	2	2.59					
76	80	85	129		2	2	2.46					
77		93	128		2	2	2.64					
76	81	86	129		2	2	2.46					
76	79	93	129		2	2	3.67					
76	79	85	129		2	2	3.60					
76	79	85	129		2	2	3.26					
76	79	85	129		2	2	3.26					
76			129	127	2	2	3.60					
76	79	93	129		2	2	3.55					
76	79	85	129		2	2	3.48					
76	132		149	139	2	2	4.01					
76	132		149	139	2	2	3.92					
76	86	92	149		2	2	4.03					
76	86	92	149		2	2	3.94					
76	86	101	149		2	2	4.09					
76	86	101	149		2	2	4.01					
76	86	101	149		2	2	4.00					
76		101	149		2	2	4.19					
75	76		104		1	1	0.69					
78		92	117		1.5	1.5	1.35					
78	108		117	116	1.5	1.5	1.27					
78			117	116	1.5	1.5	1.30					

Single-row Cylindrical Roller Bearing

d 70 mm

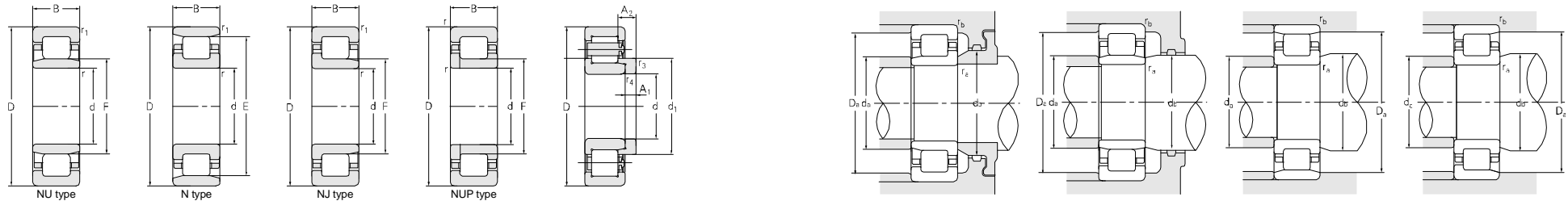

Principal dimensions						Basic load ratings		Limit speed ratings		Designations	
d	D	B	r _{1smin}	r _{smin}	F	E	C _r	C _{0r}	Grease		Oil
mm	mm	mm	mm	mm	mm	mm	kN		r/min		
70	125	24	1.5	1.5	84.5		92.4	116	4500	5300	NU214Q1
	125	24	1.5	1.5	84.5		92.4	116	4500	5300	NU214M
	125	24	1.5	4.3		113.5	132	152	4500	5300	NF214E/J/C9YB2
	125	24	1.5	1.5		113.5	132	152	4500	5300	N214E
	125	24	1.5	1.5		113.5	132	152	4500	5300	NF214E
	125	24	1.5	4.3		113.5	132	152	4500	5300	NF214E/C9YB2
	125	24	1.5	4.3		113.5	132	152	4500	5300	NF214ETN1/C9YB2
	125	24		1.5	83.5		132	152	4500	5300	NUP214E
	125	24	1.5	1.5	83.5		132	152	4500	5300	NJ214E
	125	24	1.5	1.5	83.5		132	152	4500	5300	NU214ETN1/C9
	125	24	1.5	1.5	83.5		132	152	4500	5300	NJ214E/YA6
	125	24	1.5	1.5	83.5		132	152	4500	5300	NU214E
	125	31		1.5	84.5		130	155	4500	5300	NUP2214M
	125	31	1.5	1.5		110.5	130	155	4500	5300	N2214M
	125	31	1.5	1.5	84.5		130	155	4500	5300	NU2214M
	125	31	1.5	1.5	84.5		130	155	4500	5300	NJ2214M
	125	39.69	1.5	1.5	84.76		166	232	4500	5300	NU5214XPC3
	125	39.69	1.5	1.5	84.76		166	232	4500	5300	NU5214/C9YA6
	125	39.69	1.5	1.5	84.76		166	232	4500	5300	NU3214X2M/C9YA6
	125	41	1.5	1.5	84.5		130	155	4500	5300	NU2214WBM/C2
	150	35	2.1	2.1	90		182	202	3600	4300	NJ314Q1
	150	35	2.1	2.1		130	182	202	3600	4300	N314M
	150	35	2.1	2.1		130	182	202	3600	4300	N314J
	150	35	2.5	2.5	90		182	202	3600	4300	NU314M
	150	35	2.5	2.5	90		182	202	3600	4300	NJ314M
	150	35	2.1	2.1		130	182	202	3600	4300	NF314M
	150	35	2.1	2.1	90		182	202	3600	4300	NU314Q1
	150	35	3	2.1	90		182	202	3600	4300	NU314NRM/YAB
	150	35	2.1	2.1	90		185	202	3600	4300	NU314NM/YB2
	150	35	2.1	2.1	90		185	202	3600	4300	NU314NTN1/YB2
	150	35	2.1	2.1		133	226.5	220	3600	4300	N314E
	150	35	2.1	2.1		133	226.5	220	3600	4300	N314EM
	150	35	2.1	2.1	89		226.5	220	3600	4300	NJ314E/C9
	150	35	2.1	2.1	89		226.5	220	3600	4300	NU314E
	150	35	2.1	2.1	89		226.5	220	3600	4300	NJ314E
	150	35	2.1	2.1	89		226.5	220	3600	4300	NJ314EM/YAB

Abutment and fillet dimensions								Weight	Model	Weight	Separate thrust collar		
d _{amin}	d _{amax}	d _{bmin}	D _{amax}	D _{amin}	r _{amax}	r _{bmax}					A1	A2	r _{3,r4}
mm	mm	mm	mm	mm	mm	mm	kg	kg	mm	mm	mm		
78	81	86	117		1.5	1.5	1.23						
78	81	86	117		1.5	1.5	1.24						
78			117	116	4	1.5	1.21						
78	111		117	116	1.5	1.5	1.29						
78			117	116	1.5	1.5	1.31						
78			117	116	4	1.5	1.33						
78			117	116	4	1.5	1.17						
78		92	117		1.5	1.5	1.39						
78	81	92	117		1.5	1.5	1.34						
78	81	92	117		1.5	1.5	1.16						
78	81	92	117		1.5	1.5	1.34						
78	81	86	117		1.5	1.5	1.32						
78		92	117		1.5	1.5	1.8						
78	81		117	100	1.5	1.5	1.68						
78	81	86	117		1.5	1.5	1.70						
78	81	92	117		1.5	1.5	1.73						
76.5	82.5	86.5	118.5		1	1	2.17						
76.5	82.5	86.5	118.5		1	1	2.17						
76.5	82.5	86.5	118.5		1	1	2.17						
78	81	86	117		1.5	1.5	1.88						
81	86	100	139		2	2	3.11						
81	127		139	133	2	2	3.00						
81	127		139	133	2	2	2.78						
81	86	93	139		2	2	3.05						
81	86	100	139		2	2	3.12						
81			139		2	2	3.08						
81	86	92	139		2	2	3.03						
81	86	92	139		2	2	3.05						
81	86	93	139		2	2	2.96						
81	86	93	139		2	2	2.66						
81	130		139	136	2	2	3.00						
81	130		139	136	2	2	3.08						
81	86	100	139		2	2	3.06						
81	86	92	139		2	2	3.01						
81	86	100	139		2	2	3.06						
81	86	100	139		2	2	3.14						

Single-row Cylindrical Roller Bearing

d 70-75 mm

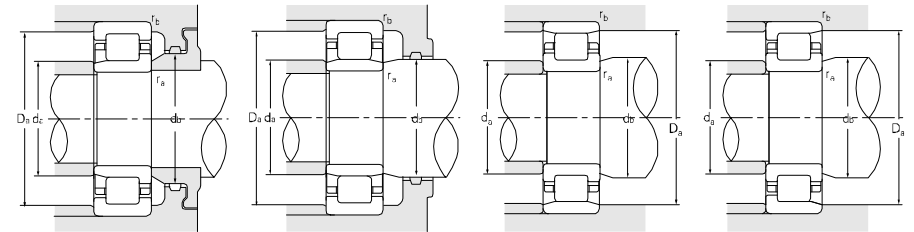
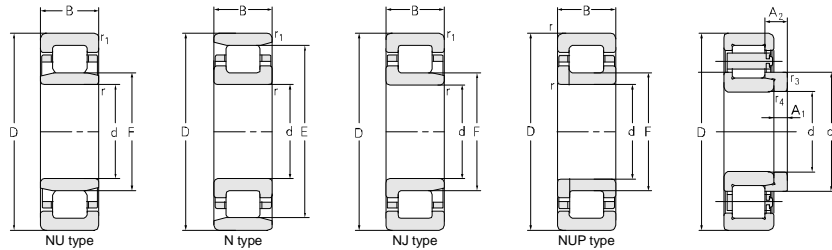

Principal dimensions						Basic load ratings		Limit speed ratings		Designations	
d	D	B	r _{1smin}	r _{smin}	F	E	C _r	C _{0r}	Grease		Oil
mm						kN		r/min			
70	150	35		2.1	89		226.5	220	3600	4300	NUP314E
	150	35	2.1	2.1	89		226.5	220	3600	4300	NU314EM
	150	35	2.1	2.1	89		226.5	220	3600	4300	NU314ETN1
	150	35	2.1	2.1	89		226.5	220	3600	4300	NU314ETN1/C9
	150	51	2.1	2.1	90		248	300	3600	4300	NU2314M
	150	51	2.1	2.1	90		248	300	3600	4300	NJ2314M
	150	51	2.1	2.1	90		248	300	3600	4300	NJ2314M/C4W124YA8
	150	51	2.1	2.1	89	133	302	345	3600	4300	N2314E
	150	51	2.1	2.1	89	133	302	345	3600	4300	NU2314ETN1/C9
	150	51	2.1	2.1	89	133	302	345	3600	4300	NU2314E
	150	51	2.1	2.1	89	133	302	345	3600	4300	NJ2314E
	150	51	2.1	2.1	86	133	320	370	3600	4300	NJ2314E/WBYAD
	180	42	3	3	3	151	262	283	3600	4300	N414M
	180	42	3	3	3	152	262	283	3600	4300	N414
	180	42	3	3	3	100	262	283	3600	4300	NU414M
	180	42	3	3	3	100	262	283	3600	4300	NU414
	180	42	3	3	3	100	262	283	3600	4300	NJ414
	180	42	3	3	3	100	262	283	3600	4300	NJ414M
	180	42	3	3	3	100	262	283	3600	4300	NJ414M/YA8
	180	42	3	3	3	100	262	283	3600	4300	NUP414M
75	115	20	1.1	1	85	65	83.0	5600	6700		NU1015M
	115.050	20	1.1	1		105	60	74	5600	6700	NF1015X1M
	130	25	1.5	1.5		116.5	107	127	4500	5300	N215M
	130	25	1.5	1.5	88.5	107	127	4500	5300		NU215M
	130	25	1.5	1.5	88.5	107	127	4500	5300		NJ215M
	130	25	1.5	1.5		118.5	144	150	4500	5300	N215E
	130	25	1.5	1.5	88.5	144	150	4500	5300		NU215E
	130	25	1.5	1.5	88.5	144	150	4500	5300		NU215ETN1
	130	25	1.5	1.5	88.5	144	150	4500	5300		NU215ETN1/C9
	130	25	1.5	1.5	88.5	144	150	4500	5300		NJ215E
	130	25	1.5	1.5	88.5	144	150	4500	5300		NU215EL3/HAP53
	130	25	1.5	1.5	88.5	144	150	4500	5300		NUP215EL3/HAP53
	130	30		1.5	88.5	132	166	4500	4500		NUP2215M
	130	30	1.5	1.5	88.5	164	211	4500	4500		NFP2215E
	130	30	1.5	1.5	88.5	164	211	4500	4500		NFP2215EM

Abutment and fillet dimensions						Weight	Model	Weight	Separate thrust collar		
da _{min}	da _{max}	db _{min}	Da _{max}	Da _{min}	ra _{max}				rb _{max}	A1	A2
mm						kg	kg	mm			
81		100	139		2	2	3.14				
82	86	91	138		2	2	3.45				
82	86	91	138		2	2	2.7				
82	86	91	138		2	2	2.7				
81	86	93	139		2	2	4.52				
81	86	101	139		2	2	4.62				
81	86	101	139		2	2	4.61				
81	130		139	136	2	2	4.27				
81	86	92	139		2	2	3.89				
81	86	92	139		2	2	4.24				
81	86	100	139		2	2	4.33				
81	86	101	139		2	2	4.51				
83	148		167	155	2.5	2.5	5.66				
83	148		167	155	2.5	2.5	6.40				
83	97	102	167		2.5	2.5	5.79				
83	97	102	167		2.5	2.5	6.38				
83	97	113	167		2.5	2.5	6.68				
83	97	113	167		2.5	2.5	5.94				
83	97	113	167		2.5	2.5	5.91				
83		102	167		2.5	2.5	6.17				
80	83	87	108.5		1	1	0.739				
80	83	87	108.5		1	1	0.765				
83	114		122	121	1.5	1.5	1.40				
83	86	91	122		1.5	1.5	1.42				
83	86	97	122		1.5	1.5	1.45				
83	116		122	121	1.5	1.5	1.38				
83	86	91	122		1.5	1.5	1.39				
83	86	91	122		1.5	1.5	1.24				
83	86	91	122		1.5	1.5	1.24				
83	86	97	122		1.5	1.5	1.38				
83	86	91	122		1.5	1.5	1.3				
83		97	122		1.5	1.5	1.35				
83		97	122		1.5	1.5	2.03				
83		97	122		1.5	1.5	1.81				
83		97	122		1.5	1.5	1.86				

Single-row Cylindrical Roller Bearing

d 75-80 mm

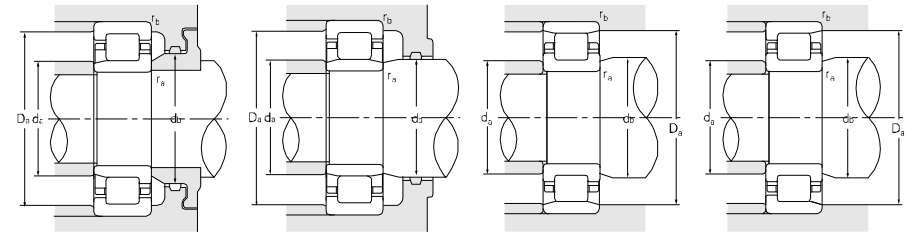
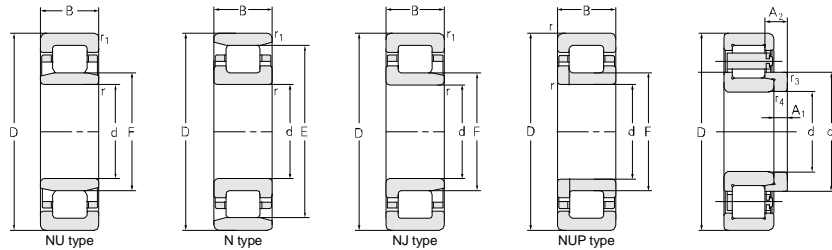

Principal dimensions	Basic load ratings						Limit speed ratings		Designations			
	d	D	B	r _{1smin}	r _{smin}	F	E	C _r		C _{0r}	Grease	Oil
mm	kN						r/min					
75	130	31	1.5	1.5	88.5	164	211	4500	4500	NU2215ETN1/C9		
	130	31	1.5	1.5	88.5	132	166	4500	5300	NU2215M		
	130	31	1.5	1.5	88.5	116.5	132	166	4500	5300	N2215M	
	130	31	1.5	1.5	88.5	132	166	4500	5300	NUP2215TN1		
	130	41.28	1.5	1.5	89	204	268	4000	4000	NU5215XPC3		
	130	41.28	1.5	3	89	204	268	4000	4000	NU3215X2M/C9YA6		
	160	37	2.1	2.1	95.5	204	226	3400	4000	NJ315Q1		
	160	37	2.1	2.1	139.5	269	254	3400	4000	N315EM		
	160	37	2.1	2.1	139.5	204	226	3400	4000	N315J		
	160	37	2.1	2.1	95	269	254	3400	4000	NU315EM		
	160	37	2.1	2.1	95.5	204	226	3400	4000	NU315Q1		
	160	37	2.1	2.1	143	269	254	3400	4000	N315E		
	160	37	2.1	2.1	95	269	254	3400	4000	NU315ETN1		
	160	37	2.1	2.1	95	269	254	3400	4000	NU315ENM		
	160	37	2.1	2.1	95	269	254	3400	4000	NUP315EM		
	160	37	2.1	2.1	139.5	255	226	3400	4000	N315M		
	160	37	2.1	2.1	95.5	255	226	3400	4000	NU315M		
	160	37	2.1	2.1	95	269	254	3400	4000	NU315E		
	160	37	2.1	2.1	95.5	255	226	3400	4000	NJ315M		
	160	46	2.1	2.1	95	269	303	3400	4000	NJ315X2EM/YAB		
	160	37	2.1	2.1	95	269	254	3400	4000	NJ315E		
	160	55	2.1	2.1	139.5	287	345	3400	4000	N2315M		
	160	55	2.1	2.1	139.5	287	345	3400	4000	N2315Q1		
	160	55	2.1	2.1	95.5	287	345	3400	4000	NJ2315M		
160	55	2.1	2.1	95.5	287	345	3400	4000	NU2315M			
190	45	3	3	104.5	300	325	3400	5300	NJ415M			
190	45	3	3	104.5	300	325	3400	5300	NJ415M/YA8			
190	45	3	3	160.5	300	325	3400	4000	N415M			
190	45	3	3	104.5	300	325	3400	4000	NU415M			

Abutment and fillet dimensions						Weight	Model	Weight	Separate thrust collar		
d _{amin}	d _{amax}	d _{bmin}	D _{amax}	D _{amin}	r _{amax}				r _{bmax}	A1	A2
mm	kg						kg	mm			
83		97	122		1.5	1.5	1.54				
83	86	91	122		1.5	1.5	1.75				
83	86		122	121	1.5	1.5	1.77				
83		97	122		1.5	1.5	1.83				
81.5	92	91	123.5		1	1	2.27				
81.5	92	91	123.5		1	1	2.27				
86	137	107	149	142	2	2	3.75				
86	140		149	146	2	2	3.65				
86	92		149		2	2	3.28				
86	92	97	149		2	2	3.62				
86	92	97	149		2	2	3.68				
86	140		149	146	2	2	3.59				
86	92	97	149		2	2	3.25				
86	92	97	149		2	2	3.59				
86		107	149		2	2	3.75				
86	140		149	146	2	2	3.59				
86	92	97	149		2	2	3.56				
86	92	97	149		2	2	3.56				
86	92	107	149		2	2	3.63				
86	92	107	149		2	3	4.62				
86	157	107	149	163	2	2	3.64				
86	136		149	143	2	2	5.30				
86	136		149	143	2	2	5.84				
86	91	107	149		2	2	5.86	HJ2315	0.512	11 21.8 2.1	
86	91	98	149		2	2	5.96	HJ2315	0.512	11 21.8 2.1	
88	87	119	177		2.5	2.5	7.14				
88	87	119	177		2.5	2.5	7.20				
88	101		177		2.5	2.5	6.86				
88	101	107	177		2.5	2.5	6.94				

Single-row Cylindrical Roller Bearing

d 80 mm

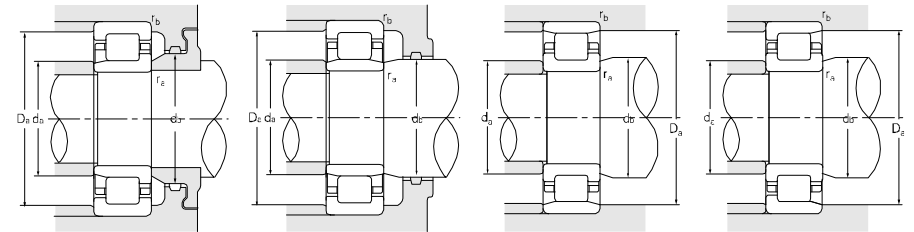
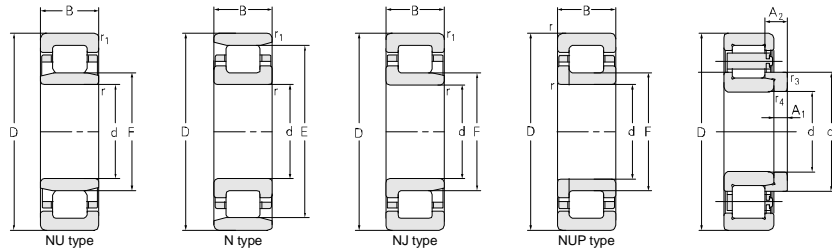

Principal dimensions						Basic load ratings		Limit speed ratings		Designations	
d	D	B	r _{1smin}	r _{smin}	F	E	C _r	C _{0r}	Grease		Oil
mm						kN		r/min			
80	140	26		2	95	127	154	4000	4800	NUP216M	
	140	26	2	2	95.3	151	184	4000	4800	NU216E	
	140	26	2	2	95.3	135	170	4000	4800	NU216Q1	
	140	26	2	2	95.3	151	184	4000	4800	NU216ETN1/C9	
	140	26	2	2	95.3	151	184	4000	4800	NUP216E	
	140	26	2	2	95.3	127.3	151	184	4000	4800	N216E
	140	26	2	2	95.3	151	184	4000	4800	NJ216E	
	140	26	2	2	95.3	160	184	4000	4800	NUP216ENR/J/C3YA6	
	140	26	2	2	95.3	160	184	4000	4800	NUP216ENRM/YA6	
	140	26	2	2	95	120	144	4000	4800	NU216M-DT	
	140	33	2	2	59.3	152	195	4000	4800	NU2216M	
	140	33	2	2	95.3	152	226	4000	4800	NJ2216M	
	140	33	2	2	95.3	204	235	4000	4800	NU2216EM	
	140	33	2	2	95.3	204	235	4000	4800	NJ2216E	
	140	33	2	2	95.3	204	235	4000	4800	NU2216E	
	140	33	2	2	95.3	127.3	204	235	4000	4800	N2216E
	140	33	2	2	95.3	204	235	4000	4800	NUP2216E	
	140	44.5	2	2	95.28	220	305	4000	4800	NU5216	
	140	44.5	2	2	95.28	210	290	4000	4800	NU3216X2M/C9YA6	
	150	45	2	2	97	245	320	3800	4500	NJ3216X3M/P54	
	150	45	2	2	97	245	320	3800	4500	NJP3216X3M/P54	
	170	39	2.1	2.1		151	217	246	3200	3800	N316M
	170	39	2.1	2.1		151	217	246	3200	3800	NF316M
	170	39	2.1	2.1	103	217	246	3200	3800	NU316M	
	170	39	2.1	2.1	103	217	246	3200	3800	NU316Q1	
	170	39	2.1	2.1	103	217	246	3200	3800	NJ316M	
	170	39	2.1	2.1	103	217	246	3200	3800	NUP316M	
	170	39	2.1	2.1	101	288	278	3200	3800	NJ316EM	
	170	39	2.1	2.1	151	288	278	3200	3800	N316EM	
	170	39	2.1	2.1	101	288	278	3200	3800	NU316EM	
	170	39	2.1	2.1	101	288	278	3200	3800	NU316EF1/C9	
	170	39	2.1	2.1	151	288	278	3200	3800	N316E	
	170	39	2.1	2.1	101	288	278	3200	3800	NJ316E	
	170	39	2.1	2.1	101	288	278	3200	3800	NU316E	
	170	39	2.1	2.1	101	288	278	3200	3800	NU316ETN1	
	170	58	2.1	2.1	147	305	380	3200	3800	N2316M	

Abutment and fillet dimensions						Weight	Model	Weight	Separate thrust collar		
d _{amin}	d _{amax}	d _{bmin}	D _{amax}	D _{amin}	r _{amax}				r _{bmax}	A1	A2
mm						kg	kg	mm			
89			104	131		2	2	1.77			
89	93		98	131		2	2	1.65			
89	93		98	131		2	2	1.74			
89	93		98	131		2	2	1.48			
89			104	131		2	2	1.72			
89	125		104	131	130	2	2	1.67			
89	93		104	131		2	2	1.68			
89			104	131		2	2	1.66			
89			104	131		2	2	1.81			
89	93		98	131		2	2	1.65			
89	93		98	131		2	2	2.32			
89	93		104	131		2	2	2.35			
89	93		98	131		2	2	2.39			
89	93		104	131		2	2	2.34			
89	93		98	131		2	2	2.30			
89	124		104	131	130	2	2	2.16			
89			104	131		2	2	2.13			
88	93		97	132		1.5	1.5	3.03			
88	93		97	132		1.5	1.5	3.03			
90	94		104	136		2	2	3.69			
90	94		104	136		2	2	3.69			
91	144		159			2	2	4.30			
91	144		159			2	2	4.46			
91	100	106	159	150		2	2	4.37			
91	100	106	159			2	2	4.45			
91	98	113	159			2	2	4.47			
91		113	159			2	2	4.58			
91	98	113	159			2	2	4.32			
91	148		159	154		2	2	4.22			
91	98	104	159			2	2	4.26			
91	98	104	159			2	2	4.20			
91	148		159	154		2	2	3.98			
91	98	113	159	154		2	2	4.08			
91	98	104	159			2	2	4.25			
91	98	104	159			2	2	3.89			
91	144		159			2	2	6.15			

Single-row Cylindrical Roller Bearing

d 80-85 mm

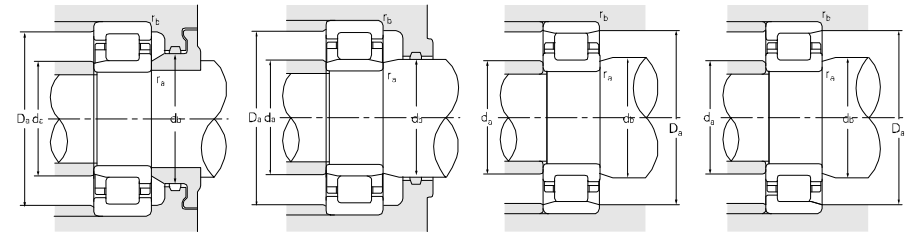
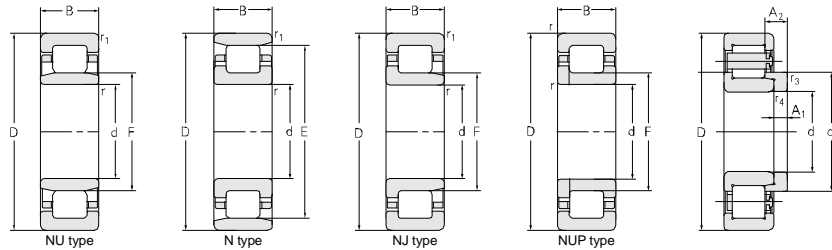

Principal dimensions						Basic load ratings		Limit speed ratings		Designations	
d	D	B	r _{1smin}	r _{smin}	F E	C _r	C _{0r}	Grease	Oil		
mm						kN		r/min			
80	170	58	2.1	2.1	103	305	380	3200	3800	NU2316M	
	170	58	2.1	2.1	103	305	380	3200	3800	NJ2316M	
	170	58	2.1	2.1	103	305	380	3200	3800	NJ2316TN1	
	170	60	2.1	2.1	100	430	545	3200	3800	NUP2316WB1V	
	170	58	2.1	2.1	101	400	422	3200	3800	NU2316E	
	170	58	2.1	2.1	101	400	422	3200	3800	N2316E	
	170	58	2.1	2.1	101	400	422	3200	3800	NJ2316E	
	170	58	2.1	2.1	101	400	422	3200	3800	NJ2316EM	
	170	58	2.1	2.1	100	305	380	3200	3800	NUP2316M/YAB	
	170	62	2.1	2.1	98	305	380	3200	3800	NUP2316X2V	
	200	48	3	3	110	341	375	3200	3800	N416M	
	200	48	3	3	110	341	375	3200	3800	NU416M	
	200	48	3	3	110	341	375	3200	3800	NJ416M	
	200	48	3	3	110	341	375	3200	3800	NJ416M/YA8	
	85	130	22	1.1	1.1	96.5	89	109	5000	6000	NJ1017TN1/C9YA6
		150	28	2	2	101.8	143	175	3800	4500	N217M
150		28	2	2	101.8	143	175	3800	4500	NU217M	
150		28	2	2	101.8	143	175	3800	4500	NU217M/W124	
150		28	2	2	101.8	143	175	3800	4500	NJ217M	
150		28	2	2	100.5	183	215	3800	4500	N217E	
150		28	2	2	100.5	183	215	3800	4500	NU217E	
150		28	2	2	100.5	183	215	3800	4500	NJ217E	
150		28	2	2	101.8	195	265	3800	4500	NUP217EM	
150		36	2	2	100.5	240	270	3800	4500	NU2217M/C3	
150		36	2	2	100.5	240	270	3800	4500	NU2217EM	
150		36	2	2	100.5	240	270	3800	4500	NU2217ETN1/C9	
150		36	2	2	100.5	240	270	3800	4500	NJ2217EM	
150		49.2	2	2	102	223	310	3800	4500	NU3217M/C3	
150		49.21	2	2	102	252	350	3800	4500	NU5217XPC3	
150		49.21	2	2	102	240	330	3800	4500	NU3217X2M/C9YA6	
180		41	3	3	108	325	330	3000	3600	N317EQ1	
180		41	3	3	108	325	330	3000	3600	NJ317EQ1	
180		41	3	3	108	325	330	3000	3600	NU317E	
180		41	3	3	108	325	330	3000	3600	NU317EM	
180	41	3	3	108	325	330	3000	3600	NU317ETN1		

Abutment and fillet dimensions						Weight	Model	Weight	Separate thrust collar		
d _{amin}	d _{amax}	d _{bmin}	D _{amax}	D _{amin}	r _{amax}				r _{bmax}	A1	A2
mm						kg	kg	mm			
91	98	106	159	154	2	2	6.34				
91	98	113	159		2	2	6.44				
91	98	113	159		2	2	5.68				
91	98	104	159		2	2	6.51				
91	98	104	159		2	2	6.28				
91	148	159	150	150	2	2	6.26				
91	98	113	159		2	2	6.94				
91	98	113	159		2	2	6.62				
91	98	118	159		2	2	7.23				
91	97	118	159		2	2	7.19				
93	167	187			2.5	2.5	8.02				
93	106	113	187		2.5	2.5	8.19	HJ416	0.37	13 21.78 3	
93	106	125	187		2.5	2.5	8.31	HJ416	0.37	13 21.78 3	
93	106	125	187		2.5	2.5	8.27	HJ416	0.37	13 21.78 3	
90	95	99	122		1	1	0.972				
94	132	141		139	2	2	2.08				
94	98	103	141		2	2	2.09				
94	98	103	141		2	2	2.09				
94	98	110	141		2	2	2.15				
94	134	141		139	2	2	2.08				
94	98	103	141		2	2	2.08				
94	98	110	141		2	2	2.12				
94	98	110	141		2	2	2.27				
94	98	103	141		2	2	2.8				
94	98	103	141		2	2	2.82				
94	98	103	141		2	2	2.42				
94	98	110	141		2	2	2.86				
94	98	103	141		2	2	3.88				
94	100	104	141		1.5	1.5	3.88				
94	100	104	141		1.5	1.5	3.88				
98	157	167		163	2.5	2.5	5.20				
98	105	120	167		2.5	2.5	5.27				
98	105	111	167		2.5	2.5	5.12				
98	105	111	167		2.5	2.5	5.16				
98	105	111	167		2.5	2.5	4.57				

Single-row Cylindrical Roller Bearing

d 85-90 mm

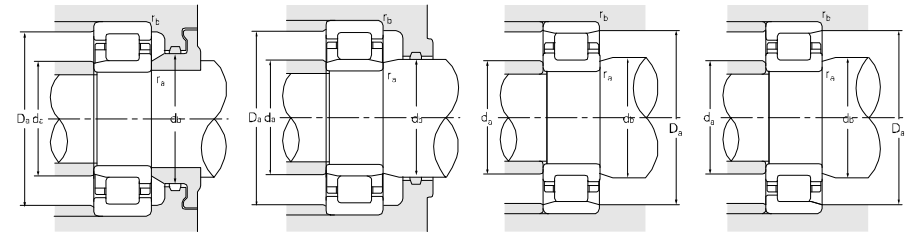
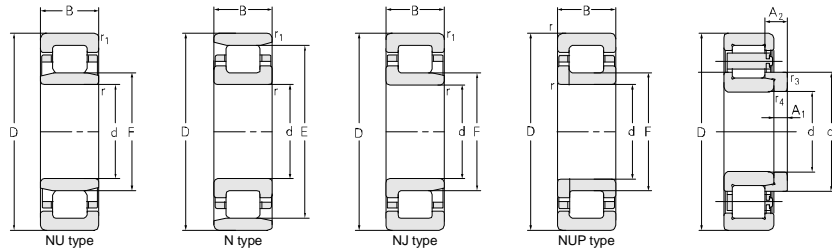

Principal dimensions						Basic load ratings		Limit speed ratings		Designations		
d	D	B	r _{1smin}	r _{smin}	F	E	C _r	C _{0r}	Grease		Oil	
mm						kN		r/min				
85	180	41	3	3	108		325	330	3000	3600	NU317EQ1	
	180	41	3	3		160	325	330	3000	3600	N317E	
	180	41	3	3		160	300	330	3000	3600	N317E/YA1	
	180	41	3	3		160	325	330	3000	3600	N317EM	
	180	41	3	3		160	325	330	3000	3600	N317EN1T	
	180	41	3	3	108		325	330	3000	3600	NJ317E	
	180	41	1.1	1.1	108		325	330	3000	3600	NJ317EM	
	180	60	3	3	108		347	435	3000	3600	NU2317M	
	180	60	3	3	108		347	435	3000	3600	NJ2317M	
	180	60	3	3		160	435	470	3000	3600	N2317E	
	180	60	3	3	108		435	470	3000	3600	NU2317E	
	180	60	3	3	108		435	470	3000	3600	NJ2317E	
	210	52	4	4		179.5	385	425	3000	3600	N417M	
	210	52	4	4	115.5		385	425	3000	3600	NU417M	
	210	52	4	4	115.5		385	425	3000	3600	NJ417M	
	210	52	4	4	115.5		385	425	3000	3600	NUP417M	
	90	140	24	1.5	1.1	103		90	115	3600	4300	NJ1018M
		140	24	1.5	1.1	103		90	115	3600	4300	NUP1018M
140		24	1.5	1.1	103		90	115	3600	4300	NU1018M	
160		30	2	2		143	165	195	3600	4300	N218J	
160		30	2	2		143	165	195	3600	4300	N218J1	
160		30	2	2		143	170	205	3600	4300	NF218M	
160		30	2	2		143	170	205	3600	4300	N218M	
160		30	2	2	107		170	205	3600	4300	NU218M	
160		30	2	2	107		170	205	3600	4300	NU218M/W124	
160		30	2	2	107		170	205	3600	4300	NJ218M	
160		30	2	2		145	200	215	3600	4300	NF218E	
160		30	2	2		145	200	215	3600	4300	N218E	
160		30	2	2	107		200	215	3600	4300	NU218ETN1/C9	
160		30	2	2	107		200	215	3600	4300	NU218E	
160		30	2	2	107		200	215	3600	4300	NJ218E	
160		30	2	2	107		165	195	3600	4300	NU218M-DT	
160		30	2	2	107		165	195	3600	4300	NUP218M	
160		40	2	2	143		215	285	3600	4300	N2218M	
160		40	2	2	107		270	300	3600	4300	NUP2218EM	

Abutment and fillet dimensions							Weight	Model	Weight	Separate thrust collar		
d _{amin}	d _{amax}	d _{bmin}	D _{amax}	D _{amin}	r _{amax}	r _{bmax}				A1	A2	r _{3,4}
mm							kg	kg	mm			
98	105	111	167		2.5	2.5	5.18					
98	157		167	163	2.5	2.5	5.14					
98	157		167	163	2.5	2.5	5.13					
98	157		167	163	2.5	2.5	5.20					
98	157		167	163	2.5	2.5	4.59					
98	105	120	167		2.5	2.5	5.21					
98	105	111	167		2.5	2.5	5.27					
96	103	111	169		2.5	2.5	7.36	HJ2317	0.617	12	23.73	3
96	103	120	169		2.5	2.5	7.81	HJ2317	0.617	12	23.73	3
96	157		169		2.5	2.5	7.44					
96	104	111	169		2.5	2.5	7.40					
96	104	120	169	163	2.5	2.5	7.57					
101	176		194	183	3	3	9.48					
101	112	119	194		3	3	9.66	HJ417	0.4	14	23.73	4
101	109	129	194		3	3	9.83	HJ417	0.4	14	23.73	4
101		129	194		3	3	10.1					
96.5	101	106	132		1.5	1	1.38					
96.5		106	132		1.5	1	1.4					
96.5	99	106	132		1.5	1	1.34					
99	140		151	148	2	2	2.37					
99	140		151	148	2	2	2.47					
99			151	148	2	2	2.71					
99	140		151	148	2	2	2.64					
99	104	110	151		2	2	2.66					
99	104	110	151		2	2	2.66					
99	104	117	151		2	2	2.72					
99			151	148	2	2	2.55					
99	142		151	148	2	2	2.49					
99	104	110	151		2	2	2.26					
99	104	110	151		2	2	2.49					
99	104	117	151		2	2	2.54					
99	104	110	151		2	2	2.57					
99		110	151		2	2	2.81					
99	105		158	151	2	2	3.62					
99		117	151		2	2	3.68					

Single-row Cylindrical Roller Bearing

d 90-95 mm

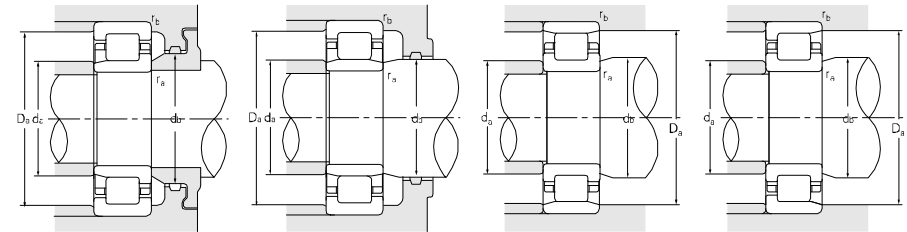
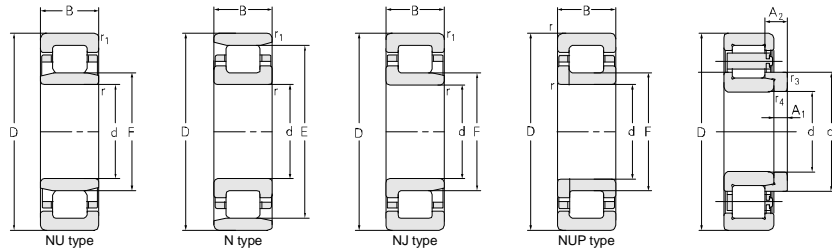

Principal dimensions						Basic load ratings		Limit speed ratings		Designations	
d	D	B	r _{1smin}	r _{smin}	F	E	C _r	C _{0r}	Grease		Oil
mm						kN		r/min			
90	160	40	2	2	107		270	300	2800	3400	NU2218ETN1
	160	40		2	107		270	300	2800	3400	NUP2218F2-ZZ/C9S2YAD
	160	40		2	107		270	300	2800	3400	NUP2218EM
	160	52.4	2	2	107.218		280	390	3600	4300	NU3218A
	160	52.4	2	2	107.218		280	390	3200	3800	NU5218XPC3
	160	52.4	2	2	107.218		280	390	3200	3800	NU5218/C9YA6
	160	52.4	2	2	107.218		280	390	3600	4300	NU3218M/C9YA6
	190	43	3			165	274	295	2800	3400	NF318
	190	43	3			165	274	315	2800	3400	NF318M
	190	43	3			165	274	315	2800	3400	N318M
	190	43	3	3	115		274	315	2800	3400	NU318M
	190	43	3	3	115		274	315	2800	3400	NU318Q1
	190	43	3	3	115		274	315	2800	3400	NJ318M
	190	43	3	3	115		274	315	2800	3400	NUP318M
	190	43	3	3	113.5		274	315	2700	3300	NJ318M/C4YA8
	190	43	3			169.5	350	345	2800	3400	N318EM
	190	43	3	3	113.5		350	345	2800	3400	NU318EM
	190	43	3	3	113.5		350	345	2800	3400	NU318ETN1
	190	43	3			169.5	350	345	2800	3400	N318E
	190	43	3	3	113.5		350	345	2800	3400	NJ318E
	190	43	3	3	113.5		350	345	2800	3400	NUP318E
	190	43	3	3	113.5		350	345	2800	3400	NU318E
	190	43	3	3	113.5		350	345	2800	3400	NH318EQ1/YB2
	190	64	3	3	115		400	505	2800	3400	NJ2318M/C4
	190	64	3	3	115		400	505	2800	3400	NUP2318M
	190	64	3	3	113.5		480	520	2800	3400	NJ2318E
	190	64	3	3	113.5		480	520	2800	3400	NU2318E
	225	54	4	4		191.5	430	480	2800	3400	N418M
225	54	4	4	123.5		430	480	2800	3400	NU418M	
225	54	4	4	123.5		430	480	2800	3400	NJ418M/C5	
95	145	24	1.5	1.1	108		115	165	4500	5300	NJ1019M
	170	32	2.1	2.1		151.5	190	230	3400	4000	N219M
	170	32	2.1	2.1	113.5		190	230	3400	4000	NU219M
	170	32	2.1	2.1	113.5		190	230	3400	4000	NU219M/W124
	170	32	2.1	2.1	113.5		190	230	3400	4000	NJ219M

Abutment and fillet dimensions						Weight	Model	Weight	Separate thrust collar		
d _{amin}	d _{amax}	d _{bmin}	D _{amax}	D _{amin}	r _{amax}				r _{bmax}	A1	A2
mm						kg	kg	mm			
100	105	110	150		2.5	2.5	3.12				
100	105	110	150		2.5	2.5	3.45				
104		117	149		2	2	3.59				
99	104	110	151		2	2	4.50				
95	105	110	151		1.5	1.5	4.50				
95	105	110	151		1.5	1.5	4.50				
95	105	110	151		1.5	1.5	4.50				
103			177	168	2.5	2.5	5.78				
103			177	168	2.5	2.5	6.21				
103	162		177	168	2.5	2.5	6.05				
103	112	118	177		2.5	2.5	6.06				
103	112	118	177		2.5	2.5	5.88				
103	110	127	177		2.5	2.5	6.19				
103		127	177		2.5	2.5	6.33				
103	110	127	177		2.5	2.5	6.37				
103	166		177	173	2.5	2.5	5.99				
103	110	116	177		2.5	2.5	5.9				
103	110	116	177		2.5	2.5	5.36				
103	166		177	173	2.5	2.5	5.93				
103	110	127	177		2.5	2.5	6.09				
103		127	177		2.5	2.5	6.05				
103	110	116	177		2.5	2.5	5.84				
103	110	127	177		2.5	2.5	6.64				
103	110	127	177		2.5	2.5	9.29				
103	110	127	177		2.5	2.5	9.36				
103	110	127	177		2.5	2.5	8.84				
103	110	118	177		2.5	2.5	8.69				
106	188		209	195	3	3	11.3				
106	120	126	209		3	3	11.5				
106	120	140	209		3	3	11.9				
101.5	104	116	137		1.5	1	1.53				
	106	149	159	157	2	2	3.07				
	106	110	116	159		2	3.13				
	106	110	116	159		2	3.13				
	106	110	116	159		2	3.13				
	106	110	123	159		2	3.23				

Single-row Cylindrical Roller Bearing

d 95 mm

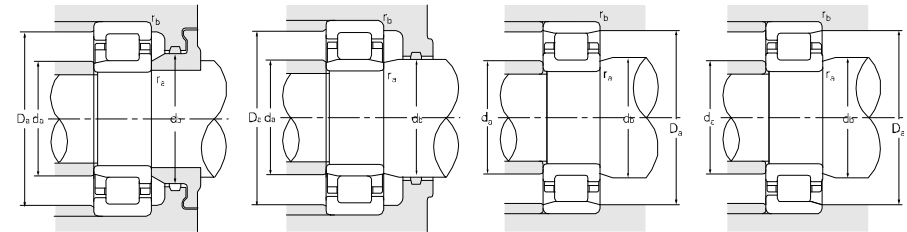
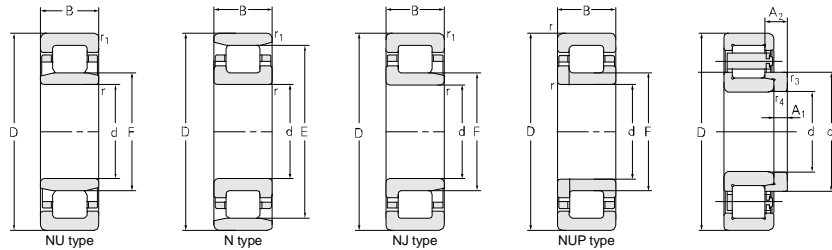

Principal dimensions						Basic load ratings		Limit speed ratings		Designations	
d	D	B	r _{1smin}	r _{smin}	F	E	C _r	C _{0r}	Grease		Oil
mm						kN		r/min			
95	170	32	2.1	2.1		154.5	245	255	3400	4000	N219EJ
	170	32	2.1	2.1		154.5	245	255	3400	4000	N219E
	170	32	2.1	2.1	112.5		245	255	3400	4000	NU219E
	170	32	2.1	2.1	112.5		245	255	3400	4000	NU219ETN1/C9
	170	32	2.1	2.1	112.5		245	255	3400	4000	NJ219E
	170	32	2.1	2.1	112.5		245	255	3400	4000	NJ219EM
	170	32	2.1	2.1	112.5		245	255	3400	4000	NJ219ETN1
	170	32	2.1	2.1		154.5	245	255	3400	4000	N219EM
	170	32	2.1	2.1		154.5	245	255	3400	4000	NF219EM
	170	43	2.1	2.1		151.5	242	315	3400	4000	N2219M
	170	43	2.1	2.1	113.5		242	315	3200	3900	NU2219M
	170	43	2.1	2.1	113.5		242	315	3200	3900	NJ2219M
	170	55.56	3.2	2		149.61	305	445	3400	4000	NU5219XPC3
	170	55.56	3.2	2		113.612	305	445	3400	4000	NU3219X2M/C9YA6
	200	45	3	3		173.5	295	340	2600	3200	N319M
	200	45	3	3		173.5	295	340	2600	3200	N319J
	200	45	3	3	121.5		295	340	2600	3200	NU319M
	200	45	3	3	121.5		295	340	2600	3200	NJ319M
	200	45	3	3	121.5		375	375	2600	3200	NU319EM/Z1
	200	45	3	3		177.5	375	375	2600	3200	N319EM
	200	45	3	3	121.5		375	375	2600	3200	NU319EM/W124
	200	45	3	3		177.5	375	375	2600	3200	N319E
	200	45	3	3		177.5	375	375	2600	3200	N319ETN1
	200	45	3	3	121.5		375	375	2600	3200	NJ319E
	200	45	3	3	121.5		375	375	2600	3200	NU319E
	200	45	3	3	121.5		375	375	2600	3200	NU319EM-DT
	200	67	3	3	121.5		435	565	2600	3200	NU2319Q1
	200	67	3	3	121.5		435	565	2600	3200	NU2319M
	200	67	3	3	121.5		435	565	2600	3200	NJ2319M
	200	67	3	3	121.5		435	565	2600	3200	NJ2319M/YA8
	200	67	3	3	121.5		435	565	2600	3200	NJ2319M/C4W124YA8
	200	67	3	3	121.5		435	565	2600	3200	NJ2319M/W20
200	67	3	3	121.5		510	560	2600	3200	NU2319E	
200	67	3	3	121.5		510	560	2600	3200	NU2319ETN1/C9	
200	67	3	3	121.5		510	560	2600	3200	NJ2319E	

Abutment and fillet dimensions							Weight	Model	Weight	Separate thrust collar		
d _{amin}	d _{amax}	d _{bmin}	D _{amax}	D _{amin}	r _{amax}	r _{bmax}				A1	A2	r _{3,4}
mm							kg	kg	mm			
106	152		159	157	2	2	2.91					
106	152		159	157	2	2	3.07					
106	110	115	159		2	2	3.06					
106	110	115	159		2	2	2.80					
106	110	123	159		2	2	3.12					
106	110	123	159		2	2	3.24					
106	110	123	159		2	2	2.86					
106	152		159	157	2	2	3.19					
106	152		159	157	2	2	3.23					
106	152		159	157	2	2	4.27					
107	110	115	158		2	2	4.31					
107	110	115	158		2	2	4.39					
107.5	112	116	161		1.5	3	5.48					
107.5	112	116	161		1.5	3	5.48					
108	170		187	178	2.5	2.5	6.67					
108	170		187	181	2.5	2.5	6.74					
108	118	124	187		2.5	2.5	7.00					
108	118	133	187		2.5	2.5	7.06					
108	118	124	187		2.5	2.5	6.68					
108	174		187	181	2.5	2.5	7.00					
108	118	124	187		2.5	2.5	6.68					
108	174		187	181	2.5	2.5	6.92					
108	174		187	181	2.5	2.5	6.31					
108	118	135	187		2.5	2.5	6.86					
108	118	124	187		2.5	2.5	6.74					
108	118	124	187		2.5	2.5	6.73					
108	116	124	187		2.5	2.5	9.86	HJ2319	0.864	13	26.23 3	
108	116	124	187		2.5	2.5	10.3	HJ2319	0.864	13	26.23 3	
108	116	135	187		2.5	2.5	10.2	HJ2319	0.864	13	26.23 3	
108	116	135	187		2.5	2.5	10.1	HJ2319	0.864	13	26.23 3	
108	116	135	187		2.5	2.5	10.1	HJ2319	0.864	13	26.23 3	
108	116	135	187		2.5	2.5	10.2	HJ2319	0.864	13	26.23 3	
108	116	124	187		2.5	2.5	9.84					
108	116	124	187		2.5	2.5	9.40					
108	116	135	187		2.5	2.5	9.77					

Single-row Cylindrical Roller Bearing

d 95-100 mm

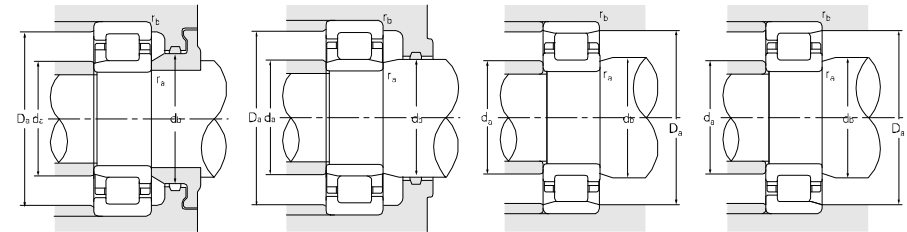
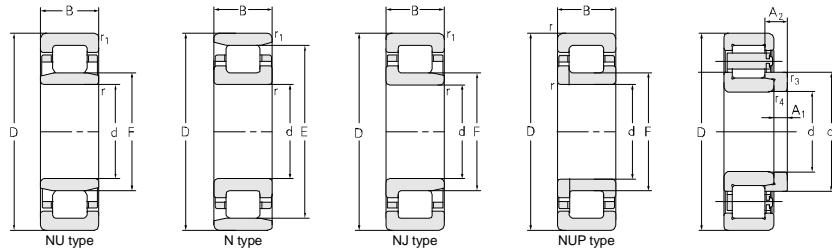

	Principal dimensions						Basic load ratings		Limit speed ratings		Designations
	d	D	B	r _{1smin}	r _{smin}	F	E	C _r	C _{0r}	Grease	
	mm						kN		r/min		
95	200	67	3	3		177.5	510	560	2600	3200	N2319E
	240	55	4	4		201.5	455	525	2600	3200	N419M
	240	55	4	4	133.5		455	525	2600	3200	NU419M
	240	55	4	4	133.5		455	525	2600	3200	NJ419M
	240	55	4	4	133.5		455	525	2600	3200	NUP419M
99.5	180	46	2.1	2.1	120		275	385	3200	3800	NJ2220X4M/P63
100	140	20	1.1	1.1	110		75.5	110	3600	4300	NU1920M
	150	24	1.5	1.1	113		94.5	125	3600	4300	NJ1020M
	180	34	2.1	2.1		160	208	256	3200	3800	N220M
	180	34	2.1	2.1		160	208	256	3200	3800	NF220M
	180	34	2.1	2.1	120		208	256	3200	3800	NJ220M
	180	34	2.1	2.1	120		208	256	3200	3800	NU220M
	180	34	2.1	2.1	120		208	256	3200	3800	NU220M/W124
	180	34	2.1	2.1	120		208	256	3200	3800	NU220Q1
	180	34	2.1	2.1		163	275	330	3200	3800	N220E
	180	34	2.1	2.1		163	275	330	3200	3800	N220ETN1
	180	34	2.1	2.1	119		275	330	3200	3800	NU220E
	180	34	2.1	2.1	119		275	330	3200	3800	NU220ETN1
	180	34	2.1	2.1	119		275	330	3200	3800	NU220ETN1/C9
	180	34	2.1	2.1	119		275	330	3200	3800	NJ220E
	180	34	2.1	2.1	119		275	330	3200	3800	NJ220ETN1
	180	34		2.1	119		275	330	3200	3800	NUP220E
	180	34		2.1	119		275	330	3200	3800	NUP220ETN1
	180	34		2.1	120		231	240	3200	3800	NUP220M
	180	34	2.1	2.1	120		195	240	3200	3800	NU220M-DT
	180	46	2.1	2.1		160	275	385	3200	3800	N2220M
	180	46		2.1	120		275	385	3200	3800	NUP2220M
	180	46	2.1	2.1	120		275	385	3200	3800	NJP2220M/P63
	180	46	2.1	2.1	120		275	385	3200	3800	NJ2220M
180	46	2.1	2.1	120		275	385	3200	3800	NU2220M	
180	46	2.1	2.1	119		365	470	3200	3800	NU2220E	
180	46	2.1	2.1	119		365	470	3200	3800	NU2220ETN1	
180	60.3	2.1	2.1	120		208	256	3200	3800	NU3220M/C3	
180	60.3	2.1	2.1	119		335	440	3200	3800	NJP3220TN1/HG2P54	

Abutment and fillet dimensions							Weight	Model	Weight	Separate thrust collar		
d _{amin}	d _{amax}	d _{bmin}	D _{amax}	D _{amin}	r _{amax}	r _{bmax}				A1	A2	r _{3,4}
mm							kg	kg	mm			
108	116		187	181	2.5	2.5	9.76					
111	198		224	205	3	3	13.3					
111	130	136	224		3	3	13.6	HJ419	1.35	15	25.23 4	
111	130	150	224		3	3	13.9	HJ419	1.35	15	25.23 4	
111		150	224		3	3	14.2					
111	116	130	169		2	2	5.42					
102	107	118	133		1	1	0.900					
105	110	123	132		1	1	1.51					
111	157		169	163	2	2	3.45					
111			169	163	2	2	3.55					
111	116	130	169		2	2	3.61					
111	116	123	169		2	2	3.52					
111	116	123	169		2	2	3.52					
111	116	123	169		2	2	3.57					
111	160		169	166	2	2	3.77					
111	160		169	166	2	2	3.75					
111	116	122	169		2	2	3.75					
111	116	122	169		2	2	3.39					
111	116	122	169		2	2	3.39					
111	116	130	169		2	2	3.81					
111	116	130	169		2	2	3.45					
111		130	169		2	2	3.90					
111		130	169		2	2	3.54					
112		130	168		2	2	3.71					
111	116	123	169		2	2	3.03					
111	116		169	166	2	2	5.25					
111	116	130	169		2	2	5.49					
111	116	130	169		2	2	5.38					
111	116	130	169		2	2	5.86					
111	116	122	169		2	2	5.20					
111	116	122	169		2	2	5.08					
111	116	122	169		2	2	4.69					
121	140	147	244		3	3	6.81					
121	140	147	244		3	3	5.98					

Single-row Cylindrical Roller Bearing

d 100 mm

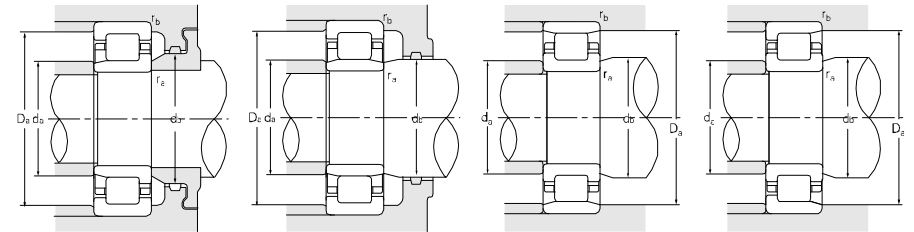
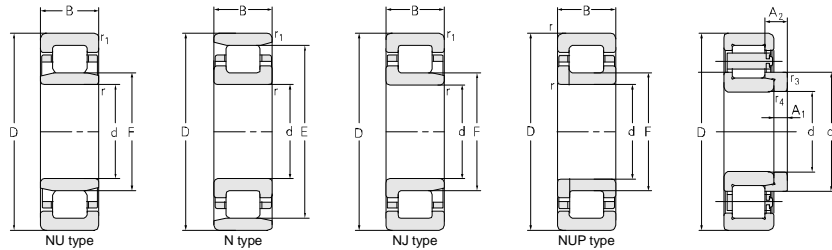

Principal dimensions						Basic load ratings		Limit speed ratings		Designations	
d	D	B	r _{1smin}	r _{smin}	F	E	C _r	C _{Or}	Grease		Oil
mm						kN		r/min			
100	180	60.3	2.1	2.1	120.8		335	440	3200	3800	NU3220Q1/P691YAD-XD
	180	60.3	3*45*	2.1	120		208	256	3200	3800	NU3220M/P59YAD
	180	60.32	4	2.1	121.005		358	515	3200	3800	NU5220XPC3
	180	60.32	4	2.1	121.005		345	495	3200	3800	NU3220X2M/C9YA6
	215	47	3	3	127.5		390	440	2400	3000	NJ320EM
	215	47	3	3	129.5		335	400	2400	3000	NU320Q1
	215	47	3	3	129.5		335	400	2400	3000	NH320M
	215	47	3	3	129.5		335	400	2400	3000	NUP320M
	215	47	3	3	129.5		335	400	2400	3000	NU320M-DT
	215	47	3.6	4	130.19		350	420	2400	3000	A-0320-22
	215	47	3	3	128.925		390	410	2400	3000	NH320EQ1/HAYB2
	215	47	3	3	127.5		390	410	2400	3000	NJ320EQ1/HA
	215	47	3	3		191.5	430	465	2400	3000	N320E
	215	47	3	3		191.5	430	465	2400	3000	N320EM
	215	47	3	3	127.5		430	465	2400	3000	NU320E
	215	47	3	3	127.5		430	465	2400	3000	NU320EM
	215	47	3	3	127.5		430	465	2400	3000	NU320EM/W124
	215	47	3	3	127.5		430	465	2400	3000	NU320EM/C9
	215	47	3	3	127.5		430	465	2400	3000	NU320EQ1
	215	47	3	3	127.5		430	465	2400	3000	NJ320E
	215	73	3	3		185.5	480	625	2400	3000	N2320M
	215	73	3	3	129.5		480	625	2400	3000	NU2320M
	215	73	3	3	129.5		480	625	2400	3000	NJ2320M
	215	73	3	3	129.5		480	625	2400	3000	NJ2320M/YA8
	215	73	3	3	129.5		480	625	2400	3000	NJ2320M/C4W124YA8
	215	73	3	3		191.5	645	760	2400	3000	N2320E
	215	73	3	3	127.5		645	760	2400	3000	NU2320E
	215	73	3	3	127.5		645	760	2400	3000	NU2320EM/C9
	215	73	3	3	127.5		645	760	2400	3000	NU2320ETN1/C9
	215	73	3	3	127.5		645	760	2400	3000	NJ2320E
	215	73	3	3	127.5		645	760	2400	3000	NJ2320EQ1
	215	73	3	3	127.5		645	760	2400	3000	NU2320EMA
	215	82.6	3	3		185.5	560	760	2400	3000	NF3320Q1
	250	58	4	4		211	505	590	2400	3000	N420M
	250	58	4	4	139		505	590	2400	3000	NU420M
	250	58	4	4	139		505	590	2400	3000	NJ420M

Abutment and fillet dimensions						Weight	Model	Weight	Separate thrust collar		
d _{amin}	d _{amax}	d _{bmin}	D _{amax}	D _{amin}	r _{amax}				r _{bmax}	A1	A2
mm						kg	kg	mm			
121	140	147	244		3	3	7.17				
121	140	147	244		3	3	7.06				
115	119	123	170		2	2	7.69				
115	119	123	170		2	2	7.69				
113	124	142	202		2.5	2.5	9.82	HJ320E	0.888	13 20.5 3	
113	124	132	202		2.5	2.5	8.78	HJ320	0.867	13 22.5 3	
113	124	142	202		2.5	2.5	9.64				
113	124	142	202		2.5	2.5	9.05				
113	120	142	202		2.5	2.5	8.55	HJ320	0.867	13 22.5 3	
113	124	142	202		2.5	2.5	9.15				
113	124	142	202		2.5	2.5	9.69				
113	124	142	202		2.5	2.5	9.59	HJ320E	0.888	13 20.5 3	
113	188	202	202	195	2.5	2.5	8.24				
113	188	202	202	195	2.5	2.5	9.67				
113	124	130	202		2.5	2.5	8.35	HJ320E	0.888	13 20.5 3	
113	124	130	202		2.5	2.5	9.67	HJ320E	0.888	13 20.5 3	
113	124	130	202		2.5	2.5	9.67	HJ320E	0.888	13 20.5 3	
113	124	130	202		2.5	2.5	9.67	HJ320E	0.888	13 20.5 3	
113	124	130	202		2.5	2.5	9.59	HJ320E	0.888	13 20.5 3	
113	124	142	202		2.5	2.5	8.50	HJ320E	0.888	13 20.5 3	
113	182	202	202	190	2.5	2.5	13.1				
113	125	133	202		2.5	2.5	13.2	HJ2320	0.98	13 27.23 3	
113	125	142	202		2.5	2.5	13.5	HJ2320	0.98	13 27.23 3	
113	125	142	202		2.5	2.5	13.5	HJ2320	0.98	13 27.23 3	
113	125	142	202		2.5	2.5	13.5	HJ2320	0.98	13 27.23 3	
113	125	142	202		2.5	2.5	13.5	HJ2320	0.98	13 27.23 3	
113	188	202	202	195	2.5	2.5	12.9				
113	124	130	202		2.5	2.5	12.7	HJ2320E0.946		23.28 23.5 3	
113	124	130	202		2.5	2.5	13.8	HJ2320E0.946		23.28 23.5 3	
113	124	130	202		2.5	2.5	11.5	HJ2320E0.946		23.28 23.5 3	
113	124	142	202		2.5	2.5	12.9	HJ2320E0.946		23.28 23.5 3	
113	124	142	202		2.5	2.5	12.9	HJ2320E0.946		23.28 23.5 3	
113	124	130	202		2.5	2.5	13.4				
113	124	130	202	195	2.5	2.5	15.6				
116	208	234	234	215	3	3	15.4				
116	135	142	234		3	3	15.5				
116	135	156	234		3	3	15.9				

Single-row Cylindrical Roller Bearing

d 105~110 mm

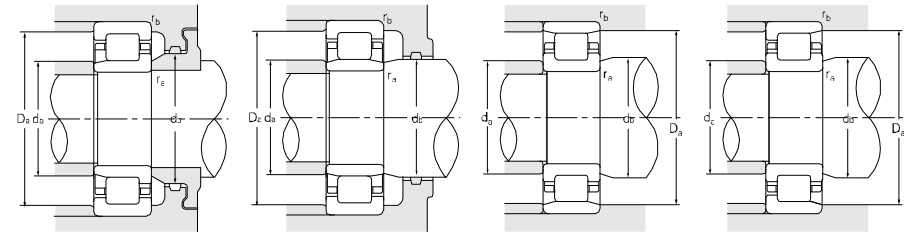
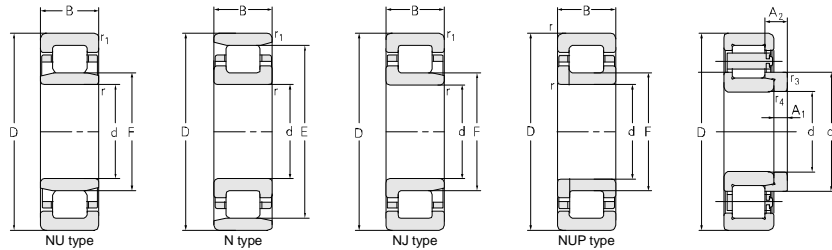

Principal dimensions						Basic load ratings		Limit speed ratings		Designations
d	D	B	r _{1smin}	r _{smin}	F	E	C _r	C _{0r}	Grease	
mm						kN		r/min		
105	160	26	2	1.1	145.5	120	170	4000	4800	NF1021M
	160	26	2	1.1	145.5	120	170	4000	4800	N1021M
	190	36	2.1	2.1	168.8	225	285	3000	3600	N221M
	190	36	2.1	2.1	126.8	225	285	3000	3600	NJ221M
	190	36	2.1	2.1	126.8	225	285	3000	3600	NU221M/W124
	190	36	2.1	2.1	125	290	315	3000	3600	NJ221EM
	190	36	2.1	2.1	125	290	315	3000	3600	NU221EM/C9
	190	36	2.1	2.1	125	290	315	3000	3600	NU221EM
	190	65.1	2.1	2.1	126.8	350	500	3000	3600	NU3221M/C3
	225	49	3	3	201	480	525	2200	2800	N321EM
	225	49	3	3	133	480	525	2200	2800	NJ321EM
	225	49	3	3	133	480	525	2200	2800	NU321EM
	225	49	3	3	133	480	525	2200	2800	NU321EM/C9
	225	87.3	3	3	196	660	910	2200	2800	N3321
	260	60	4	4	220.5	560	655	2200	2800	N421M
	260	60	4	4	144.5	560	655	2200	2800	NU421M
	260	60	4	4	144.5	560	655	2200	2800	NJ421M/C5
107.95	165.1	57.15	2.5	2.5	127	285	590	3000	3600	NA6/107X4/C9
110	170	28	2	1.1	155	140	195	3800	4500	N1022M
	170	28	2	1.1	125	140	195	3800	4500	NU1022M
	170	28	2	1.1	125	140	195	3800	4500	NJ1022M
	170	28	2	1.1	125	140	195	3800	4500	NUP1022M
	170	28	2	1.1	125	140	195	3800	4500	NUP1022TN1/C9YB2
	200	38	2.1	2.1	178.5	255	315	2800	3400	N222J
	200	38	2.1	2.1	132.5	255	315	2800	3400	NU222M/YA8
	200	38	2.1	2.1	132.5	255	315	2800	3400	NU222Q1
	200	38	2.1	2.1	178.5	255	315	2800	3400	NF222M
	200	38	2.1	2.1	178.5	270	335	2800	3400	N222M
	200	38	2.1	2.1	132.5	270	335	2800	3400	NJ222M
	200	38	2.1	2.1	132.5	270	335	2800	3400	NU222M/W124
	200	38	2.1	2.1	132.5	270	335	2800	3400	NU222M
	200	38	2.1	2.1	132.5	320	350	2800	3400	NU222EM/C9
	200	38	2.1	2.1	180.5	320	350	2800	3400	N222EM
	200	38	2.1	2.1	132.5	320	350	2800	3400	NJ222EM

Abutment and fillet dimensions							Weight	Model	Weight	Separate thrust collar		
d _{amin}	d _{amax}	d _{bmin}	D _{amax}	D _{amin}	r _{amax}	r _{bmax}				A1	A2	r _{3,4}
mm							kg	kg	mm			
111.5	141		151	149	2	1	1.93					
111.5	166		151	149	2	1	1.85					
116	121		179	172	2	2	4.33					
116	198	137	179		2	2	4.34					
116	198	137	179		2	2	4.25					
116	198	137	179		2	2	4.52					
116	198	137	179		2	2	4.42					
116	198	137	179		2	2	4.33					
116	122	128	179		2	2	8.22					
118	130		212	203	2.5	2.5	10.5					
118	130	148	212		2.5	2.5	10.7					
118	217	136	212		2.5	2.5	10.6					
118	217	136	212		2.5	2.5	10.6					
116	193		208	199	2.5	2.5	18.3					
121	151		244	224	3	3	17.2					
121	217	136	244		3	3	17.3					
121	217	136	244		3	3	17.6					
114	121	125	155		2	2	5.11					
116.5	123		161	157	2	1	2.31					
116.5	175	128	161		2	1	2.32					
116.5	175	128	161		2	1	2.39					
116		135	161		2	2	2.45					
116		135	161		2	2	2.17					
121	175		189	181	2	2	4.70					
121	129	135	189		2	2	5.30					
121	177	135	189		2	2	5.36					
121	129		189	181	2	2	5.17					
121	129		189	181	2	2	5.02					
121	129	145	189		2	2	5.10					
121	129	135	189		2	2	5.05					
121	129	135	189		2	2	5.05					
121	129		189	183	2	2	5.28					
121	129		189	183	2	2	5.27					
121	204	145	189		2	2	5.38					

Single-row Cylindrical Roller Bearing

d 110~120 mm

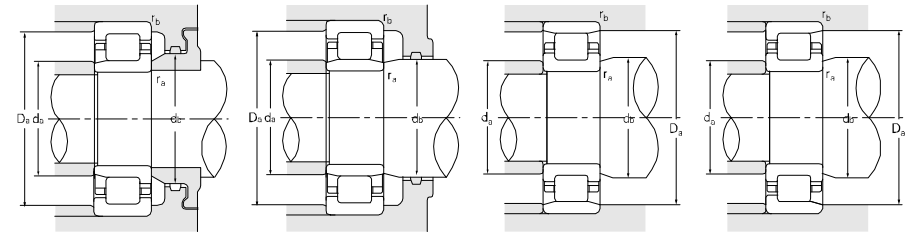
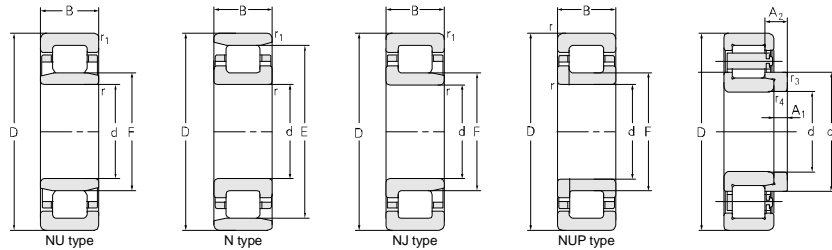

Principal dimensions						Basic load ratings		Limit speed ratings		Designations	
d	D	B	r _{1smin}	r _{smin}	F	E	C _r	C _{Or}	Grease		Oil
mm						kN		r/min			
110	200	38	2.1	2.1		180.5	320	350	2800	3400	N222E
	200	38	2.1	2.1	132.5		320	350	2800	3400	NU222E
	200	38	2.1	2.1	132.5		320	350	2800	3400	NJ222E
	200	53		2	132		352	470	2800	3400	NUP2222M
	200	53	2.1	2.1	132		352	470	2800	3400	NU2222M
	200	53	2.1	2.1	132		352	470	2800	3400	NJ2222M
	200	53	2	2	132		420	520	2800	3400	NU2222ETN1/C9
	200	69.8	2.1	2.1	132.5		450	655	2800	3400	NU3222M/C3
	240	50	3	3		207	410	480	2000	2600	N322
	240	50	3	3	143		410	480	2000	2600	NU322M-DT
	240	50	3	3		207	430	515	2000	2600	N322M
	240	50	3	3	143		430	515	2000	2600	NJ322M
	240	50	3	3	143		430	515	2000	2600	NU322M
	240	50	3	3	143		430	515	2000	2600	NU322Q1
	240	50	3	3	143		430	515	2000	2600	NUP322M
	240	50	3	3		211	510	520	2000	2600	N322EM
	240	50	3	3	143		510	520	2000	2600	NU322EM
	240	50	3	3	143		510	520	2000	2600	NU322ETN1/C9
	240	50	3	3	143		510	520	2000	2600	NU322EM/W124
	240	50	3	3		211	510	520	2000	2600	N322E
	240	50	3	3	143		510	520	2000	2600	NJ322E
	240	50	3	3	143		510	520	2000	2600	NU322E
	240	50	3	3	143		510	520	2000	2600	NU322EQ1/C9
	240	80	3	3	143		750	865	2000	2600	NU2322EQ1
	240	80	3	3	143		750	865	2000	2600	NJ2322EM/YA8
	240	80	3	3	143		750	865	2000	2600	NJ2322EM
	240	80	3	3	143		750	865	2000	2600	NU2322EM
	240	80	3	3	143		750	865	2000	2600	NU2322M/C9
	240	80	3	3	143		750	865	2000	2600	NU2322E
	240	80	3	3		211	750	865	2000	2600	N2322E
	240	80	3	3	143		750	865	2000	2600	FL-NU2322EM/P6
	280	65	4	4		235	615	725	2000	2600	N422M
280	65	4	4			615	725	2000	2600	NU422M	
280	65	4	4			615	725	2000	2600	NJ422M	
120	160	27	1.1	1.1	152	105	170	3400	4000	NF2924X1M	

Abutment and fillet dimensions							Weight	Model	Weight	Separate thrust collar		
d _{amin}	d _{amax}	d _{bmin}	D _{amax}	D _{amin}	r _{amax}	r _{bmax}				A1	A2	r _{3,4}
mm							kg	kg	mm			
121	177		189	183	2	2	5.11					
121	129	135	189		2	2	5.12					
121	204	145	189		2	2	5.02					
121		145	189		2	2	7.95					
121	129	135	189		2	2	7.63					
121	138	145	189		2	2	7.83					
121		145	189		2	2	6.57					
121	129	135	189		2	2	9.92					
123	208		227	210	2.5	2.5	10.2					
123	139	146	227		2.5	2.5	11.6	HJ322E	1.25	14	22	
123	139		227	210	2.5	2.5	11.4				3	
123	139	159	227		2.5	2.5	11.8					
123	139	146	227		2.5	2.5	11.6					
123		146	227		2.5	2.5	11.6					
123	230	159	227		2.5	2.5	10.3					
123	204		227	215	2.5	2.5	11.4					
123	139	146	227		2.5	2.5	11.5	HJ322E	1.25	14	22	
123	139	146	227		2.5	2.5	10.4	HJ322E	1.25	14	22	
123	139	146	227		2.5	2.5	11.5	HJ322E	1.25	14	22	
123	204		227	215	2.5	2.5	11.2					
123	139	159	227		2.5	2.5	11.4	HJ322E	1.25	14	22	
123	139	146	227		2.5	2.5	11.3	HJ322E	1.25	14	22	
123	139	146	227		2.5	2.5	11.8	HJ322E	1.25	14	22	
123	138	146	227		2.5	2.5	17.6	HJ2322E	1.31	14	26.22	
123	138	159	227		2.5	2.5	18.8	HJ2322E	1.31	14	26.22	
123	138	159	227		2.5	2.5	18.7	HJ2322E	1.31	14	26.22	
123	138	146	227		2.5	2.5	18.3	HJ2322E	1.31	14	26.22	
123	133	146	227		2.5	2.5	18.3	HJ2322E	1.31	14	26.22	
123	138	146	227		2.5	2.5	17.6	HJ2322E	1.31	14	26.22	
123	138		227	215	2.5	2.5	17.5					
123	138	146	227		2.5	2.5	18.6					
126	150		264	240	3	3	21.8					
126	150	158	264		3	3	22.0					
126	129	174	264		3	3	22.3					
126	130		158	150	1	1	1.74					

Single-row Cylindrical Roller Bearing

d 120 mm

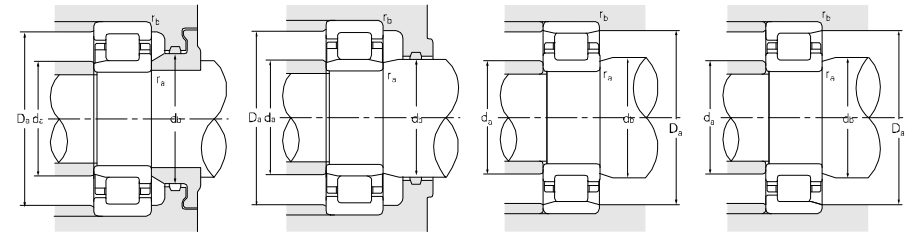
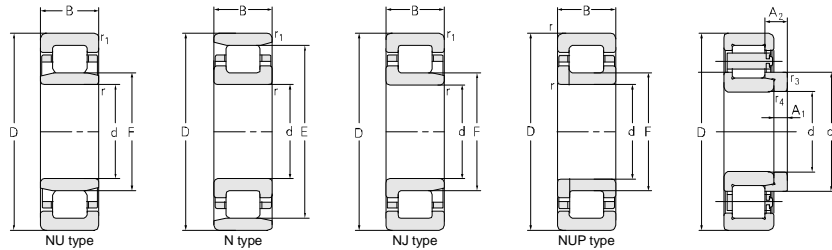

Principal dimensions						Basic load ratings		Limit speed ratings		Designations	
d	D	B	r _{1smin}	r _{smin}	F	E	C _r	C _{0r}	Grease		Oil
mm						kN		r/min			
120	180	28	2	1.1	135		145	205	3400	4000	NU1024M
	180	28	2	1.1	135		145	205	3400	4000	NU1024MA
	180	28	2	1.1	135		145	205	3400	4000	NJ1024M
	215	40	2.1	2.1	143.5		290	210	2400	3000	NU224M/P59
	215	40	2.1	2.1		191.5	305	390	2400	3000	N224M
	215	40	2.1	2.1	143.5		305	390	2400	3000	NJ224M
	215	40	2.1	2.1	143.5		305	390	2400	3000	NU224M
	215	40	2.1	2.1	143.5		305	390	2400	3000	NU224M-DT
	215	40	2.1	2.1	143.5		375	420	2400	3000	NU224EMA
	215	40	2.1	2.1		195.5	375	420	2400	3000	N224E
	215	40	2.1	2.1	143.5		375	420	2400	3000	NU224E
	215	40	2.1	2.1	143.5		375	420	2400	3000	NJ224E
	215	40	2.1	2.1	143.5		375	420	2400	3000	NJ224EM
	215	40	2.1	2.1	143.5		375	420	2400	3000	NUP224E
	215	40	2.1	2.1	143.5		375	420	2400	3000	NU224EQ1
	215	40	2.1	2.1	143.5		375	420	2400	3000	NU224EM
	215	40	2.1	2.1	143.5		375	420	2400	3000	NU224EM/W124
	215	40	2.1	2.1	143.5		375	420	2400	3000	NU224EM/C9
	215	58	2.1	2.1		191.5	395	550	2400	3000	N2224M
	215	58	2.1	2.1	143.5		395	550	2400	3000	NU2224M
	215	58	2.1	2.1	143.5		395	550	2400	3000	NJ2224M
	215	58	2.1	2.1	143.5		500	605	2400	3000	NJ2224EM
	215	58	2.1	2.1		195.5	500	605	2400	3000	NF2224EM
	215	58	2.1	2.1		195.5	500	605	2400	3000	N2224E
	215	58	2.1	2.1	143.5		500	605	2400	3000	NU2224E
	215	58	2.1	2.1	143.5		500	605	2400	3000	NU2224ETN1
	215	58	2.1	2.1	143.5		500	605	2400	3000	NU2224ETN1/C9
	215	58	2.1	2.1	143.5		500	605	2400	3000	NJ2224E
	215	76	2.1	2.1	145.14		515	780	2400	3000	NU3224M
	215	76	2.1	2.1	145.14		515	780	2400	3000	NU3224M/C4
	215	76.2	5.1	2	145.14		515	780	2200	2800	NU3224X2M/C9YA6
	215	76.2	5.1	2	145.14		550	845	2200	2800	NU5224XPC3
	240	80	3	3.7	150		530	790	2400	3200	NJ624M
	260	55	3	3		226	505	600	2400	3000	NF324M
	260	55	3	3		226	460	600	2400	3000	NF324M/YA8
	260	55	3	3		226	490	645	1900	2400	N324M

Abutment and fillet dimensions						Weight	Model	Weight	Separate thrust collar		
d _{amin}	d _{amax}	d _{bmin}	D _{amax}	D _{amin}	r _{amax}				r _{bmax}	A1	A2
mm						kg	kg	mm			
126.5	133	138	171		2	1	2.96				
126.5	133	138	171		2	1	2.96				
126.5	188	144	171		2	1	3.09				
131	140	146	204		2	2	6.27				
131	140		204	195			6.11				
131	140	156	204		2	2	6.39	HJ224	0.698	11 18.73 2.1	
131	192	146	204		2	2	6.27	HJ224	0.698	11 18.73 2.1	
131	192	146	204		2	2	6.19				
131	192	146	204		2	2	6.92				
131	140		204	199	2	2	6.32				
131	140		204		2	2	6.73				
131		156	204		2	2	6.67				
131		156	204		2	2	6.68				
131		156	204		2	2	6.80				
131	140	146	204		2	2	6.88				
131	140	146	204		2	2	6.74				
131	140	146	204		2	2	6.78				
131	140	146	204		2	2	6.74				
131	188		204	195	2	2	8.92				
131	139	146	204		2	2	9.31				
131	139	156	204		2	2	9.46				
131	140	156	204		2	2	9.80				
130		206		199	2	2	9.72				
131	192		204	199	2	2	9.15				
131	140	146	204		2	2	9.00				
131	140	146	204		2	2	8.33				
131	140	146	204		2	2	8.33				
131	140	156	204		2	2	9.15				
131	140	146	204		2	2	12.4				
131	140	146	204		2	2	12.4				
135.6	142	148	204		1.5	2	12.6				
135.6	142	148	204		1.5	2	12.6				
140	147	165	222		2.5	2.5	17.7				
133	222		247	230	2.5	2.5	14.3				
133	222		247	230	2.5	2.5	14.3				
133			247	230	2.5	2.5	15.1				

Single-row Cylindrical Roller Bearing

d 120~129 mm

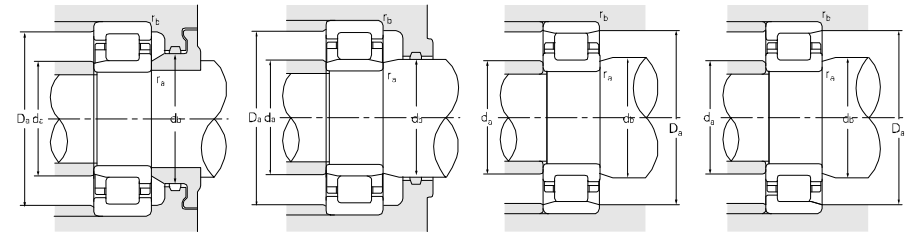
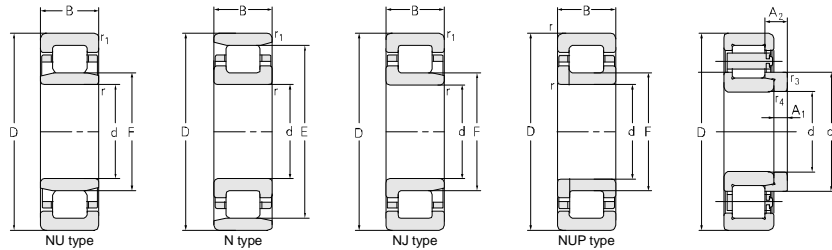

Principal dimensions						Basic load ratings		Limit speed ratings		Designations		
d	D	B	r _{1smin}	r _{smin}	F	E	C _r	C _{0r}	Grease		Oil	
mm						kN		r/min				
120	260	55	3	3			226	490	645	1900	2400	N324J
260	55	3	3	3	154		540	645	1900	2400		NU324M
260	55	3	3	3	154		540	645	1900	2400		NU324M/W124
260	55	3	3	3	154		540	645	1900	2400		NU324Q1
260	55	3	3	3	154		540	645	1900	2400		NJ324M
260	55	3	3	3	154		560	660	1900	2400		NJ324EQ1A/C9YA8
260	55	3	3	3	154		540	645	1900	2400		NUP324M
260	55	3	3	3	154		590	710	1900	2400		NU324EM
260	55	3	3	3		230	540	710	1900	2400		N324E
260	55	3	3	3	154		595	710	1900	2400		NU324E
260	55	3	3	3	154		590	710	1900	2400		NU324ETN1/C9
260	55	3	3	3	154		594	710	1900	2400		NJ324E
260	55	3	3	3	154		490	710	1900	2400		NU324M-DT/YB2
260	55	3	3	3	154		490	710	1900	2400		NU324L3-DT/YB2
260	55	3	3	3	154		490	710	1900	2400		NU324L3-DT
260	55	3	3	3	154		490	710	1900	2400		NU324M-DT
260	86	3	3	3		226	735	970	1900	2400		N2324M
260	86	3	3	3	154		735	970	1900	2400		NU2324M
260	86	3	3	3	154		780	1040	1900	2400		NJ2324M/YA8-1
260	86	3	3	3	154		735	970	1900	2400		NJ2324M
260	86	3	3	3	154		780	1040	1900	2400		NJ2324M/C4YA8
260	86	3	3	3	154		780	1040	1900	2400		NJ2324M/C4W124YA8-1
260	86	3	3	3	154		860	1040	1900	2400		FL-NJ2324EQ1A
260	86	3	3	3	154		860	1040	1900	2400		FL-NJ2324EQ1A/C3
260	104.775	3	3	3		230	910	1240	1900	2400		N3324X2M
260	106	3	3	3		230	990	1380	1900	2400		NF3324Q1
310	72	5	5	5		260	770	915	1900	2400		N424M
310	72	5	5	5	170		770	915	1900	2400		NU424M
310	72	5	5	5	170		770	915	1900	2400		NU424Q1
310	72	5	5	5	170		770	915	1900	2400		NJ424M
127	228.6	34.925	2	1.1			199.8	295	410	1900	2400	N6/127M/YAB
129	250	80	3	3.7	158		665	807	1800	2200		NJP3226X1K2
	250	80	3	3.7	158		665	807	1800	2200		NJ3226X1K2

Abutment and fillet dimensions							Weight	Model	Weight	Separate thrust collar		
d _{amin}	d _{amax}	d _{bmin}	D _{amax}	D _{amin}	r _{amax}	r _{bmax}				A1	A2	r _{3, r4}
mm							kg	kg	mm			
133	222		247	230	2.5	2.5	13.9					
133	150	157	247		2.5	2.5	15.4					
133	150	157	247		2.5	2.5	15.4					
133	150	157	247		2.5	2.5	15.2					
133	150	171	247		2.5	2.5	15.7					
133	150	171	247		2.5	2.5	15.4					
133		171	247		2.5	2.5	16.0					
133	150	157	247		2.5	2.5	16.3					
133	226		247	234	2.5	2.5	14.3					
133	150	157	247		2.5	2.5	15.8					
133	150	157	247		2.5	2.5	14.6					
133	150	171	247		2.5	2.5	16.0					
133	150	157	247		2.5	2.5	15.0					
133	150	157	247		2.5	2.5	14.3					
133	150	157	247		2.5	2.5	14.9					
133	150	157	247		2.5	2.5	15.0					
133	223		247	229	2.5	2.5	22.9					
133	149	157	247		2.5	2.5	23.1	HJ2324	1.52	14	27.72 3	
133	149	170	247		2.5	2.5	23.7	HJ2324	1.52	14	27.72 3	
133	149	170	247		2.5	2.5	23.6	HJ2324	1.52	14	27.72 3	
133	149	170	247		2.5	2.5	24.6	HJ2324	1.52	14	27.72 3	
133	149	170	247		2.5	2.5	23.7	HJ2324	1.52	14	27.72 3	
133	149	170	247		2.5	2.5	31.0					
133	149	170	247		2.5	2.5	31.0					
133	226		247	234	2.5	2.5	28.0					
133	149	170	247		2.5	2.5	29.9					
140	254		290	266	4	4	29.0					
140	165	173	290		4	4	29.1					
140	165	173	290		4	4	28.8					
140	165	191	290		4	4	29.7					
134	196		223	204	1	1	5.60					
150	170	200	230		3	3	18.6					
150	170	200	230		3	3	18.4					

Single-row Cylindrical Roller Bearing

d 129.5~130 mm

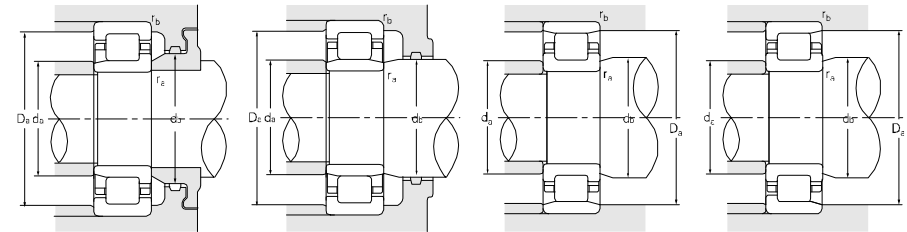
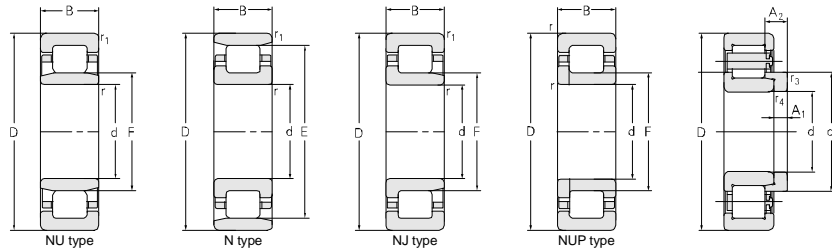

Principal dimensions						Basic load ratings		Limit speed ratings		Designations		
d	D	B	r _{1smin}	r _{smin}	F	E	C _r	C _{0r}	Grease		Oil	
mm						kN		r/min				
129.5	250	80	3	3.7	158		665	807	1800	2200	NJP3226X1K1 NJ3226X1K1	
	250	80	3	3.7	158		665	807	1800	2200		
130	180	50	1.5	1.5	150		220	555	1900	2400	NA4926/C9	
	200	33	2	1.1		182	190	274	3200	3800	N1026M	
	200	33	2	1.1	148		190	274	3200	3800	NU1026M	
	200	33	2	1.1	148		190	274	3200	3800	NJ1026M	
	200	42	2	1.1	147		280	415	3000	3700	NU2026EMA	
	220	62	2	2.1	150		528	675	2200	2800	NJP2226X3TN1/HG2	
	230	64	3	3	150		410	580	2200	2800	NJP2226Q1/C4S0	
	220	62	2	2.1	150		528	675	2200	2800	NJ2226X3TN1/HG2	
	230	40	3	3			204	301	395	2200	2800	N226J
	230	40	3	3			204	315	415	2200	2800	N226M
	230	40	3	3	156		315	415	2200	2800	NU226M	
	230	40	3	3	156		315	415	2200	2800	NU226M/W124	
	230	40	3	3	156		315	415	2200	2800	NJ226M	
	230	40	3	3	153.5		400	465	2200	2800	NU226EQ1	
	230	40	3	3	153.5		400	465	2200	2800	NU226EM/C9	
	230	40	3	3	153.5		400	465	2200	2800	NJ226EQ1	
	230	40	3	3			209.5	400	465	2200	2800	N226E
	230	40	3	3			209.5	340	420	2200	2800	NF226EM
	230	40	3	3	153.5		400	465	2200	2800	NJ226E	
	230	40	3	3	153.5		400	465	2200	2800	NJ226EM	
	230	40	3	3	153.5		400	465	2200	2800	NU226E	
	230	40	3	3	153.5		400	465	2200	2800	NUP226E	
	230	40	3	3	156		315	415	2200	2800	NU226M-DT	
	230	64	3	3			204	430	625	2200	2800	NF2226M
	230	64	3	3			204	430	625	2200	2800	N2226M
	230	64	3	3	156		430	625	2200	2800	NU2226M	
	230	64	3	3	156		430	625	2200	2800	NJ2226M	
	230	64	3	3	156		430	625	2200	2800	NJ2226Q1	
	230	64	3	3	156		430	625	2200	2800	NUP2226M	
	230	64	3	3	153.5		530	735	2200	2800	NU2226E	
	230	64	3	3	153.5		595	795	2200	2800	FL-NU2226EMA/C3	
	230	64	3	3	153.5		530	735	2200	2800	NU2226EQ1	

Abutment and fillet dimensions						Weight	Model	Weight	Separate thrust collar		
d _{amin}	d _{amax}	d _{bmin}	D _{amax}	D _{amin}	r _{amax}				r _{bmax}	A1	A2
mm						kg	kg	mm			
150	170	200	230		3	3	18.5				
150	170	200	230		3	3	18.4				
150	170	145	160		1.5	1.5	4.36				
136.5	178		191	184	2	1	4.57				
136.5	145	151	191		2	1	4.66				
136.5	145	151	191		2	1	4.61				
143	149	167	217		1	1	4.95				
143	149	167	217		2.5	2.5	8.68				
143	149	167	217		2.5	2.5	11.9				
143	149	167	217		2.5	2.5	8.69				
143	200		217	207	2.5	2.5	6.52				
143	200		217	207	2.5	2.5	7.08				
143	153	159	217		2.5	2.5	7.22				
143	153	159	217		2.5	2.5	7.54				
143	153	167	217		2.5	2.5	7.32				
143	150	156	217		2.5	2.5	7.38				
143	150	156	217		2.5	2.5	7.54				
143	150	167	217		2.5	2.5	7.50				
143	206		217	213	2.5	2.5	7.09				
143	206		217	213	2.5	2.5	7.57				
143	150	167	217		2.5	2.5	7.38				
143	150	167	217		2.5	2.5	7.66				
143	150	156	217		2.5	2.5	7.26				
143	167	217			2.5	2.5	7.49				
143	153	159	217		2.5	2.5	7.12				
143			217	209	2.5	2.5	11.7				
143	200		217	209	2.5	2.5	11.6				
143	153	159	217		2.5	2.5	11.8				
143	153	167	217		2.5	2.5	11.9				
143	153	167	217		2.5	2.5	11.9				
143	167	217			2.5	2.5	12.2				
143	149	156	217		2.5	2.5	11.5				
143	149	156	217		2.5	2.5	11.2				
143	149	156	217		2.5	2.5	11.1				

Single-row Cylindrical Roller Bearing

d 130 mm

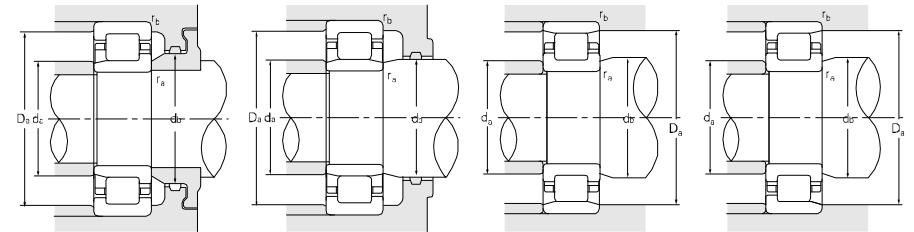
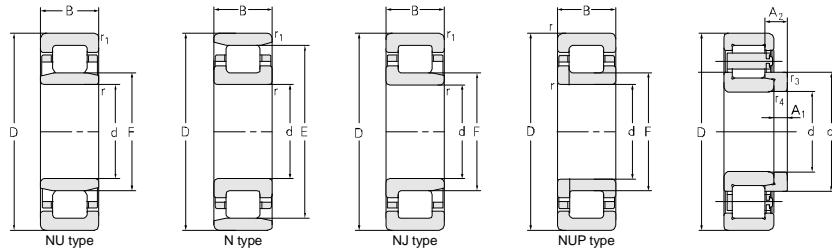

Principal dimensions						Basic load ratings		Limit speed ratings		Designations	
d	D	B	r _{1smin}	r _{smin}	F	E	C _r	C _{0r}	Grease		Oil
mm						kN		r/min			
130	230	64	3	3		204	430	625	2200	2800	N2226M/YA1
	230	64	3	3	153.5		550	780	2200	2800	NJ2226EQ1
	230	79.38	3	5.3	155		590	890	1800	2200	NU3226X2M/C9YA6
	240	80	3	3	158		655	975	1800	2200	NJ3226X1M-1
	240	85	3	3	158		655	975	1800	2200	NJP3226X1WBM-1
	240	87	3	3	156		580	800	1800	2200	NJ3226X1SCTN
	240	87	3	3	156		580	800	1800	2200	NJP3226X1SCTN
	250	80	3	3	158		665	805	1800	2200	NJP3226X1TN1
	250	80	3	3	158		665	805	1800	2200	NJ3226X1TN1
	250	80	3	3	158		605	805	1800	2200	NJ3226X1K1
	280	58	3	3	167		732	780	1800	2200	NU326Q1/HAC9YA5
	280	58	4	4		243	570	690	1800	2200	N326M
	280	58	4	4	167		570	690	1800	2200	NU326M
	280	58	4	4	167		595	795	1800	2200	NU326EM/W124
	280	58	4	4	167		570	690	1800	2200	NU326Q1
	280	58	4	4	167		570	690	1800	2200	NJ326M
	280	58	4	4	167		595	795	1800	2200	FL-NU326EMA
	280	58	4	4		247	595	795	1800	2200	N326EM
	280	58	4	4		247	595	795	1800	2200	NJ326EM
	280	58	4	4	167		595	795	1800	2200	NU326EM/W124
	280	58	4	4	167		655	795	1800	2200	NU326E
	280	58	4	4		247	655	795	1800	2200	N326E
	280	58	4	4	167		655	795	1800	2200	NJ326E
	280	93	4	4	167		870	1180	1800	2200	NU2326M
	280	93	4	4	167		870	1180	1800	2200	NJ2326M/YA8
	280	93	4	4	167		870	1180	1800	2200	NJ2326M/YA8-2
	280	93	4	4		243	870	1180	1800	2200	N326M
	280	93	4	4	167		870	1180	1800	2200	NJ2326M
	280	93	4	4	167		900	1200	1800	2200	NU2326EM/C9
	280	93	4	4	167		790	1180	1800	2200	NJ2326M/C4W124YA8-1
	280	93	4	4	167		870	1180	1800	2200	NJ2326J
	280	93	4	4	167		870	1180	1800	2200	NUP2326M
	280	93	4	4	167		780	1060	1800	2200	32626QTY
	280.01	58.001	4.318	6.477	166.848		660	795	1800	2200	A-0326-WAB-30-1
	340	78	5	5	185		941	1110	1800	2200	NU426M

Abutment and fillet dimensions							Weight	Model	Weight	Separate thrust collar		
d _{amin}	d _{amax}	d _{bmin}	D _{amax}	D _{amin}	r _{amax}	r _{bmax}				A1	A2	r _{3,4}
mm							kg	kg	mm			
143	200		217	209	2.5	2.5	11.6					
143	149	167	217		2.5	2.5	11.5					
146	240		264	246	3	3	14.6					
146	153	167	227		2.5	2.5	17.0					
146	153	167	227		2.5	2.5	17.3					
146	153	167	227		2.5	2.5	14.95					
146	153	167	227		2.5	2.5	14.79					
146	153	167	227		2.5	2.5	16.8					
146	153	167	227		2.5	2.5	16.8					
146	153	167	227		2.5	2.5	18.4					
146	163	170	264		3	3	19					
146	239		264	247	3	3	17.8					
146	163	170	264		3	3	17.9					
146	163	170	264		3	3	18.7					
146	163	170	264		3	3	17.9					
146	163	185	264		3	3	18.2					
146	163	170	264		3	3	18.7					
146	243		264	251	3	3	18.5					
146	243		264	251	3	3	19.0					
146	163	170	264		3	3	18.7					
146	163	170	264		3	3	18.7					
146	243		264	251	3	3	18.5					
146	243		264	251	3	3	18.5					
146	163	185	264		3	3	19.0					
146	161	170	264		3	3	28.7	HJ2326	1.8	14	29.17	4
146	161	185	264		3	3	30.0	HJ2326	1.8	14	29.17	4
146	161	185	264		3	3	29.4	HJ2326	1.8	14	29.17	4
146	240		264	246	3	3	29.01					
146	161	185	264		3	3	29.0	HJ2326	1.8	14	29.17	4
146	161	185	264		3	3	29.3	HJ2326E1.79		14	27.69	4
146	161	185	264		3	3	29.1	HJ2326	1.8	14	29.17	4
146	161	185	264		3	3	30.0	HJ2326	1.8	14	29.17	4
146		185	264		3	3	29.5					
146	161	170	264		3	3	29.3					
146	161	170	264		3	3	18.7					
150	180	190	320		4	4	39.5					

Single-row Cylindrical Roller Bearing

d 140 mm

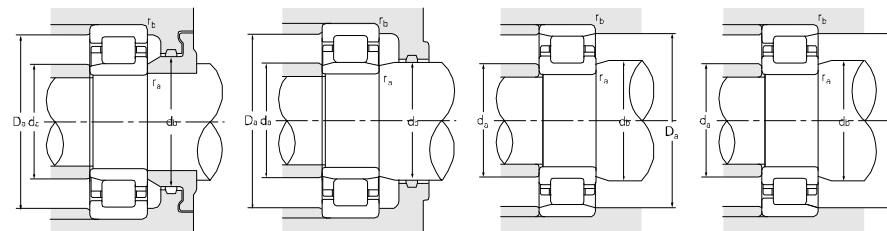
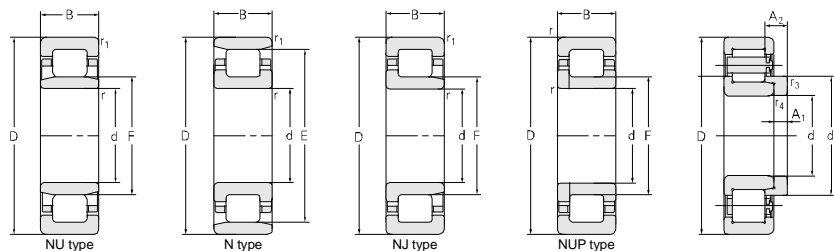

Principal dimensions						Basic load ratings		Limit speed ratings		Designations	
d	D	B	r _{1smin}	r _{smin}	F	E	C _r	C _{0r}	Grease		Oil
						kN		r/min			
140	190	30	1.5	1.1		178	184	315	3000	3600	NF2928M
	190	30	1.5	1.5	152		184	315	3000	3600	NJ2928M
	210	33	2	1.1	158		183	263	3000	3600	NU1028M
	210	33	2	1.1	158		183	263	3000	3600	FL-NU1028M
	210	33	2	1.1	158		195	287	3000	3600	NJ1028M
	210	53	2	1.1	158		358	630	2600	3400	NU3028M
	220	36	2.7	2.3	160		245	345	660	1300	NU1128X3M
	250	42	3	3		221	319	410	2400	3000	N228Q1
	250	42	3	3		221	341	450	2000	2600	NCF228J
	250	42	3	3		221	363	490	2400	3000	N228M
	250	42	3	3	169		363	490	2000	2600	NU228M
	250	42	3	3	169		363	490	2000	2600	NJ228M
	250	42	3	3	169		363	490	2000	2600	NUP228M
	250	42	3	3		225	402	530	2400	3000	N228E
	250	42	3	3	169		402	530	2000	2600	NJ228E
	250	42	3	3	169		402	530	2000	2600	NU228E
	250	42	3	3	169		400	530	2000	2600	NU228EM
	250	42	3	3	169		400	530	2000	2600	NU228EMA
	250	42	3	3	169		400	530	2000	2600	NU228EM/C9
	250	42	3	3	169		400	530	2000	2600	NU228EM/W124
	250	42	3	3	169		402	530	2000	2600	NU228EQ1
	250	42	3	3	169		350	470	2000	2600	NU228M-DT
	250	42	3	3		225	400	530	2000	2600	N228EM
	250	42	3	3	169		365	490	2000	2600	NJ228Q1
	250	68	3	3	169		570	840	2000	2600	NU2228EM
	250	68	3	3	169		510	755	2000	2600	NJP2228Q1/C4S0
	250	68	3	3	169		510	755	2000	2600	NJ2228Q1/C4S0
	250	68	3	3	169		574	836	2000	2600	FL-NU2228EMA/C3
	250	68	3	3	169		480	700	2000	2600	FL-NJ2228M/P6
	250	68	3	3	169		506	755	2000	2600	NU2228M
	250	68	3	3	169		506	755	2000	2600	NJ2228M
	250	68	3	3	169		517	770	2000	2600	NJ2228M/C4YA8
	250	68	3	3	169		572	840	2000	2600	NJ2228E
	250	68	3	3	169		572	840	2000	2600	NU2228E
	250	68	3	3		225	570	840	2000	2600	N2228E
	250	80	3	3	169		682	1040	2000	2600	NJ3228X2M

Abutment and fillet dimensions						Weight	Model	Weight	Separate thrust collar		
d _{amin}	d _{amax}	d _{bmin}	D _{amax}	D _{amin}	r _{amax}				r _{bmax}	A1	A2
mm						kg	kg	mm			
146.5	155	161	181		1	1	2.59				
146.5	155	161	181		2	1	2.6				
146.5	155	161	201		2	1	3.89				
146.5	155	161	201		2	1	3.89				
146.5	155	161	201		2	1	4.01				
147	154	162	200		2	1	7.64				
151	157	163	209		2	2	5.03				
153	218		237	225	2.5	2.5	8.66				
153			237	225	2.5	2.5	7.77				
153	218		237	225	2.5	2.5	9.14				
153	166	172	237		2.5	2.5	9.16				
153	166	183	237		2.5	2.5	9.38				
153		183	237		2.5	2.5	9.51				
153	221		237	232	2.5	2.5	9.01				
150	167	181	237		2.5	2.5	9.20				
150	167	171	237		2.5	2.5	9.05				
150	167	171	237		2.5	2.5	9.23				
150	167	171	237		2.5	2.5	9.11				
150	167	171	237		2.5	2.5	9.23				
150	167	171	237		2.5	2.5	9.23				
153	166	172	237		2.5	2.5	9.37				
153	166	172	237		2.5	2.5	9.16				
153	221		237	232	2.5	2.5	9.19				
153	166	183	237		2.5	2.5	9.24				
153	164	172	237		2.5	2.5	14.3				
153	164	183	237		2.5	2.5	15.1				
153	164	183	237		2.5	2.5	15.1				
153	164	172	237		2.5	2.5	14.2				
153	164	183	237		2.5	2.5	14.8				
153	164	172	237		2.5	2.5	14.4	HJ2228	1.13	11 24.68 3	
153	164	183	237		2.5	2.5	14.8	HJ2228	1.13	11 24.68 3	
153	164	183	237		2.5	2.5	15.0	HJ2228	1.13	11 24.68 3	
153	164	183	237		2.5	2.5	14.5				
153	164	172	237		2.5	2.5	14.2				
154	218	224	236		2.5	2.5	14.2				
153	164	183	237		2.5	2.5	17.8				

Single-row Cylindrical Roller Bearing

d 140~150 mm

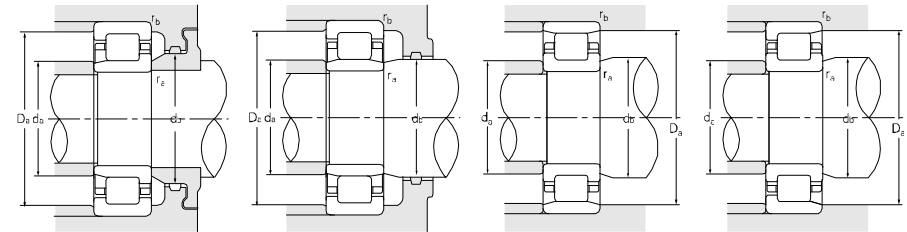
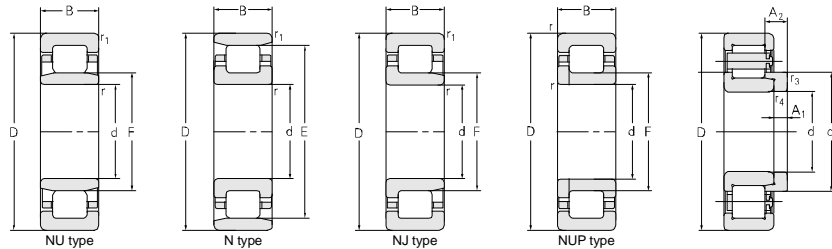

Principal dimensions	Basic load ratings		Limit speed ratings		Designations							
	d	D	B	r _{1smin}		r _{smin}	F	E	C _r	C _{Or}	Grease	Oil
mm	kN					r/min						
140	250	82.5	5.1	3	168.46	693	1060	2000	2600	NU5228XPC3		
	250	82.5	5.1	3	168.46	640	980	2000	2600	NU3228X2M/C9YA6		
	250	100	3	3	169	506	755	2000	2600	NU2228MWB		
	300	62	4	4		260	660	810	1900	2400	N328M	
	300	62	3.7	3.7		260	655	805	1900	2400	NF328M	
	300	62	4	4	180	660	810	1800	2200	NJ328M		
	300	62	4	4	180	660	810	1800	2200	NU328M		
	300	62	4	4	180	660	810	1800	2200	NU328Q1/S0		
	300	62	4	4	180	660	810	1800	2200	NUP328M		
	300	62	4	4	180	655	805	1800	2200	NJ328Q1		
	300	62	4	4	180	715	880	1800	2200	NU328EM		
	300	62	4	4	180	655	805	1800	2200	NU328M-DT		
	300	102	4	4		260	960	1310	1800	2200	N2328M	
	300	102	4	4	180	960	1310	1800	2200	NU2328M		
	300	102	4	4	180	1000	1400	1800	2200	NJ2328M/YA8		
	300	102	4	4	180	960	1310	1800	2200	NJ2328M		
	300	102	4	4	180	960	1310	1800	2200	NJ2328M/W20		
	360	82	5	5	196	1010	1200	1800	2200	NJ428M		
360	82	6	6	196	950	1120	1800	2200	NJ428MA/YAD			
149.959	320	65	3	3	189.796	864	930	1700	2000	NU3/149X4EM		
	320	65	3	3	190.144	880	950	1700	2000	NU3/149X4Q1/HAYB2		
150	210	28	4	3	165	171	270	2700	3300	NJ1930NB1M/YA16		
	210	28	3	4	165	171	270	2700	3300	NJ1930B1M/YA6		
	210	28	2	4	165	170	270	2700	3300	NJ1930B1M/YA6-1		
	215.88	28	4	3		195	180	290	2700	3300	NF1930X1WCM/YA6	
	225	35	2.1	1.5	169.5	212	310	2600	3200	NJ1030M		
	225	35	2.1	2.1	169.5	212	310	2600	3200	NU1030M		
	225	35	2	1.5	169.5	238	320	2600	3200	NU1030Q1/HAYA6		
	225	56	2.1	2.1	169.5	363	620	2400	3000	NU3030M/P6		
	270	45	3	3		238	418	565	2000	2600	N230M	
	270	45	3	3		238	405	550	2000	2600	NF230M	
	270	45	3	3	182	418	565	1900	2400	NU230M		
	270	45	3	3	182	418	565	1900	2400	NJ230M		
	270	45	3	3	182	418	565	1900	2400	NUP230M		
	270	45	3	3		242	457	610	1900	2400	N230E	

Abutment and fillet dimensions				Weight	Model	Weight	Separate thrust collar			
d _{amin}	d _{amax}	d _{bmin}	D _{amax}				D _{amin}	r _{amax}	r _{bmax}	A1
mm	mm			kg	kg	mm				
155	166	172	237				2.5	3		
155	166	172	237				2.5	3		
153	164	172	237				2.5	2.5		
156	256		284	264	3	3			21.9	
156			284	264	3	3			21.8	
156	176	199	284		3	3			22.6	
156	176	183	284		3	3			22.2	
156	176	183	284		3	3			21.7	
156		199	284		3	3			22.3	
156	176	199	284		3	3			22.1	
156	176	183	284		3	3			21.8	
156	176	183	284		3	3			21.9	
156	256		284	264	3	3			34.6	
156	176	183	284		3	3			33.6	
156	176	199	284		3	3			34.7	
156	176	199	284		3	3			34.8	
156	176	199	284		3	3			34.8	
160	192	219	340		4	4			46.3	
160	192	219	340		4	4			48.6	
166	189	196	304		3	3			26.4	
166	189	196	304		3	3			26.7	
166	189	165	180		3	3			2.86	
166	189	165	180		3	3			2.94	
166	189	165	180		3	3			2.94	
136.5	145	151	191		3	2			4.18	
159	166	178	214		2	2			5.05	
159	166	172	214		2	2			4.94	
159	166	172	214		2	2			5.13	
159	166	172	214		2	2			7.99	
163	234		257	242	2.5	2.5			11.6	
163	234		257	242	2.5	2.5			12.1	
163	178	185	257		2.5	2.5			11.8	
163	178	197	257		2.5	2.5			12.0	
163		197	257		2.5	2.5			12.3	
163	238		257	246	2.5	2.5			11.5	

Single-row Cylindrical Roller Bearing

d 150 mm

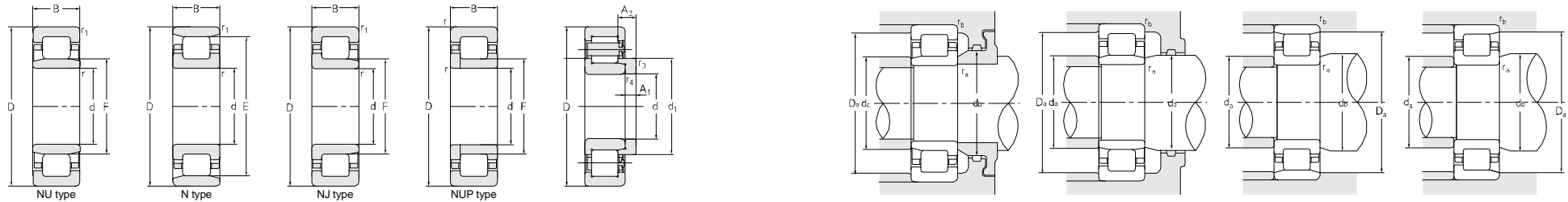

Principal dimensions						Basic load ratings		Limit speed ratings		Designations	
d	D	B	r _{1smin}	r _{smin}	F	E	C _r	C _{0r}	Grease		Oil
mm						kN		r/min			
150	270	45	3	3	182		457	610	1900	2400	NU230E
	270	45	3	3	182		435	570	1900	2400	NU230EM/C9
	270	45	3	3	182		435	570	1900	2400	NU230EM/W124
	270	45	3	3	182		457	610	1900	2400	NU230EQ1
	270	45	3	3	182		457	610	1900	2400	NJ230E
	270	45	3	3	182		405	550	2000	2600	NU230M-DT
	270	45	3	3	182		435	570	2000	2600	NU230EMA
	270	73	3	3	182		634	925	1900	2400	FL-NU2230EMA/C3
	270	73	3	3	182		660	980	1900	2400	NJ2230E
	270	88.9	2.6	6.4	181.53		1020	1610	1800	2200	NU5230XPC3
	270	88.9	2.6	7.5	181.53		980	1550	1800	2200	NU3230X2M/C9YA6
	320	65	4	4		277	715	890	1700	2000	N330M
	320	65	4	4		277	815	1010	1700	2000	N330ENM
	320	65	4	4	193		715	890	1700	2000	NU330M
	320	65	4	4	193		715	890	1700	2000	NJ330M
	320	65	4	4	193		715	890	1700	2000	NUP330M
	320	65	4	4	193		814	1010	1700	2000	NU330EQ1
	320	65	4	4	193		814	1010	1700	2000	NU330EQ1/C9
	320	65	4	4	193		814	1010	1700	2000	NJ330EM
	320	65	4	4	193		996	920	1700	2000	NU330EQ1/YB2
	320	108	4	4	193		814	1010	1700	2000	NU330EWBM
	320	108	4	4	193		1030	1420	1700	2000	NUP2330M
	320	108	4	4		277	1070	1480	1700	2000	NF2330M
	320	108	4	4	193		1070	1480	1700	2000	NU2330M
	320	108	4	4	193		1141	1570	1700	2000	NU2330MA
	320	108	4	4	193		1140	1570	1700	2000	NU2330EMA
	320	108	4	4	193		1030	1420	1700	2000	NJ2330M
	320	108	4	4	193		1070	1480	1700	2000	NJ2330M/YA8-1
	320	108	4	4	193		1070	1480	1700	2000	NJ2330M/YA8
	320	108	4	4	193		1070	1480	1700	2000	NJ2330M/C4W124YA8
	320	108	4	4		277	1030	1420	1700	2000	N2330M
	320	108	4	4	193		1140	1570	1700	2000	FL-NU2330EMA/C3
320	128	4	4	193		1320	1880	1400	1800	NJ3330M	
320	128	4	4	193		1320	1870	1400	1800	NJ330X2EM	

Abutment and fillet dimensions						Weight	Model	Weight	Separate thrust collar		
d _{amin}	d _{amax}	d _{bmin}	D _{amax}	D _{amin}	r _{amax}				r _{bmax}	A1	A2
mm						kg	kg	mm			
163	178	185	247		2.5	2.5	11.2				
163	178	185	247		2.5	2.5	11.3				
163	178	185	247		2.5	2.5	11.3				
163	178	185	257		2.5	2.5	11.8				
163	178	197	257		2.5	2.5	11.6				
163	178	185	257		2.5	2.5	11.7				
163	178	185	247		2.5	2.5	11.6				
163	173	257	257		2.5	2.5	18.4				
163	177	197	257		2.5	2.5	18.1				
167	180	185	260.5		2	2	23.6				
167	180	185	260.5		2	2	23.6				
166	272	304		282	3	3	26.5				
166	272	304		282	3	3	24.8				
166	189	196	304		3	3	26.6				
166	189	213	304		3	3	26.9				
166	189	213	304		3	3	27.4				
166	189	196	304		3	3	26.2				
166	189	196	304		3	3	26.2				
166	189	213	304		3	3	26.2				
166	189	196	304		3	3	26.7				
166	189	196	304		3	3	29.5				
166	189	196	304		3	3	43.1				
166		213	304		3	3	43.6				
166		304		284	3	3	41.5	HJ2330	2.8	15 33.67 3.7	
166	186	196	304		3	3	44.9	HJ2330	2.8	15 33.67 3.7	
166	189	196	304		3	3	44.9	HJ2330E2.64		15 31.19 4	
166	186	213	304		3	3	42.4	HJ2330	2.8	15 33.67 3.7	
166	186	213	304		3	3	42.7	HJ2330	2.8	15 33.67 3.7	
166	186	213	304		3	3	42.7	HJ2330	2.8	15 33.67 3.7	
166	186	213	304		3	3	43.2	HJ2330	2.8	15 33.67 3.7	
166		304		284	3	3	42.8				
166	189	196	304		3	3	42.6				
166	189	213	304		3	3	49.9				
166	189	213	304		3	3	49.9				

Single-row Cylindrical Roller Bearing

d 158.75~160 mm

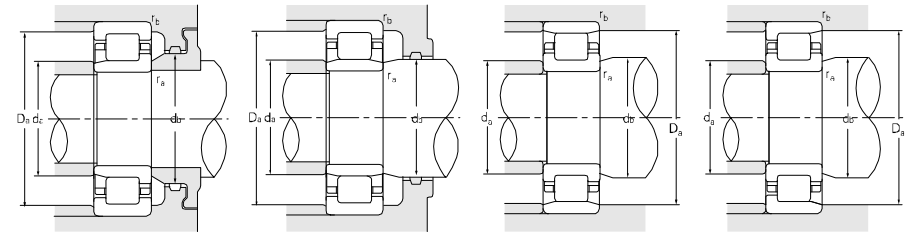
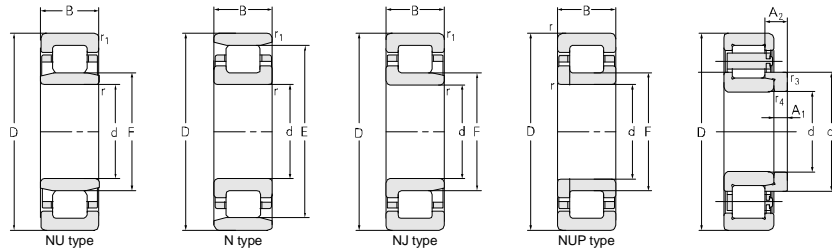

Principal dimensions						Basic load ratings		Limit speed ratings		Designations	
d	D	B	r _{1smin}	r _{smin}	F	E	C _r	C _{0r}	Grease		Oil
mm	mm	mm	mm	mm	mm	mm	kN		r/min		
158	290	110	3	3	193		935	1130	1800	2200	NJ2232WBK3 NJ2232WBK2 N231.775Q4/W33
158.5	290	110	3	3	193		935	1130	1800	2200	
158.75	231.775	161.925	2.1	2.1	176.5		1020	2390	2400	3000	
159	290	85	3	3	193		935	1130	2400	3000	NJ2232WBKY1 NJ2232WBK1
	290	110	3	3	193		935	1130	2400	3000	
160	220	36	2	2	173		255	435	2500	3200	NJ2932M N032X3M N032M N1032M NJ1032M NU1032M NU1032Q1 N232M NU232M NJ232M NUP232M N232E NU232E NU232EM/W124 NU232EM/P59V2 NU232EM/C91 NU232EM/YA8 NU232EMA NU232EQ1 NJ232E NUP232E NU232EM-DT NU232EM/P4YA8 NU2232 NU2232EM NU2232EM/YA8 NJ2232E NJ2232M NJ2232WB11Q1/YB2 NJ2232WB1Q1/YB2 NU2232EMA/YA8-1
	230	22	1.5	1.5		209	160	240	2900	3500	
	240	25	1.5	1.5		216	193	300	2800	3400	
	240	38	2.1	2.1		220	260	365	2400	3000	
	240	38	2.1	1.5	180		259	380	2400	3000	
	240	38	2.1	2.1	180		259	380	2400	3000	
	240	38	2.1	2.1	180		259	380	2400	3000	
	290	48	3	3		257	495	655	1800	2200	
	290	48	3	3	193		495	655	1800	2200	
	290	48	3	3	193		495	655	1800	2200	
	290	48	3	3	193		495	655	1800	2200	
	290	48	3	3		259	517	695	1800	2200	
	290	48	3	3	195		517	695	1800	2200	
	290	48	3	3	195		517	695	1800	2200	
	290	48	3	3	195		517	695	1800	2200	
	290	48	3	3	195		515	695	1800	2200	
	290	48	3	3	195		515	695	1800	2200	
	290	48	3	3	195		495	665	1800	2200	
	290	48	3	3	195		515	695	1800	2200	
	290	48	3	3	195		515	695	1800	2200	
	290	48	3	3	195		515	695	1800	2200	
	290	48	3	3	195		470	615	1800	2200	
	290	48	3	3	195		515	695	1800	2200	
	290	80	3	3	193		688	1000	1800	2200	
	290	80	3	3	193		810	1190	1800	2200	
	290	80	3	3	193		810	1190	1800	2200	
	290	80	3	3	193		809	1190	1800	2200	
	290	80	3	3	195		700	1050	1800	2200	
	290	80	3	3	193		1030	1130	1800	2200	
	290	80	3	3	193		1030	1130	1800	2200	
	290	80	3	3	193		810	1190	1800	2200	

Abutment and fillet dimensions						Weight	Model	Weight	Separate thrust collar		
d _{amin}	d _{amax}	d _{bmin}	D _{amax}	D _{amin}	r _{amax}				r _{bmax}	A1	A2
mm	mm	mm	mm	mm	mm	mm	kg	kg	mm	mm	
173	188	208	277		2.5	2.5	26				
173	188	208	277		2.5	2.5	26				
167	172	177	220		2	2	23.9				
173	188	208	277		2.5	2.5	24.4				
173	188	208	277		2.5	2.5	26				
169	171	181	211		1.5	1.5	4.17				
168	205		220	210	1.5	1.5	3.37				
168	213		229	220	1.5	1.5	4.47				
168	217		232	223	2	2	5.96				
168	177	191	229		2	1.5	6.13				
168	177	183	229		2	2	5.96				
168	177	183	229		2	2	5.86				
173	255		277	263	2.5	2.5	14.3				
173	191	198	277		2.5	2.5	14.4	HJ232	1.4	12 19.68 3	
173	191	210	277		2.5	2.5	14.2	HJ232	1.4	12 19.68 3	
173		210	277		2.5	2.5	14.6				
173	255		277	263	2.5	2.5	13.9				
173	191	198	277		2.5	2.5	14.0				
173	191	198	277		2.5	2.5	14.3				
173	191	198	277		2.5	2.5	14.3				
173	191	198	277		2.5	2.5	14.3				
173	191	198	277		2.5	2.5	14.3				
173	191	198	277		2.5	2.5	13.8				
173	191	198	277		2.5	2.5	14.3				
173	191	198	277		2.5	2.5	14.3				
173	191	210	277		2.5	2.5	14.3				
173	191	210	277		2.5	2.5	14.5				
173	191	198	277		2.5	2.5	14.0				
173	191	198	277		2.5	2.5	13.8				
173	189	196	277		2.5	2.5	23.3				
173	189	196	277		2.5	2.5	24.2				
173	189	196	277		2.5	2.5	23.6				
173	188	208	277		2.5	2.5	24.7				
173	189	196	277		2.5	2.5	23.9				
173	188	208	277		2.5	2.5	24.2				
173	188	208	277		2.5	2.5	26				
173	189	196	277		2.5	2.5	23.1				

Single-row Cylindrical Roller Bearing

d 160~170 mm

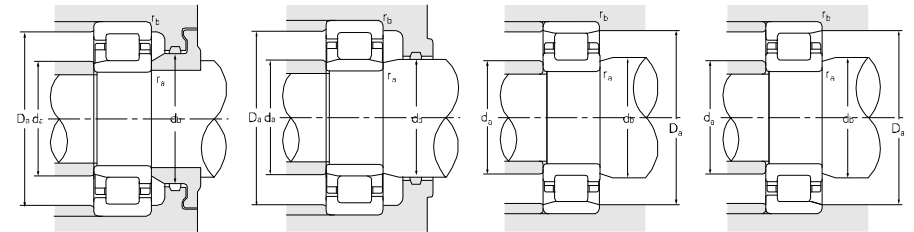
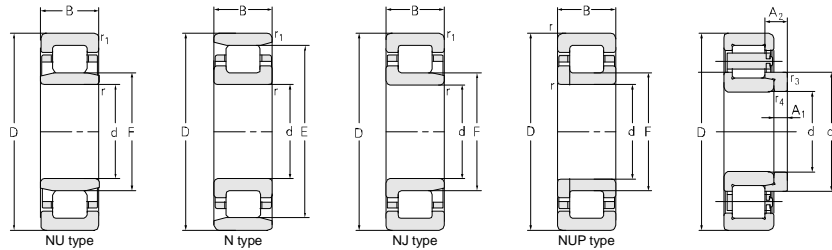

Principal dimensions						Basic load ratings		Limit speed ratings		Designations
d	D	B	r _{1smin}	r _{smin}	F E	C _r	C _{0r}	Grease	Oil	
mm						kN		r/min		
160	290	80	3	3	261	810	1190	1800	2200	N2232ENM
	290	97.5	3	3	193	1030	1130	1800	2200	NU2232WBQ1/YB2
	290	97.5	3	3	193	935	1130	1800	2200	NJ2232WBY
	290	110	3	3	193	935	1130	1800	2200	NJ2232WB
	320	108	4	4	198	1070	1490	1500	1800	N632M
	340	68	4	4	292	750	970	1500	1800	N332M
	340	68	4	4	208	750	970	1500	1800	NU332M
	340	68	4	4	208	750	970	1500	1800	NU332M/YA8
	340	68	4	4	208	750	970	1500	1800	NJ332M
	340	68	4	4	204	858	1050	1500	1800	NU332EQ1/HA
	340	68	4	4	204	919	1150	1500	1800	NU332EQ1
	340	68	4	4	208	755	970	1500	1800	NU332M-DT
	340	68	4	4	204	870	1080	1500	1800	FL-NU332EMA/C3
	340	114	4	4	292	1120	1610	1350	1700	N2332M
	340	114	4	4	204	1260	1730	1350	1700	NU2332EM/C9
	340	114	4	4	204	1120	1730	1350	1700	NU2332EMA
	340	114	4	4	204	1310	1820	1350	1700	NU2332E/YA5
	340	114	4	4	204	1120	1610	1350	1700	NU2332M
	340	114	4	4	208	1120	1610	1350	1700	NJ2332M
	340	114	4	4	204	1120	1610	1350	1700	NUP2332M
170	230	28	2	1.1	216	193	310	2400	2900	N1934M
	260	42	2.1	2.1	237	299	400	2200	2800	N1034M
	260	42	2.1	2.1	193	299	440	2200	2800	NU1034M
	260	42	2.1	2.1	193	299	440	2200	2800	NJ1034M
	265	42	2.1	2.1	237	330	500	580	1100	N1034X1M
	310	52	4	4	272	500	780	1800	2200	N234M
	310	52	4	4	208	550	780	1800	2200	NU234M
	310	52	4	4	208	550	780	1800	2200	NU234M/YA8
	310	52	4	4	208	550	780	1800	2200	NU234Q1
	310	52	4	4	208	550	780	1800	2200	NJ234M
	310	52	4	4	207	640	870	1800	2200	NU234EM
	310	52	4	4	207	640	870	1800	2200	NU234EM/P59V2
	310	52	4	4	207	640	870	1800	2200	NU234EM-DT
	310	52	4	4	207	640	870	1800	2200	FL-NU234EM

Abutment and fillet dimensions							Weight	Model	Weight	Separate thrust collar		
d _{amin}	d _{amax}	d _{bmin}	D _{amax}	D _{amin}	r _{amax}	r _{bmax}				A1	A2	r _{3,4}
mm							kg	kg	mm			
173	198		277		2.5	2.5	23.5					
173	189	196	277		2.5	2.5	24.8					
173	188	208	277		2.5	2.5	25.8					
173	188	208	277		2.5	2.5	26					
176	188	208	304		3	3	40.9					
176	288	324	296	296	3	3	30.8					
176	204	211	324		3	3	30.9					
176	204	211	324		3	3	30.9					
176	204	225	324		3	3	31.5					
176	200	207	324		3	3	31.3					
176	200	207	324		3	3	27.8					
176	204	211	324		3	3	30.6					
176	200	207	324		3	3	31.4					
176	201	209	324		3	3	51.6					
176	201	209	324		3	3	52.4					
176	201	209	324		3	3	53.9					
176	201	209	324		3	3	50.7					
176	201	209	324		3	3	54.4	HJ2332	3.21	15	36.67 4	
176	215	194	324		3	3	54.3	HJ2332	3.21	15	36.67 4	
176	201	209	324		3	3	56.5					
180		213	222	219	1.5	1	3.64					
181	233		249	241	2	2	8.02					
181	190	196	249		2	2	8.23					
181	190	205	249		2	2	8.47					
186	234		254	241	2	2	7.97					
186	266		294	278	3	3	18.2					
186	203	210	294		3	3	17.9					
186	203	210	294		3	3	17.4					
186	203	210	294		3	3	18.1					
186	203	224	294		3	3	19.2					
186	203	210	294		3	3	18.4					
186	203	210	294		3	3	18.4					
186	203	210	294		3	3	18					
186	203	210	294		3	3	18.4					

Single-row Cylindrical Roller Bearing

d 170~180 mm

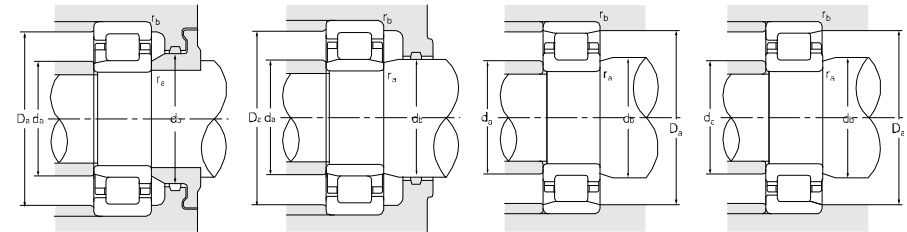
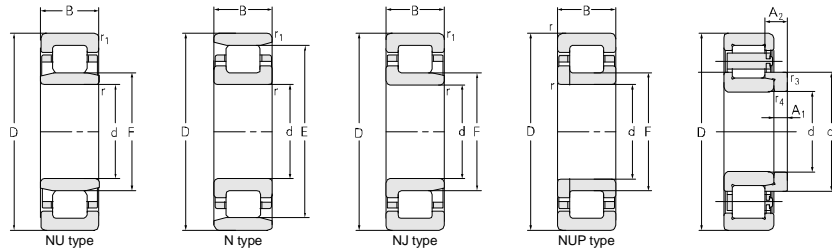

Principal dimensions						Basic load ratings		Limit speed ratings		Designations
d	D	B	r _{1smin}	r _{smin}	F E	C _r	C _{0r}	Grease	Oil	
mm						kN		r/min		
170	310	86	4	4	207	644	870	1800	2200	NU234EWBM
	310	86	4	4	205	1000	1480	1800	2200	NU2234EM
	310	86	4	4	208	875	1400	1800	2200	NU2234M
	310	86	4	4	205	1000	1480	1800	2300	NJ2234EQ1
	310	86	4	4	205	1000	1480	1800	2300	NJ2234EM
	310	86	4	4	205	1000	1480	1800	2300	NJ2234EQ1/YA1
	310	108	4	4	198	1070	1490	1500	1800	NU634M
	340	114	4	4	292	1120	1610	1500	1800	N2334M
	340	114	4	4	208	1120	1610	1500	1800	NU2334M
	360	72	4	4	310	815	1040	1400	1700	N334M
	360	72	4	4	220	810	1040	1400	1700	NU334M
	360	72	4	4	220	810	1040	1400	1700	NJ334M
	360	120	4	4	220	1270	1850	1400	1700	NJ2334M
	360	120	4	4	220	1270	1850	1400	1700	NU2334M
	360	120	4	4	220	1270	1850	1400	1700	NU2334MA
	360	120	4	4	220	1270	1850	1400	1700	NU2334M/C9
180	250	33	2	1.1	233	237	380	2200	2800	NF1936M
	280	31	2	2	250	270	420	2000	2400	N036M
	280	31	2	2	250	270	420	2000	2400	N036L
	280	31	2	2	260	330	472	2000	2400	N036EM
	280	33	2	2	260	341	540	1900	2200	N036X2
	280	46	2.1	2.1	255	380	565	2000	2600	N1036M
	280	50	2.1	2.1	255	420	640	2000	2600	NF1036X2M
	280	46	2.1	2.1	205	418	565	2000	2600	NU1036M
	280	46	2.1	2.1	205	380	565	2000	2600	NJ1036M
	320	52	4	4	282	555	785	1700	2000	N236M
	320	52	4	4	218	555	785	1700	2000	NU236M
	320	52	4	4	218	555	785	1700	2000	NU236M/YA8
	320	52	4	4	217	615	830	1700	2000	NU236EM
	320	52	4	4	218	555	785	1700	2000	NU236M-DT
	320	52	4	4	218	555	785	1700	2000	NJ236M
	320	52	4	4	218	555	785	1700	2000	NUP236M
	320	52	4	4	218	555	785	1700	2000	NU236M-DT/YB2
	320	52	4	4	218	555	785	1700	2000	NU236L3-DT
	320	52	4	4	218	555	785	1700	2000	NU236L3-DT/YB2

Abutment and fillet dimensions							Weight	Model	Weight	Separate thrust collar		
d _{amin}	d _{amax}	d _{bmin}	D _{amax}	D _{amin}	r _{amax}	r _{bmax}				A1	A2	r _{3,4}
mm							kg	kg	mm			
186	203	210	294		3	3	21.4					
186	201	208	294		3	3	29.0					
187	203	211	293		3	3	30.5					
187		212	293		3	3	29.5					
187		212	293		3	3	29.5					
187		212	293		3	3	29.5					
176	195	201	304		3	3	40.9					
176	288		324	295	3	3	51.6					
176	200	211	324		3	3	54.4					
186	307		344	315	3	3	37.3					
186	214	223	344		3	3	37.7					
186	214	243	344		3	3	38.4					
186	212	240	344		3	3	62.5					
186	212	223	344		3	3	61.1					
186	212	223	344		3	3	61.5					
186	212	223	344		3	3	61.3					
190			240	236	1.5	1.5	4.96					
191	246		269	254	2	2	8.59					
191	246		269	254	2	2	7.08					
191	246		269	254	2	2	7.15					
191	256		269	264	2	2	8.44					
191	221		265	260	2	2	10.3					
191	221		265	260	2	2	11.9					
191	202	208	269		2	2	10.4					
191	202	208	269		2	2	10.7					
196	278		304	286	3	3	19.7					
196	213	220	304		3	3	19.2					
196	213	220	304		3	3	19.4					
196	202	208	304		3	3	18.7					
196	213	220	304		3	3	19.4					
196	213	234	304		3	3	19.3					
196		234	304		3	3	20.5					
196	213	220	304		3	3	19.4					
196	213	220	304		3	3	18.6					
196	213	220	304		3	3	18.6					

Single-row Cylindrical Roller Bearing

d 180~190 mm

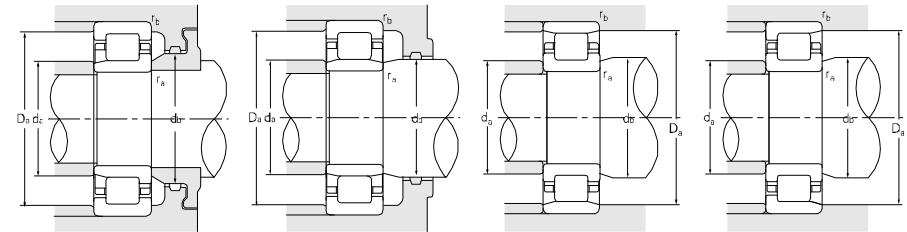
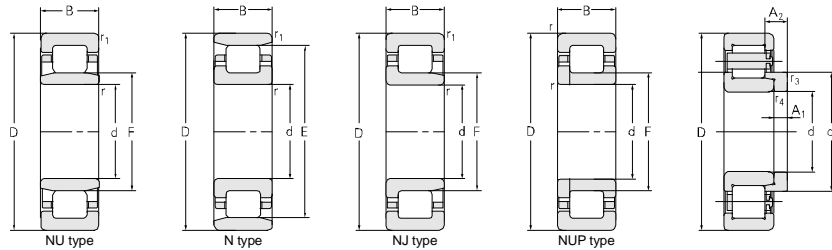

Principal dimensions						Basic load ratings		Limit speed ratings		Designations	
d	D	B	r _{1smin}	r _{smin}	F	E	C _r	C _{0r}	Grease		Oil
mm						kN		r/min			
180	320	86	4	4	215		1050	1580	1700	2000	NU2236M
	320	86	4	4	215		1100	1580	1700	2000	NU2236EM
	320	86	4	4	215		1050	1580	1700	2000	NJ2236M
	320	86	4	4	215		1100	1580	1700	2000	NJ2236EM
	320	86	4	4	215		1100	1580	1700	2000	NJ2236EQ1
	320	86	4	4	215		1050	1580	1700	2000	NUP2236M
	320	112	4	4	218		1120	1950	1700	2000	NU3236M/C3
	320	112	4	4	218		1120	1950	1700	2000	NU3236M/HC
	380	75	4	4		330	990	1260	1500	1800	N336M
	380	75	4	4	230		990	1260	1500	1800	NU336M
	380	75	4	4	230		990	1260	1500	1800	NJ336M
	380	75	4	4	231		1170	1360	1500	1800	NJ336EM
	380	75	4	4	231		1170	1360	1500	1800	NU336EM
	380	75	4	4	231		1060	1360	1500	1800	NU336EMA
	380	126	4	4	232		1360	1850	1300	1600	NJ2336M
	380	126	4	4	232		1360	1850	1300	1600	NU2336M
190	260	42	2	1.1	208		347	685	2200	2800	NU2938Q1
	260	42	2	2	208		315	610	2200	2800	NJ2938
	290	46	2.1	2.1	215		413	640	2000	2600	NU1038M
	290	46	2.1	2.1	215		435	600	2000	2600	NJ1038Q1/HAP63
	340	55	4	4	231		710	980	1600	1900	NU238EM/C9
	340	55	4	4	231		620	885	1600	1900	NU238M
	340	55	4	4	231		620	885	1600	1900	NJ238M
	340	55	4	4	231		620	885	1600	1900	NUP238M
	340	55	4	4		306	710	980	1600	1900	N238EM
	340	55	4	4	230		710	980	1600	1900	NU238EM-DT
	340	92	4	4	228		1140	1750	1600	1900	NU2238M
	340	92	4	4	228		1210	1660	1600	1900	NJ2238EM
	340	120	4	4	231		1320	2340	1600	1900	NU3238M/C3
	400	78	5	5	245		1040	1370	1200	1500	NJ338M
	400	78	5	5	245		1040	1370	1200	1500	NU338M
	400	78	5	5		345	1040	1730	1200	1500	N338M
400	132	5	5	240		1870	2450	1200	1500	NU2338EMA	
400	132	5	5	245		1560	2300	1200	1500	NU2338M	

Abutment and fillet dimensions						Weight	Model	Weight	Separate thrust collar			
d _{amin}	d _{amax}	d _{bmin}	D _{amax}	D _{amin}	r _{amax}				r _{bmax}	A1	A2	r _{3,4}
mm						kg	kg	mm				
196	211	218	304		3	3	31.4					
196	211	218	304		3	3	30.3	HJ2236E1.94	12	23.67	4	
196	211	232	304		3	3	31.9					
196	211	232	304		3	3	31.0	HJ2236E1.94	12	23.67	4	
196	211	232	304		3	3	31.7					
196	211	232	304		3	3	32.1					
196	211	218	304		3	3	41.6					
196	211	218	304		3	3	41.6					
196	325	364		335	3	3	39.6					
196	226	236	364		3	3	42.8	HJ336	3.1	17	29.16	4
196	226	236	364		3	3	43.6	HJ336	3.1	17	29.16	4
196	226	254	364		3	3	42.7					
196	226	236	364		3	3	42.1					
196	226	236	364		3	3	43.3					
196	227	255	364		3	3	72.0					
196	227	236	364		3	3	69.5					
196	206	210	252		1.5	1	6.98					
196	206	210	252		1.5	1	7.24					
201	212	218	279		2	2	10.9					
201	212	218	279		2	2	11.2					
206	226	234	324		3	3	22.8					
206	226	234	324		3	3	21.6	HJ238	2.04	13	23.13	4
206	226	248	324		3	3	22.0	HJ238	2.04	13	23.13	4
206	226	248	324		3	3	22.3					
206	236	324			3	3	22.6					
206	226	234	324		3	3	22.5					
206	223	232	324		3	3	38.6					
206	232	218	324		3	3	39.6					
206	223	232	324		3	3	51.2					
206	240	266	380		4	4	49.4	HJ338	4.3	18	31.65	5
210	240	249	380		4	4	48.5	HJ338	4.3	18	31.65	5
210	340	380	350		4	4	50.2					
210	235	249	380		4	4	82.8					
210	230	380			4	4	82.9					

Single-row Cylindrical Roller Bearing

d 190.5-220 mm

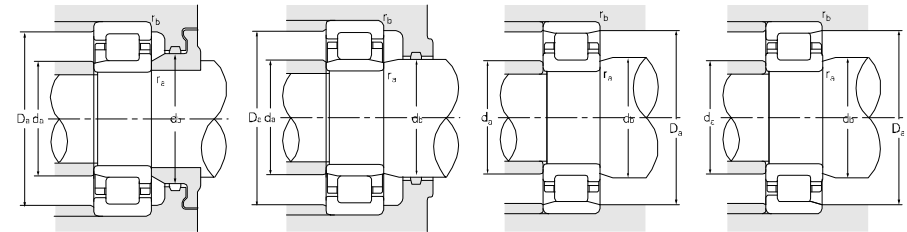
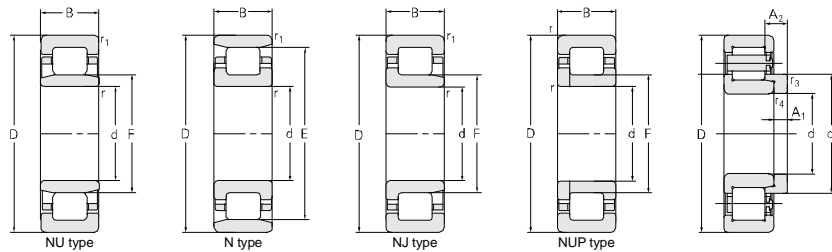

Principal dimensions						Basic load ratings		Limit speed ratings		Designations	
d	D	B	r _{1smin}	r _{smin}	F	E	C _r	C _{0r}	Grease		Oil
mm						kN		r/min			
190.5	266.7	103.188	2	1.1	2.8		715	1480	1500	1800	NU6/190.5/W33X
200	310	34	2	2		277	336	545	2200	2800	N040M
	310	51	2.1	2.1	227		468	705	1900	2400	NU1040M
	310	51	2.1	2.1	227		468	705	1900	2400	NJ1040M
	310	100	2.5	2.5	275.5	234.5	930	2110	1900	2400	NAOL4040X2
	320	48	2.1	2.1		283	473	705	1900	2400	N640M
	320	88.9	3	3	232.689		776	1350	1700	2000	NU3040X3M/C3
	320	88.9	3	3	232.689		776	1350	1700	2000	NU3040X3M/C4-NJB
	360	58	4	4		316	690	995	1500	1800	N240M
	360	58	4	4	244		688	995	1500	1800	NU240M
	360	58	4	4	244		780	1090	1500	1800	NU240EMA
	360	58	4	4	244		625	995	1500	1800	NJ240M
	360	98	4	4	244		970	1550	1500	1800	NJ2240M
	360	98	4	4	244		996	1600	1500	1800	NUP2240M
	360	98	4	4		325	1240	1900	1500	1800	N2240EM
	360	98	4	4	241		1230	1980	1500	1800	NU2240EM
	360	98	4	4	241		1230	1900	1500	1800	NU2240EM/C9W33A
	360	98	4	4		325	1240	1900	1500	1800	N2240EM/YA1
	360	98	4	4	241		1240	1900	1500	1800	FL-NJ2240EMA/P6
	360	115	4	4	244		957	1520	1900	2400	NU1240X2WBM/HG2
	360	120.65	4	4	244		1280	2190	1900	2400	NU5240XPC3
	420	80	5	5	260		1090	1400	1300	1600	NU340M
	420	138	5	5	260		1650	2510	1200	1500	NJ2340M
	420	138	5	5		364	1650	2510	1200	1500	N2340M
	420	138	5	5	260		1650	2510	1200	1500	NU2340MA
	420	138	5	5	253		2040	2880	1200	1500	NU2340EM/P5YA4-FYT
	420	138	5	5	256		1970	2450	1200	1500	NJ2340M/YA4
	420	165	5	5	260		2150	3540	1200	1500	NU3340M
	420	165	5	5	260		2150	3540	1200	1500	NUP3340
	420	165	5	5	260		2310	3400	1200	1500	NU3340M/HCW20T
203.23	310	82	3	3	229.006		880	1410	1000	1200	NU30/203X4Q1/HA
220	300	48	2.1	1.5	240		407	755	1900	2400	NU2944Q1

Abutment and fillet dimensions						Weight	Model	Weight	Separate thrust collar		
d _{amin}	d _{amax}	d _{bmin}	D _{amax}	D _{amin}	r _{amax}				r _{bmax}	A1	A2
mm						kg	kg	mm			
197		200	257		2	1	18				
211	274		299	280	2	2	10.1				
211	225	233	299		2	2	14.3	HJ1040	1.70	13 24.13 2.1	
211	225	242	299		2	2	14.7	HJ1040	1.70	13 24.13 2.1	
211	225	233	299		2	2	30.2				
211	280		299	286	2	2	14.7				
211	225	235	309		3	3	28.7				
211	225	235	309		3	3	28.7				
216	310		344	322	3	3	26.8				
216	239	247	344		3	3	26.5				
216	239	247	344		3	3	27.5	HJ240E	2.72	14 23 4	
216	239	262	344		3	3	27.1				
216	236	260	344		3	3	45.5				
216		260	344		3	3	46.3				
216	320		344	330	3	3	44.9				
216	236	245	344		3	3	42.2				
216	236	245	344		3	3	42.0				
216	320		344	330	3	3	44.9				
216	236	230	344		3	3	46.7				
211	225	233	299		2	2	42.9				
211	225	233	299		2	2	57.6				
220	253	264	400		4	4	56.7	HJ340	5.2	18 32.63 5	
220	241	251	400		4	4	99	HJ2340	6.13	18 41.6 5	
220	360		400	368	4	4	94.5				
220		243	400		4	4	95.6	HJ2340	6.13	18 41.6 5	
220		240	400		4	4	96.7				
220	241	251	400		4	4	98.4	HJ2340	6.13	18 41.6 5	
220	253	264	400		4	4	118				
220		282	400		4	4	121				
220	253	264	400		4	4	115				
220	253	230	290		2	2	23.9				
229	237	243	289		2	1	10.5				

Single-row Cylindrical Roller Bearing

d 220~240 mm

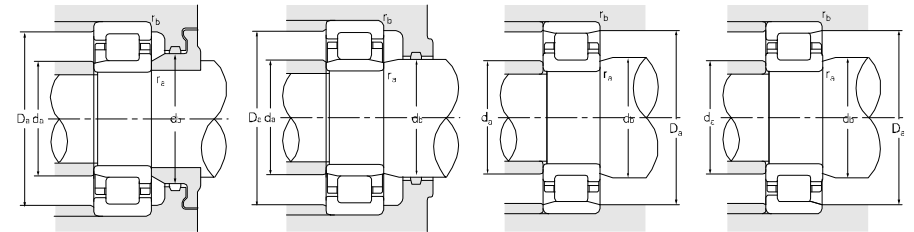
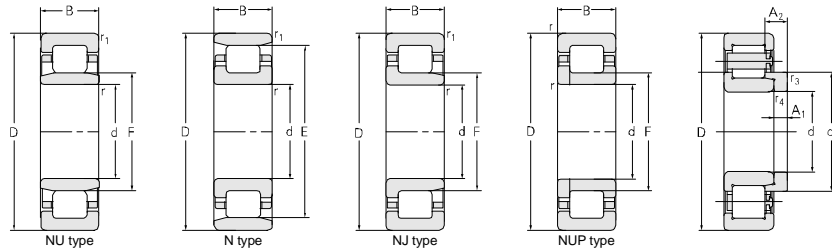

Principal dimensions						Basic load ratings		Limit speed ratings		Designations	
d	D	B	r _{1smin}	r _{smin}	F	E	C _r	C _{0r}	Grease		Oil
mm						kN		r/min			
220	300	48	2.1	2.1	240		407	750	1900	2400	NJ2944M
	340	56	3	3	250		517	775	1800	2200	NU1044Q1
	340	56	3	3	250		534	810	1800	2200	NJ1044M
	340	56	3	3	250		534	810	1800	2200	NU1044M
	340	56	3	3	250		534	810	1800	2200	NFP1044M
	340	56	3	3	250	310	530	810	1800	2200	NU3044Q1/HA
	340	90	3	3	251.409		1060	1820	1800	2200	NU3044X3M/C9
	350	98.4	3	3	253		1280	2090	1800	2200	NU3044M/HG2W33A
	350	90	3	3	253		965	1830	1800	2200	NU3044X3M/C9-NJB
	350	98.4	3	3	253		1280	2090	1800	2200	NU3044X3M/C91YA6
	350	98.4	3	5	253		1280	2090	1800	2200	NU3044X3M/C92YA6-LS
	400	65	4	4		350	836	1220	1500	1800	N244M
	400	65	4	4	270		835	1220	1500	1800	NJ244M
	400	65	4	4	270		835	1440	1990	1800	NU244M
	400	65	4	4	270		835	1220	1500	1800	NUP244M
	400	108	4	4	270		1220	1990	1300	1600	NU2244M
	400	144	4	4	270		1950	3350	1500	1800	NB3244F1
	400	108	4	4	270		1440	1990	1300	1600	NJ2244M
	400	108	4	4	270		1490	2280	1300	1600	NU2244EM
	400	108	4	4	270		1440	1990	1300	1600	N2244M/YA1
	400	108	4	4	265		1490	2280	1300	1600	NU2244EM/HC
	400	108	4	4	265		1490	2280	1300	1600	NU2244EMA
	400	108	4	4	270		1440	1990	1300	1600	N2244M
	460	88	5	5	284		1280	1730	1000	1300	NU344M
	460	88	5	5	282		1370	1840	1000	1300	NJ344EM
	460	145	5	5	284		2040	2780	1000	1300	NU2344M/C3
	460	145	5	5	284		2040	2780	1000	1300	NU2344M
	460	145	5	5	284		2170	3270	1000	1300	NU2344M/C9
	460	145	5	5	275		2310	3400	1000	1300	NU2344E/YA5
	460	145	5	5		407	2300	3360	1000	1300	N2344EM
	460	145	5	5	275		2230	3250	950	1100	NU2344EMA
240	320	38	2.5	1.8	260		308	540	1900	2400	NU1948M
	320	38	2.5	1.8	260		310	540	1900	2400	NJ1948M
	360	56	3	3	270		512	775	1700	2000	NU1048M

Abutment and fillet dimensions								Weight	Model	Weight	Separate thrust collar		
d _{amin}	d _{amax}	d _{bmin}	D _{amax}	D _{amin}	r _{amax}	r _{bmax}					A1	A2	r _{3,4}
mm								kg	kg	mm			
229	237	243	289		2	2		10.8					
233	246	254	327		2.5	2.5		19.4					
233	246	265	327		2.5	2.5		19.6					
233	246	254	327		2.5	2.5		19.2					
233	246	254	327		2.5	2.5		20.2					
233	246	254	327		2.5	2.5		32					
233	248	257	332		2.5	2.5		38.1					
233	248	257	332		2.5	2.5		32.4					
233	248	257	332		2.5	2.5		38.1					
233	248	257	332		2.5	2.5		38					
233	248	257	332		2.5	2.5		38					
236	342	384		358	3	3		36.7					
236	263	290	384		3	3		35.4	HJ244	3.78	15	27.13	4
236	263	276	384		3	3		35.0	HJ244	3.78	15	27.13	4
236	263	276	384		3	3		38.8					
236	262	274	384		3	3		62.2					
236	263	276	384		3	3		77.3					
236	262	290	384		3	3		63.3					
237	255	264	383		3	3		62.8					
237	255	360	383		3	3		61.8					
237	255	264	383		3	3		62.8					
237	255	264	383		3	3		63.8					
237	255	360	383		3	3		61.8					
240	277	288	440		4	4		73.4	HJ344	6.7	20	35.62	5
240	292	270	440		4	4		75.6					
240	276	288	440		4	4		125					
240	276	288	440		4	4		125					
240	276	288	440		4	4		114					
240	403	440		411	4	4		121					
240	403	440		411	4	4		114					
240	268	280	440		4	4		116					
249	257	263	308		2	1.5		8.50					
249	251	260	308		2	1.5		8.74					
253	266	274	347		2.5	2.5		20.5					

Single-row Cylindrical Roller Bearing

d 240~260 mm

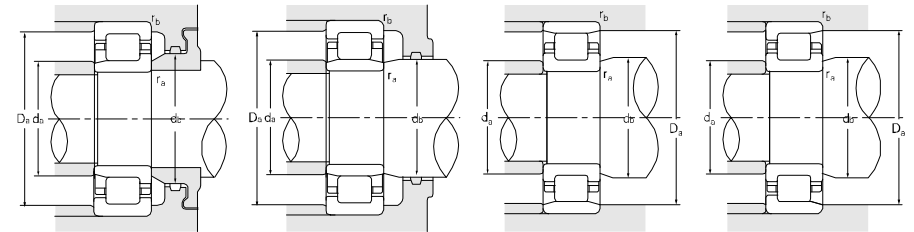
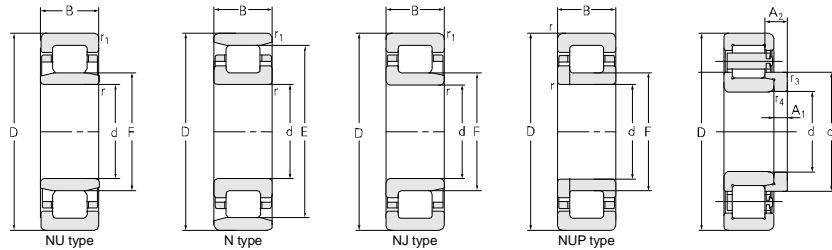

Principal dimensions						Basic load ratings		Limit speed ratings		Designations	
d	D	B	r _{1smin}	r _{smin}	F	E	C _r	C _{0r}	Grease		Oil
mm						kN		r/min			
240	360	56	3	3	270		512	775	1700	2000	NJ1048M
	360	56	3	3	270		545	855	1700	2000	NU1048Q1
	360	56	3	3	270		510	775	1700	2000	NU1048MA
	360	56	3	3	270		510	775	1700	2000	NU1048MA/P4
	390	108	4	4	278		1210	2060	1500	1800	NU2148X3M
	390	107.95	3	3	272.26		1400	2230	1500	1800	NUP2148X3M/C9YA1
	440	72	4	4	295		1050	1540	1300	1600	NU248M
	440	72	4	4	295		1050	1185	1690	1600	NU248EMA
	440	72	4	4	295		1050	1540	1300	1600	NJ248M
	440	72	4	4		385	1050	1540	1300	1600	N248M
	440	72	4	4		393	1180	1690	1300	1600	N248EM
	440	120	4	4	295		1490	2450	1200	1500	NU2248MA
	440	146	4	4	290		2240	3820	1100	1400	NU5248/P5
	500	95	5	5		430	1530	2120	1000	1300	N348M
	500	95	5	5	310		1530	2120	1000	1300	NU348M
	500	95	5	5	306		1670	2190	1000	1300	NU348EM
	500	155	5	5	310		2190	3360	950	1200	NU2348MA
	500	155	5	5	310		2190	3360	950	1200	NU2348M
500	155	5	5	303		2640	4000	950	1200	NU2348E/YA5	
250	308	50	6	2.3		347	655	1050	1800	2300	N650EM/HAC9
260	360	46	2.1	2.1		337	445	785	1600	1850	NF1952M
	360	75	3	3	285		740	1470	1600	1850	NUP3952M/C9W33YA8
	360	75	3	3	285		860	1780	1600	1850	NUP3952M/C9W33
	400	65	4	4		347	690	1090	1500	1800	NU1052M
	400	65	4	4	296		690	1090	1500	1800	NUP1052M
	400	65	4	4	296		690	1090	1500	1800	NJ1052M
	400	82	4	4	294		1080	1880	1300	1700	NU2052EM
	400	82	4	4	294		1090	1880	1300	1700	NU2052ENM
	400	104	4	4	290.5		1350	2340	1150	1450	NU3052M
	440	144	4	4	298.5		2050	3450	950	1250	NU3152M
	440	144	4	4	305		2090	3800	950	1250	NB3152M
	480	80	5	5	320		1220	1800	1100	1400	NU252M
	480	80	5	5	320		1370	1970	1100	1400	NU252EMA
	480	80	5	5	320		1220	1800	1050	1350	NJ252M

Abutment and fillet dimensions								Weight	Model	Weight	Separate thrust collar		
d _{amin}	d _{amax}	d _{bmin}	D _{amax}	D _{amin}	r _{amax}	r _{bmax}					A1	A2	r _{3,4}
mm								kg	kg	mm			
253	266	274	347		2.5	2.5		21.1					
253	266	274	347		2.5	2.5		21.2					
253	266	274	347		2.5	2.5		19.6					
253	266	274	347		2.5	2.5		19.6					
253	266	280	410		3	3		51.2					
253	266	280	410		2.5	2.5		50.5					
256	288	299	424		3	3		46.9					
256	288	299	424		3	3		51.3					
256	288	317	424		3	3		49.6					
256	288	317	424		3	3		49.1					
256	288	300	424		3	3		50.5					
256	284	299	423		3	3		84.8					
256	287	293	424		3	3		104					
260	426	480		434	4	4		96.3					
260	302	314	480		4	4		96.3					
260	296	313	480		4	4		94.9					
260	296	314	480		4	4		155					
260	296	314	480		4	4		154					
260	296	314	480		4	4		154					
268	343		368	351	5	2		21.4					
276	280	295	346		2	2		14.9					
274	280	287	346		2	2		24.5					
274	280	287	346		3	3		24.9					
276	291	300	384		3	3		30.2					
276	291	313	384		3	3		37.2					
276	291	300	384		3	3		36.3					
276	291	300	384		3	3		40.1					
276	291	300	384		3	3		40.1					
275	286	295	385		3	3		49.5					
277	295	302	423		3	3		98					
277	295	302	423		3	3		86.4					
280	313	324	460		4	4		67.1					
280	313	324	460		4	4		68.4					
280	313	324	460		4	4		68.5					

Single-row Cylindrical Roller Bearing

d 260~280 mm

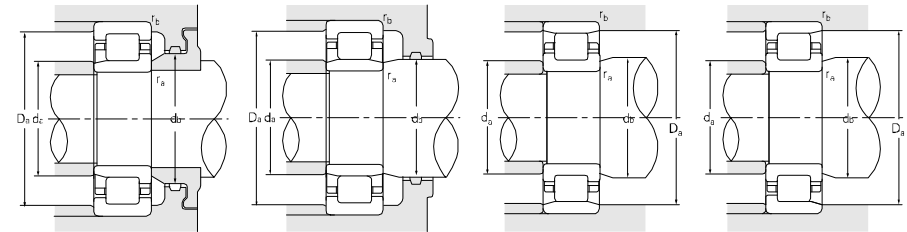
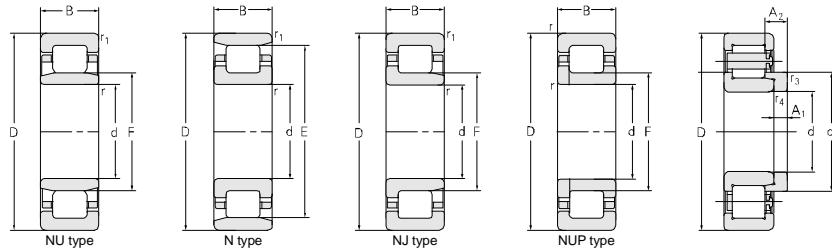

Principal dimensions						Basic load ratings		Limit speed ratings		Designations	
d	D	B	r _{1smin}	r _{smin}	F	E	C _r	C _{0r}	Grease		Oil
mm						kN		r/min			
260	480	80	5	5	320		1220	1800	1050	1350	NJ252MA
	480	80		5	320		1220	1800	1050	1350	NUP252M
	480	80	5	5	317		1370	1970	1050	1350	NJ252EM/YA8
	480	130	5	5	320		1780	2910	1000	1300	NU2252
	480	130	5	5	320		1750	2910	1000	1300	NU2252MA
	480	130	5	5	1780	420	1780	2910	950	1250	N2252M
	480	130	5	5	320		1780	2910	950	1250	NJ2252M
	480	150	5	5	320		2100	3600	950	1250	NU2252X2M
	540	102	6	6	336		1690	2290	850	1050	NU352M
	540	165	6	6	319		3150	4500	850	1050	NU2352M
	540	165	6	6	319		3200	4720	850	1050	NJD2352M/YA8
	280	340	30	2	2		327	308	690	1800	2200
350		42	2	2	299		363	790	1800	2200	NJ2856M
360		30	2	2	301		385	625	1700	1900	NJ1856X3M/HG2
360		30	2	2		341	385	625	1700	1900	N1856X3M/HG2P6-1
380		46	2.1	2.1	306		473	865	1700	1900	NU1956M
380		46	2.1	2.1		354	325	533	1700	1900	NF1956M
420		65	4	4		384	700	1150	1400	1700	N1056M
420		65	4	4	316		700	1150	1400	1700	NU1056M
420		65	4	4	316		700	1150	1400	1700	NJ1056M
420		82	4	4	314		1190	2170	1050	1300	NU2056M
420		82	4	4	314		1110	1980	1050	1300	NU2056EMA
440		135	3	3	318		1880	3400	1100	1400	NB4056X3M
460		123.825	5	5	320.675		1900	3300	900	1150	NU2156X2M/YA4-1
500		80	5	5	340		1100	1750	1150	1450	NJ256M
500		80	5	5	340		1100	1750	1150	1450	NU256M
500		80	5	5	440		1140	1700	1150	1450	N256M/SPC9W33
500		130	5	5	333		2090	3270	1100	1400	NU2256E
500		130	5	5	333		2080	3270	1100	1400	NU2256EF3
500		130	5	5	333		2080	3270	1100	1400	NU2256EM
500		130	5	5	333		2080	3270	1100	1400	NU2256EM-1
500		165.1	5	5	333		2820	4900	950	1300	NU3256X2/C9YA1
580		108	6	6	362		1880	2660	850	1000	NU356M

Abutment and fillet dimensions								Weight	Model	Weight	Separate thrust collar		
d _{amin}	d _{amax}	d _{bmin}	D _{amax}	D _{amin}	r _{amax}	r _{bmax}					A1	A2	r _{3,4}
mm								kg	kg	mm			
280	313	324	460		4	4		68.3					
280	313	324	460		4	4		70					
280	313	324	460		4	4		68.8					
280	309	324	460		4	4		106					
280	309	324	460		4	4		107					
280	416	427	460		4	4		105					
280	309	324	460		4	4		108					
280	309	324	460		4	4		128					
286	330	341	514		5	5		120					
286	310	323	514		5	5		188					
286	310	323	514		5	5		165					
289		324	330	330	2	2		5.76					
289	309	324	330		2	2		9.15					
289	309	334	340		2	2		8.11					
289	309	340	330		2	2		8					
291	303	309	369	330	2	2		15.5					
291		340	308		2	2		16.9					
291		340	308		2	2		31.5					
296	380	411	388		3	3		30.9					
296	311	320	404		3	3		32.2					
296	311	332	404		3	3		39.5					
295	310	318	405		3	3		42					
295	310	318	405		3	3		75.4					
295	311	340	405		3	3		85.8					
296	316	325	424		3	3		71.5					
300	316	325	440		4	4		70					
300	333	364	480		4	4		70.2					
300	333	344	480		4	4		116					
300	350	480	480		4	4		116					
300	333	344	480		4	4		118					
300	333	344	480		4	4		118					
300	333	344	480		4	4		142					
300	333	344	480		4	4		147					
300	333	344	480		4	4		232					
306	347	366	554		5	5							

Single-row Cylindrical Roller Bearing

d 290~320 mm

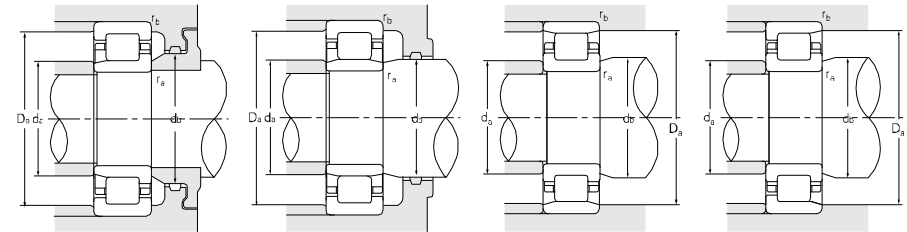
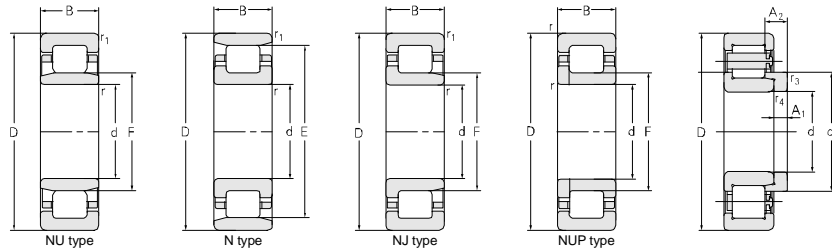

Principal dimensions						Basic load ratings		Limit speed ratings		Designations	
d	D	B	r _{1smin}	r _{smin}	F	E	C _r	C _{0r}	Grease		Oil
mm						kN		r/min			
290	420	65	4	4		389	730	1200	1300	1600	NFP10/290K
300	380	48	2.1	2.1		321	450	1000	1370	1650	NJ2860M
	380	48	2.1	2.1		321	450	1000	1370	1650	NU2860M
	380	60	2.1	2.1	360	468	990	1200	1500		N3860M/HG2
	420	90		3	328.5	1150	2250	1350	1600		NUP3960M/C9W33YA8
	420	90		3	328.5	1150	2250	1350	1600		NUP3960M/C9W33
	460	57	4	4	344	770	1250	1400	1700		NJ1060X2M
	460	74	4	4	340	935	1510	1200	1500		NJ1060M
	460	74	4	4	340	935	1510	1200	1500		NU1060M
	460	74	4	4	340	935	1510	1200	1500		NU1060M/HA
	460	95	4	4	341	1400	2510	980	1250		NU2060M
	460	95	4	4	341	1400	2510	980	1250		NU2060MA
	460	118	4	4	340	1470	2700	1200	1500		NU3060M
	540	85	5	5	364	1510	2270	1000	1300		NU260M
	540	140	5	5	364	2080	3450	1000	1200		NU2260M
	620	109	7.5	7.5	385	2310	3300	900	1100		NU360M
	320	400	38	2.1	1.5	341	365	715	1270	1550	
400		48	2.1	1.5	341	490	1050	1250	1550		NU2864M
440		56	3	3	350	638	1130	1100	1400		NU1964M
440		56	3	3	350	670	1150	1100	1400		FL-NU1964EMA
440		90	3	3	350	1060	2190	1100	1400		NUP3964M/C9
480		74	4	4	360	960	1580	1100	1400		NJ1064M
480		74	4	4	360	910	1490	1100	1400		NU1064M
480		74	4	4	360	915	1490	1100	1400		NU1064MA
480		74	4	4	360	957	1580	1100	1400		NU1064KM/C9
480		74	4	4	360	910	1490	1100	1400		NUP1064M
480		95	4	4	360	1380	2650	970	1250		NU2064M
540		176	5	5	374	2780	5000	870	1050		NU3164M
580		92	5	5	390	1620	2450	960	1200		NU264M
580		150	5	5	390	2480	4150	900	1100		NU2264
580		150	5	5	380	2700	4200	900	1100		NU2264EM
580		170	5	5	390	2940	5200	900	1100		NU2264X2M-1

Abutment and fillet dimensions								Weight	Model	Weight	Separate thrust collar		
d _{amin}	d _{amax}	d _{bmin}	D _{amax}	D _{amin}	r _{amax}	r _{bmax}					A1	A2	r _{3,r4}
mm								kg	kg	mm			
305	320	332	404		3	3		33.2					
310	318	332	370		1.5	1.5		15.5					
310	318	324	370		1.5	1.5		14.5					
316	335		444	440	4	4		16.6					
314		333	406					41					
314		333	406					40.7					
316	335	358	444		3	3		36.5					
316	335	358	444		3	3		45.1					
316	335	344	444		3	3		44.1					
316	335	344	444		3	3		44.1					
317	336	345	443		3	3		60					
317	336	345	443		3	3		60					
316	335	344	444		3	3		72.5					
320	358	368	520		4	4		86.9					
320	352	368	520		4	4		146					
330	379	390	590		7	7		166					
327	337	345	389		2	1.5		11.3					
327	337	345	389		2	1.5		15					
335	346	354	425		2.5	2.5		24.7					
335	346	354	425		2.5	2.5		24.7					
334		354	426		2.5	2.5		45.8					
336	355	380	464		3	3		47.8					
336	355	364	464		3	3		48.2					
336	355	364	464		3	3		48.2					
336	355	364	464		3	3		46.3					
336	355	380	464		3	3		49.1					
335	357	364	465		3	3		63					
367	369	387	490		4	4		172					
340	383	394	560		4	4		112					
340	377	394	560		4	4		181					
340	377	394	560		4	4		181					
340	377	394	560		4	4		212					

Single-row Cylindrical Roller Bearing

d 320~360 mm

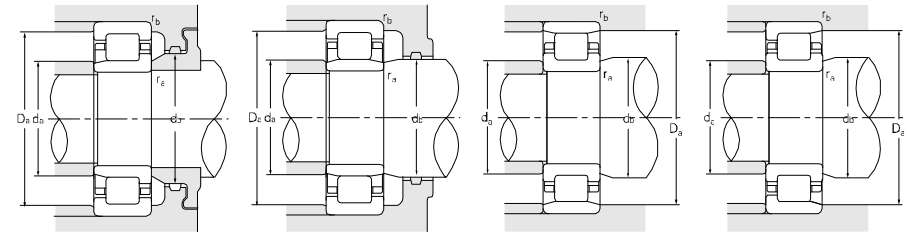
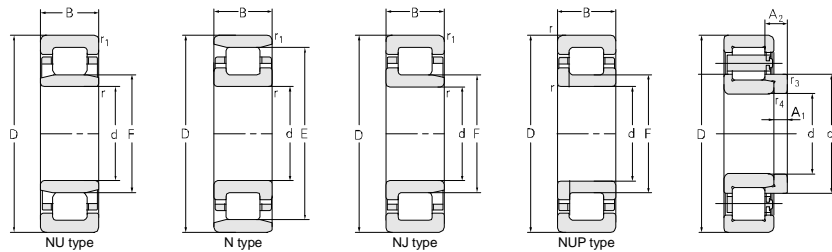

Principal dimensions						Basic load ratings		Limit speed ratings		Designations	
d	D	B	r _{1smin}	r _{smin}	F	E	C _r	C _{0r}	Grease		Oil
mm						kN		r/min			
320	580	190.5	5	5	390		3050	5480	900	1100	NU2264X2M
	580	150	5	5	377		3190	4720	900	1100	NUD2264M/YA8
	670	200	7.5	7.5	410		4590	7200	1100	1400	NU2364/HCR
	670	200	7.5	7.5	410		4150	6500	1100	1400	NU2364F1/HC
330	580	151	6	6	395		2750	4800	900	1100	NU666/HCYA8
340	420	48	2.1	2.1	361		490	1150	1150	1450	NJ2868M
	440	56	3	3	365		690	1380	1050	1350	NU1968X1M
	440	56	3	3	365		690	1380	1050	1350	NJ1968X1M
	460	56	3	3	370		700	1400	1050	1350	NU1968M
	460	72	3	3	373		785	1650	1050	1350	NU2968M
	520	82	5	5	385		1130	1910	1000	1300	NU1068M
	520	82	5	5	385		1130	1830	1000	1300	NJ1068M
	580	190	5	5	399		3300	5900	760	910	NU3168E
	580	190	5	5	400		3550	6650	760	910	NU3168
	580	200	5	5	400		3550	6650	760	910	NU3168WB
	580	190	5	5	399		3300	5900	760	910	NU3168EF3
	620	165	6	6	416		2950	4900	810	950	NU2268
	620	165	6	6	416		2950	4900	810	950	NU2268MA
	620	165	6	6	416		2950	4900	810	950	NU2268F3
	620	224	6	6	410		4600	8600	810	950	NU3268
	360	480	72	3	3	388		1220	2300	1100	1300
480		72	3	3	388		1110	2300	1100	1300	NF2972EM
480		72	3	3	388		1110	2300	1100	1300	NU2972E
480		90	3	3	388		1220	2590	1100	1300	NUP3972M/C9W33YA8
480		90	3	3	388		1220	2590	1100	1300	NUP3972M/C9W33
540		82	5	5	405	495	1180	2000	980	1280	N1072M/C9W33A
540		82	5	5	405		1190	2000	980	1280	NU1072MA
540		82	5	5	405		1190	2000	980	1280	NU1072M
540		82	5	5	405	499	1180	2000	980	1280	NF1072M
540		106	5	5	405		1890	3560	870	1050	NU2072M
540		134	5	5	405		2060	4050	800	1000	NU3072M
600		192	5	5	420		3520	6500	900	1000	NU3172

Abutment and fillet dimensions						Weight	Model	Weight	Separate thrust collar		
d _{amin}	d _{amax}	d _{bmin}	D _{amax}	D _{amin}	r _{amax}				r _{bmax}	A1	A2
mm						kg	kg	mm			
340	377	394	560		4	4	232				
340	377	394	560		4	4	151				
360	377	390	642		7	7	349				
360	377	390	642		7	7	349				
350	387	411	560		5	5	177				
350	357	372	410		2	2	15.5				
348	355	366	427		2.5	2.5	22.3				
					2.5	2.5	22.7				
353	365	374	447		2.5	2.5	28.3				
353	369	377	447		2.5	2.5	36.2				
360	380	389	500		4	4	65.0				
360	380	389	500		4	4	64.7				
360	388	403	560		4	4	211				
360	388	403	560		4	4	211				
360	388	403	560		4	4	213				
360	388	403	560		4	4	211				
366	401	421	594		5	5	229				
366	401	421	594		5	5	230				
366	401	421	594		5	5	229				
366	401	421	594		5	5	307				
380	400	380	464		2.5	2.5	38.1				
380	400	380	464		2.5	2.5	37.6				
380	400	380	464		2.5	2.5	37.4				
380		380	464		2.5	2.5	47.7				
380		380	464		2.5	2.5	51.3				
378		410	522	508	4	4	65.2				
378	400	410	522		4	4	66.2	HJ1072	7.7	21 39.03 5	
378	400	410	522		4	4	65.9	HJ1072	7.7	21 39.03 5	
378	400	410	522		4	4	67.7				
380	399	410	520		4	4	89.5				
381	400	410	520		4	4	112				
373	417		587	423	4	4	219				

Single-row Cylindrical Roller Bearing

d 360~400 mm

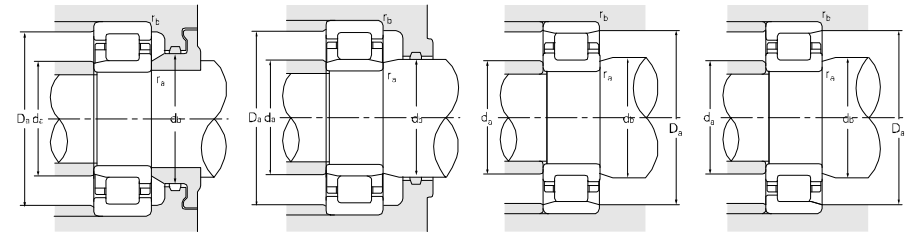
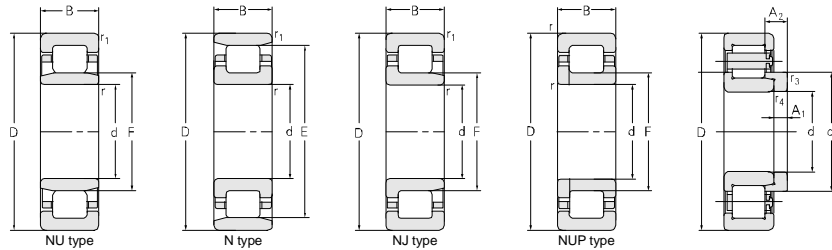

Principal dimensions						Basic load ratings		Limit speed ratings		Designations			
d	D	B	r _{1smin}	r _{smin}	F	E	C _r	C _{0r}	Grease		Oil		
mm						kN		r/min					
360	650	170	6	6	437		3150	5400	800	950	NU2272M NU3272M/HC NU2372 NUP2372M		
	650	232	6	6	435		4400	8050	800	950			
	750	224	7.5	7.5	455		5390	8650	700	850			
	750	224	7.5	7.5	455		4900	7600	700	850			
379.5	480	60	2.1	2.1	454		550	680	900	1180	N2876K/P69 N2876/P69 NUP2876K/P69		
	480	60	2.1	2.1	454		550	680	900	1180			
	480	60	2.1	2.1	406		550	680	900	1180			
380	480	60	2.1	2.1	406		550	680	900	1180	N2876/P69 NU1876M NUP1876M N2976M NU1076M NU2076EM NU3076EM NU2276EM NU2276MA NU2276MA/YA36 NU3276/HC		
	480	46	2.1	2.1	406		525	1050	950	1250			
	480	46	2.1	2.1	406		525	1050	950	1250			
	520	82	4	4			1180	2540	920	1200			
	560	82	5	5	425		1220	2090	950	1200			
	560	106	5	5	425		1930	3750	800	950			
	560	135	5	5	425		2250	4700	800	950			
	680	175	6	6	462		3050	5500	730	860			
	680	175	6	6	462		2860	5400	730	860			
	680	175	7.5	7.5	462		2860	5400	730	860			
	680	240	6	6	458		5860	9290	730	860			
	400	500	46	2.1	2.1	423		565	1150	980		1250	NU1880M NU3880Q1 NU1980M NU1980 NU2980EM FL-NJ2980/HCEC9 NU2980M NF2980M NUP1080M NU1080M NU1080MA NJ1080 NU2080EM NU3080M
		500	75	2.1	2.1	425		855	2010	980		1250	
540		65	4	4	435		900	1750	900	1150			
540		65	4	4	435		1000	1850	900	1150			
540		82	4	4	435		1350	2850	900	1150			
540		82	4	4	435		1340	2780	900	1150			
540		82	4	4	438		1250	2510	900	1150			
540		82	4	4	438		1250	2510	900	1150			
600		90	5	5	450	506	1450	2470	900	1100			
600		90	5	5	450		1450	2470	900	1100			
600		90	5	5	450		1330	2210	900	1100			
600		90	5	5	450		1450	2480	900	1100			
600		118	5	5	449		2150	4800	750	900			
600		148	5	5	450		2330	4550	900	1100			

Abutment and fillet dimensions						Weight	Model	Weight	Separate thrust collar		
damin	damax	dbmin	Damax	Damin	ramax				rbmax	A1	A2
mm						kg	kg	mm			
386	428	442	624		5	5	262				
381	400	410	520		5	5	352				
390	445	460	720		7	7	480				
390	445	460	720		7	7	513				
391		406	468	463	2	2	26.0				
391		406	468	463	2	2	25.9				
391		406	468		2	2	27.1				
390	401	410	470		2	2	25.9				
390	401	410	470		2	2	23.5				
390	401	410	470		2	2	24				
400	419	428	490		3	3	82.8				
400	420	430	540		4	4	71.0	HJ1076	8.48	21 39.03 5	
398	422	430	542		4	4	93				
398	417	430	542		4	4	116				
406	443	443	654		5	5	276				
406	443	443	654		5	5	289				
406	443	443	654		7	7	289				
406	435	435	654		5	5	383				
410	419	428	490		2	2	21.2				
410	419	428	490		2	2	33.4				
415	429	439	525		3	3	42				
415	429	439	525		3	3	41.7				
415	429	439	525		3	3	57.8				
415	429	439	525		3	3	56.2				
415	434	442	525		3	3	55.2				
415	434	442	525		3	3	52.6				
420	446	455	580		4	4	93.6				
420	446	455	580		4	4	92.5				
420	446	455	580		4	4	93				
420	446	472	580		4	4	90.6				
418	446	454	582		4	4	122				
420	446	455	580		4	4	153				

Single-row Cylindrical Roller Bearing

d 400~445 mm

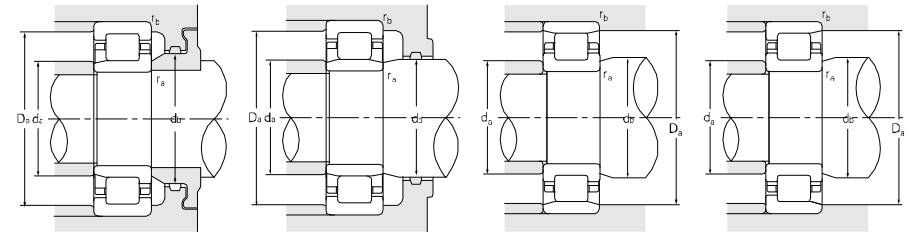
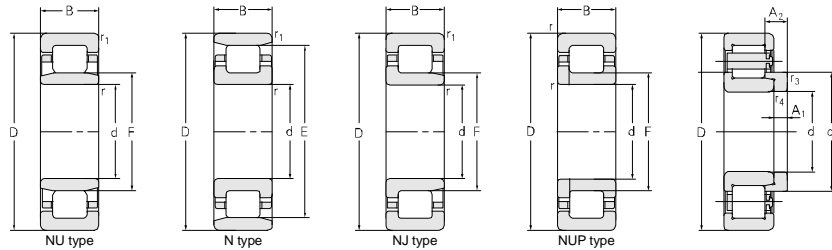

Principal dimensions						Basic load ratings		Limit speed ratings		Designations		
d	D	B	r _{1smin}	r _{smin}	F	E	C _r	C _{0r}	Grease		Oil	
mm						kN		r/min				
400	650	145	6	6	460		2920	5190	700	850	NU2180M	
	650	200	6	6	460		3760	7170	700	850	NU3180M	
406	502	76	2	2		481	1130	2660	1000	1200	NF6/406/C9W33	
406.362	501.688	76.2	3	3		481.33	1050	2550	1000	1200	N6/406X4M/C9W520	
420	520	46	2.1	2.1	447		605	1270	900	1100	NU1884	
	520	46		2.1	447		605	1270	900	1100	NUP1884	
	520	46	2.1	2.1	447		605	1270	900	1100	NU1884M	
	520	75	2.1	2.1	447		900	2250	930	1150	NJ3884M	
	560	65	4	4		528	1080	2010	930	1150	NF1984F3	
	560	65	4	4	449		1080	1950	930	1150	NJ1984MA	
	560	82	4	4	458		1290	2800	930	1150	NU2984M	
	560	82	4	4	458		1290	2800	930	1150	NJ2984	
	560	106	4	4	458		1550	3700	930	1150	NUP3984M/C9W33	
	580	130	4	4	468		1790	4660	930	1150	NU684ZWF1/C9YA3	
	620	90	5	5	470		1440	2490	900	1100	NU1084M/C3	
	620	118	5	5	469		2400	4750	770	950	NU2084EM	
	700	224	6	6	485		4950	8950	650	780	NU3184EM	
	760	280	7.5	7.5	507		6800	13400	560	700	NU3284X2/HCYA3	
	440	600	74	4	4	482		1010	1980	870	1050	NU1988M
600		74	4	4	482		1030	1900	870	1050	NJ1988M	
600		95	4	4	481.5		1670	3550	870	1050	NJ2988EM	
600		118	4	4	481.5		1940	4250	850	1000	NUP3988EM	
650		94	6	6	493		1570	2430	850	1000	NU1088M	
650		94	6	6	493		1570	2430	850	1000	NJ1088M	
650		122	6	6	487		2450	5000	670	820	NU2088EM	
720		122	6	6		648	2850	4300	800	950	N1188	
720		226	6	6	508		5230	9800	600	750	NU3188	
790		255	7.5	7.5	530		5760	10700	650	800	NU3288X2/HC	
445		815	210	7.5	7.5	539		4800	7950	750	1100	NU689M/C9

Abutment and fillet dimensions							Weight	Model	Weight	Separate thrust collar		
d _{amin}	d _{amax}	d _{bmin}	D _{amax}	D _{amin}	r _{amax}	r _{bmax}				A1	A2	r _{3,4}
mm							kg	kg	mm			
420	450	460	590		4	4	197					
420	450	460	590		4	4	274					
420			490	470	2	2	31.2					
418		432	491	489	2.5	2.5	34.1					
440	466	380	500		2	2	20.7					
440	466	380	500		2	2	23.7					
440	466	380	500		2	2	22.7					
427	441	462	510		2	2	33.3					
435	523		530	533	3	3	45.2					
435	442	466	545		3	3	46					
435	452	463	545		3	3	58.1					
435	452	463	545		3	3	59.5					
435		463	545		3	3	78.7					
435	452	463	567	558	3	3	110					
440	466	475	600		4	4	98.0					
438	466	474	602		4	4	127					
446	478	490	694		5	5	368					
446	478	490	730		6	6	577					
455	477	487	585		3	3	65					
455	477	487	585		3	3	61.4					
455	477	500	585		3	3	83.5					
455		483	585		3	3	106					
466	488	498	624		5	5	102	HJ1088	12.8	24	44.47 6	
466	488	498	624		5	5	106	HJ1088	12.8	24	44.47 6	
463	483	492	627		5	5	146					
466	488		690	670	5	5	207					
460	498	518	700		5	5	374					
468	498	510	762		6	6	583					
478	535	560	770		6	6	501					

Single-row Cylindrical Roller Bearing

d 452~480 mm

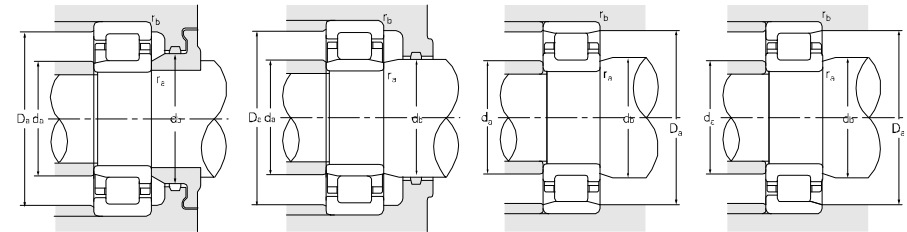
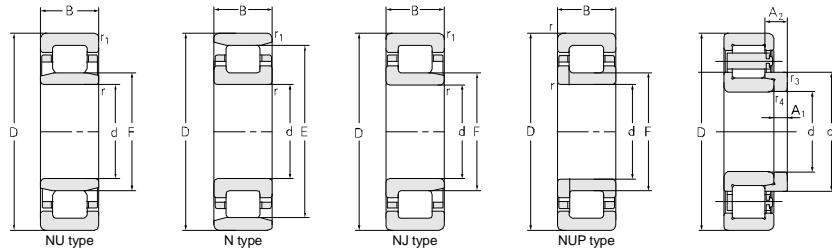

Principal dimensions						Basic load ratings		Limit speed ratings		Designations	
d	D	B	r _{1smin}	r _{smin}	F	E	C _r	C _{0r}	Grease		Oil
mm						kN		r/min			
452	680	100	6	6	516		1690	2630	600	750	NU10/452M/YB2
460	580	56	3	3		553	795	1720	800	950	N1892M
	580	56	3	3		553	840	1730	800	950	NF1892M
	580	56	3	3	489		840	1730	800	950	NJ1892M
	580	72	3	3	489		1030	2350	860	1050	NJ2892EM
	580	72	3	3	490		1090	2480	860	1050	FL-NJ2892/HCEC9
	620	95	4	4	502		1640	3500	800	950	NJ2992
	620	95	4	4	502		1670	1600	800	950	NUP2992
	620	95	4	4	502		1670	1600	800	950	NU2992
	620	118	4	4	502		1950	4400	800	950	NUP3992M/C9W33-1
	620	118	4	4	502		1950	4400	800	950	NUP3992M/C9W33
	680	100	6	6	516		1690	2630	800	950	NU1092M
	680	128	6	6	513		2700	5450	650	800	NU2092EM
	680	128	6	6	513		2450	4800	650	800	NU2092EMA
	680	128	6	6	516		2450	4800	650	800	NU2092MA
	680	163	6	6	516		2970	6150	650	790	NU3092M
	760	240	7.5	7.5	531		5450	10400	400	480	NU3192
	760	240	7.5	7.5	531		5450	10400	400	480	NU3192MA
	760	240	7.5	7.5	531		5310	10400	400	480	NU3192F3
	830	165	7.5	7.5	554		4200	6800	600	720	NU1292
	830	212	7.5	7.5	554		5700	10000	580	670	NU2292/HCYAD
	820	200	7.5	7.5	554		5650	9070	580	670	NU2292X3/HC
	830	212	7.5	7.5	554		4850	8000	580	670	NU2292M
	830	212	7.5	7.5	554		4850	8000	580	670	NU2292MA
	830	212	7.5	7.5	554		4850	8000	580	670	NU2292MA/HC
	830	212	7.5	7.5	554		4850	8000	580	670	NU2292MA-1
	830	212	7.5	7.5	554		4850	8000	580	670	NU2292MA/HCC9
480	600	56	3	3	511		750	1620	840	950	NU1896M
	600	56	3	3	511		785	1680	840	950	NU1896
	600	56	3	3	511		785	1680	840	950	NJ1896M
	600	72	3	3	509.5		1050	2400	840	950	NJ2896EM
	600	72	3	3	509.5		1140	2600	840	950	NJ2896EM
	650	78	5	5	525		1130	2200	780	920	NU1996/HCYA4

Abutment and fillet dimensions							Weight	Model	Weight	Separate thrust collar		
d _{amin}	d _{amax}	d _{bmin}	D _{amax}	D _{amin}	r _{amax}	r _{bmax}				A1	A2	r _{3,4}
mm							kg	kg	mm			
470	510	580	660		5	5	116	HJ10/452	15.1	25	47.47	6
473	548		567	558	2.5	2.5	37.2					
473	548		567	558	2.5	2.5	36.5					
473	480	503	567		2.5	2.5	36.3					
473	485	505	567		2.5	2.5	48.7					
473	485	505	567		2.5	2.5	46.1					
486	511	550	610		3	3	83.4					
480		524	600		3	3	85.0					
480		524	600		3	3	98.3					
476		510	604		3	3	107					
476		510	604		3	3	107					
486	511	521	654		5	5	111					
483	509	518	657		5	5	166					
483	509	518	657		5	5	164					
483	496	508	657		5	5	164					
483	496	508	657		5	5	211					
490	526	536	730		6	6	467					
490	526	536	730		6	6	481					
490	526	536	730		6	6	467					
492	542	559	798		6	6	405					
492	542	559	798		6	6	505					
492	542	559	798		6	6	505					
492	542	559	798		6	6	515					
492	542	559	798		6	6	518					
492	542	559	798		6	6	518					
492	542	559	798		6	6	518					
492	542	559	798		6	6	518					
439	507	516	587		2.5	2.5	37.5					
439	507	516	587		2.5	2.5	36.3					
439	507	516	587		2.5	2.5	37.4					
493	504	524	587		2.5	2.5	46.5					
493	504	524	587		2.5	2.5	49.0					
498	517	530	632		4	4	74.3					

Single-row Cylindrical Roller Bearing

d 480~530 mm

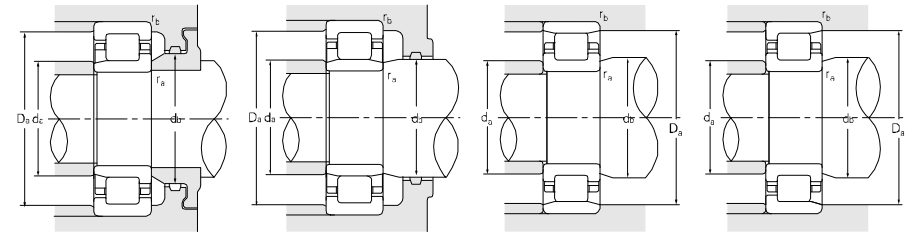
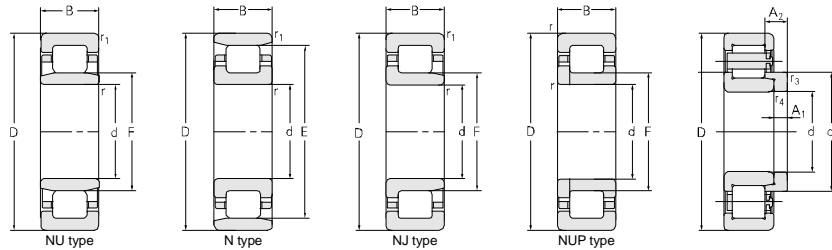

Principal dimensions	Basic load ratings						Limit speed ratings		Designations	
	d	D	B	r _{1smin}	r _{smin}	F	E	C _r		C _{0r}
mm	kN						r/min			
480	700	100	6	6	536	1600	2970	720	860	NU1096M
	700	100	6	6	536	1900	3500	720	860	NU1096MA
	700	128	6	6	536	2600	5250	600	720	NU2096MA
	790	248	7.5	7.5	547	5650	10700	500	600	NU3196EM
	790	248	7.5	7.5	556	5700	11000	500	600	NU3196M
488.95	660.4	149.225	5	5	532	2350	5480	600	750	NU6/488X4/W33X
500	620	56	3	3		592	795	1700	780	NF18/500EM
	620	72	3	3	530	1130	2670	780	940	NU28/500EM
	670	78	5	5	544	1160	2350	720	880	NU19/500EM
	670	100	5	5	543	1930	4300	750	900	NU29/500
	670	100	5	5	543	1860	4100	750	900	NJ29/500
	670	100	5	5	543	1940	4300	750	900	NU29/500F3
	670	100	5	5		1860	4100	750	900	N29/500
	670	128	5	5	543	2300	5350	670	840	NUP39/500M/C9W33-1
	670	128	5	5	543	2400	5700	670	840	NUP39/500M/C9W33
	670	128	5	5		2250	5150	670	840	N39/500EM
	720	100	6	6	556	1680	3050	720	880	NJ10/500
	720	128	6	6	553	2850	5900	620	720	NU20/500EM
	720	167	6	6	556	3210	6970	620	720	NU30/500
	830	264	7.5	7.5	581	6250	12200	480	580	NU31/500
	830	264	7.5	7.5	581	7500	12200	480	580	NU31/500/HCC9YA3
	900	210	7.5	7.5	600	6500	11800	540	600	NU12/500X3/HC
	900	210	7.5	7.5	600	6500	11800	540	600	NU12/500X3/HCYB2
	920	185	7.5	7.5	603.1	5050	8450	540	650	NU12/500M
	920	185	7.5	7.5	603.1	5800	9800	540	650	NU12/500/HCEC9
508	622.3	95.25	4	4	538	1360	3430	740	850	NUP6/508Q1/C9
530	650	72	3	3		622	1170	2890	900	NF28/530
	650	72	3	3	562	1160	2890	900	1100	NJ28/530
	710	82	5	5	573	1500	2980	680	830	NJ19/530EM
	710	106	5	5	580	2000	4600	400	500	NUP29/530
	710	106	5	5	580	2000	4600	400	500	NUP29/530F3
	710	106	5	5	580	1990	4550	400	500	NU29/530/YA1

Abutment and fillet dimensions						Weight	Model	Weight	Separate thrust collar		
d _{amin}	d _{amax}	d _{bmin}	D _{amax}	D _{amin}	r _{amax}				r _{bmax}	A1	A2
mm	kg						kg	mm			
503	531	538	677		5	5	128				
503	531	538	677		5	5	129				
503	529	538	677		5	5	176				
512	536	552	758		6	6	495				
512	545	561	767		6	6	508				
507	517		640		4	4	153				
513			607	598	2.5	2.5	38.5				
513	526	534	607		2.5	2.5	48.5				
518	537	549	652		4	4	80				
522	537	549	648		3	3	101				
522	537	549	648		3	3	105				
522	537	549	648		3	3	102				
519	537		648		3	3	103				
522		549	648		3	3	137				
522		549	648		3	3	137				
518	627	638	652		4	4	128				
523	550		697		5	5	136				
523	549	558	697		5	5	175				
523	530	545	697		5	5	232				
532	550	580	798		6	6	602				
					6	6	602				
					6	6	606				
532	593	610	868		6	6	606				
532	593	610	868		6	6	606				
532	593	610	888		6	6	585				
532	593	610	888		6	6	572				
520	526	534	607		3	3	65.6				
544			645	625	2.5	2.5	52.2				
544			645	625	2.5	2.5	54.4				
548	568	598	692		4	4	94.5				
555		605	585		4	4	125				
555		605	585		4	4	125				
555	585	605	585		4	4	125	HJ29/530	13.2	24 41.42 5	

Single-row Cylindrical Roller Bearing

d 530~600 mm

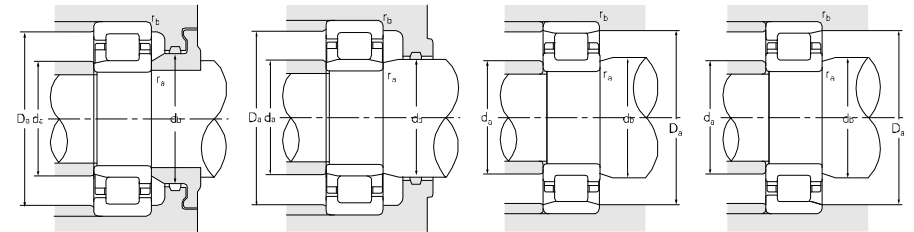
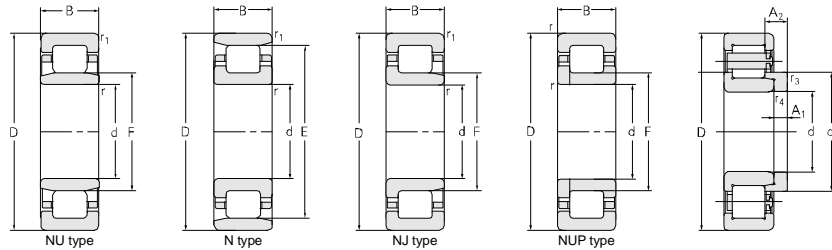

Principal dimensions						Basic load ratings		Limit speed ratings		Designations	
d	D	B	r _{1smin}	r _{smin}	F	E	C _r	C _{Or}	Grease		Oil
mm						kN		r/min			
530	710	106	5	5	580		2000	4800	400	500	NU29/530F3
	780	112	6	6	593		2200	4050	650	780	NU10/530M
	780	145	6	6	591		3650	7360	550	650	NU20/530EM
	870	272	7.5	7.5	612		7250	14500	460	550	NU31/530EM
	870	272	7.5	7.5	612		7500	13500	460	550	NU31/530/HCE
	870	272	7.5	7.5	612		7000	13500	460	550	NU31/530
	870	272	7.5	7.5	612		6900	13500	460	550	NU31/530/HG2
870	272	7.5	7.5	612		7500	13500	460	550	NU31/530/HCYA6	
558.8	685.8	100		5	590.5		1680	4450	670	820	NUP6/558.8Q1/C9-NJB
560	680	56	3	3	591		810	1830	670	820	NJ18/560M
	680	56	3	3	591		810	1830	670	820	NJ18/560MA
	680	72	3	3		651	1170	2950	670	820	NF28/560
	750	85	5	5	608		1630	3200	650	780	NU19/560EM
	750	85	5	5	608		1660	3250	650	780	NJ19/560
	750	85	5	5	608		1660	3250	650	780	NJ19/560MA
	750	112	5	5	607		2400	5450	650	780	NJ29/560
	750	112	5	5	607		2400	5450	650	780	NJ29/560F3
	750	112	5	5		703	2420	5600	650	780	N29/560
	750	112	5	5	607		2470	5570	650	780	FL-NU29/560/C3
	820	115	6	6	625		2250	4200	620	720	NU10/560M
	820	150	6	6	626		3650	7600	500	600	NU20/560EM
	960	270	9.5	9.5	670		8900	17000	480	550	NU6/560/HC
	1030206		9.5	9.5	668		6850	11000	460	550	NU12/560MA
600	730	60	3	3	632		860	2000	650	780	NU18/600EM
	730	78	3	3	632		1250	3350	620	730	NU28/600EM
	800	90	5	5	649		1900	3800	620	750	NU19/600EM
	800	90	5	5	649		1860	3600	620	750	NU19/600
	800	90	5	5	649		1900	3800	620	750	NUP19/600EM
	800	90	5	5		757	1900	3800	620	750	NF19/600EM
	800	90	5	5	649		1860	3600	620	750	NJ19/600M
	800	118	5	5	649		2900	6550	620	750	NU29/600E
	830	150	5	5	655		3410	7450	600	700	NU6/600

Abutment and fillet dimensions						Weight	Model	Weight	Separate thrust collar			
d _{amin}	d _{amax}	d _{bmin}	D _{amax}	D _{amin}	r _{amax}				r _{bmax}	A1	A2	r _{3,4}
mm						kg	kg	mm				
555	585	605	585		4	4	125	HJ29/530	13.2	24	41.42	5
553	585	598	757		5	5	187					
553	587	596	757		5	5	252					
562	605	617	838		6	6	663					
562	605	617	838		6	6	670					
562	605	617	838		6	6	670					
562	605	617	838		6	6	670					
562	605	617	838		6	6	670					
573	584	590	667		4	4	82.9					
573	584	606	667		2.5	2.5	42.5					
573	584	606	667		2.5	2.5	44.2					
573	645	665	657	657	2.5	2.5	53					
578	600	613	732		4	4	108					
578	600	613	732		4	4	111					
578	600	613	732		4	4	111					
586	620	693	724		4	4	148					
586	620	693	724		4	4	148					
586	620	693	724	713	4	4	138					
586	620	693	724		4	4	146					
583	617	630	797		5	5	215					
583	616	631	797		5	5	289					
588	630	646	932		8	8	846					
600	657	674	990		8	8	809					
613	625	637	717		2.5	2.5	49.3					
613	625	637	717		2.5	2.5	68.5					
618	642	645	782		4	4	128					
618	642	645	782		4	4	128					
618	642	645	782		4	4	135					
618	642	645	782		4	4	130					
619	642	657	782		4	4	130					
618	642	675	782		4	4	163					
619	647	703	806		4	4	237					

Single-row Cylindrical Roller Bearing

d 600~660.4 mm

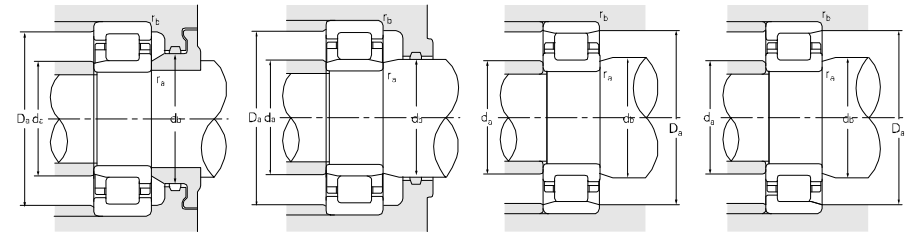
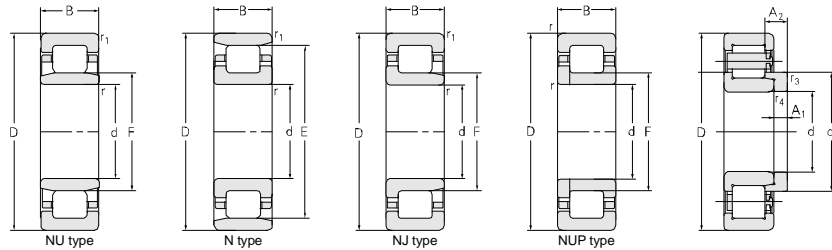

Principal dimensions	Basic load ratings						Limit speed ratings		Designations		
	d	D	B	r _{1smin}	r _{smin}	F	E	C _r		C _{0r}	Grease
mm	kN						r/min				
600	870	118	6	6	667	2840	5250	590	680	NU10/600	
	870	155	6	6	661	4180	8000	500	600	NU20/600EM	
	870	200	6	6	661	5390	11000	500	600	NU30/600E	
	870	200	6	6	661	5400	11000	500	600	NU30/600F3/HCYA4	
	1090	155	9.5	9.5	740	5100	8400	500	600	NU2/600MA/HC	
	1090	155	9.5	9.5	740	5100	8400	500	600	NU2/600M/YB2	
620	780	102	4	4	7 4	1950	4800	600	750	NFP6/620Q1	
	780	102	4	4	0	1950	4800	600	750	N620/780	
630	780	88	4	4	0	1800	4500	630	750	N28/630M	
	780	88	4	4	668	1800	4500	630	750	NU28/630M	
	780	112	4	4	7 4	2150	5750	550	650	N38/630M	
	780	112	4	4	4	2150	5750	550	650	NF38/630M	
	850	100	6	6	688	1980	4000	600	700	NU19/630M	
	850	100	6	6	688	7 4	1980	4000	600	700	NJ19/630
	850	100	6	6	683	5	2150	4250	600	700	NU19/630EM
	850	128	6	6	688	7 4	3050	6950	580	680	NU29/630
	850	128	6	6	683	5	3250	7250	580	680	NU29/630EM
	850	128	6	6	683	5	3250	7250	580	680	NJ29/630EM
	920	128	7.5	7.5	702	3400	6250	450	530	NU10/630EM	
	920	128	7.5	7.5	702	3400	6250	450	530	NUP10/630EM	
	920	170	7.5	7.5	699	4700	9500	480	560	NU20/630EM	
920	170	7.5	7.5	699	4650	9150	480	560	NU20/630EM		
920	170	7.5	7.5	699	4650	9150	480	560	NU20/630MA		
920	212	7.5	7.5	699	6450	14500	450	530	NU30/630		
640	960	140	7.5	7.5	710	4370	7900	400	480	NJFP6/640K/HCC3	
660.4	812.8	107.95	4	4	697	2280	6000	560	670	NUP6/660.4Q1/C9-1	
	863.6	107.95	5.1	5.1	704	3000	6050	560	670	NUP6/660.4Q1/C9	
	863.6	107.95	5.1	5.1	704	3000	6050	560	670	NUP6/660.4Q1/C9-LS	
	863.6	107.95	5.1	5.1	704	3000	6050	560	670	NUP6/660.4Q1/C91-NJB	
	863.6	107.95	5.1	5.1	704	3000	6050	560	670		

Abutment and fillet dimensions						Weight	Model	Weight	Separate thrust collar		
d _{amin}	d _{amax}	d _{bmin}	D _{amax}	D _{amin}	r _{amax}				r _{bmax}	A1	A2
mm	kg						kg	mm			
623	658	672	847	5	5	234					
623	652	667	847	5	5	320					
623	655	666	847	5	5	412					
623	655	666	847	5	5	416					
623	655	666	1062	8	8	686	HJ2/600	54.4	30	54.67 9.5	
623	655	666	1062	8	8	676	HJ2/600	54.4	30	54.67 9.5	
654	680	695	765	3	3	124					
654	680	695	765	3	3	124					
645	737		765	744	3	95.6					
645	660	674	765	3	3	96					
645	739		765	744	3	118					
645	739		765	744	3	120					
653	681	694	827	5	5	158					
653	681	694	827	5	5	167					
653	676	688	827	5	5	160					
653	678	689	827	5	5	210					
653	678	689	827	5	5	214					
653	678	689	827	5	5	222					
658	691	706	892	6	6	284					
658	691	706	892	6	6	284					
658	690	705	892	6	6	395					
658	690	705	892	6	6	399					
658	690	705	892	6	6	399					
658	690	705	892	6	6	485					
655	670		952	6	6	345					
680		734	843	4	4	127					
680		734	843	4	4	179					
680		734	843	4	4	170					
680		734	843	4	4	170					

Single-row Cylindrical Roller Bearing

d 666.75~723.8 mm

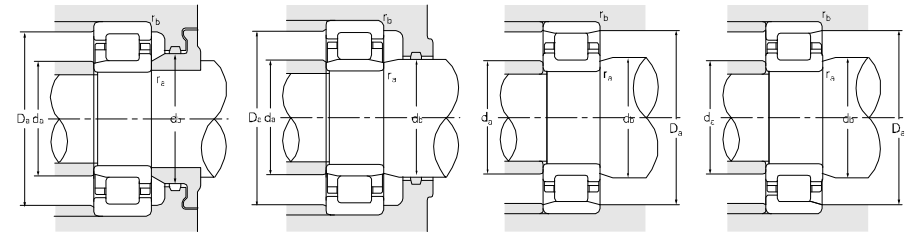
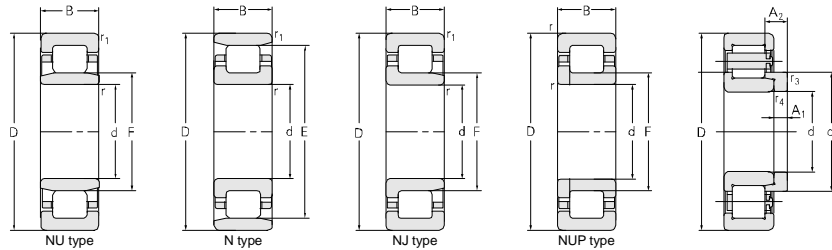

Principal dimensions						Basic load ratings		Limit speed ratings		Designations		
d	D	B	r _{1smin}	r _{smin}	F	E	C _r	C _{0r}	Grease		Oil	
mm						kN		r/min				
666.75	838.2	114.3	3	6			796	2870	6850	560	680	NFP6/666X4Q1/C9 NFP6/666X4Q1/C91-LS NFP6/666X4Q1/C9-LS
	838.2	114.3	3	6			796	2870	6850	560	680	
	838.2	114.3	3	6			796	2870	6850	560	680	
670	820	69	4	4	708		786	1230	2800	550	650	NJ18/670 NF18/670 NJ38/670Q1 NFP38/670Q1/C9YAD NUP19/670 NU19/670 NU10/670 NU20/670E N30/670 NU30/670M
	820	69	4	4			786	1450	3350	550	650	
	820	112	4	4	706			2570	7000	560	670	
	820	112	4	4			786	2490	6700	560	670	
	900	103		6	731			2420	4900	530	630	
	900	103		6	731			2420	4900	530	630	
	980	136		7.5	747			3700	6800	430	500	
	980	180		7.5	746			5400	11500	430	500	
	980	230		7.5	744		914	6930	15000	430	500	
	980	230		7.5	744			6500	14500	430	500	
700	930	160	6	6	760			3520	8500	500	600	NU6/700 NU6/700M NU6/700F3 NUP6/700 NUP6/700F3
	930	160	6	6	760			3200	8520	500	600	
	930	160	6	6	760			3520	8500	500	600	
	930	160		6	760			3520	8500	500	600	
	930	160		6	760			3520	8500	500	600	
710	870	74	4	4			830	1450	3370	500	600	N8/710/HC NF280/710 N28/710X3/W33 N19/710F3/CNL NF19/710F3 NU19/710 NU29/710EM NU29/710M NU10/710EM NU20/710EM NU11/710X2
	870	95	4	4			831	1880	4950	480	560	
	900	106	4	4			845	1800	5200	480	560	
	950	106	6	6			884	2450	6000	480	560	
	950	106	6	6			884	2450	6000	480	560	
	950	106	6	6	770			2590	5500	480	560	
	950	140	6	6	766			3650	8250	480	560	
	950	140	6	6	776			3000	7000	480	560	
	1030	140		7.5	778			4550	8400	420	490	
	1030	185		7.5	787			5800	12000	420	490	
	1150	185		9.5	835			5900	11700	400	450	
711.2	863.6	107.95		6.35	743			3300	6700	500	600	NUP6/711.2M/C9
723.8	908.05	120.65	5	5			865	3350	8300	480	550	NFP6/723.8Q1/C9

Abutment and fillet dimensions						Weight	Model	Weight	Separate thrust collar			
d _{amin}	d _{amax}	d _{bmin}	D _{amax}	D _{amin}	r _{amax}				r _{bmax}	A1	A2	r _{3,r4}
mm						kg	kg	mm				
682	790		820	812	5	3	160					
682	790		820	812	5	3	158					
682	790		820	812	5	3	158					
654	700	727	805		3	3	83.8					
654	698	712	805	797	3	3	85.8					
640	700	727	805		3	3	133	HJ38/670	7.8	15	25	4
640	780		800	792	3	3	133					
693	730	755	877		5	5	193					
693	730	755	877		5	5	193					
698	736	753	952		6	6	344					
698	736	752	952		6	6	477					
	908		952	919	6	6	594					
698	736	750	952		6	6	596					
733	760	772	900		5	5	306					
733	760	772	900		5	5	309					
733	760	772	900		5	5	306					
733		772	900		5	5	316					
733		772	900		5	5	316					
725			855	835	3	3	102					
725	825		855	835	3	3	126					
740	755		880	850	3	3	168					
740	875		910	890	5	5	227					
740	875		910	890	5	5	229					
740	755		900		5	5	210					
733	760	772	927		5	5	294					
733	760	772	927		5	5	291					
738	769	783	1002		6	6	420					
738	780	793	1002		6	6	535					
743	790	815	1116		9	9	874	HJ11/710	67.7	35	62	9.5
740	750	800	835		5	5	136					
752	765		883	850	4	4	197					

Single-row Cylindrical Roller Bearing

d 750~900 mm

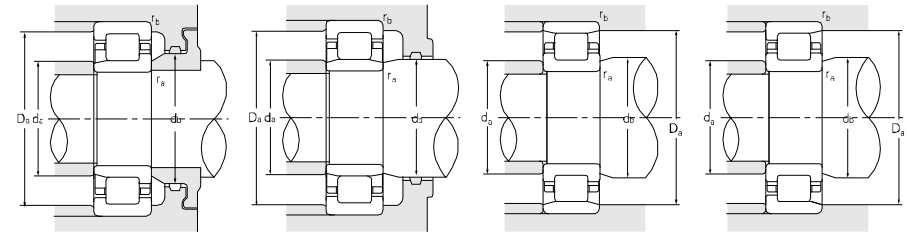
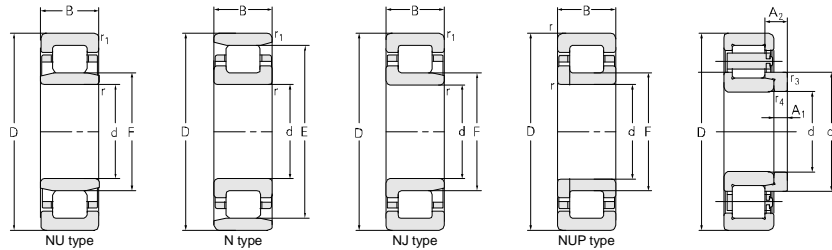

	Principal dimensions						Basic load ratings		Limit speed ratings		Designations
	d	D	B	r _{1smin}	r _{smin}	F	E	C _r	C _{0r}	Grease	
	mm						kN		r/min		
750	920	78	5	5	794		1450	3500	480	590	NU18/750M
	920	78	5	5		880	1510	3480	480	590	NF18/750M
	920	78	5	5		880	1510	3480	480	590	NF18/750F3
	920	100	5	5		880	2160	5500	480	590	N28/750
	920	100	5	5		880	2160	5500	480	590	N28/750F3
	920	120	5	5		880	2690	7300	480	590	N38/750X2M
	1000	100	6	6	815		3030	6500	460	550	NU19/750X2/C9
	1000	112	6	6		943	2750	5750	470	550	NF19/750EM
	1000	112	6	6	815		2660	5500	470	550	NUP19/750
	1090	150	7.5	7.5	830		4500	8500	350	415	NU10/750EM
	1090	195	7.5	7.5	832		6700	14500	350	415	NU20/750EM
	1320	185	6	6	895		8200	14100	320	400	NU2/750X3
800	980	82	5	5		936	1690	4000	430	510	NF18/800
	980	82	5	5	846		1700	4200	430	510	NJ18/800EM
	1060	115	6	6	870		2880	6150	400	450	NU19/800
	1150	155	7.5	7.5	883		5400	10500	320	380	NU10/800EM
	1150	200	7.5	7.5	882		6900	14500	320	380	NU20/800EM
	1150	200	7.5	7.5	885		7910	14600	320	380	NU20/800MA/HC
812.8	1016	139.7		6	865		4150	10500	420	500	NUP6/812X4
820	990	72	5	5		943	1180	2960	450	530	N6/820
850	1030	106	5	5	902		2050	5900	410	480	NU28/850M
	1030	106	5	5	902		2050	6490	410	480	NU28/850MB
	1030	106	5	5	902		2250	6500	410	480	NJ28/850M
	1030	106	5	5		982	2250	6490	410	480	N28/850MB
	1120	118	6	6	919		3050	6900	390	460	NU19/850EM
	1120	118	6	6	919		2930	7000	390	460	NJ19/850
	1220	212	7.5	7.5	935		7300	15400	390	460	NU20/850EM/HC
900	1090	85	5	5	949		1900	4850	370	440	NU18/900M
	1090	112	5	5	949		2650	7150	370	440	NU28/900M

Abutment and fillet dimensions								Weight	Model	Weight	Separate thrust collar			
d _{amin}	d _{amax}	d _{bmin}	D _{amax}	D _{amin}	r _{amax}	r _{bmax}	A1				A2	r _{3,4}		
mm								kg	kg	mm				
770	784	800	900		4	4		105						
770	784	800	900		4	4		102						
773	875		900	885	5	5		101						
773	875		900	885	5	5		145						
773	875		900	885	5	5		145						
773	875		900	885	5	5		176						
733	750	770	977		5	5		220						
773	938		977	953	5	5		264						
733		770	977		5	5		252						
778	823	838	1062		6	6		492						
778	823	838	1062		6	6		634						
773	820	876	1296		5	5		1105	HJ750	115	40	70	6	
818	930		950	942	5	5		133						
818	838	866	962		4	4		144						
824	838	856	1036		5	5		279						
828	869	889	1122		6	6		565						
828	868	888	1122		6	6		710						
828	868	888	1122		6	6		725						
830	860	880	986		5	5		277						
840	937		970	944	4	4		128						
868	891	908	1012		4	4		192						
868	891	908	1012		4	4		192						
868	891	908	1012		4	4		191						
868	891		1010	994	4	4		187						
873	909	926	1097		5	5		325						
873	909	926	1097		5	5		326						
878	981	912	1192		6	6		835						
918	942	956	1072		4	4		172						
918	944	956	1072		4	4		234						

Single-row Cylindrical Roller Bearing

d 900~1250 mm

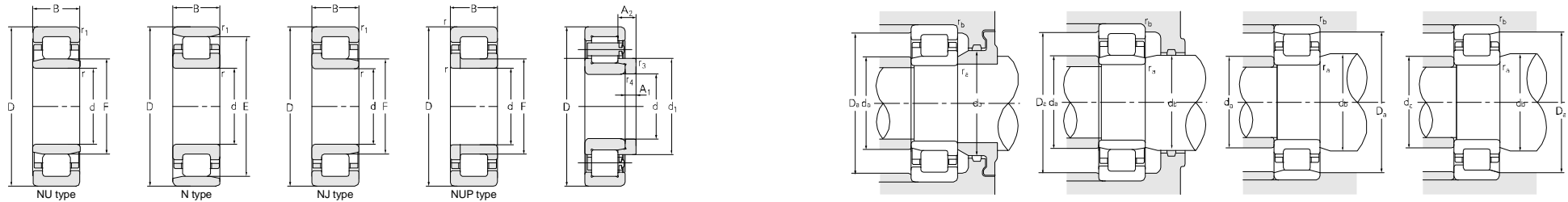

Principal dimensions						Basic load ratings		Limit speed ratings		Designations	
d	D	B	r _{1smin}	r _{smin}	F	E	C _r	C _{Or}	Grease		Oil
mm						kN		r/min			
900	1090	112	5	5			10452700	7250	370	440	NF28/900
	1090	140	5	5	945		3300	9100	350	420	NU38/900
	1180	122	6	6	966.5		4050	8700	350	420	NU19/900EM
	1180	165	6	6	969		5750	13500	350	420	NU29/900EM
	1200	150	6	6			11244450	10200	350	420	N6/900
950	1250	175	7.5	7.5	1024		5560	13000	340	400	NU29/950
	1250	175		7.5	1024		5670	13400	140	170	NUP29/950
	1250	175	7.5	7.5	1024		5560	13000	340	400	NU29/950F3
1000	1220	100	6	6	1053		2650	6550	350	420	NU18/1000M
	1220	100	6	6	1053		2650	6550	350	420	NJ18/1000M
	1220	128	6	6	1053		3600	9500	350	420	NJ28/1000EM
	1320	185	7.5	7.5	1082		6700	17000	290	350	NU29/1000E
1060	1280	128	6	6			12253550	10500	310	370	N28/1060M
	1400	150	7.5	7.5	1148		5280	12100	290	350	NU19/1060M
	1400	195	7.5	7.5	1146		7200	17000	290	350	NU29/1060EM
	1400	250	7.5	7.5	1146		9000	23500	250	310	NU39/1060EM
	1500	325	9.5	9.5			139012500	32500	230	290	N30/1060
1120	1360	106	6	6	1182		3350	8600	270	330	NJ18/1120EM
	1360	106	6	6	1185		3250	8550	270	330	NJ18/1120F3/W20
	1360	106	6	6	1185		3250	8550	270	330	NJ18/1120F3/W20YB2
	1360	106	6	6	1185		3250	8550	270	330	NJ18/1120M
1180	1420	106	6	6	1242		2950	7750	250	320	NJ18/1180EM
	1420	106	6	6	1242		3050	8000	250	320	NJ18/1180M
	1540	206	7.5	7.5	1258		8950	21500	180	220	NU29/1180EM
	1540	272	7.5	7.5			146611000	28500	190	250	N39/1180M
1200	1520	185	7.5	7.5	1289		6220	17000	110	140	NU6/1200/C91
	1520	185	7.5	7.5	1289		6220	17000	110	140	NU6/1200/C9
	1520	185	7.5	7.5			14396240	17000	110	140	FL-N6/1200/YAD
1250	1500	112	6	6	1316		3630	9550	300	380	NU18/1250C9

Abutment and fillet dimensions						Weight	Model	Weight	Separate thrust collar		
d _{amin}	d _{amax}	d _{bmin}	D _{amax}	D _{amin}	r _{amax}				r _{bmax}	A1	A2
mm						kg	kg	mm			
918	944	956	1072		4	4	228				
918		956	1072		4	4	268				
923	957	973	1157		5	5	378				
923	958	975	1157		5	5	565				
923	985		1165		5	5	485				
978	1013	1013	1222		6	6	596				
990		1069	1210		6	6	616				
978	1013	1013	1222		6	6	596				
1023	1040	1060	1197		5	5	264				
1023		1060	1197		5	5	252				
1023	1040	1082	1197		5	5	345				
1028	1072	1089	1292		6	6	705				
1083	1218		1257	1230	5	5	355				
1088	1010	1133			6	6	653				
1028	1133	1152	1372		6	6	875				
1028	1140	1153	1372		6	6	1060				
1094	1382		1466	1402	8	8	1880				
1143	1175	1210	1337		5	5	330				
1143	1175	1210	1337		5	5	327				
1143	1175	1210	1337		5	5	329				
1143	1175	1210	1337		5	5	329				
1203	1228	1270	1397		5	5	354				
1203	1228	1270	1397		5	5	340				
1208	1250	1266	1512		6	6	1046				
1208	1458		1512	1474	6	6	1350				
1240	1274	1304	1480		6	6	825				
1240	1274	1304	1480		6	6	825				
1240	1274		1480		6	6	838				
1280	1306	1326	1470		5	5	386				

Single-row Cylindrical Roller Bearing

d 1250~1900 mm

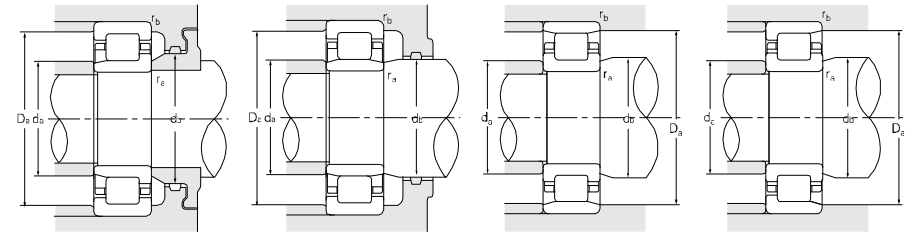
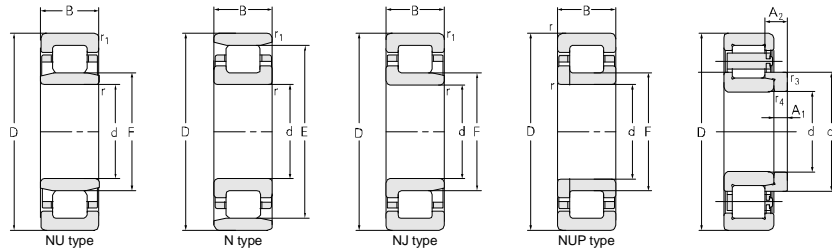

Principal dimensions						Basic load ratings		Limit speed ratings		Designations	
d	D	B	r _{1smin}	r _{smin}	F	E	C _r	C _{0r}	Grease		Oil
mm							kN				r/min
1250	1500	112	6	6	1316		3630	9550	300	380	NU18/1250F3/C9
	1500	145	6	6	1316		4900	14000	300	380	NU18/1250/HCE
	1750	290	9.5	9.5		1635	12500	29500	165	190	N20/1250M
1320	1600	122	6	6	1395		3650	9500	190	250	NU18/1320M
	1640	185	7.5	15	1040		6520	17730	190	250	FL-NU6/1320
	1720	175	7.5	7.5	1425		7920	19500	190	240	NU19/1320
	1720	175	7.5	7.5	1475		6700	16200			NU19/1320D/HCRYAD
	1720	230	7.5	7.5	1420		10900	29000	180	230	NU29/1320E
	1720	300	7.5	7.5		1640	12600	32500	175	210	N39/1320M
1400	1700	175	7.5	7.5		1637	6300	1750	175	210	N28/1400EM
1500	1770	160	4	7.5	1580		5700	19200	200	260	NU6/1500/HCC9YA34
	1820	140	7.5	7.5	1585		6220	17300	195	250	NU18/1500/HC
	1820	140	7.5	7.5		1735	6220	17300	195	250	NF18/1500/HC
1600	1950	155	7.5	7.5		1857	6560	18300	150	185	FL-N18/1600
	1950	200	7.5	7.5	1690		8340	24300	150	185	NU28/1600F3
1700	2060	160	7.5	7.5	1784		6950	18500	125	155	NU18/1700EM
1900	2300	175	9.5	9.5		2204	8150	23700	90	115	N18/1900

Abutment and fillet dimensions						Weight	Model	Weight	Separate thrust collar		
d _{amin}	d _{amax}	d _{bmin}	D _{amax}	D _{amin}	r _{amax}				r _{bmax}	A1	A2
mm							kg	kg	mm		
1280	1306	1326	1470		5	5	386				
1280	1306	1326	1470		5	5	517				
1284	1625		1716	1650	8	8	2310				
1343	1382	1403	1577		5	5	525				
1364	1376	1382	1610		6	6	893				
1348	1406	1428	1692		6	6	1110				
1348	1460	1478	1692		6	6	1080				
1348	1405	1430	1692		6	6	1510				
1348	1630		1692	1655	6	6	1890				
1362	1727		1803	1747	10	10	3540				
1428	1627		1672	1647	6	6	858				
1528	1570		1742				730				
1528	1570	1748	1792		6	6	773				
1528	1728		1792	1745	6	6	773				
1630	1680	1700	1886	1876	6	6	1030				
1655	1680	1700	1886		6	6	1272				
1728	1771	1795	2032		6	6	1156				
1934	2194		2266	2219	8	8	1480				

Full Complement Single-row Cylindrical Roller Bearing

d 25-40 mm

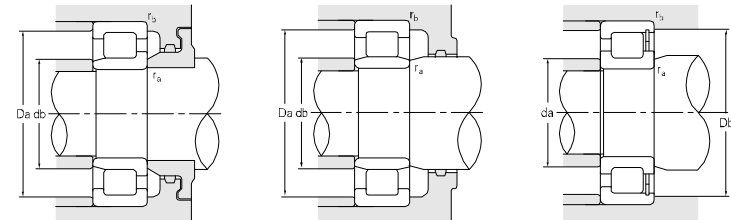
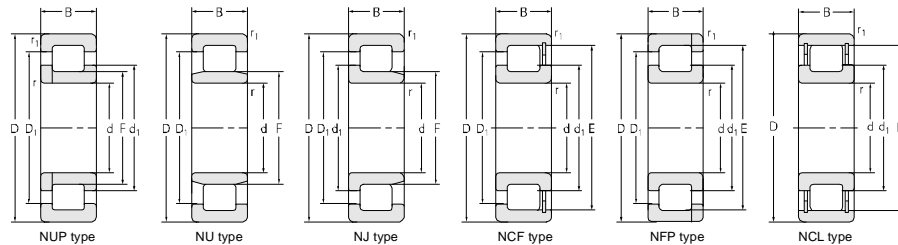

Principal dimensions				Basic load ratings			Limit speed ratings			
d	D	B	r _{1min}	r _{min}	F, E	C _r	C _{or}	Grease	Oil	
						kN	r/min			
mm										
25	52	18	0.5	0.7	31	46.2	51.0	11000	13600	
	52	18	1	1.1	31	41.3	43.5	11000	13600	
	52	18	1	0.3	31	43.5	48	11000	13600	
	52	18	1	0.5	30.998	35	35	11000	13600	
	62	20	1.1	3	34	56	60.5	9820	12100	
	62	24	1.1	3	34	63.0	74.5	9820	12100	
	62	24	1.1	1.1	34.35	69.0	66.0	9820	12100	
30	62	19	1	2	38.2	52.0	58.5	9310	11470	
	72	19	2.0	2.0	40.4	80.0	60.5	8430	10400	
	72	21	1.1	1.1	38.5	80.0	68.5	8430	10400	
	72	30.162	1.0	1.5	60.409	275	445	8430	10400	
	80	21	1.1	2.5	43.8	85.0	86.5	7500	9200	
35	80	21	1.5	1.5	46.2	103	89.0	7500	9200	
	80	21	1.5	0.5	46.2	103	89.0	7500	9200	
	80	21	1.5	1.5	46.2	103	89.0	7500	9200	
	80	21	1.5	3.0	46.2	103	89.0	7500	9200	
	80	21	1.1	1.5	45.806	103	106	7500	9200	
	80	23	1.5	3.5	45.8	69	48.0	7500	9200	
	82	23	1.1	1.1	64.5	79.0	112	7500	9200	
	90	23	2	5	49.7	96.0	102	7170	8840	
	90	23	2	5	49.7	96.0	102	7170	8840	
	90	23	2.5	1	49	112	95.0	7170	8840	
	90	23	5	1.5	48.5	112	83.5	7170	8840	
	90	23	1.5	1.5	47.88	99.5	98	7170	8840	
	90	23	2	1.5	49.7	96	102	7170	8840	
	90	23	1.5	2.1	47.88	99.5	98.0	7170	8840	
	90	29	1.5	1.5	48	113	131	7170	8840	
90	29	1.5	0.5	48	124	131	7170	8840		
40	80	31	1.5	3.5	49	114	140	7170	8840	
	90	23	1.1	1.1	53.44	140	110	7170	8840	
	90	23	3.5	1.5	53.44	140	110	7170	8840	
	90	23	3.2	2	53.44	140	106	7170	8840	
	90	23	3.5	1.5	52	140	95.5	7170	8840	

Designations	Other dimensions		Contact surface and chamfer dimensions						Weight	
	d1	D1	damin	dbmin	Damax	Dbmax	ramax	rbmax		
mm										
kg										
NUP2205NV/C91YAD	34	41	31		48			0.5	0.6	0.193
NU2205V/C9YA6		40		29	48			1.0	1.0	0.176
NUP2205NV/HAC9YA	34	41	31		47			1.0	0.3	0.193
NUP2205NV/HAC9Y	34	42.8	31		47			1.0	0.5	0.173
NJ305X2V/C3YA46	38		33	33	56			1.0	3.0	0.321
NJ2305V/C3YA46	38	49.5	35	31	56			1.0	3.0	0.378
NUP2305V	39	47	34		56			1.0	1.0	0.401
NCL2206X2V/YA6	41.5		38				57	1.0	2.0	0.272
NU306EV/C9YA6		56.5		37	65			2.0	2.0	0.399
NU306X2V/C3		55.5		35	66			1.0	1.0	0.431
NCL3306X2V	44.25		36				67	1.0	1.5	0.647
NU306X3V		63.5		39	74			1.1	2.5	0.565
NJ307NV/C9	52.2	64.3	48	42	73			1.5	1.5	0.548
NUP307NV/C9	52.2	64.3	47		73			1.5	0.5	0.579
NJ307EV/C3	51	64.3	46	40	73			1.5	1.5	0.540
NJ307EV/YA4	51	64.3	46	40	73			1.5	3.0	0.540
NJ307EV/C9YAD	50.8	64	46	40	73			1.0	1.5	0.537
NJ607V	51	64	46	40	73			1.5	3.5	0.568
NFP2207X1V	50	59	41		75		78	1.0	1.0	0.681
NUP2207X1V/C9YB2	55.5	69	51		82			2.0	5.0	0.795
NJ2207X1V/C9YB2	55.5	69	51	45	82			2.0	5.0	0.780
NUP407X3V/C9YA6	55	71	51		80			2.5	1.0	0.75
NCF407X3V/C9YA6	53	71	49		82		82	5.0	1.5	0.763
NUP307X3EV/C3	54.6	71	42		82			1.5	1.5	0.790
NUP2207X1V/C9YB2-SG	55.5	69	49		82			2.0	1.5	0.795
NUP307X3EV/C3YAB	54.6	71	39		82			1.5	2.0	0.790
NJ607NV	56.5	70	42	43	82			1.5	1.5	0.998
NJ607NV/YB2	56.5	70	42		82			1.5	0.5	0.998
NJ3208X2V/C9	54.5	65.5	51		72			1.5	3.5	0.724
NUP308NV	59.2	75	44		83			1.0	1.0	0.499
NJ308V	59.2	75	53	48	82			3.5	1.5	0.719
NJ308V/C9YA6	59.2	75	50	48	82			3.2	2.0	0.719
NJ308V/C3YA5	57.5	73.4	53	47	82			3.5	1.5	0.724

Full Complement Single-row Cylindrical Roller Bearing

d 85–530 mm

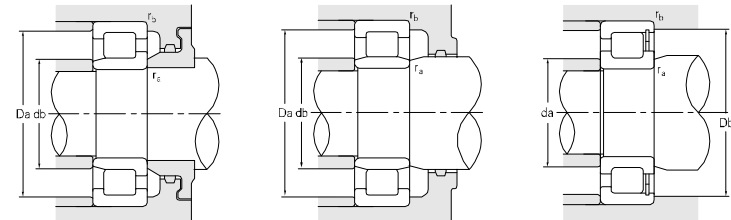
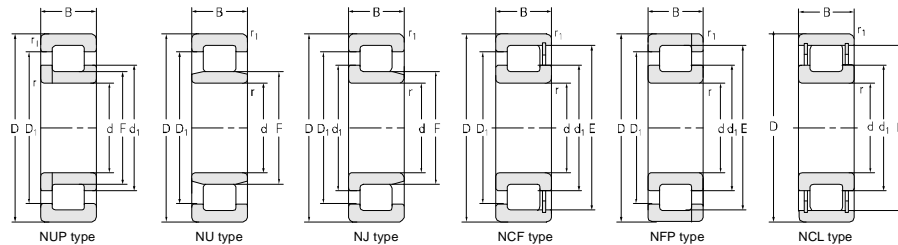

Principal dimensions				Basic load ratings		Limit speed ratings				
d	D	B	r _{1min}	r _{min}	F, E	C _r	C _{or}	Grease	Oil	
						kN	r/min			
mm										
85	180	41	3	3	108	320	380	3160	3900	
114.3	152.4	51.05	2	1.5	127.05	198	545	3140	3870	
120	215	58	2.1	2.1	192.8	515	730	2420	2980	
140	250	68	3	3	169	645	1020	2000	2470	
150	210	36	2	2	163.5	303	540	2220	2740	
220	300	48	2.1	1.5	282.4	550	985	1400	1720	
240	320	28	2.1	2.1	303.3	335	570	1270	1560	
300	420	72	3	3	390.5	1090	2155	870	1070	
	420	72	3	3	390.5	1240	2160	870	1070	
	460	118	4	4	421	1910	3700	840	1040	
320	500	74	4	4	462	1420	2380	760	940	
340	460	72	3	3	367	1170	2420	785	970	
	520	133	5	5	482	2300	4300	710	870	
360	520	82	5	5	483	1430	2620	685	845	
380	520	82	4	4	484.5	1480	3130	665	820	
400	540	82	4	4	511	1600	3400	620	765	
440	540	60	2.1	1.5	516	1020	2550	580	720	
	600	60	2.1	2.1	563	1240	2440	560	695	
	750	46	2.1	2.1	538.5	820	1630	445	550	
530	650	56	3	3	624.5	990	2240	450	555	
	710	72	5	5	672	1800	3550	420	515	

Designations	Other dimensions		Contact surface and chamfer dimensions						Weight
	d1	D1	damin	dbmin	Damax	Dbmax	ramax	rbmax	
mm									
kg									
NUP317EV-RSZ	117	152	98		167		3.0	3.0	5.06
NCL6/114.3V/W33X				122		145	2.0	1.5	2.81
NCF2224V	150	184	131		204	204	2.0	2.0	8.97
NJ2228EV/YA4	181.2	212.8	152	160	236		3.0	3.0	14.1
NCF2930V	171	188	140		200	202	2.0	2.0	3.89
NCF2944V	248	274	232		288	288	2.0	1.5	9.63
NCF2948X2V	269	293	248		308	309	2.0	2.0	6.05
NCF2960V/C3	342	375	314		406	406	3.0	3.0	31.0
NCF2960V/HC	342	375	314		406	406	3.0	3.0	31.0
NCF3060V	355	405	316		443	445	4.0	4.0	71.1
NCF1064X1V	389	439	336		484	485	4.0	4.0	52.4
NCF2968V/C3	383	415	354		445	446	3.0	3.0	34.3
NCF3068V/HC	402	462	360		500	500	5.0	5.0	98.6
NCF1072X1V	414	465	380		500	500	5.0	5.0	55.1
NCF2976V	430.3	466.5	396		504	505	4.0	4.0	52.9
NCF2980V	450	496	416		522	524	4.0	4.0	52.8
NCF2888V	476	504	456		528	530	2.0	1.5	28.9
NCF2988X2V	502	545	455		588	588	2.0	2.0	50.6
NCF1888X1V	486	525	458		558	559	2.0	2.0	29.8
FL-NCF18/530V/CNL	573	612	543		635	636	3.0	3.0	33.9
NCF29/530X2V	592	652	550		690	690	5.0	5.0	77.8

Full Complement Single-row Cylindrical Roller Bearing

d 560~950 mm

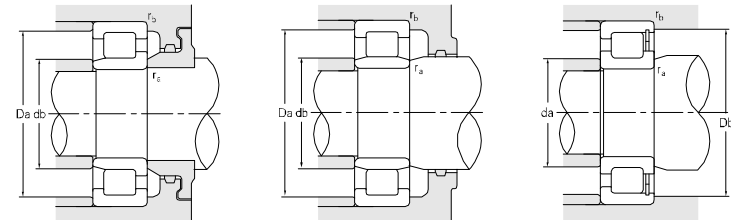
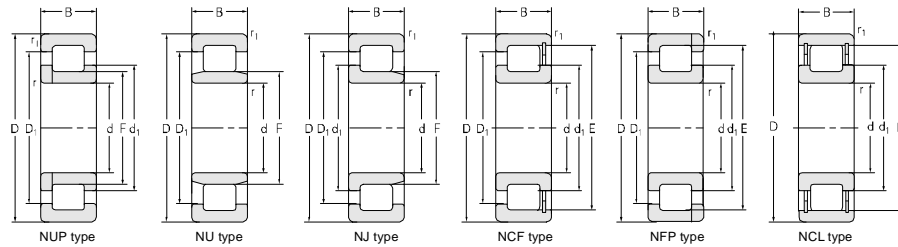

Principal dimensions			Basic load ratings			Limit speed ratings			
d	D	B	r _{1min}	r _{min}	F, E	C _r	C _{or}	Grease	Oil
mm						kN	r/min		
560	750	89	5	5	709	2200	4480	350	430
600	730	60	3	3	696	1050	2530	310	380
	730	60	3	3	696	1080	2620	310	380
	800	90	5	5	753	2310	4700	350	430
750	920	100	5	5	878	2720	6590	255	310
800	980	106	5	5	935.5	2860	7600	220	275
850	1030	106	5	5	985	2910	8100	200	245
900	1180	165	6	6	1120	5950	14500	170	220
950	1150	118	5	5	1101	3500	9600	170	220

Designations	Other dimensions		Contact surface and chamfer dimensions					Weight	
	d1	D1	damin	dbmin	Damax	Dbmax	ramax		rbmax
	mm		mm					kg	
NCF19/560X2V	622	689	582		728	729	5.0	5.0	104
FL-NCF18/600V/CNL NCF18/600V/H CER NCF19/600V	644	687	614		716	716	3.0	3.0	49.4
	644	684	614		716	716	3.0	3.0	49.7
	668	726	624		778	778	5.0	5.0	122
FL-NCF28/750V	812	862	774		898	898	5.0	5.0	140
NCF28/800V	862	919	824		958	958	5.0	5.0	169
NCF28/850V	910	968	874		1006	1008	5.0	5.0	175
NCF29/900V	996	1093	934		1146	1148	6.0	6.0	469
NCF28/950V	1013	1083	974		1143	1144	5.0	5.0	238

Double-row Cylindrical Roller Bearing

d 50-90 mm

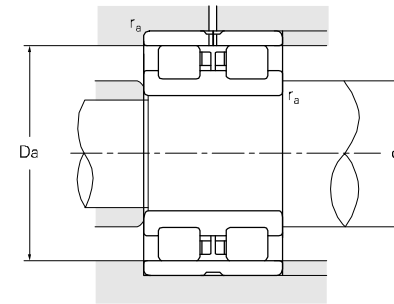
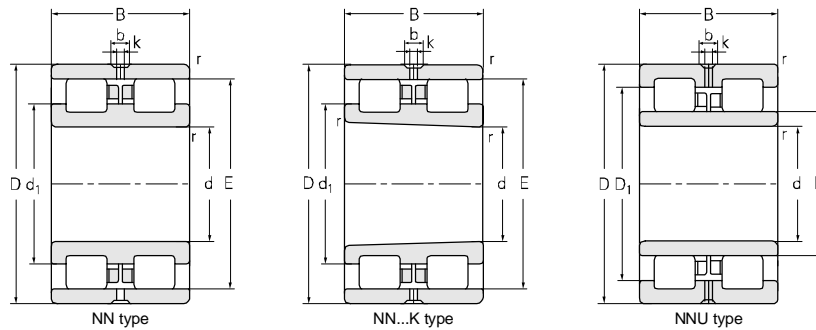

Principal dimensions					Basic load ratings		Limit speed ratings	
d	D	B	r	E.F	C _r	C _{or}	Grease	Oil
mm					kN		r/min	
50	80	23	1	72.5	60.0	85	10000	13000
	80	23	1	72.5	60.0	84.5	10000	13000
	80	23	1	72.5	60.0	84.5	10000	13000
60	95	26	1.1	86.1	77.0	114	9000	10000
70	110	30	1.1	100	98.5	151	8000	9000
	110	30	1.1	100	98.5	151	8000	9000
	110	30	1.1	100	98.5	151	8000	9000
	110	30	1.1	100	98.5	151	8000	9000
	110	30	1.1	100	104	161	8000	9000
75	115	30	1.1	105	106	165	6700	8000
	115	30	1.1	105	106	165	6700	8000
	115	30	1.1	105	106	168	6700	8000
80	125	34	1.1	113	130	207	4500	5600
	125	34	1.1	113	130	207	4500	5600
	125	34	1.1	113	130	207	6300	7500
	125	34	1.1	113	130	207	6300	7500
	125	34	1.1	113	128	207	6300	7500
	125	34	1.1	113	130	207	6300	7500
	125	34	1.1	113	130	207	6300	7500
	125	34	1.1	113	130	207	6300	7500
	125	34	1.1	113	130	207	6300	7500
	125	34	1.1	113	130	207	6300	7500
85	130	34	1.1	118	135	224	4300	5300
	130	34	1.1	118	135	224	4300	5300
	130	34	1.1	118	135	224	4300	5300
90	140	37	1.5	127	147	260	4000	5000
	140	37	1.5	127	147	260	5600	6700
	140	37	1.5	127	147	260	5600	6700
	140	37	1.5	127	147	260	5600	6700
	140	37	1.5	127	147	260	5600	6700
	140	37	1.5	127	147	260	5600	6700

Designations	Other dimensions				Contact surface and chamfer dimensions			Weight
	d1	D1	b	k	d _{amin}	D _{amax}	r _{amax}	
	mm				mm			kg
NN3010K/YA8	61.3				55	75	1	0.428
NN3010/YA8	61.3				55	75	1	0.431
NN3010K/YA8W33	61.3		4.5	3	55	75	1	0.415
NN3012K	73.3				66	89	1	0.691
NN3014KTN1/P492	85.6				80	103	1	1.04
NN3014K/W33	85.6		6.5	3	80	103	1	1.06
NN3014KTN1/P491	85.6				80	103	1	1.04
NN3014K	85.6				80	103	1	1.06
NN3014	85.6				80	103	1	1.06
NN3015K/YA8	90.6				81.5	108.5	1	1.14
NN3015KTN1	90.6				81.5	108.5	1	1.07
NN3015K/W33	90.6		6.5	4	81.5	108.5	1	1.13
NN3016K/C9	97				87	118	1	1.50
NN3016K	97				87	118	1	1.50
NN3016K/YA8	97				87	118	1	1.50
NN3016K/W33YA8	97		6	2.5	87	118	1	1.50
NN3016K/C9W33	97		6	2.5	87	118	1	1.50
NN3016KTN1/P592W33	97		6	2.5	87	118	1	1.49
NN3016KTN1/P492W33	97		6	2.5	87	118	1	1.48
NN3016KTN1/P491	97				87	118	1	1.49
NN3016KTN1/P492	97				87	118	1	1.49
NN3017K/YA8	102				91.5	123.5	1	1.63
NN3017K/C9	102				91.5	123.5	1	1.64
NN3017K/W33	102		6.5	3	91.5	123.5	1	1.62
NN3018/YA8	109.4				98	132	1.5	1.98
NN3018K/YA8	109.4				98	132	1.5	1.95
NN3018K/C9	109.4				106.5	133.5	1	1.95
NN3018K/YA8W33	109.4		6.5	4	98	132	1.5	1.92
NN3018KTN1/P593W33	109.4		6.5	4	98	132	1.5	1.41
NN3018KTN1/P493W33	109.4		6.5	4	98	132	1.5	1.82

Double-row Cylindrical Roller Bearing

d 90-110 mm

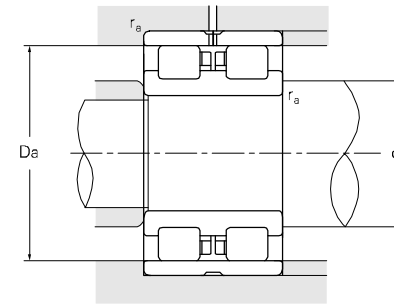
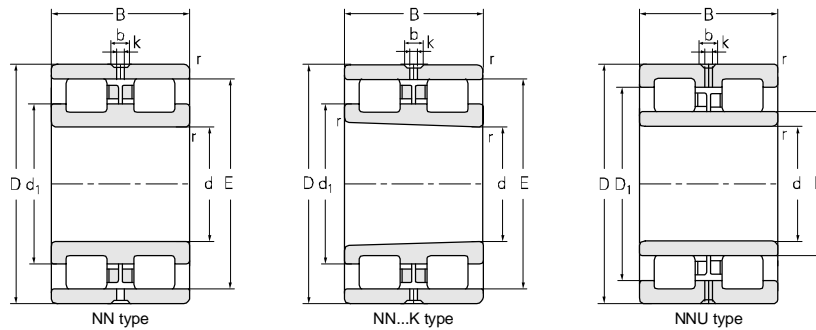

Principal dimensions				Basic load ratings		Limit speed ratings		
d	D	B	r	E,F	C _r	C _{or}	Grease	Oil
mm					kN	r/min		
90	140	37	1.5	127	154	251	5600	6700
	140	37	1.5	127	154	251	5600	6700
	140	37	1.5	127	147	260	5600	6700
	140	37	1.5	127	147	260	5600	6700
95	145	37	1.5	132	135	224	3800	4300
	145	37	1.5	132	150	246	3800	4300
	145	37	1.5	132	150	246	3800	4300
100	140	40	1.1	113	133	267	5200	6200
	140	40	1.1	113	133	267	5200	6200
	150	37	1.5	137	168	292	5300	6300
	150	37	1.5	137	168	292	5300	6300
	150	37	1.5	137	168	292	3600	4500
	150	37	1.5	137	168	292	3600	4500
	150	37	1.5	137	168	292	3600	4500
	150	37	1.5	137	168	292	3600	4500
	150	37	1.5	137	168	292	3600	4500
	150	37	1.5	137	168	292	3600	4500
	150	37	1.5	137	168	292	5300	6300
	150	37	1.5	137	168	292	5300	6300
	150	37	1.5	137	168	270	5300	6300
	150	50	1.5	115	168	292	3600	4500
105	145	40	1.1	118	141	292	4000	4800
	160	41	2.0	146	192	350	4000	4800
	160	41	2.0	146	192	350	4000	4800
	160	41	2.0	146	192	350	4000	4800
	160	41	2.0	146	211	350	4000	4800
110	150	40	1.1	123	137	284	5000	6000
	170	45	2.0	155	220	405	5000	6000
	170	45	2.0	155	220	405	3200	4000
	170	45	2.0	155	220	405	3200	4000
	170	45	2.0	155	220	405	3200	4000

Designations	Other dimensions				Contact surface and chamfer dimensions			Weight
	d1	D1	b	k	d _{amin}	D _{amax}	r _{amax}	
	mm				mm			kg
NN3018KTN1/P491W33	109.4		6.5	4	98	132	1.5	1.82
NN3018KTN1/P493	109.4				98	132	1.5	1.82
NN3018K/C91W33	109.4		6.5	4	98	132	1.5	1.92
NN3018K/SPC91W33	109.4		6.5	4	98	132	1.5	1.92
NN3019K	114.4				103	137	1.5	2.26
NN3019KTN1/P491	114.4				103	137	1.5	2.17
NN3019K/P4W33	114.4		6.5	3	103	137	1.5	2.24
NNU4920/W33		126	5.5	3	108	132	1.5	1.95
NNU4920K/W33		126	5.5	3	108	132	1.5	
NN3020K/YA8	119.4				108	142	1.5	2.20
NN3020KTN1	119.4				108	142	1.5	2.09
NN3020	119.4				108	142	1.5	2.25
NN3020K/W33	119.4				108	142	1.5	2.17
NN3020K/C9YA8	119.4		6	2.5	108	142	1.5	2.18
NN3020K/YA8W33	119.4		6	2.5	108	142	1.5	2.17
NN3020K/C91W33	119.4		6	2.5	108	142	1.5	2.17
NN3020K/C91	119.4				108	142	1.5	2.20
NN3020K/C1LW33	119.4		6	2.5	108	142	1.5	2.17
NN3020K/C9W33	120		6	4	108	142	1.5	2.17
NN3020K/UPC1W33	120		6	4	108	142	1.5	2.17
NN3020KTN1/P493YA8W33	119.4		6	4	108	142	1.5	2.05
NNU4020/YA8		133			108	142	1.5	3.11
NNU4921/P49		130.8			112	138	1	2.01
NN3021	125.2				116.5	154	1	2.94
NN3021K	125.2				116.5	154	1	2.93
NN3021K/C9	125.2				116.6	154	1	2.93
NN3021K/W33	125.2		12	4	116.6	154	1	2.93
NNU4922K/C91W33YA8		135.2	8	3	116.5	143		2.11
NN3022K	132.6				116.5	163	1	3.73
NN3022/YA8	132.6				116.5	163	1	3.74
NN3022KL/P49W33	132.6		12	4	116.5	163	1	3.54
NN3022K/P49W33	132.6		12	4	116.5	163	1	3.71

Double-row Cylindrical Roller Bearing

d 110~140 mm

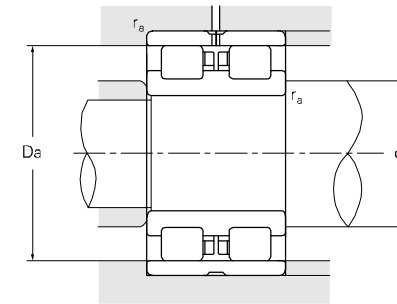
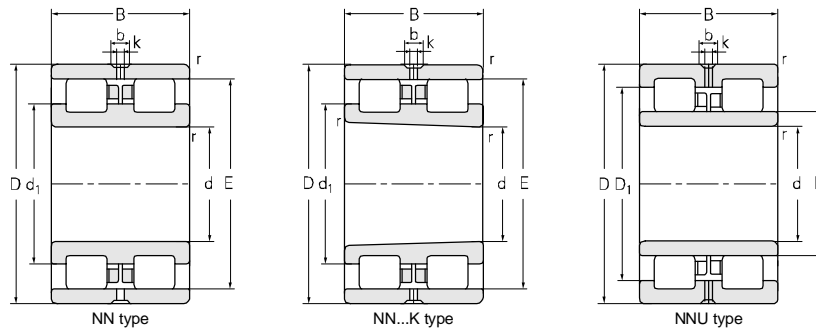

Principal dimensions					Basic load ratings		Limit speed ratings	
d	D	B	r	E,F	C _r	C _{or}	Grease	Oil
mm					kN		r/min	
110	170	45	2.0	155	220	405	3200	4000
	170	45	2.0	155	220	405	3200	4000
	170	45	2.0	155	220	405	3200	4000
	170	45	2.0	155	220	405	3200	4000
	225	150	3.5	138	950	1460	3200	4000
117.61	288.925	134	2.1	208	1240	2390	2800	3400
120	180	46	2.0	165	243	445	4300	5000
	180	46	2.0	165	243	445	4300	5000
	180	46	2.0	165	243	445	3000	3800
	180	46	2.0	165	243	445	3000	3800
	180	46	2.0	165	243	445	3000	3800
	180	46	2.0	160	243	445	3000	3800
	180	46	2.0	165	253	438	3000	3800
	180	46	2.0	165	253	438	3000	3800
130	180	50	1.5	146	250	520	2900	3700
	200	52	2.0	182	305	530	2800	3600
	200	52	2.0	182	305	530	2800	3600
	200	52	2.0	182	305	530	2800	3600
	200	52	2.0	182	305	530	2800	3600
	200	52	2.0	182	305	530	2800	3600
	200	52	2.0	182	305	530	2800	3600
	200	52	2.0	182	305	530	2800	3600
	200	52	2.0	182	305	530	2800	3600
	200	52	2.0	182	305	530	2800	3600
	200	52	2.0	193.9	305	530	2800	3600
	200	52	2.0	182	305	530	2800	3600
	200	52	2.0	182	305	530	2800	3600
	200	52	2.0	182	305	530	2800	3600
	200	52	2.0	182	305	530	2800	3600
	300	172.644	3.0	159.5	1360	2870	1900	2400
139.7	203.2	146.558	2.0	155.5	830	1900	1900	2400
140	190	50	1.5	156	199	405	2800	3400

Designations	Other dimensions				Contact surface and chamfer dimensions			Weight
	d1	D1	b	k	d _{amin}	D _{amax}	r _{amax}	
	mm				mm			kg
NN3022K/SPC91W33	132.6		12	4	116.5	163	1	3.71
NN3022	132.6				116.5	163	1	3.74
NN3022KTN1/P491	132.6				116.5	163	1	3.54
NN3022KTN1/P49	132.6				116.5	163	1	3.54
NNU622Q1/HCYA7		186			120	215	3.5	28.0
NNU6/177X4M/W33X		252.8	11.1	6	188	277	2	35.1
NN3024K	142.6				130	171	2	3.85
NN3024K/W33	142.6		7.5	4	130	171	2	3.65
NN3024K/C9	142.6				130	171	2	3.85
NN3024K/C1LW33	142.6		7.5	4	130	171	2	3.65
NN3024K/C91W33	142.6		7.5	4	130	171	2	3.65
NN3024	142.6				130	171	2	3.86
NN3024KTN1/P492W33YA5	143		7.5	4	130	171	2	3.89
NN3024KTN1/P491W33YA5	143		7.5	4	130	171	2	3.89
NNU4926/W33YAD		163.5	5.5	3	139	171	2	3.95
NN3026	156.4				139	191	2	5.54
NN3026K/C9W33	156.4		9.6	3	139	191	2	5.34
NN3026K/C91	156.4				139	191	2	5.34
NN3026K	156.4				139	191	2	5.34
NN3026K/C93	152.6				139	191	2	5.34
NN3026K/P494	152.6				139	191	2	5.34
NN3026K/W33	152.6				139	191	2	5.35
NN3026K/C92W33	152.6		9.6	5	139	191	2	5.35
NN3026/W33	156.4		9.6	3	139	191	2	5.53
NN3026KTN1/P492	156.4				139	191	2	5.32
NN3026KTN1/P49W33	156.4		9.6	3	139	191	2	5.32
NN3026K/P492	156.4				139	191	2	5.34
NN3026K/P492W33	156.4		9.6	3	139	191	2	5.35
NNFP3326X3	175			9	139	291	2	74.7
NNU6/139.7Q1/C9W33YA2		182	8	4	150	200	2	16.4
NNJ4928		172			149	182	2	4.19

Double-row Cylindrical Roller Bearing

d 140~170 mm

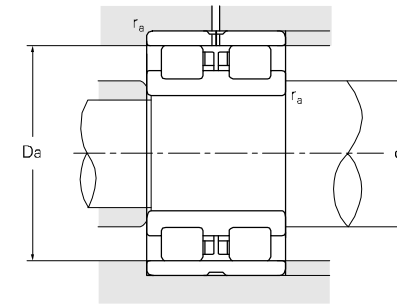
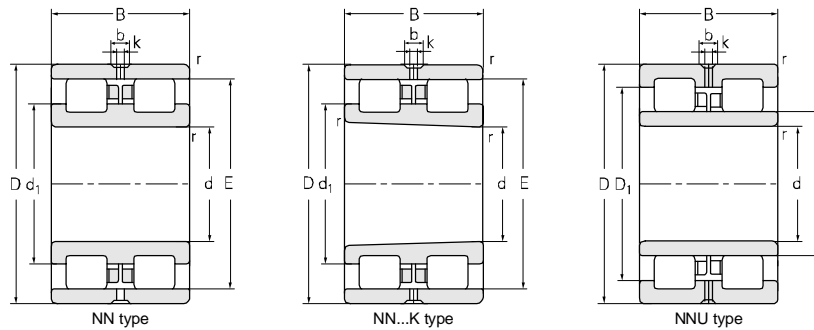

Principal dimensions				Basic load ratings		Limit speed ratings		
d	D	B	r	E,F	C _r	C _{or}	Grease	Oil
mm					kN	r/min		
140	210	53	2.0	160	320	575	2600	3400
	210	53	2.0	192	320	575	3800	4500
	210	53	2.0	192	320	575	2600	3400
	210	53	2.0	192	320	575	2600	3400
	210	53	2.0	192	320	575	2600	3400
	210	53	2.0	192	320	575	2600	3400
	210	53	2.0	192	320	575	2600	3400
	210	53	2.0	192	320	575	2600	3400
150	225	56	2.1	206	363	650	3400	4000
	225	56	2.1	206	363	650	3400	4000
	225	56	2.1	206	363	650	2400	3200
	225	56	2.1	206	363	650	2400	3200
	225	56	2.1	206	363	650	2400	3200
	225	56	2.1	206	363	650	2400	3200
	225	56	2.1	206	363	650	2400	3200
	225	56	2.1	206	363	650	2400	3200
158.75	231.775	161.925	2.1	176.5	1020	2390	2200	3000
160	220	60	2	178.5	345	790	3200	3800
	240	60	2.1	219	375	675	3200	3800
	240	60	2.1	219	380	675	3200	3800
	240	60	2.1	219	380	675	3200	3800
	240	60	2.1	219	380	335	3200	3800
	240	60	2.1	219	380	675	2200	3000
	240	60	2.1	219	380	675	2200	3000
	240	60	2.1	219	380	675	2200	3000
	240	60	2.1	219	380	675	2200	3000
	240	60	2.1	219	380	675	2200	3000
	240	60	2.1	219	380	675	2200	3000
	240	60	2.1	219	380	675	2200	3000
	265	120	3.0	190	1060	1990	1800	2200
170	260	67	2.1	236	470	860	2200	3000
	260	67	2.1	236	470	860	2200	3000
	260	67	2.1	236	470	860	2200	3000
	260	67	2.1	236	470	860	2200	3000
	260	67	2.1	236	470	860	2200	3000
	306	278	2.76	276	1650	2690	1700	2200

Designations	Other dimensions				Contact surface and chamfer dimensions			Weight
	d1	D1	b	k	d _{amin}	D _{amax}	r _{amax}	
	mm				mm			kg
NNU3028/C9W33		185.6	9.6	5	149	201	2	6.18
NN3028K	166.4				149	201	2	6.05
NN3028K/C9	166.4				149	201	2	6.05
NN3028KTN1	166.4				149	201	2	5.76
NN3028	166.4				149	201	2	6.05
NN3028K/C91W33	166.4		9.6	5	149	201	2	6.00
NN3028K/W33	166.4		9.6	5	149	201	2	6.00
NN3028K/SPC1W33	166.4		9.6	5	149	201	2	6.00
NN3030K	178.8				161	214	2	7.70
NN3030/YA8	178.8				161	214	2	7.75
NN3030	178.8				161	214	2	7.75
NN3030/C9	178.8				161	214	2	7.75
NN3030/C9YA8	178.8				161	214	2	7.75
NN3030K/C91W33	178.8		8.5	4.5	161	214	2	7.70
NN3030K/W33	178.8		8.5	4.5	161	214	2	7.70
NNU6/158X4Q1/W33X		205.5	8.3	4	170	220	2	23.9
NNU4932K/C9W33		197.7	6.5	3	171	210	1	6.73
NN3032K/C91W33	190.2		8.5	4.5	171	229	2	8.38
NN3032K	190.2				171	229	2	8.39
NN3032K/P494	190.2				171	229	2	8.39
NN3032KTN1	190.2				171	229	2	7.86
NN3032K/W33	190.2		8.5	4.5	171	229	2	8.38
NN3032K/SPC1W33	190.2		8.5	4.5	171	229	2	8.38
NN3032K/YB2	190.2				171	229	2	8.39
NN3032K/C9W33YB2	190.2		8.5	4.5	171	229	2	8.38
NN3032	190.2				171	229	2	8.38
NNU4132X3/HCYA7W33X		242	6.5	3.2	171	232	2	29
NN3034K	204				181	249	2	12.9
NN3034/YA8	204				181	249	2	13.3
NN3034K/C9	204				181	249	2	12.9
NN3034K/W33	204		9.6	5	181	249	2	12.9
1-2029	215				181	287		67.2

Double-row Cylindrical Roller Bearing

d 177.8-220 mm

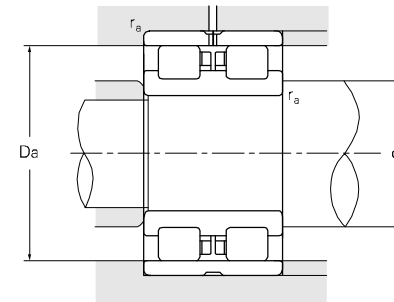
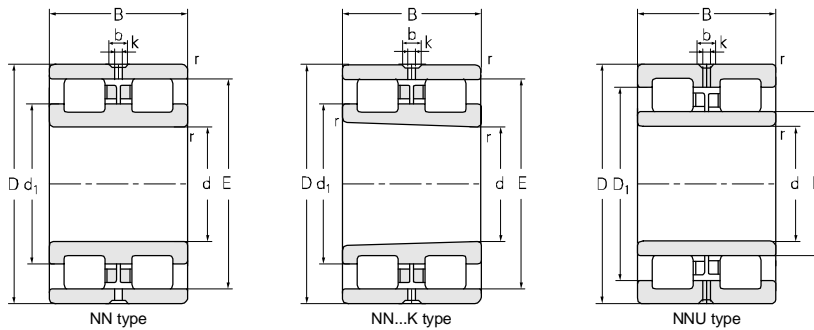

Principal dimensions					Basic load ratings		Limit speed ratings	
d	D	B	r	E,F	C _r	C _{or}	Grease	Oil
mm					kN		r/min	
177.8	257.175	196.85	2	197.5	1250	3050	1800	2500
180	250	69	2	201	382	703	2000	2800
	260	88	2.0	198	578	1045	2000	2600
	280	74	2.1	255	605	1090	2800	3400
	280	74	2.1	255	605	1090	2800	3400
	280	74	2.1	255	605	1090	2000	2800
	280	219	3.5	205	1580	3490	2000	2800
190	260	69	3.0	212	616	1250	1900	2600
	260	69	2.0	212	462	905	1900	2600
	260	69	2	212	500	1100	1900	2600
	260	69	2	212	420	905	1900	2600
	260	69	2	212	420	905	1900	2600
	290	75	2.1	265	622	1140	2600	3200
	290	75	2.1	265	622	1140	1900	2600
	290	75	2.1	265	622	1140	1900	2600
	290	180	2.1	219	1390	3200	1900	2600
200	280	80	2.1	225	484	1040	2500	3200
	310	82	2.1	282	675	1340	2400	3000
	310	82	2.1	282	675	1340	1900	2400
	310	82	2.1	282	675	1340	1900	2400
	310	82	2.1	282	740	1340	1900	2400
	310	109	2.1	227	1030	1920	1900	2400
206.375	285.75	222.25	4.0	226	1460	4500	1800	2200
	285.75	222.25	5.0	226	1460	4500	1800	2200
220	300	80	2.1	245	530	1200	1800	2200
	300	80	2.1	245	530	1200	1800	2200
	300	80	2.1	245	530	1200	1800	2200
	300	80	2.1	279	530	1200	1700	2000
	300	95	2.1	245	535	1200	1800	2200
	310	110	2.1	288.3	820	1790	1800	2200
	340	90	3.0	310	875	1610	1800	2200

Designations	Other dimensions				Contact surface and chamfer dimensions			Weight
	d1	D1	b	k	d _{amin}	D _{amax}	r _{amax}	
	mm				mm			kg
NNU6/177X4Q1/C9-1-NJB		230.5	15.88	9.5	188	247	2	33.9
NNU4936K		228			191	239	2	9.80
NND5936X3/C4YB4		234.8			191	250	2	14.8
NN3036K	218.2				191	269	2	16.9
NN3036K/W33	218.2		12.2	6	191	269	2	16.9
NN3036	218.2				191	269	2	16.9
NNU6036X2/C91-LS		247.5	15	8	191	269	3.5	51.4
NNU4938B-W33		257	9.5	5	201	249	2	11
NNU4938/C4YA4		236			201	249	2	11.0
NNU4938/W33A		237.6	9.5	6	201	249	2	11.0
NNU4938K/W33		236	9.5	5	201	249	2	10.4
NNU4938K/P491		236			201	249	2	10.4
NN3038K	228.2				201	279	2	17.9
NN3038K/W33	228.2		15	6	201	279	2	17.1
NN3038	228.2				201	279	2	18.0
NNU6038		236			201	279	2	43.6
NNU4940K/W33		253	12.2	6	211	269	2	14.8
NN3040K	242				211	299	2	22.0
NN3040	242				211	299	2	22.1
NN3040K/C9	242				211	299	2	22
NN3040K/W33	242		12.2	5	211	299	2	21.8
NNU4040/C9W33X		272	11.1	6	211	299	2	29.9
NNU6/206X4M/C9		259	12.7	8	218	273	3.0	43.9
NNU6/206X4Q1/C9-NJB		259	15.88	9.5	218	273	4.0	43.9
NNU4944/P53W33		273	12.2	6	231	289	2	16.6
NNU4944K/SPC1W33		273	12.2	6	231	289	2	16.6
NNU4944K		273			231	289	2	16.0
NN4944K/W33	251		12.2	6	231	289	2	16.0
NNU4944WB/W33		273	12.2	6	231	289	2	17.7
NN3044X3/C9W33T	254.7		12	6	231	309	2	25.7
NN3044K	265.2				233	327	2.5	30.1

Double-row Cylindrical Roller Bearing

d 220~280 mm

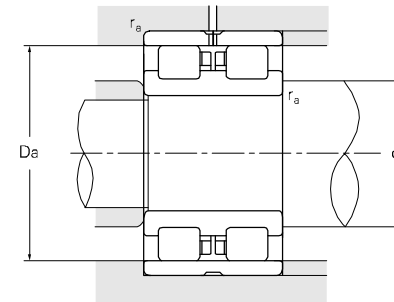
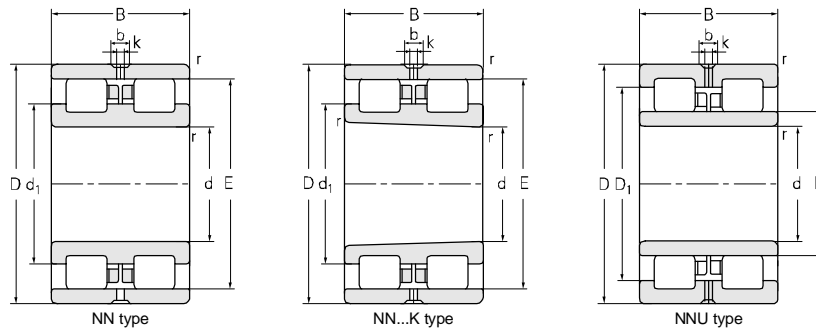

Principal dimensions					Basic load ratings		Limit speed ratings	
d	D	B	r	E,F	C _r	C _{or}	Grease	Oil
mm					kN	r/min		
220	340	90	3.0	310	875	1610	1800	2200
	340	90	3.0	310	875	1610	1800	2200
	340	90	3.0	310	875	1610	1800	2200
	370	150	4.0	258	1660	3030	1800	2200
240	320	80	2.1	265	625	1470	1700	2000
	320	80	2.1	265	625	1470	1700	2000
	320	80	2.1	265	625	1470	1700	2000
	320	80	2.1	265	625	1470	1700	2000
	320	80	2.1	265	630	1470	1700	2000
	320	80	2.1	301	630	1470	1700	2000
	360	92	3.0	330	885	1690	2000	2600
	360	92	3.0	330	885	1690	1700	2000
	360	92	3.0	330	885	1690	1700	2000
	360	92	3.0	330	885	1690	1700	2000
260	360	80	2.1	292	666	1500	1600	1900
	360	100	2.1	292	760	2030	1400	1700
	360	100	2.1	292	760	2030	1400	1700
	360	100	2.1	292	790	1850	1400	1700
	360	100	2.1	292	835	2030	1400	1700
	360	100	2.1	292	835	2030	1400	1700
	360	100	2.1	292	760	2030	1400	1700
	400	104	2.1	364	1010	2120	1900	2600
	400	104	2.1	364	1010	2120	1900	2600
	400	104	2.1	364	1010	2120	1900	2600
	400	104	4	364	1140	2200	1900	2600
	400	104	4.0	364	1110	2120	1900	2600
	400	104	4.0	364	1110	2120	1900	2600
	400	110	4.0	364	1110	2120	1900	2600
	400	140	4	295	1570	3000	1150	1500
	440	180	4.0	306	2240	4500	1000	1300
280	380	100	2.1	309	870	2200	1300	1600
	380	100	2.1	309	870	2200	1300	1600

Designations	Other dimensions				Contact surface and chamfer dimensions			Weight kg
	d1	D1	b	k	d _{amin}	D _{amax}	r _{amax}	
	mm				mm			
NN3044K/W33	265.2		15	6	233	327	2.5	30.0
NN3044	265.2				233	327	2.5	31.0
NN3044/C1W33	265.2		15	6	233	327	2.5	30.9
NNU4144/W33	321		13.9	6	236	354	3.0	64.3
NNU4948/P63W33		295	12.2	6	251	309	2	17.8
NNU4948/P53W33		295	12.2	6	251	309	2	17.8
NNU4948/C3W33		295	12.2	6	251	309	2	17.8
NNU4948K/SPC1W33		295	12.2	6	251	309	2	17.7
NN4948K/W33	271.4		12.2	6	251	309	2	17.2
NN4948/W33	271.4		12.2	6	251	309	2	18.0
NN3048K	285.2				253	347	2.5	32.7
NN3048	285.2				253	347	2.5	31.6
NN3048K/P51W33	285.2		15	6	253	347	2.5	32.6
NN3048K/SPC1W33	285.2		15	6	253	347	2.5	32.6
NNU4952X2/C9W33		325	9.5	5	273	347	2.5	28.2
NNU4952/W33YA4		325	15	6	273	347	2.6	31.7
NNU4952/W33		325	15	6	273	347	2.7	31.7
NNU4952K/P4-HS		324			273	347	2	30.8
NNU4952K/P4		325			273	347	2	30.4
NNU4952K/SPC1W33		325	15	6	273	347	2	30.4
NNU4952K/W33	326		15	6	273	347	2	30.4
NN3052/SPW33	312.8		15	6	276	384	2	49.2
NN3052K/SPW33	312.8		15	6	276	384	2	49.6
NN3052K/P49W33YB5	312.8		15	6	276	384	2	49.2
NN3052	312.8				276	384	2	49.8
NN3052K/P51W33	312.8		15	6	276	384	3	49.2
NN3052K	312.8				276	384	3	49.3
NN3052WCK/W33XYA8	312.8		18	10	276	384	3	49.6
NNU4052/W33		358	13.9	7.5	276	384	3	63.4
NNU4152		387			276	424	3	111
NNU4956K/P52W33		347	15	6	291	369	2	27.5
NNU4956	326	347			291	369	2	29

Double-row Cylindrical Roller Bearing

d 280~360 mm

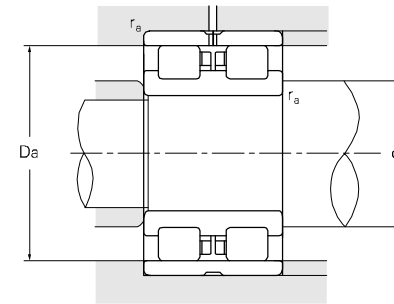
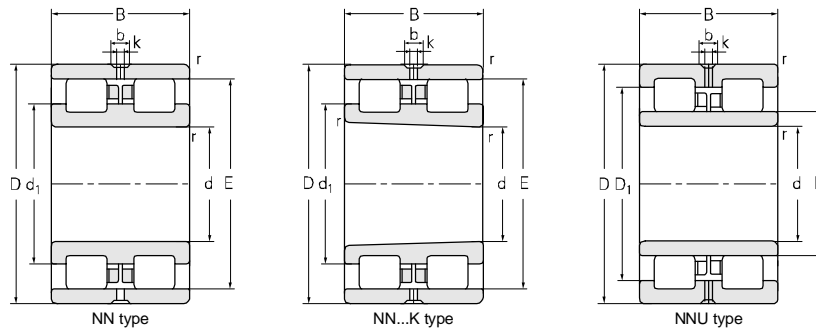

Principal dimensions					Basic load ratings		Limit speed ratings	
d	D	B	r	E,F	C _r	C _{or}	Grease	Oil
mm					kN		r/min	
280	380	100	2.1	312	810	1980	1300	1600
	420	106	4.0	384	1170	2290	1800	2200
	420	106	4.0	384	1170	2290	1400	1700
	420	106	4.0	384	1170	2290	1400	1700
	420	106	4.0	384	1170	2290	1400	1700
460	180	5.0	326	2500	4700	900	1200	
285	415	102	3.0	317	1350	2780	900	1200
300	420	118	3.0	339	1050	2800	1200	1500
	420	118	3.0	339	1050	2800	1200	1500
	420	118	3	387	1150	2800	1200	1500
	420	118	3.0	339	1150	2800	1200	1500
	460	118	3	418	1420	2790	1200	1500
	460	118	3	339	1150	2800	1200	1500
	460	118	4.0	418	1290	2790	1200	1500
	460	118	4.0	418	1290	2790	1200	1500
460	118	4.0	418	1560	2790	1200	1500	
320	440	118	3.0	359	1090	3040	1100	1400
	460	120	4.0	363.65	1460	3510	1100	1400
	480	121	4.0	438	1360	2910	1100	1400
	480	121	4.0	438	1360	2910	1100	1400
	480	121	4.0	438	1500	2910	1100	1400
	480	121	4.0	438	1500	2910	1100	1400
	480	145	3.7	364	1820	3870	1100	1300
	480	160	4.0	360	2130	4400	1100	1300
	540	176	5.0	384	2500	4900	900	1100
	340	520	133	5	473	1730	3780	900
520		133	5	473	1900	3780	900	1050
520		133	5	473	1900	3780	900	1050
520		180	5	385	2490	4800	860	1000
580		243	5	402	4000	7550	780	940
360		540	134	5.0	493	1940	3900	900

Designations	Other dimensions				Contact surface and chamfer dimensions			Weight
	d1	D1	b	k	d _{amin}	D _{amax}	r _{amax}	
	mm				mm			kg
NUU4956K/P4-HS		344			291	369	2	32.8
NN3056K	332.8				296	404	3	49.7
NN3056	332.8				296	404	3	52.3
NN3056K/P52W33	332.8		15	6	296	404	3	49.6
NN3056K/SPW33	332.8		15	6	296	404	3	49.7
NUU4156		407			300	440	4	118
NNP657/HCRYAD		368			300	406	2.5	48.4
NUU4960/C3W33		379	17.7	9	314	406	2.5	51.6
NUU4960/C9		379			314	406	2.5	52.2
NN4960/W33	347		17.7	9	314	406	2.5	52
NUU4960K/W33		379	17.7	9	314	406	2.5	49.3
NN3060K	360.4		17.7	9	316	444	3	75.9
NUU4960K/SPC1W33					316	444	3	49.3
NN3060K/YA8	360.4				316	444	3	76.2
NN3060/YA8	360.4		17.7	9	316	444	3	77.9
NN3060K/P51W33YA8	360.4	379			316	444	3	75.8
NUU4964/W33		399	17.7	9	334	426	2.5	54.9
NU3064X3ZW/HAP55S2YA3					336	444	3	71.4
NN3064/W33	377		17.7	8	336	464	3	76.3
NN3064K/P52W33	377		17.7	8	336	464	3	72.8
NN3064K/P4W33	377		17.7	8	336	464	3	75.3
NN3064K/SPW33	377		17.7	8	336	464	3	75.3
NUU4064X2/C9W33		424	18	8	336	464	3	93.3
NUU4064M/W33		426	16.7	9	336	464	4	102
NUU3164/HCW33		463	16.7	8	340	520	5	169
NN3068K/W33	406		16.7	9	360	500	4	99.5
NN3068K/SPW33	406		16.7	9	360	500	4	99.5
NN3068K/P4W33			16.7	9	360	500	4	99.5
NUU4068/W33X	406	460	12	6	360	500	4	136
NUU4168		510			360	560	4	267
NN3072K/P52W33	426		17.7	12	380	497	4	105

Double-row Cylindrical Roller Bearing

d 380~460 mm

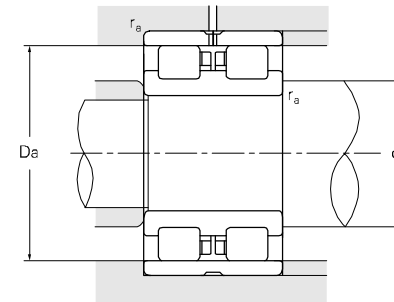
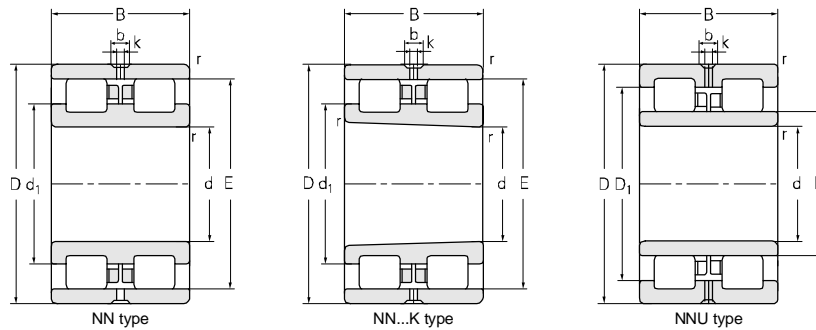

Principal dimensions				Basic load ratings		Limit speed ratings		
d	D	B	r	E,F	C _r	C _{or}	Grease	Oil
mm				kN		r/min		
380	520	140	4.0	426	1640	4280	1300	1500
	520	140	4.0	426	1640	4280	1300	1500
	560	135	5.0	431	1860	3800	1300	1500
	560	135	5.0	515	1800	4100	1300	1500
	620	243	5.0	442	4130	8350	700	850
	620	243	5.0	442	4140	8350	700	850
	620	243	5.0	442	4100	8350	700	850
400	540	140	4	446	1700	4500	950	1000
	540	140	4	502	1700	4500	950	1000
	600	148	5	549	2360	4750	1150	1300
	600	170	5.0	450	2900	6000	800	950
	650	250	6.0	463	4700	9550	1000	1250
	650	250	6.0	463	4700	9550	1000	1250
	650	250	6.0	463	4700	9550	1000	1250
420	560	140	4.0	466	1650	4750	850	1000
	560	140	4.0	466	1810	4750	850	1000
	560	140	4.0	466	1810	4750	850	1000
	580	130	4.0	468	1790	4660	860	1100
	580	130	4.0	468	1790	4660	860	1100
	620	150	5	569	2100	4500	1000	1250
	620	150	5	469	2750	5570	1000	1250
	620	200	5	469	3450	7500	750	900
	620	220	5	469	3250	7810	750	900
	440	640	230	6.0	482	4790	10400	700
650		212	6	487	3850	8250	700	850
650		212	6	487	3850	8250	700	850
720		280	6	511	5650	11500	600	700
720		280	6	511	5650	11500	600	700
460	680	163	6.0	624	2600	6200	1000	1200
	680	163	6	624	2600	6200	1000	1200

Designations	Other dimensions				Contact surface and chamfer dimensions			Weight
	d1	D1	b	k	d _{amin}	D _{amax}	r _{amax}	
	mm				mm			kg
NUU4976K/SPC1W33	471	16.7	9	396	504	4	86.7	
NUU4976K/W33	471	16.7	9	396	504	4	86.7	
NUU3076	498			400	517	4	113.6	
NN3076K/P52W33	448	17.7	12	400	517	4	110	
NUU4176/C9	538			400	580	4	288	
NUU4176	538			400	580	4	288	
NUU4176/C9W33	538	16.7	9	400	580	4	287	
NUU4980K/W33	491	16.7	8	416	524	3	90.6	
NN4980K/SPW33	457	16.7	8	416	524	3	90.4	
NN3080K	472			426	580	4	141	
NUU3080X2/HC	532	22	10	426	580	4	172	
NUU4180	568			426	624	5	328	
NUU4180/W33	568	22.3	12	426	624	5	326	
NUU4180/HG2W33	568	22.3	12	426	624	5	326	
NUU4984K/P52W33	515	17.7	9	436	539	4	93.3	
NUU4984/SPW33	515	17.7	9	436	539	4	94.3	
NUU4984K/SPW33	515	17.7	9	436	600	4	93.3	
NU684ZWF1/YA3	522			563	465	4	110	
NU684ZWF1/C9YA3	522			563	465	4	110	
NN3084K/W33	497	16.7	9	574	539	4	135	
NUU3084	556			574	600	4	152	
NUU4084/W33	556	16.7	9	440	600	4	204	
NUU4084X3/HCEW33X	536	12	6	440	600	4	205	
NNP4088X3/W33	602	16.7	7.5	466	614	5	256	
NUU4088/W33	582	22.3	12	466	624	5	214	
NUU4088K/W33	582	22.3	12	466	624	5	214	
NUU4188K30M/W33	638	22.3	12	466	694	5	452	
NUU4188/W33	638	22.3	12	466	694	5	452	
NN3092K/P52W33	544	20.5	12	486	627	5	198	
NN3092/SPYB5W33	544	20.5	12	486	627	5	199	

Double-row Cylindrical Roller Bearing

d 460~500 mm

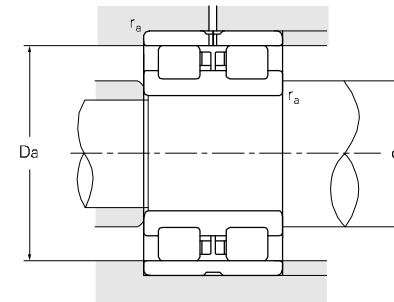
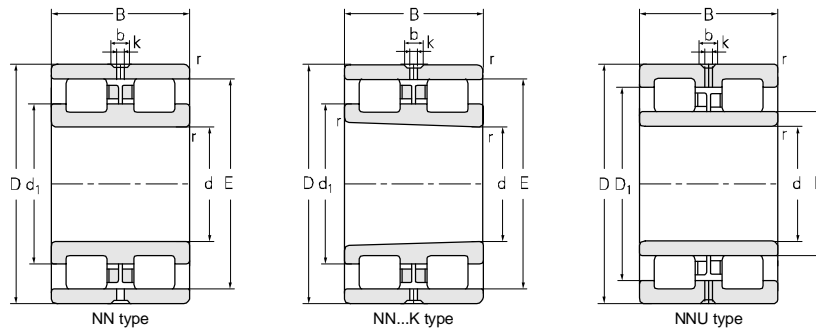

Principal dimensions					Basic load ratings		Limit speed ratings	
d	D	B	r	E,F	C _r	C _{or}	Grease	Oil
mm					kN		r/min	
460	580	118	3	497	1150	3250	840	950
	580	118	3	497	1150	3250	840	950
	620	160	4	510	2000	5400	800	900
	620	160	4	510	2000	5400	800	900
	680	163	6	624	2500	5500	950	1150
	680	218	6	513	4250	9300	650	780
	680	218	6	513	4250	9300	650	780
	680	218	6	513	3930	8860	650	780
	760	300	7.5	537	6350	13000	550	650
	760	300	7.5	537	6350	13000	550	650
480	650	170	5	534	2300	6150	720	880
	650	170	5	534	2300	6150	720	880
	650	170	5	534	2270	6100	720	880
	700	165	6	644	2500	5800	930	1000
	700	165	6	644	2500	5800	930	1000
	700	218	6	533	4200	9600	620	720
	790	308	7.5	557	7000	14400	500	600
	790	308	7.5	557	7000	14400	500	600
	790	308	7.5	557	6550	13400	500	600
	500	670	160	5.0	554	2450	6800	750
670		170	5	554	2330	6100	750	1000
670		170	5	554	2330	6100	750	1000
720		167	6	664	2650	5800	950	1100
720		167	6	664	2650	5800	950	1100
720		218	6	553	4450	10500	620	740
720		218	6	553	4450	10500	620	740
720		218	6.0	554	4900	9300	580	700
720		270	6.0	559	5586	14300	580	700
730		305	6.0	676	6200	15100	600	700
830		325	7.5	582	7400	14500	580	700
830		325	7.5	583	8400	14500	580	700

Designations	Other dimensions				Contact surface and chamfer dimensions			Weight
	d1	D1	b	k	d _{amin}	D _{amax}	r _{amax}	
	mm				mm			kg
NNU4892K/W33		537	16.7	9	474	566	2.5	75
NNU4892/W33		537	16.7	9	474	566	2.5	75
NNU4992/W33		565	16.7	9	476	604	3	132
NNU4992K/W33		565	16.7	9	476	604	3	128
NN3092K/W33	544		22.3	12	627	654	5	185
NNU4092/W33		614	22.3	12	486	654	5	238
NNU4092K/W33		614	22.3	12	486	654	5	235
NNU4092/HCW33		602	22.3	12	486	654	5	281
NNU4192K30		672			493	727	6	533
NNU4192		672			493	727	6	535
NNU4996/W33		592	22.3	12	500	630	4	150
NNU4996K/W33		592	22.3	12	500	630	4	148
NNU4996K/SPC1W33		588	22.3	12	500	630	4	161
NN3096/W33	564		22.3	12	648	674	5	198
NN3096K/W33	564		22.3	12	648	674	5	192
NNU4096/W33		634	22.3	12	506	674	5	272
NNU4196/W33		701	22.3	12	513	757	6	591
NNU4196K/W33		701	22.3	12	513	757	6	585
NNU4196/HCW33YB2		691	27.5	12	513	757	6	613
NNU49/500X2F1/YA34		612			520	650	4	174
NNU49/500F1/W33X		612	22.3	12	520	650	4	178
NNU49/500K/W33X		612	22.3	12	520	650	4	178
NN30/500K/SPC1W33	584		22.3	12	668	694	5	221
NN30/500K/P51W33	584		22.3	12	668	694	5	221
NNU40/500/W33		654	22.3	12	526	694	5	285
NNU40/500K/W33		654	22.3	12	526	694	5	282
NNU40/500/HCW33		647	22.3	12	520	697	5	288
NNU50/500X2/HCP59W33T		648	32.3	20	520	697	5	383
NNP6/500/HCP63W33YB5	556		22.3	12	526	704	5	435
NNU41/500/W33		734	22.3	12	533	797	6	705
NNU41/500/HCEW33		725	23.7	12	533	797	5	696

Double-row Cylindrical Roller Bearing

d 530~630 mm

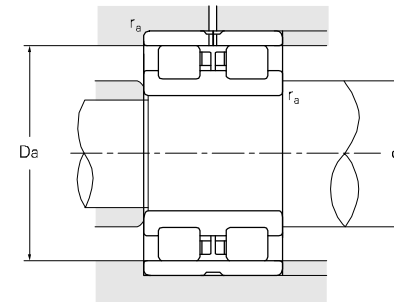
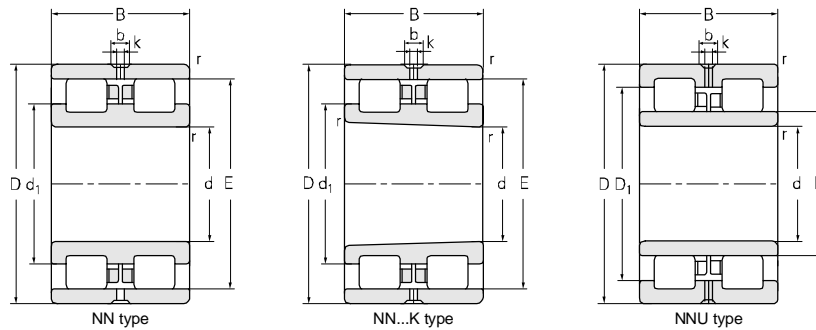

Principal dimensions					Basic load ratings		Limit speed ratings	
d	D	B	r	E.F	C _r	C _{or}	Grease	Oil
mm					kN		r/min	
530	710	180	5.0	588	2930	7450	700	950
	760	260	5.0	587	5800	14100	880	950
	780	185	6.0	715	3110	6800	880	950
	780	185	6.0	715	3110	6800	880	950
	780	335	7.5	612	8800	16500	880	950
	780	185	6	715	3250	7250	880	980
	780	185	6	715	3250	7250	880	980
	780	250	6	591	5400	12100	550	650
	780	250	6	591	5400	12100	550	650
	870	335	7.5	618	7750	15500	460	550
870	335	7.5	618	7750	15500	460	550	
560	750	190	5.0	623	3210	8950	630	750
	750	190	5.0	693	2690	7900	630	750
	750	190	5.0	703	3190	8800	630	750
	750	190	5.0	623	3210	8950	630	750
	750	190	5.0	623	3210	8950	630	750
	750	190	5.0	693	2690	7900	630	750
	820	195	6.0	755	3720	8170	600	850
	820	195	6.0	755	3720	8150	600	850
	820	258	6.0	756	5900	14000	600	850
	820	258	6.0	756	5900	14000	530	630
	820	258	6.0	626	5900	14000	530	630
	600	800	200	5.0	666	3700	11400	560
860		300	6.0	802	7000	17000	580	700
870		200	6.0	805	4460	9850	600	800
870		200	6.0	805	4650	10500	600	800
870		200	6.0	805	4460	9850	600	800
980		375	7.5	699	9800	21000	380	450
980		375	7.5	699	9800	21000	380	450
630		780	150	4.0	738	2270	6900	500
	920	212	7.5	850	4350	10600	550	750
	920	212	7.5	850	4350	10600	550	750

Designations	Other dimensions				Contact surface and chamfer dimensions			Weight kg
	d1	D1	b	k	d _{amin}	D _{amax}	r _{amax}	
	mm				mm			
NNU49/530/HCW33		649	17.7	6	550	690	4	203
NNP40/530X3/HCW33		684	22.3	12	550	751	4	394
NN30/530K/P51W33	625				720	754	5	302
NN30/530/P5W33	626		22.3	12	720	754	5	311
NNU41/530/HCW33		760	23.8	12	558	752		783
NN30/530/W33	625		22.3	12	720	754	5	262
NN30/530K/W33	625		22.3	12	720	754	5	258
NNU40/530/W33		706	22.3	12	556	754	5	415
NNU40/530K/W33		706	22.3	12	556	754	5	410
NNU41/530K30/W33		770	22.3	12	563	837	6	788
NNU41/530/W33		770	22.3	12	563	837	6	788
NNU49/560/W33		689	22.3	12	580	730	4	245
NN49/560K/P41W33	632		23.5	12	580	730	4	233
NN49/560/P49W33YB5	637		22.3	12	580	730	4	240
NNU49/560K/W33		689	22.3	12	580	730	4	235
NNU49/560K/W33X		689	22.3	12	580	730	4	235
NN49/560K/P51W33	632		23.5	12	580	730	4	233
NN30/560K	658.4				590	790	6	337
NN30/560K/P5W33	658.4		22.3	12	590	790	6	336
NN40/560/HCW33	650		22.3	12	590	790	6	465
NN40/560/W33	650		22.3	12	590	790	6	465
NNU40/560/P63W33YB5		732	22.3	12	590	790	6	468
NNU49/600/P63W33YB5		737	22.3	12	620	780	4	282
NN40/600X3K/P49W33YB5	690		22.3	12	624	836	5	535
NN30/600KF1/YA8	701				630	840	6	384
NN30/600F3/YA8	701		15	8	630	840	6	403
NN30/600F1/YA8	701		15	8	630	840	6	403
NNU41/600/HCW33		864	22.3	12	634	946	6	1123
NNU41/600/HCCNH33YA3		864	22.3	12	634	946	6	1123
NN48/630K/P51W33	686		20.5	8	650	760	4	161
NN30/630KF1/YA8	738				660	890	6	438
NN30/630F1/YA8	738		15	8	660	890	6	460

Double-row Cylindrical Roller Bearing

d 670~900 mm

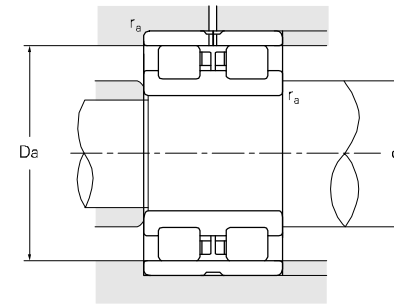
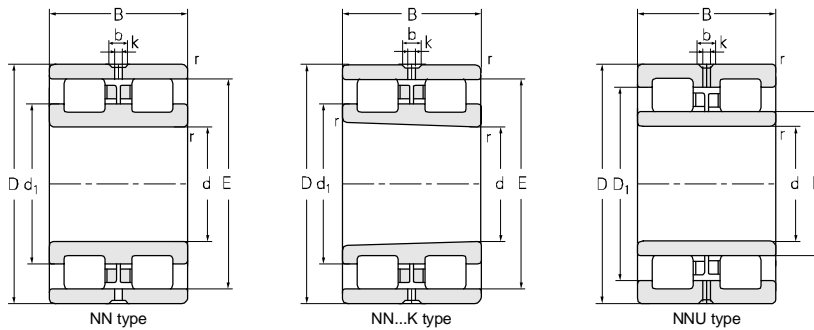

Principal dimensions				Basic load ratings		Limit speed ratings		
d	D	B	r	E,F	C _r	C _{or}	Grease	Oil
					kN	r/min		
mm								
670	900	230	6.0	738	4900	12500	500	600
	900	230	6.0	738	4750	13300	500	600
	980	230	7.5	760	4980	11300	670	750
	980	230	7.5	900	4980	11300	670	750
690	980	365	7.5	759	9950	26100	560	670
710	870	180	4	823	2600	8500	480	550
	950	243	6.0	770	5730	15200	450	530
	950	243	6.0	782	5730	16500	450	530
	950	243	6.0	782	5250	15000	450	530
	1030	236	7.5	951	5500	12500	580	650
	1030	315	7.5	784	9000	21500	380	450
750	1150	438	9.5	820	12800	28000	310	370
	920	170	5	879	3550	10000	460	530
	1000	250	6	831	5400	15800	420	480
	1090	250	7.5	1013	6800	15000	550	600
	1090	250	7.5	1007	7050	16000	550	620
	1090	335	7.5	830	10000	23500	350	420
800	1220	475	9.5	871	16000	35600	280	350
	1060	258	6	884	5800	16500	360	440
	1150	258	7.5	1065	7500	17500	510	580
	1150	258	7.5	1065	7500	17500	510	580
	1150	345	7.5	885	10500	26500	330	380
850	1280	475	9.5	921	15500	36000	270	325
	1120	272	6	939	5650	17500	350	420
	1220	272	7.5	1130	7800	18000	470	520
	1220	272	7.5	1130	7800	18000	470	520
	1220	365	7.5	940	11000	28000	290	350
	1360	500	12	976	19000	44500	230	285
900	1180	280	6	986	6300	19000	330	380
	1280	280	7.5	1185	7920	19000	310	370

Designations	Other dimensions				Contact surface and chamfer dimensions			Weight		
	d1	D1	b	k	d _{amin}	D _{amax}	r _{amax}			
mm										
kg										
NNU49/670/C3 NNU49/670/W33T-JG NNU30/670 NN30/670K/P49W33	788	822	22.3	12	696	870	5	424		
		822			18	10	696	870	5	424
		872			704	907	6	594		
		872			704	907	6	593		
NNU6/690/HCEC9W33YB2	881	30	15	724	940	6	912			
NN48/710X2K NNP49/710/C9YA57 NNP49/710/C9YA7 NNU49/710K/SPC1W33 NN30/710/W33 NNU40/710/W33 NNU41/710/W33	771.8	831	22.3	12	736	850	4	223		
					890	736	896	5	493	
					878	736	896	5	512	
					868	736	896	5	469	
					868	744	957	6	595	
					937	744	996	6	858	
					1024	750	1110	8	1800	
					1024	750	1110	8	1800	
NN48/750K30/W33 NNU49/750 NN30/750/W33 NN30/750/P63W33YB5 NNU40/750/W33 NNU41/750/W33	877	918	22.3	12	770	887	4	235		
					776	974	5	535		
					784	1011	6	700		
					784	1011	6	767		
					991	1000	6	924		
1083	790	8	2240							
NNU49/800/W33X NN30/800K/W33 NN30/800/W33 NNU40/800/W33 NNU41/800/W33	929	974	22.3	12	826	1034	5	614		
					833	1071	6	750		
					833	1071	6	785		
					833	1117	6	1150		
					840	1240	8	2380		
					840	1240	8	2380		
NNU49/850/W33X NN30/850/W33 NN30/850K/W33 NNU40/850/W33 NNU41/850/W33	986	1029	22.3	12	876	1094	5	715		
					883	1187	6	935		
					883	1187	6	930		
					883	1187	6	1350		
					897	1334	10	2890		
					897	1334	10	2890		
NNU49/900/W33X NN30/900/W33	1082	1185	22.3	12	926	1154	5	843		
					933	1191	6	1050		

Double-row Cylindrical Roller Bearing

d 900~1250 mm

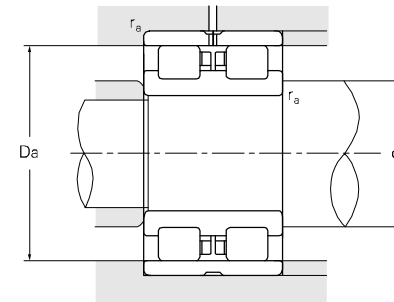
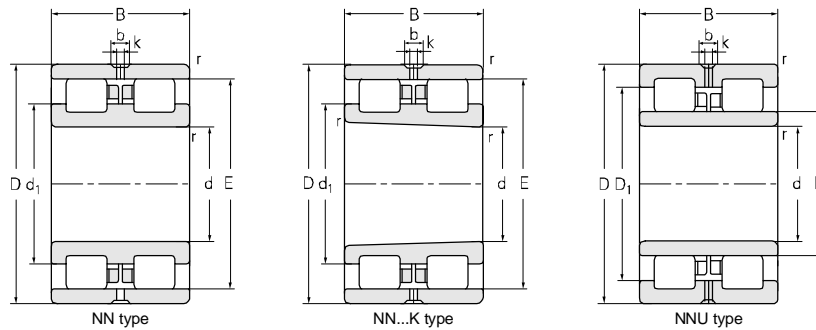

Principal dimensions				Basic load ratings		Limit speed ratings		
d	D	B	r	E.F	C _r	C _{or}	Grease	Oil
					kN		r/min	
mm								
900	1280	375	7.5	990	12500	31000	275	330
	1420	515	12	1032	20500	47000	210	270
	1420	515	12	1032	20500	47000	210	270
950	1250	300	7.5	1046	7050	22300	410	460
	1360	300	7.5	1255	8750	22500	390	440
	1360	300	7.5	1255	8750	22500	390	440
	1360	412	7.5	1050	13500	35000	250	315
	1500	545	12	1092	24500	56500	195	250
1000	1320	315	7.5	1238	8500	26000	380	440
	1320	315	7.5	1103	8500	26000	380	440
	1420	308	7.5	1316	10000	24600	370	420
	1420	412	7.5	1101	15000	38000	230	290
	1580	580	12	1154	27200	62500	190	250
1060	1400	335	7.5	1160	10000	30600	350	380
	1400	335	7.5	1160	10000	30600	350	380
	1500	325	9.5	1391	10500	37500	350	380
	1500	325	9.5	1391	10500	37500	350	380
	1660	600	15	1214	29000	69400	175	210
	1660	600	15	1214	29000	69400	175	210
	1660	600	15	1214	29000	69400	175	210
1120	1460	335	7.5	1220	10000	31500	330	370
	1460	335	7.5	1220	10000	31500	330	370
	1750	630	15	1279	33500	76600	165	190
	1750	630	15	1279	33500	76600	165	190
1180	1540	355	7.5	1285	11500	35500	310	350
	1540	355	7.5	1285	11500	35500	310	350
	1850	670	15	1350	35500	83500	150	185
	1850	670	15	1350	35500	83500	150	185
1250	1950	710	15	1426	41500	98500	120	160
	1950	710	15	1426	41500	98500	120	160

Designations	Other dimensions				Contact surface and chamfer dimensions			Weight
	d1	D1	b	k	d _{amin}	D _{amax}	r _{amax}	
mm								
kg								
NNU40/900/W33	990		22.3	12	933	1257	6	1510
NNU41/900/W33	1032		22.3	12	947	1394	10	3160
NNU41/900K/W33	1032		22.3	12	947	1394	10	3160
NNU49/950/W33X	1103	1149	22.3	12	983	1217	6	958
NN30/950/W33			22.3	12	983	1263	6	1418
NN30/950K/W33	1103		22.3	12	983	1263	6	1374
NNU40/950/W33		1237	22.3	12	983	1327	6	1890
NNU41/950/W33		1338	22.3	12	997	1474	10	3850
NN49/1000	1124		22.3	12	1249	1287	6	1210
NNU49/1000/W33X	1156	1212	22.3	12	1033	1287	6	1250
NN30/1000/W33			22.3	12	1324	1387	6	1385
NNU40/1000/W33		1296	22.3	12	1033	1387	6	1985
NNU41/1000K30/W33		1408	22.3	12	1047	1474	10	4250
NNU49/1060/W33	1223	1288	22.3	12	1093	1367	6	1360
NNU49/1060K/W33			22.3	12	1093	1367	6	1360
NN30/1060/W33	1223		22.3	12	1100	1399	8	1650
NN30/1060K/W33			22.3	12	1100	1399	8	1650
NNU41/1060/W33		1485	22.3	12	1116	1627	12	5075
NNU41/1060K/W33		1485	22.3	12	1116	1627	12	5075
NNU49/1120/W33		1348	22.3	12	1153	1427	6	1440
NNU49/1120K/W33		1348	22.3	12	1153	1427	6	1440
NNU41/1120/W33		1567	22.3	12	1176	1717	12	5570
NNU41/1120K30/W33		1567	22.3	12	1176	1717	12	5570
NNU49/1180/W33		1421	22.3	12	1213	1507	6	1660
NNU49/1180K30/W33		1421	22.3	12	1213	1507	6	1660
NNU41/1180/W33		1655	22.3	12	1227	1817	6	7200
NNU41/1180K/W33		1655	22.3	12	1227	1817	6	7200
NNU41/1250/W33		1748	22.3	12	1297	1917	12	8000
NNU41/1250K30/W33		1748	22.3	12	1297	1917	12	8000

Double-row Cylindrical Roller Bearing

d 1320~1500 mm

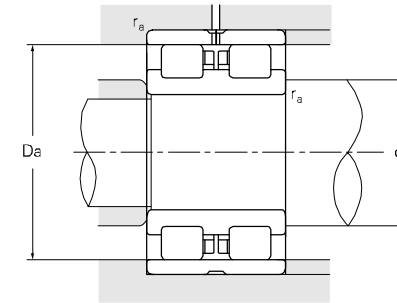
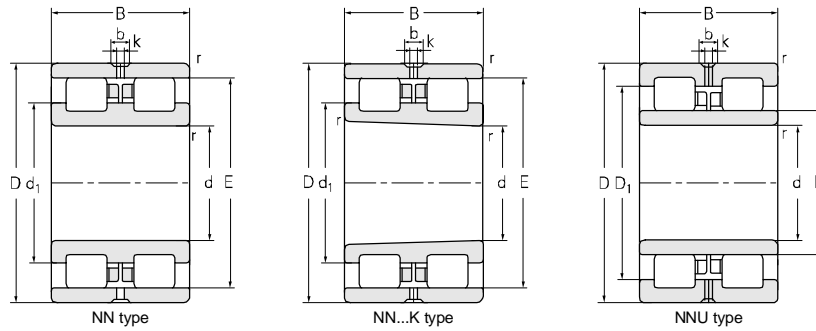

Principal dimensions				Basic load ratings		Limit speed ratings		
d	D	B	r	E.F	C _r	C _{or}	Grease	Oil
mm					kN		r/min	
1320	1720	400	7.5	1620	13200	42500	260	300
	1720	400	7.5	1620	13200	42500	260	300
	1720	400	7.5	1442	13500	42500	260	300
	1720	400	7.5	1442	13500	42500	260	300
	2060	750	15	1507	45600	106000	130	150
1400	2180	775	19	1598	49500	117000	90	120
	2180	775	19	1598	49500	117000	90	120
1500	2300	800	19	1709	52500	132000	85	110

Designations	Other dimensions				Contact surface and chamfer dimensions			Weight
	d1	D1	b	k	d _{amin}	D _{amax}	r _{amax}	
	mm				mm			kg
NN49/1320/W33	1468		22.3	12	1353	1640	6	3040
NN49/1320K/W33	1468		22.3	12	1353	1640	6	3040
NNU49/1320/W33		1592	22.3	12	1353	1687	6	3100
NNU49/1320K/W33		1592	22.3	12	1353	1687	6	3100
NNU41/1320/W33		1846	22.3	12	1367	2027	6	9450
NNU41/1320K/W33		1846	22.3	12	1367	2027	6	9450
NNU41/1400/W33		1954	22.3	12	1470	2140	8	10700
NNU41/1400K30/W33		1954	22.3	12	1470	2140	8	10700
NNU41/1500/W33		2065	22.3	12	1570	2260	8	12300

Full Complement Double-row Cylindrical Roller Bearing

d 40–300 mm

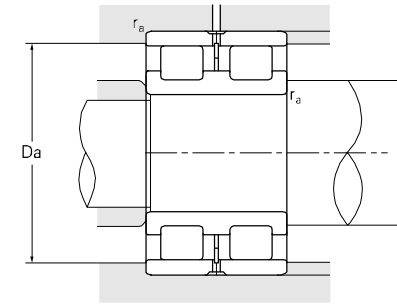
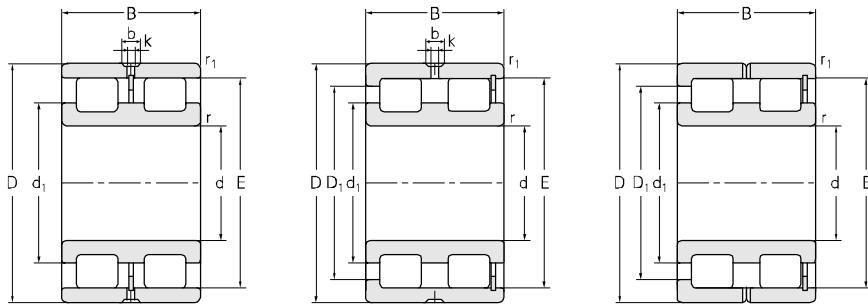

Principal dimensions						Basic load ratings		Limit speed ratings	
d	D	B	r _{1min}	r _{min}	E	C _r	C _{or}	Grease	Oil
mm						kN		r/min	
40	68	38	0.6	0.8*30*	60.8	102	135	5840	7240
	68	38	1.0	0.8*30*	60.8	102	135	5840	7240
	68	38	0.6	0.8*30*	60.8	102	135	5840	7240
80	125	60	1.1	1.1	115.6	295	440	3000	3800
85	130	60	1.1	1.1	121.4	308	455	3000	3700
89	125	58	1.1	1.1	97.22	155	295	2900	3600
90	125	58	1.1	1.1	97.22	155	295	2900	3600
	140	67	1.5	1.5	130	360	550	2700	3350
110	170	80	2.0	2.0	154.5	500	800	2200	2700
	260	110	1.0	1.0	132	1010	1500	1580	1950
120	165	45	1.1	1.1	154.3	245	465	2140	2650
130	200	95	2.0	2.0	185	735	1200	1800	2240
140	210	95	2.0		195.5	780	1320	1700	2100
180	250	69	2.0	2.0	231	570	1200	1300	1600
190	290	136	2.1	2.1	269.6	1420	2500	1130	1400
220	300	80	2.1	2.1	276.8	710	1570	950	1180
240	320	80	2.1	2.1	299.8	765	1800	930	1150
260	400	190	4	4	366.2	2750	5000	740	920
280	420	190	4	4	391.5	2810	5600	690	850
	420	190	4	4	391.5	2810	5600	690	850
300	380	80	2.1	2.1	358.5	850	2200	720	890

Designations	Other dimensions				Contact surface and chamfer dimensions			Weight
	d ₁	D ₁	b	k	d _{amin}	D _{amax}	r _{amax}	
	mm				mm			kg
NNF5008V	50.3				44	63	0.6	0.553
NNCF5008V	50.3	57.3	7	3	44	63	1.0	0.553
NNF5008CV	50.4		4.5	3	44	63	0.6	0.552
NNCF5016V	96.4	110.8	5	3.5	85	120	1.0	2.65
NNCF5017V/W33	99.5	115.2	4	2	91.5	123.5	1.0	2.73
NUCL6/89V/YA3DF		111.6			96.5	118.5	1.0	1.87
NUCL3918X2V/YA3DF		111.6			106.5	114	1.0	1.81
NNCF5018V	106.5	124			106.5	133.5	1.0	3.68
NNCF5022V	130				116.5	164	1.0	6.49
NNFPL2422X3V/HAP59		184			116.5	238	1	34
NNCL4924V/W33	135.5		6	3.5	127	158	1	2.72
NNCF5026V	156.2	177.8	7	4	140	191	2.0	10.8
NNCF5028V	164.5	188.9			147	205	2.0	11.3
NNCF4936V	206	224	8.66	4	190	240	2.0	10.3
NNCF5038V	199	231	9.5	4	200	280	2.0	32.5
NNCF4944V/C3	248	269	9.3	4	231	319	2.0	16.8
NNC4948V/C3	273	292	8	4	251	309	2.0	18.3
FL-NNCF5052V/C3	304.6	351.8	9.4	5	276	384	3.0	85.0
NNCF5056V	323	375	9.4	5	296	403	3.0	89.4
NNCF5056V/YA2	323	375	9.4	5	296	403	3.0	89.4
NNCL4860V	327.5	351.5	12	5	312	369	2.0	21.0

Full Complement Double-row Cylindrical Roller Bearing

d 300~670 mm

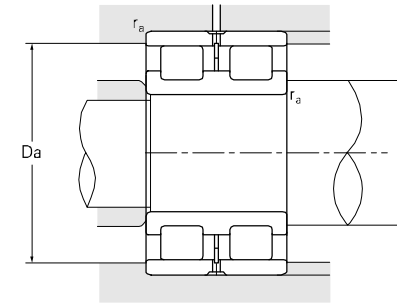
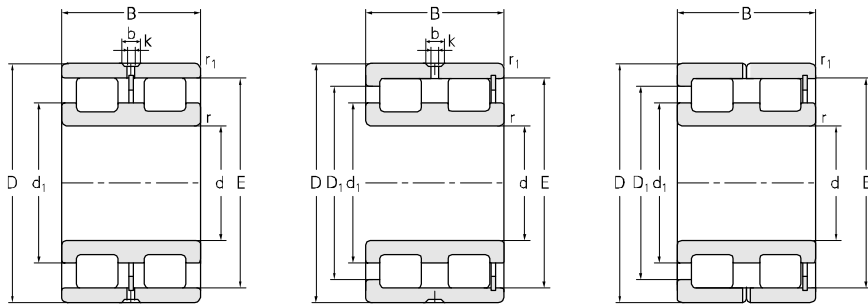

Principal dimensions						Basic load ratings		Limit speed ratings	
d	D	B	r _{1min}	r _{min}	E	C _r	C _{or}	Grease	Oil
mm						kN		r/min	
300	420	118	3.0	3.0	390.2	1445	3300	660	820
380	540	260	4.0	4.0	508	4150	9840	470	580
420	520	100	2.1	2.1	493	1675	4950	455	560
460	580	118	3.0	3.0	544	1740	5480	390	485
480	600	118	3.0	3.0	567	2000	5750	370	460
	650	170	5.0	5.0	605	3100	8000	370	460
500	670	170	5.0	5.0	554	2390	6870	335	415
560	820	258	6.0	6.0	762	6850	15600	260	320
	820	400	6.0	6.0	771	9810	23200	260	320
630	850	218	6.0	6.0	795	5270	14200	230	290
670	1090	412	7.5	7.5	774	13985	30720	175	220

Designations	Other dimensions				Contact surface and chamfer dimensions			Weight
	d ₁	D ₁	b	k	d _{amin}	D _{amax}	r _{amax}	
	mm				mm			kg
NNCF4960V/C3	343	381			314	412	2.5	49.3
NNCL5076X3V/HCC9T	436				396	524	3.0	154
NNCL4884V/C9W33X	456		10	8	428	509	2.0	48.4
NNCS4892V/W33	506		20.5	12	474	560	2.5	75.5
NNCS4896V/W33	529		20.5	12	500	588	2.5	78.4
	538	588			500	630	4.0	163
NNU49/500/W33		607	22.3	12	520	650	4.0	174
NNCL40/560V/W33	652		22.3	12	574	806	5.0	451
	651				590	790	5.0	578
NNCL49/630V/W33	710		22.3	12	646	826	5.0	351
NNU41/670/HCW33		948	23.5	12	700	1060	6.0	1530

Double-row Sealed Full Complement Cylindrical Roller Bearing

d 30-120 mm

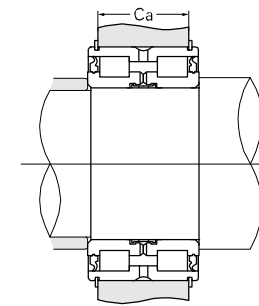
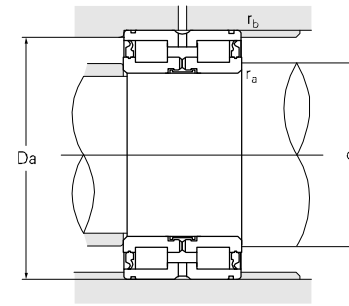
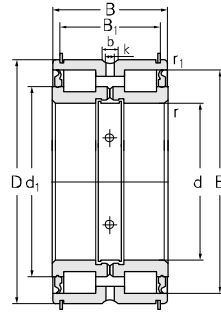
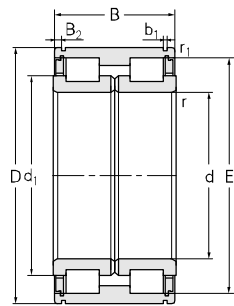

Principal dimensions						Basic load ratings		Limit speed ratings		Designations
d	D	B	r _{1min}	r _{min}	E	C _r	C _{or}	Grease	Oil	
mm						kN		r/min		
30	70	60	1.1	1.1		154	232	6000	7500	NNUP6206X1V-2RS/HCO NNUP6206X1V-2RS
	70	60	1.1	1.1		154	232	6000	7500	
40	68	38	0.6	0.8*30*	60.8	86.0	129	5600	7000	NNF5008-2LSV NNF5008-2LSV/W33 NNF5008-2LS1V/W33 NNF5008-2LS1V NNF4208R-2LS1V
	68	38	0.6	0.8*30*	62	81.0	118	5600	7000	
	68	38	0.6	0.8*30*	62	81.0	118	5600	7000	
	68	38	0.6	0.8*30*	62	81.0	118	5600	7000	
	80	40	0.5	1.5*30*	62	99	154	5600	7000	
55	110	46	0.5	1.5*30*	85.2	150	220	3800	4500	NNF4211X1R-2LS1V
65	100	46	0.6	1.0*30*	90	137	244	3800	4500	NNF5013-2LSNRV
70	110	54	0.6	1.0*30*	100	190	325	3500	4300	NNF5014-2LSNV NNF5014-2LSNRV NNF5014-2LS1NRV/DIN NNF5014-2LS1NV
	110	54	0.6	1.0*30*	100.2	200	350	3500	4300	
	110	54	0.6	1.0*30*	100.2	190	325	3500	4300	
	110	54	0.6	1.0*30*	101.9	190	325	3500	4300	
75	115	54	0.6	1.0*30*	106.2	210	380	3300	4000	NNF5015-2LS1V
80	125	60	0.6	1.5*30*	115.6	251	428	3000	3700	NNF5016-2LSNRV
85	130	60	0.6	1.5*30*	119.5	255	445	2900	3500	NNF5017-2LSNRV
90	140	67	0.6	1.5*30*	127.2	303	568	2600	3200	NNF5018-2LSNRV-XG NNF5018-2LS1NV
	140	67	0.6	1.5*30*	128.6	303	568	2600	3200	
100	150	67	1.0	1.0*30*	138	320	590	2400	3000	NNF5020-2RSV
110	170	80	1.5	1.0*30*	154	380	790	2100	2700	NNF5022-2LSV NNF5022-2LSNRV NNF5022-2LS1V NNF5022-2LS1NRV
	170	80	0.6	1.8*30*	154.6	405	750	2100	2700	
	170	80	1.5	1.0*30*	155.4	380	790	2100	2700	
	170	80	0.6	1.0*30*	155.4	405	750	2100	2700	
120	180	80	0.6	1.8*30*	164	445	885	2000	2500	NNF5024-2LSNV NNF5024-2LSNRV
	180	80	0.6	1.8*30*	164.5	430	830	2000	2500	

Other dimensions			Contact surface and chamfer dimensions				Dimensions related to snap ring				Weight
d1	b	k	d _{amin}	D _{amax}	r _{amax}	r _{bmax}	B1	B2	b1	Ca	
mm			mm				mm				kg
43			50	62	1.0	1.0					1.31
43			50	62	1.0	1.0					1.31
50.3			44	63	0.8	0.5					0.553
50.3	4.5	3	44	63	0.8	0.5					0.583
50.3	4.5	3	44	63	0.8	0.5					0.583
50.3			44	63	0.8	0.5					0.583
50.3			45	73	1.5	0.5					1.16
69			60	102	1.5	0.5					2.54
77.2			73	94	1.0	0.5	40.2	2.4	3.2	35	1.35
85			75	105	1.0	0.5	48.2	2.4	4.2	42	1.85
84.2	7.2	3.5	75	105	1.0	0.5	48.2	2.4	4.2	42	1.90
84.2			75	105	1.0	0.5	48	2.5	4.2	40	1.99
85			75	105	1.0	0.5	48.2	2.4	4.2	42	1.85
91.2			82	110	1.0	0.5					2.06
97.5			88	120	1.5	0.5	54.2	2.4	4.2	49	2.81
102.5	7.2	3	92	125	1.5	0.5	54.2	2.4	4.2	49	2.88
108.6	7.2	3.5	98	134	1.5	0.5	59	3.5	4.2	54	3.76
108.6			98	134	1.5	0.5	59	3.5	2.7	54	3.99
118			106	145	1.0	0.5					3.99
131			117	165	1.0	1.5					6.93
131	7.2	3.5	117	165	1.8	0.5	70.2	4.4	4.2	65	6.63
131			117	165	1.0	1.5					6.93
131			117	165	1.0	0.5	70	4.5	4.2	62	6.63
141			127	175	1.8	0.5	74	4.0	3.2	65	7.41
141	7.2	3.5	127	175	1.8	0.5	71.2	3.9	4.2	65	7.08

Double-row Sealed Full Complement Cylindrical Roller Bearing

d 120~240 mm

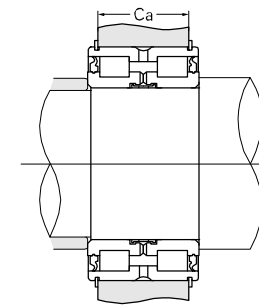
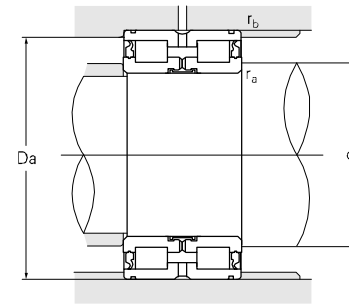
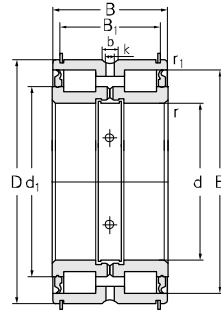
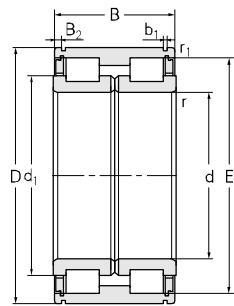

Principal dimensions					Basic load ratings		Limit speed ratings		Designations	
d	D	B	r _{1min}	r _{min}	C _r	C _{or}	Grease	Oil		
mm					kN		r/min			
120	180	80	0.6	1.8*30*	164.5	430	830	2000	2500	NNF5024-2LSNRV/YA1
	180	80	0.6	1.8*30*	165.4	445	885	2000	2500	NNF5024-2LS1NV
	215	80	0.6	1.8*30*	189	515	850	1600	2100	NNF5024X1-2LSV
130	200	94	1.0	1.8*30*	185.2	540	1000	1800	2200	NNF5026-2LSNRV
	200	95	1.0	1.8*30*	185.2	540	1000	1800	2200	NNF5026-LS1NRV
	200	95	1.0	1.8*30*	186.6	540	1000	1800	2200	NNF5026-2LS1NRV
140	190	150	1.5	1.5	176.5	280	550	1800	2200	NNCD4928V-2RS
	200	80	0.6	1.8*30*	183.2	470	960	1700	2100	NNF4028X2-2LSNRV
	210	95	0.6	1.8*30*	191.3	610	1100	1600	2000	NNF5028-2LSNRV
150	210	80	0.6	1.8*30*	193.3	490	1100	1600	2000	NNF5930-2LSNRV
	225	100	0.6	2*30*	207.5	710	1400	1500	1900	NNF5030-2LSNRV
160	240	109	0.6	2*30*	222.6	835	1680	1400	1700	NNF5032-2LSNRV
	240	109	1.1	2*30*	224	835	1680	1400	1700	NNF5032-2LS1NRV/YB2
	240	109	0.6	2*30*	224	835	1680	1400	1700	NNF5032-2LS1NRV/DIN
	240	109	0.6	2*30*	224	835	1680	1400	1700	NNF5032-2LS1NRV
	240	109	1.1	2*30*	222.6	835	1680	1400	1700	NNF5032-2LSNRV/YB2
170	230	80	0.6	1.8*30*	216.2	520	1170	1400	1700	NNF5934-2LSNRV
	260	122	0.6	2*30*	239	1010	1990	1300	1600	NNF5034-2RSV
	260	122	0.6	2*30*	239	1010	1990	1300	1600	NNF5034-2RSNV
	260	122	0.6	2*30*	239	1010	1990	1300	1600	NNF5034-2LSNRV
	260	122	0.6	2*30*	239	1010	1990	1300	1600	NNF5034-2LSNRV-1
180	280	135	0.6	2*30*	254	1140	2380	1200	1400	NNF5036-2LSNRV
	280	135	2.1	2*30*	254	1140	2380	1200	1400	NNF5036-2LSV
	280	136	2.1	2*30*	255.5	600	2380	1200	1400	NNF5036-2LS1V
	280	136	0.6	2*30*	255.5	660	2380	1200	1400	NNF5036-2LS1NRV/DIN
	280	136	0.6	2*30*	255.5	660	2380	1200	1400	NNF5036-2LS1NRV
200	270	80	0.6	1.8*30*	251	590	1380	1100	1400	NNF4940X1-2LSNRV
240	360	160	1.1	2*30*	329.5	1580	3850	1000	1300	NNF5048-2LS1NRV/DIN

Other dimensions			Contact surface and chamfer dimensions				Dimensions related to snap ring				Weight
d1	b	k	d _{amin}	D _{amax}	r _{amax}	r _{bmax}	B1	B2	b1	Ca	
mm			mm				mm				kg
141	7.2	3.5	127	175	1.8	0.5	71.2	3.9	4.2	63	7.08
141			127	175	1.8	0.5	71	4.0	3.2		7.41
156	7.2	3.5	127	208	1.8	0.5					12.5
158			137	195	1.8	1.0	83	5.5	3.2	77	11.1
158			137	195	1.8	1.0	83	5.5	3.2	77	10.8
158			137	195	1.8	1.0	83	5.5	3.2	77	11.1
159.5			150	180	1.5	1.5					4.03
159.6	7.2	3.5	147	194	1.8	0.5	71.2	3.9	4.2	65	8.17
166	7.2	3.5	147	204	1.8	0.5	83.2	5.4	5.2	77	11.7
171.3	7.2	3.5	159	204	1.8	0.5	71.2	3.9	5.2	65	8.6
177.5	9.3	4.5	159	218	2.0	0.5	87.2	5.9	5.2	81	13.7
191			167	235	2.0	0.5	96	6.0	6.0	86	18.8
191			167	232	2.0	1.0	95	6.5	4.0	89	18.4
191			167	235	2.0	0.5	95.2	6.4	5.2	85.2	18.8
191			167	235	2.0	0.5	96	6.0	6.0	86	18.8
191			167	232	2.0	1.0	95	6.5	4.0	89	18.4
192.2	7.2	3.5	178	224	1.8	0.5	71.2	3.9	5.2	65	9.42
177			177	255	2.0	0.5					23.5
203			177	255	2.0	0.5	107.2	6.9	5.2	99	23.5
203	12	6	177	255	2.0	0.5	107.2	6.9	5.2	99	23.5
203			177	255	2.0	0.5	107.2	6.9	5.2	99	24.5
218			191	272	2.0	0.5	118.2	8.4	5.2	110	33.3
218			191	269	2.0	2.0					32.5
218			191	269	2.0	2.0					32.5
218			191	272	2.0	0.5	118.2	8.4	5.2	108.2	33.5
218			191	272	2.0	0.5	118.2	8.4	5.2	110	33.3
225	7.2	3.5	208	264	1.8	0.5	73.2	2.9	5.2	65	13.6
279.5			248	352	2.0	1.0	138.2	10.4	6.3	126	60.7

Double-row Sealed Full Complement Cylindrical Roller Bearing

d 240~280 mm

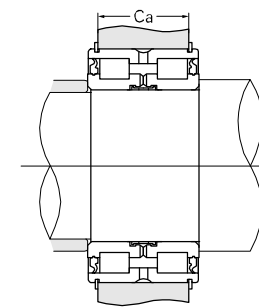
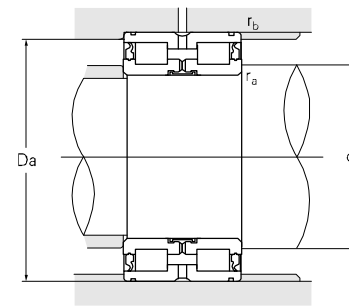
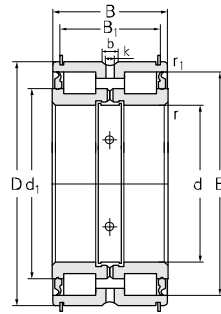
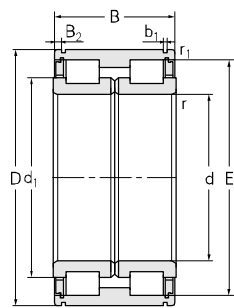

Principal dimensions						Basic load ratings		Limit speed ratings		Designations	
d	D	B	r _{1min}	r _{min}	E	C _r	C _{or}	Grease	Oil		
mm						kN		r/min			
240	360	160	1.1	2*30*		329.5	1580	3850	1000	1300	NNF5048-2LS1NRV
260	400	190	1.1	3*30*		362.5	2180	4800	740	920	NNF5052-2LS1NRV
280	420	190	1.5	2*30*		384	2050	4910	680	840	NNF5056-2LS1NRV

Other dimensions			Contact surface and chamfer dimensions				Dimensions related to snap ring				Weight
d1	b	k	d _{amin}	D _{amax}	r _{amax}	r _{bmax}	B1	B2	b1	Ca	
mm			mm				mm				kg
279.5			248	352	2.0	1.0	142.6	8.2	6.3	130	60.7
309			275	392	3.0	1.0	168	10.5	8.1	154	92.4
326			288	410	2.0	1.5	168.2	10.4	8.1	154	95.8

Four-row Cylindrical Roller Bearing

d 90~140 mm

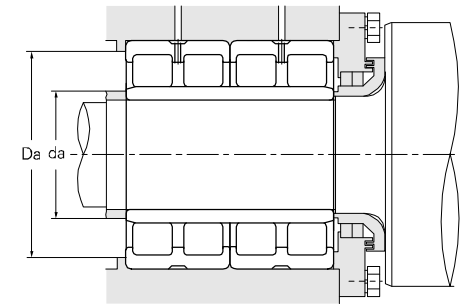
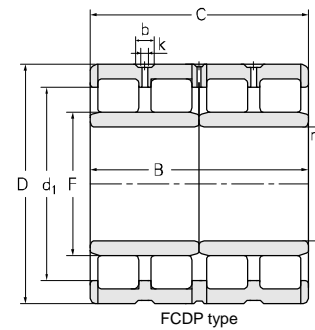
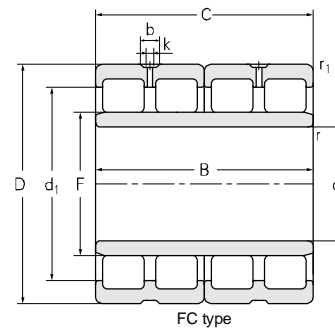
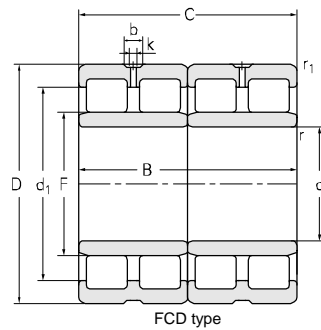

Principal dimensions							Basic load ratings	
d	D	B	C	r1min	rmin	F	Cr	Cor
mm							kN	
90	140	70	70	1.5	1.1	105	253	425
	140	70	70	1.1	1.5	105	275	425
	140	70	70	1.1	1.5	105	250	425
100	140	70	70	1.5	1.1	111	209	435
	140	70	70	1.5	1.1	111	228	435
	140	70	70	1.1	1.5	111	209	435
	140	70	70	1.1	1.5	111	210	435
	140	104	104	1.5	1.1	111	330	775
	140	104	104	1.1	1.5	111	396	870
	140	104	104	1.1	1.5	111	330	775
	140	104	104	1.5	1.1	111	360	870
	150	106	106	1.1	1.5	113	425	890
	150	106	106	1.1	1.5	113	425	890
110	170	120	120	2	2	127	583	1110
	170	120	120	2	2	127	534	1110
	170	120	120	2	2	127	530	1110
119.5	215	126	126	2	2	147	755	1350
120	165	90	90	1.5	1.5	132	400	860
	180	105	105	2	2	135	413	770
	180	105	105	2	2	135	561	1100
	180	105	105	2	2	135	410	770
130	200	125	125	2	2	149	583	1200
	200	125	125	2	2	149	638	1200
	200	125	125	2	2	149	580	1200
140	210	125	125	2	2	158	594	1160
	210	125	125	2	2	158	594	1050
	210	125	125	2	2	158	590	1160
	210	125	125	2	2	158	594	1050
	210	155	155	2	2	166	693	1610
	210	155	155	2	2	166	720	1680
	210	155	155	2	2	166	720	1680

Designations	Abutment and fillet dimensions				Weight
	D1min	bmax	kmax	Da da	
	mm				kg
FC182870	123	6.5	4	129 97	3.78
FC182870A	122.6	6.5	4	129 97	3.78
FC182870S	123	6.5	4	129 97	3.78
FC202870/YA3	125.4			129 106	3.10
NNQD6920X2/YB3	125.9			129 106	3.08
FC202870A/YA3	125.4			129 107	3.62
FC202870S/YA3	125.4			129 107	3.1
FC2028104	125.4	8	4	129 106	4.99
FC2028104A	125.4	8	4	129 107	4.99
FC2028104S	125.4	8	4	129 107	4.99
FCD2028104	125.4	8	4	129 106	4.99
FC2030106	132	8	4	140 107	6.67
FCD2030106/C9YB2	132	8	4	140 107	6.63
FC2234120A	149	6.5	4	158 118	10.1
FC2234120	149	6.5	4	158 118	10.1
FC2234120S	149	6.5	4	158 118	10.1
FC2443126X4ZW-XF	183.6	9	4	203 128	19.6
FC243390/YA34	151.2			154 126	5.59
FC2436105	160	6.5	4	168 128	9.13
FC2436105A	159	6.5	4	168 128	9.13
FC2436105S	160	6.5	4	168 128	9.13
FC2640125	174	6.5	4	188 138	14.6
FC2640125A	174	6.5	4	188 138	14.6
FC2640125S	174	6.5	4	188 138	14.6
FC2842125	188	9.5	5	198 148	14.7
FC2842125A	186.8	9.5	5	198 148	14.7
FC2842125S	188	9.5	5	198 148	14.7
FC2842125AF3	186.8	9.5	5	198 148	14.6
FC2842155K/C9YA3	190.9			198 148	18.1
FC2842155SK/C9YA3	190.9			198 148	18.1

Four-row Cylindrical Roller Bearing

d 145~160 mm

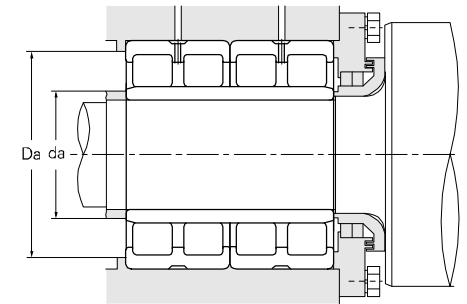
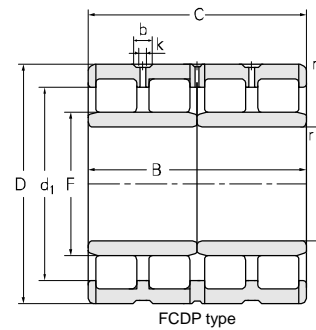
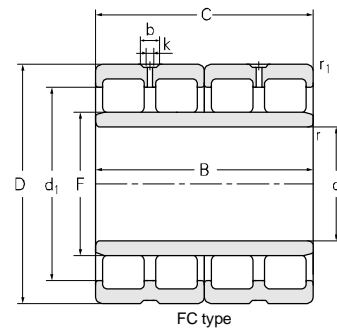
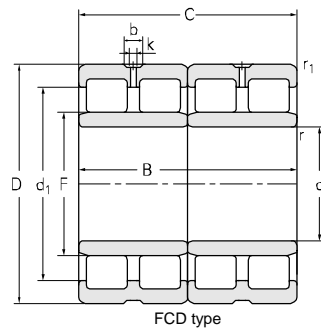

Principal dimensions							Basic load ratings		
d	D	B	C	r _{1min}	r _{min}	F	C _r	C _{or}	
mm							kN		
145	210	155	155	2	2	166	752	1610	
	210	155	155	2	2	166	754	1800	
	210	155	155	2	2	166	690	1610	
	210	155	155	1.1	1.1	166	752	1610	
	225	156	156	2	2	169	913	1800	
	225	156	156	2	2	169	913	1800	
150	210	120	120	2	2	166	570	1320	
	225	120	120	2	2	169	710	1450	
	225	120	120	2	2	169	809	1620	
	225	120	120	2	2	169	781	1450	
	225	120	120	2	2	169	710	1450	
	225	120	120	2	2	169	710	1450	
	225	150	150	2	2	169	900	1950	
	225	120	120	2	2	169	710	1450	
	230	156	156	2	2	174	852	1790	
	230	156	156	2	2	174	1010	2090	
	160	230	130	130	1.5	1.5	180	742	1705
		230	130	130	1.5	1.5	180	770	1620
230		130	130	1.5	1.5	180	680	1380	
230		130	130	1.5	1.5	180	660	1560	
230		168	168	2.1	2.1	180	852	2170	
230		168	168	2.1	2.1	180	897	2200	
230		168	168	2.1	2.1	180	900	2200	
230		168	168	2.1	2.1	179	940	2250	
230		168	168	2	1.1	182	855	2180	
240		124	124	2.1	2.1	183	810	1530	
240		124	124	2.1	2.1	183	810	1530	
240		124	124	2.1	2.1	183	810	1530	
240		124	124	2.1	2.1	183	810	1530	
240		124	124	2.1	2.1	183	760	1530	
240		124	124	2.1	2.1	183	760	1530	
240		124	124	2.1	2.1	183	685	1530	
240		124	124	2.1	2.1	183	685	1530	

Designations	Abutment and fillet dimensions				Weight	
	D _{1min}	b _{max}	k _{max}	Da		da
	mm				kg	
FC2942155/YA3	190.9			198	153	18.3
FC2942155A/YA3	190			198	153	18
FC2942155S/YA3	190.9			198	153	18.3
FC2942155	190.9			200	151	18.3
FC2945156/C3	197.8	9.5	5	213	153	23.6
FC2945156/YA3	197.8	9.5	5	213	153	23.6
FC3042120/YA3	188.5	8.1	4	198	158	12.9
FC3045120	200	9	4	213	158	16.7
FC3045120ZW/C9	202.4	9	4	213	158	17.9
FC3045120A	199.4	9	4	213	158	16.7
FC3045120S	200	9	4	213	158	16.7
FC3045120A/YA3	199.4	9	4	213	158	16.7
FC3045150/HCYA34	199.4	9.5	4	213	158	20.9
FCD3045120	199.4	9	4	213	158	16.6
FC3046156	204	9.5	5	218	158	23.6
FC3046156A	202.8	9.5	5	218	158	23.6
FC3246130	210			219	167	16.9
FC3246130A/YA3	210			219	167	17.3
FC3246130S	210			219	167	16.9
FC3246130/YA5	204	9	4	219	167	18.1
FC3246168/YA3	206.6			218	168	22.1
FC3246168A/YA3	205.6			218	168	22.3
FC3246168/W33YA3	205.6	9.5	4	218	168	22.3
FC3246168/YA34	204			218	168	23.4
FC3246168F3/C9YAD	207			218	168	23.5
FC3248124/C9	216	9	4	228	168	20.3
FC3248124	216	9	4	228	168	20.3
FC3248124A	215	9	4	228	168	20.3
FC3248124A/YA31	215	9	4	228	168	20.2
FC3248124/YA31	215	9	4	228	168	20.2
FC3248124S/YA31	216	9	4	228	168	20.2
FC3248124S	216	9	4	228	168	20.3
FC3248124A/YA3	215	9	4	228	168	20.3
FC3248124AF3	215	9	4	228	168	20.1

Four-row Cylindrical Roller Bearing

d 160~180 mm

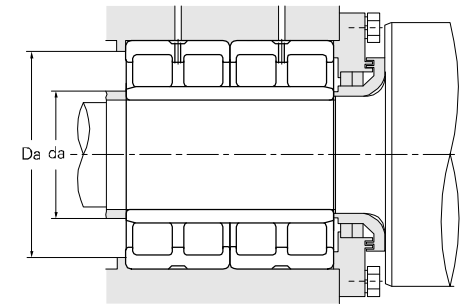
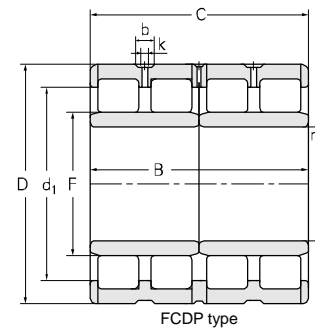
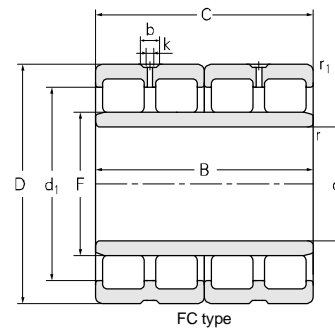
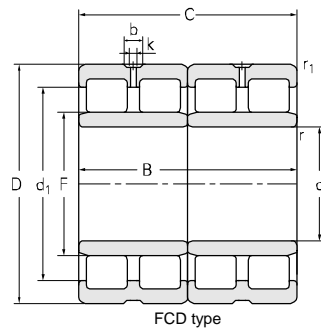

Principal dimensions							Basic load ratings		
d	D	B	C	r1min	rmin	F	Cr	Cor	
mm									
160	240	168	168	2.1	2.1	183	1060	2350	
	240	168	168	2.1	2.1	183	1060	2350	
	240	168	168	2.1	2.1	183	1240	2560	
	240	168	168	2.1	2.1	183	1060	2350	
165.1	225.425	168.275	168.275	1.5	1.5	181	950	1950	
170	230	160	160	2	2	185.5	1210	2360	
	230	160	160	2	2	185.5	1100	2360	
	230	160	160	2	2	185.5	935	2360	
	230	160	160	2	2	185.5	950	2390	
	230	160	160	2	2	185.5	950	2390	
	230	180	180	2	2	186	1010	2720	
	230	180	180	2	2	186	1010	2720	
	240	170	170	2.1	2.1	189	940	2390	
	240	170	170	2.1	2.1	189	940	2390	
	250	170	170	2.1	2.1	192	1280	2500	
	250	170	170	2.1	2.1	192	1100	2570	
	250	170	170	2.1	2.1	192	1090	2500	
	250	170	170	2.1	2.1	192	1280	2590	
	250	170	170	2.1	2.1	192	1380	2550	
	260	120	120	2.1	2.1	195	867	1790	
	260	120	120	2.1	2.1	195	867	1790	
260	120	120	2.1	2.1	195	840	1790		
260	150	150	2.1	2.1	195	1000	2240		
180	250	133	133	2	2	234	1050	1870	
	250	156	156	2.1	2.1	200	1210	1770	
	250	156	156	2	2	200	1210	2315	
	250	156	156	2.1	2.1	200	740	1770	
	250	156	156	2	2	198	785	1950	
	250	156	156	2	2	198	1220	1950	
	260	124	124	2.1	2.1	202	809	1730	
	260	124	124	2.1	2.1	202	810	1730	
	260	168	168	2.1	2.1	202	1180	2790	
	260	168	168	2.1	2.1	202	1180	2790	

Designations	Abutment and fillet dimensions					Weight
	D1min	bmax	kmax	Da	da	
mm						
FC3248168	216	10	5	228	168	26.4
FC3248168S	216	10	5	228	168	26.4
NNQD6032X2/C4	215	10	5	228	168	28.1
FC3248168A	215	10	5	228	168	26.4
FCD3345168X4/YA3	205			214	172	19.7
FCD3446160	211.5	7.5	3	218	178	20.0
FCD3446160AF3	211.1	7.5	3	218	178	18.6
FCD3446160S	211.5	7.5	3	218	178	20.0
FC3446160/YA34/W281	211.1	7.5	3	218	178	20.1
FC3446160/YA34	211.1	7.5	3	218	178	20.1
FC3446180/YAD	210	8	3	218	178	21.7
FC3446180/YA4	210	8	3	218	178	21.7
FC3448170/YAD	215	10	6	228	178	24.7
FC3448170/YA3	215	10	6	228	178	24.7
FC3450170	225	12	6	238	178	28.5
FC3450170AF3	224	12	6	238	178	28.5
FC3450170S	225	12	6	238	178	28.5
FC3450170Q1/HG2YA4	225	9.5	5	238	178	28.9
FC3450170A	224	12	6	238	178	28.8
FC3452120	228	9.5	5	246	178	24.6
FC3452120A	227	9.5	5	247	178	24.6
FC3452120S	228	9.5	5	246	178	24.6
FC3452150	227	9.5	5	247	178	29.7
NNQ6936X2V/YA7	234	12	6	238	190	18.2
FC3650156/C4YA4	226	9.5	6.5	238	188	22.7
FC3650156/YA34	226.8			238	188	23.9
FC3650156	226	9.5	6.5	238	188	22.7
FC3650156/YA3-1	226.8	9.5	5	238	188	23.6
FC3650156/YA3	226.8			244	188	23.7
FC3652124	234.8	9.5	5	248	188	21.7
FC3652124S	234.8	9.5	5	248	188	21.7
FC3652168	234.8	12	6	248	188	30.2
FC3652168/YA3	234.8	12	6	248	188	30.1

Four-row Cylindrical Roller Bearing

d 180~190 mm

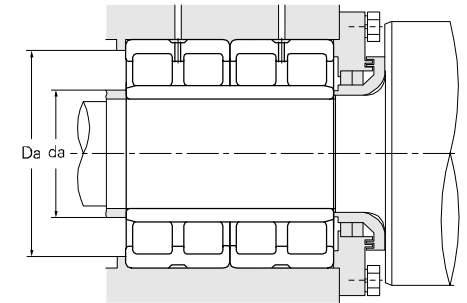
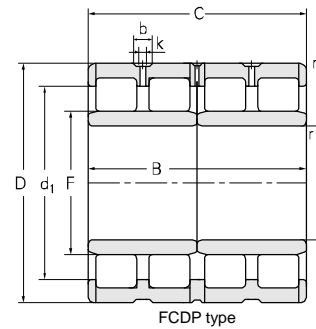
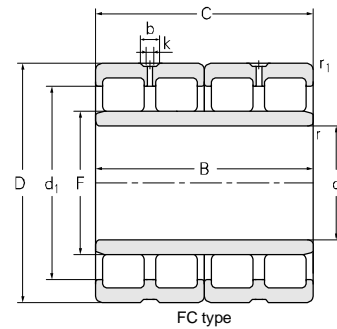
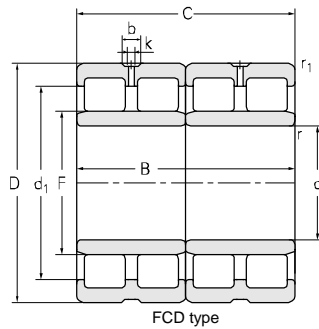

Principal dimensions							Basic load ratings		
d	D	B	C	r _{1min}	r _{min}	F	C _r	C _{or}	
mm									
180	260	168	168	2.1	2.1	202	1530	2790	
	260	168	168	2.1	2.1	202	1180	2790	
	260	168	168	2.1	2.1	202	1180	2790	
	260	168	168	2.1	2.1	202	1180	2790	
	260	168	168	2.1	2.1	202	1180	2790	
	260	168	168	2.1	2.1	202	1070	2790	
	260	168	168	2.1	2.1	202	1120	2700	
	260	168	168	2.1	2.1	202	1100	2660	
	260	168	168	2.1	2.1	202	1180	2790	
	260	168	168	2.1	2.1	202	1180	2790	
	260	168	168	2.1	2.1	202	1180	2790	
	260	168	168	2.1	2.1	202	1100	2660	
	260	168	168	2.1	2.1	202	1070	2790	
	260	168	168	2.1	2.1	202	1100	2660	
	260	180	180	2.1	2.1	202	1250	3000	
	260	180	180	2.1	2.1	202	1250	3000	
	260	168	168	2.1	2.1	202	1100	2660	
	280	180	180	2.1	2.1	207	1300	2800	
	280	180	180	2.1	2.1	207	1300	2800	
	190	260	168	168	2.1	2.1	212	1450	2600
260		168	168	2.1	2.1	212	1450	2600	
260		168	168	2.1	2.1	208	1000	2600	
260		168	168	2.1	2.1	212	1450	2600	
260		168	168	2.1	2.1	208	1000	2600	
260		168	168	2.1	2.1	212	1020	2750	
260		168	168	2.1	2.1	212	870	2600	
260		168	168	2.1	2.1	212	870	2600	
270		168	168	2.1	2.1	212	1050	2430	
270		168	168	2.1	2.1	212	1050	2430	
270		168	168	2.1	2.1	212	1420	2430	
270		168	168	2.1	2.1	212	1420	2430	
270		168	168	2.1	2.1	212	1420	2430	
270		168	168	2.1	2.1	212	1420	2430	
270		168	168	2.1	2.1	212	1420	2430	
270		168	168	2.1	2.1	212	1420	2430	
270		168	168	2.1	2.1	212	1420	2430	
270		168	168	2.1	2.1	212	1420	2430	

Designations	Abutment and fillet dimensions					Weight
	D _{1min}	b _{max}	k _{max}	Da	da	
mm						
FC3652168Q1/HG2YA4	234.8	9.5	5	248	188	30.6
FC3652168/C4YAD	232.4			248	188	30.1
FC3652168A	234	12	6	248	188	30.2
FC3652168A/YA3	234	12	6	248	188	30.1
FC3652168/YA31	237.6	9.5	5	248	188	30.1
FC3652168/YAD-2	232.4			248	188	30.1
FC3652168ZW/YA4	232.4			248	188	30.6
FC3652168F3/YA4-2	232.4			248	188	29.5
FC3652168S	234.8	12	6	248	188	30.2
FC3652168S/YA31	234.8	12	6	248	188	30.1
FC3652168S/YA3	234.8	12	6	248	188	30.1
FC3652168F3/YA4	232.4	12	6	248	188	29.1
FC3652168AF3	234	12	6	248	188	30
FC3652168/YA4-2	232.4			248	188	29.7
FC3652180S	234.8	12	6	248	188	31.5
FC3652180	234.8	12	6	248	188	31.5
FC3652168/YA4	232.4	12	6	248	188	29.3
FC3656180F3	246	9.5	5	268	188	42.0
FC3656180	246	9.5	5	268	188	42.0
FC3852168/YA3	237.6	9.5	5	248	198	23.1
FC3852168A	237.6	9.5	5	248	198	23.1
FC3852168/YAB	235	8.5	5	248	198	26.8
FC3852168/YA34	237.6	8	4	248	198	26.2
FC3852168/HG2YAB	235	9.5	5	248	198	26.8
FC3852168S	238.6	9.5	5	248	198	22.6
FC3852168F3/YA3-1	232.8	9.5	5	248	198	27.7
FC3852168/YAD	232.8	9.5	5	248	198	27.8
FC3854168AF3/YA3	244	9.5	5	248	198	30.4
FC3854168S/YA3	245.2	9.5	5	248	198	29.9
FC3854168	245.2	9.5	5	258	198	30.2
FC3854168/YA3	245.2	9.5	5	258	198	29.9
FC3854168Q1/HG2C9YA4	245.2	9.5	5	258	198	30.8
FC3854168A	244	9.5	5	258	198	31.9
FC3854168A/YA3	244	9.5	5	258	198	31
FC3854168AQ1/HG2C9YA4	244	9.5	5	258	198	30.8

Four-row Cylindrical Roller Bearing



d 190~200 mm

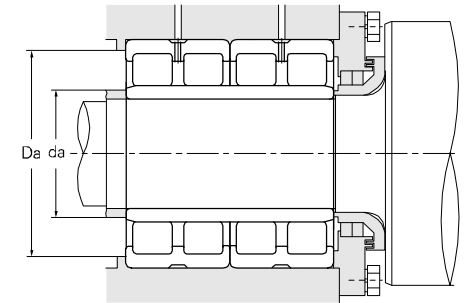
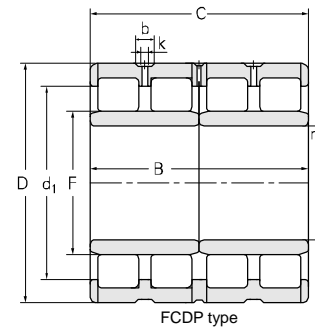
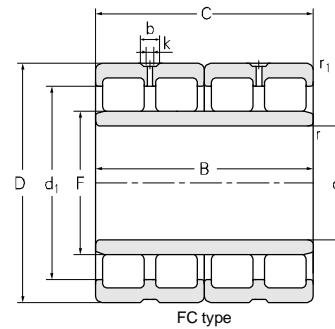
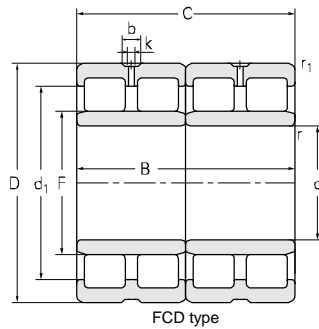

Principal dimensions							Basic load ratings		
d	D	B	C	r _{1min}	r _{min}	F	C _r	C _{or}	
mm									
190	270	170	170	2.1	2.1	212	1430	2430	
	270	170	170	2.1	2.1	212	1430	2650	
	270	170	170	2.1	2.1	212	1050	2430	
	270	200	200	2.1	2.1	212	1520	3180	
	270	200	200	2.1	2.1	212	1580	3275	
	270	200	200	2.1	2.1	212	1300	3200	
	270	200	200	2.1	2.1	212	1280	3150	
	200	270	170	170	2.1	2.1	222	1120	2270
270		170	170	2.1	2.1	222	1120	2270	
270		170	170	2.1	2.1	222	1120	2740	
270		170	170	2.1	2.1	222	910	2740	
270		170	170	2.1	2.1	222	910	2740	
270		170	170	2.1	2.1	222	950	2780	
270		170	170	2.1	2.1	222	910	2740	
270		170	170	2.1	2.1	222	950	2780	
270		170	170	2.1	2.1	222	1120	2740	
280		170	170	2.1	2.1	222	1110	3000	
280		170	170	2.1	2.1	222	1110	3000	
280		188	188	2.1	2.1	222	1430	2580	
280		188	188	2.1	2.1	222	1560	3000	
280		188	188	2.1	2.1	222	1220	3000	
280		200	200	2.1	2.1	222	1340	3400	
280		200	200	2.1	2.1	222	1400	3850	
280		200	200	2.1	2.1	222	1340	3400	
280		200	200	2.1	2.1	222	1340	3400	
290		192	192	2.1	2.1	226	1400	3400	
290		192	192	2.1	2.1	226	1430	3450	
290		192	192	2.1	2.1	226	1430	3450	
290		192	192	2.1	2.1	226	1400	3400	
290	192	192	2.1	2.1	226	1360	3695		
290	192	192	2.1	2.1	226	1460	3250		
290	192	192	2.1	2.1	226	1490	3300		
290	192	192	2.1	2.1	226	1460	3695		
290	192	192	2.1	2.1	226	1460	3350		
290	192	192	2.1	2.1	226	1400	3500		

Designations	Abutment and fillet dimensions					Weight
	D _{1min}	b _{max}	k _{max}	Da	da	
mm						
FC3854170/YA3	245.2	9.5	5	258	198	30.2
FC3854170A/YA3	244	9.5	5	258	198	31.8
FC3854170S/YA3	245.2	9.5	5	258	198	30.2
FC3854200	245.2	15	7	258	198	35.0
FC3854200A	244	15	7	258	198	35
FC3854200SQ1	245.2	15	7	258	198	35
FC3854200/YA5	244	15	5	258	198	33.4
FC4054170Q1/YA3	246.5	9.5	5	258	208	28.7
FC4054170Q1/HG2C4Y	246.5			258	208	28.7
FC4054170A/C4YA3	247.6	9.5	5	258	208	28.7
FC4054170/YAD-2	247.6	9.5	5	258	208	28.7
FC4054170AF3/YAB	247.6	9.5	5	258	208	28.5
FC4054170F3/YAD-1	244.4			258	208	29.1
FC4054170AF3/C4YA3	247.6	9.5	5	258	208	28.5
FC4054170/YAD-1	244.4			268	208	29.3
FC4054170/HCC4YA3	247.6	9.5	5	258	208	28.7
FC4056170F3	254	9.5	5	268	208	33.6
FC4056170	254	9.5	5	268	208	33.3
FC4056188	255	9.5	5	268	208	35.7
FC4056188A	254	9.5	5	268	208	35.9
FC4056188S	255	9.5	5	268	208	35.7
FC4056200F3/YA3	254	9.5	5	268	208	38.3
FC4056200ZW/YAD	250.8			268	208	39.7
FC4056200/YAD-1	254			268	208	39
FC4056200/YAD	254	9.5	5	268	208	38.8
FC4058192F3/YAD	261			278	208	41.6
FC4058192S	262	15	6	278	208	40.9
FC4058192S/YA4	261	15	6	278	208	40.9
FC4058192F3/YA34/W281	261	15	6	278	208	41.6
FC4058192AF3	261	15	6	278	208	40.7
FC4058192	262	15	6	278	208	40.9
FC4058192/YA4	261	15	6	278	208	40.9
FC4058192A	261	15	6	278	208	40.9
FC4058192A/YA4	261	15	6	278	208	41.3
FC4058192ZWF3/YA34	258			278	208	44.6

Four-row Cylindrical Roller Bearing

d 200~220 mm

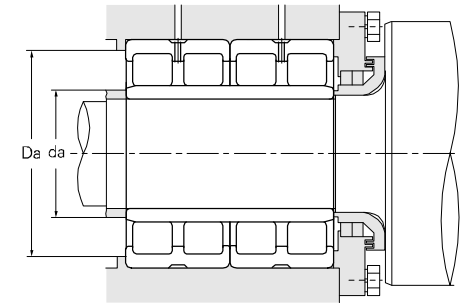
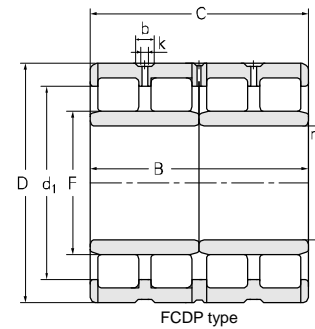
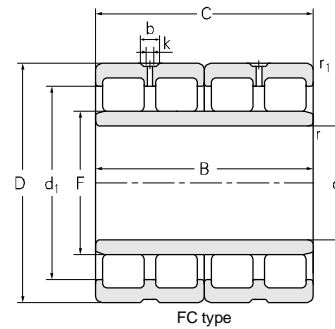
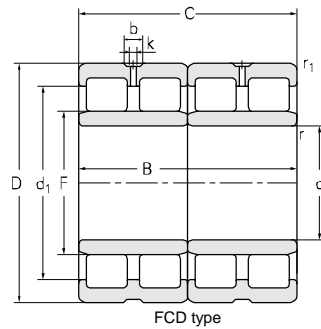

Principal dimensions							Basic load ratings		
d	D	B	C	r _{1min}	r _{min}	F	C _r	C _{or}	
mm									
200	290	192	192	2.1	2.1	226	1430	3450	
	310	175	175	2.1	2.1	229	1420	3050	
199.86	280	170	170	2.1	2.1	222	1110	3000	
210	300	210	210	2.1	2.1	234	1560	3950	
	300	210	210	2.1	2.1	234	1560	3950	
	300	210	210	2.1	2.1	234	1780	4140	
	300	210	210	2.1	2.1	234	1780	4140	
	300	210	210	2.1	2.1	234	1620	4150	
	300	210	210	2.1	2.1	234	1620	4150	
	300	210	210	2.1	2.1	234	1625	4140	
	300	170	170	2.1	2.1	234	1320	3150	
	300	260	260	2.1	2.1	234	2100	4670	
	220	300	192	192	2.5	2.5	242	1280	3390
300		192	192	2.5	2.5	242	1290	3300	
300		192	192	2.5	2.5	242	1280	3390	
300		192	192	2.5	2.5	245	1360	3700	
300		190	192	2.5	2.5	242	1150	3250	
300		192	192	2.5	2.5	242	1280	3390	
310		192	192	2.1	2.1	246	1600	1910	
310		192	192	2.1	2.1	246	1600	1910	
310		192	192	2.1	2.1	246	1600	3600	
310		192	192	2.1	2.1	246	1600	3600	
310		192	192	2.1	2.1	246	1320	3600	
310		192	192	2.1	2.1	246	1480	3750	
310		192	192	2.1	2.1	246	1480	3750	
310		192	192	2.1	2.1	246	1480	3750	
310		192	192	2.1	2.1	246	1320	3600	
310		225	225	2.1	2.1	246	1600	4400	
310		225	225	2.1	2.1	246	1500	4000	
310		225	225	0.6	2.1	244	1850	4050	
310		265	265	2.1	2.1	246	1800	4850	
320		210	210	2.1	2.1	248	1900	3800	
320	210	210	2.1	2.1	248	1900	4000		

Designations	Abutment and fillet dimensions					Weight
	D _{1min}	b _{max}	k _{max}	Da	da	
mm						
FC4058192/HG2YAD	262	15	6	278	208	40.9
FC4062175/YA3	270.6	9.5	5	297	208	49.8
FC4056170X4/YA3	254			268	208	33.3
FC4260210	271	9.5	5	288	218	48.3
FC4260210A	271	9.5	5	288	218	48.3
FC4260210A/C9YA4	269	9.5	5	288	218	48.3
FC4260210S	269	9.5	5	288	218	48.3
FC4260210S/C9YA4	271	9.5	5	288	218	48.3
FC4260210/YA34	269	9.5	5	288	218	48.3
FC4260170	269	9.5	5	288	218	39.1
FC4260260	269	9.5	5	288	218	58.9
FC4460192/YA34-1	272	9.5	4	287	229	39.6
FC4460192F3/YA4	274	9.5	5	287	229	38.5
FC4460192F3	272	9.5	5	287	229	39.6
FC4460192ZW	275	9	4	288	235	43.4
FC4460192F3/C4YA4	274	9.5	5	287	229	38.9
FC4460192/YA4-1	272	9.5	5	287	229	39.8
FC4462192/YA3	282.5	15	6	298	228	45.8
FC4462192	282.5	15	6	298	228	45.8
FC4462192A	281.2	15	6	298	228	46.2
FC4462192A/YA3	281.2	15	6	298	228	46.1
FC4462192A/YA1	281.2			298	228	46.1
FC4462192F3	282.5	15	6	298	228	45.3
FC4462192S	282.5	15	6	298	228	45.8
FC4462192S/YA3	282.5	15	6	298	228	45.7
FC4462192AF3	281.2	15	6	298	228	45.9
FC4462225F3/HCYA4	278	9.5	5	298	228	54.4
FC4462225F3/YA3	278	5.5	3.5	298	228	54
FC4462225	280			300	228	53.9
FCD4462265	281.2	9.5	5	298	228	63.3
FC4464210/YA3	287			308	228	56.5
FC4464210A/YA3	286.4			308	228	58.2

Four-row Cylindrical Roller Bearing

d 220~240 mm

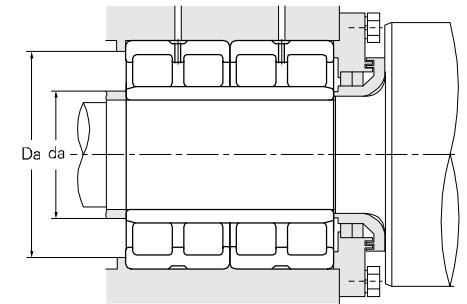
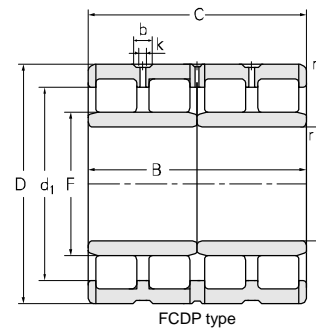
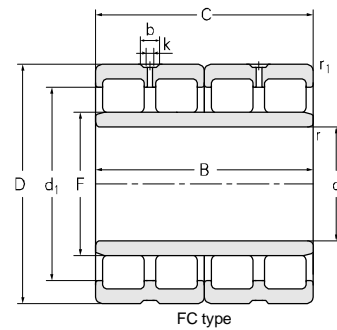
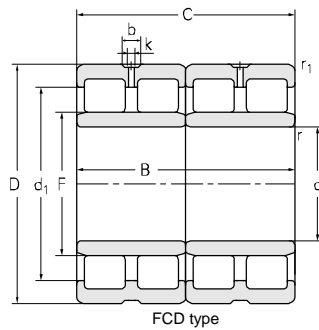

Principal dimensions							Basic load ratings		
d	D	B	C	r _{1min}	r _{min}	F	C _r	C _{or}	
mm									
220	320	210	210	2.1	2.1	248	1500	4000	
	320	210	210	2.1	2.1	248	1500	4000	
	320	210	210	2.1	2.1	248	1500	4000	
	320	210	210	2.1	2.1	248	1640	4000	
	320	210	210	2.1	2.1	248	1900	4000	
	340	200	200	4	4	250	1950	3550	
	340	192	192	2.1	2.1	250	1620	3390	
	224.88	310	225	225	2.1	2.1	244.7	1260	3030
230	330	170	170	2.1	2.1	260	1250	3100	
	330	170	170	2.1	2.1	260	1250	3100	
	330	206	206	2.1	2.1	260	1780	3800	
	330	206	206	2.1	2.1	258	1880	4350	
	330	206	206	2.1	2.1	260	1500	4350	
	330	206	206	2.1	2.1	260	1880	4350	
	330	206	206	2.1	2.1	260	1500	4350	
	330	206	206	2.1	2.1	260	1540	4000	
	330	206	206	2.1	2.1	260	1500	4350	
	330	206	206	2.1	2.1	260	1500	4350	
	330	206	206	2.1	2.1	260	1540	4000	
	330	206	206	2.1	2.1	260	1500	4350	
	330	206	206	2.1	2.1	260	1500	4350	
	330	206	206	2.1	2.1	260	1500	4350	
	330	206	206	2.1	2.1	260	1540	4000	
	330	206	206	2.1	2.1	260	1500	4350	
	330	206	206	2.5	2.5	257	1880	3900	
	330	206	206	2.1	2.1	260	1880	4350	
	340	260	260	2.1	2.1	261	2120	5350	
	340	260	260	2.1	2.1	261	2120	5350	
340	260	260	2.1	2.1	261	2120	5350		
340	260	260	2.1	2.1	261	2120	5350		
340	260	260	2.1	2.1	261	2120	5350		
365	250	250	2.1	2.1	266	2400	5400		
240	330	220	220	2.1	2.1	264	1780	4850	

Designations	Abutment and fillet dimensions					Weight
	D _{1min}	b _{max}	k _{max}	Da	da	
mm						
FC4464210F3/YA3	286.4	12.5	5	308	228	57.2
FC4464210/QPC9W33XYAB	286.4	9.5	5	308	228	57.6
FC4464210/YA3W33	286.4	12.5	5	308	228	57.6
FC4464210S/YA3	287			308	228	56.5
FCD4464210	286.4	9.5	5	308	228	57.1
FC4468200/YB2	308.3	15	6	324	232	63.4
FC4468192/YA3	287	9.5	5	328	228	64.6
FCD4562225X4/YA3	278			298	233	50.4
FC4666170/YAD-1	295			317	238	49.6
FC4666170/YAD	295			317	238	49.6
FC4666206/YA3	296	9.5	5	318	238	56.5
FC4666206/C4YAD	293			316	238	59.1
FC4666206/YAD-3	295	9.5	5	317	238	57.8
FC4666206A/YA3	295	9.5	5	317	238	57.8
FC4666206/YAB	295	9.5	6	317	238	57.8
FC4666206F1/HCOYA34/W281	295	9.5	5	317	238	57.5
FC4666206S/YA3	296	9.5	5	318	238	56.5
FC4666206F3/YA34/W281	295	9.5	5	317	238	58.2
FC4666206F1/YA34/W281	295	9.5	5	317	238	58.2
FC4666206AF3/YA3	265	9.5	5	317	238	57.5
FC4666206/YA34/W283	295	9.5	5	317	238	57.8
FC4666206F1/P64YAD	297			318	238	58.4
FC4666206/YAD-4	295			317	238	57.8
FC4666206/YA4	295.6	9.5	5	317	239	58.3
FC4666206/YA34	295	9.5	5	318	238	57.8
FC4668260/HCYA3	303	9.5	5	328	238	82.1
FC4668260/HCYA3-SY	303	9.5	5	328	238	82.1
FC4668260/C9YA3	303	8.5	5	328	238	81.9
FC4668260/YA3	303	8.5	5	328	238	82.1
FC4668260/YA3-SY	303	9.5	5	328	238	82.1
FC4673250F3/W281	317.2	9.5	5	352	238	102
FC4866220/YA3	301	9.5	5	317	248	56.5

Four-row Cylindrical Roller Bearing

d 240~260 mm

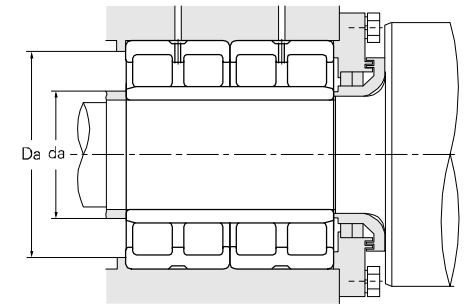
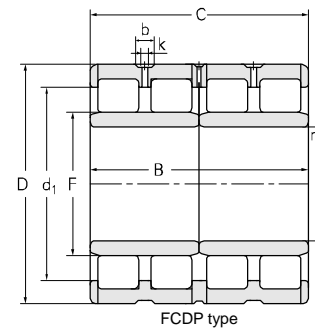
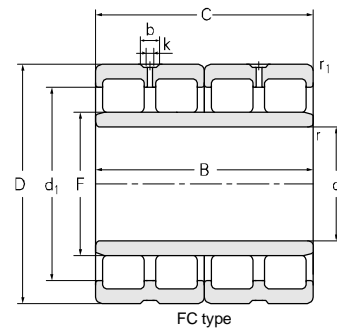
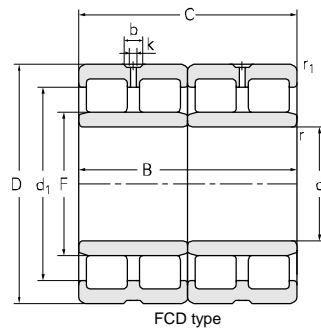

Principal dimensions							Basic load ratings	
d	D	B	C	r _{1min}	r _{min}	F	C _r	C _{or}
mm								kN
240	330	220	220	2.1	2.1	264	1780	4850
	330	220	220	2.1	2.1	264	1960	5335
	330	220	220	2.1	2.1	264	1960	5335
	330	220	220	2.1	2.1	264	1960	5335
	330	220	220	2.1	2.1	264	1780	4850
	330	220	220	2.1	2.1	264	1780	4850
	340	192	192	2.1	2.1	265	1440	3380
	340	192	192	2.1	2.1	265	1540	3650
	340	192	192	2.1	2.1	266	1560	3850
	350	224	224	3	3	270	1850	4600
	360	200	200	2.1	2.1	272	1870	4410
	360	220	220	2.5	2.5	272	1870	4410
	360	220	220	2.1	2.1	272	2430	4410
	360	220	220	2.1	2.1	272	1930	4600
	360	220	220	2.1	2.1	272	2530	4850
	360	220	220	2.1	2.1	272	1950	4600
	360	220	220	2.1	2.1	272	1750	4600
	360	220	220	2.1	2.1	272	1880	4400
	360	220	220	2.1	2.1	272	1880	4400
	360	220	220	2.1	2.1	272	1950	4600
	360	220	290	4	4	270	2460	5940
250	340	230	230	3.5	3.5	276	1750	4700
	350	220	220	3	3	278	1740	4980
	350	220	220	3	3	278	1840	4980
	350	220	220	3	3	278	1740	4450
	350	220	220	3	3	278	2160	4980
	360	220	220	3	3	282	1650	4250
	360	220	220	3	3	282	1710	4670
	360	220	220	3	3	282	1650	4250
	360	220	220	3	3	282	1900	5350
	360	220	220	3	3	282	1900	5350
260	360	200	200	3	3	288	2000	4650
	360	200	200	3	3	288	2000	4650
	360	200	200	3	3	288	1770	4650

Designations	Abutment and fillet dimensions				Weight	
	D _{1min}	b _{max}	k _{max}	Da		da
	mm				kg	
FC4866220	301			317	248	56.7
FC4866220A	299			316	248	57.1
FC4866220A/HG2	299			316	248	57.1
FC4866220A/YA3	299			316	248	56.8
FC4866220S/YA3	301			317	248	56.5
FCD4866220	299	9.5	5	316	248	57.1
FC4868192A1	308	9.5	5	327	248	52.8
FC4868192A	305	9.5	5	325	248	54.7
FC4868192/YA4	305.5	9.5	5	327	248	55.5
FC4870224/HG2YAD	310	9.5	6	336	250	75.1
FC4872220	318	12	6	346	248	78.0
FC4872220A/C4YA3	320			348	249	78.0
FC4872220Q1/HG2YA4	320	9.5	5	348	248	78.4
FC4872220A	316.8	12	6	346	248	79.1
FC4872220AQ1/HG2YA4	316.8	12	6	346	248	79.1
FC4872220/YA34	316.8	9.5	5	346	248	80.1
FC4872220AF3	316.8	12	6	346	248	78.7
FC4872220S	318	12	6	347	248	78
FC4872220SA1/C4YA3	320			348	248	78
FC4872220/YA3/W283	316.8	9.5	6	346	248	79.1
FCD4872290/YAD	318	9.5	5	347	252	102
FCD5068230/HCOYA34	312	9.5	5	325	261	60.8
FC5070220/YA3	316	9.5	5	336	260	65.5
FC5070220A/YA3	316.4	9.5	5	336	260	67.5
FC5070220S/YA3	316	9.5	5	336	260	65.5
FC5070220/HCYA3	316.4	9.5	5	336	260	67.5
FC5072220/YA3	320	9.5	5	346	260	76.9
FC5072220A/YA3	320	9.5	5	346	260	76.8
FC5072220S/YA3	320	9.5	5	346	260	76.9
FC5072220ZW/HCO	317.2	9.5	5	346	270	80.5
FC5072220ZW	317.2	9.5	5	346	260	80.5
FC5272200/YA3B2	328	9.5	5	346	272	63.0
FC5272200A/YA3B2	326	9.5	5	346	272	63
FC5272200/YA34	326	9.5	5	346	272	63

Four-row Cylindrical Roller Bearing

d 260~280 mm

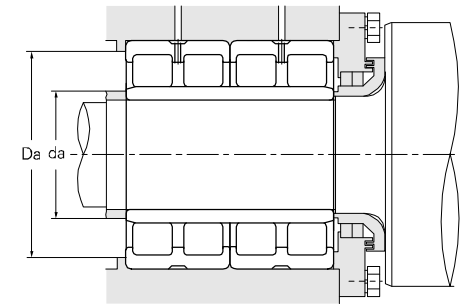
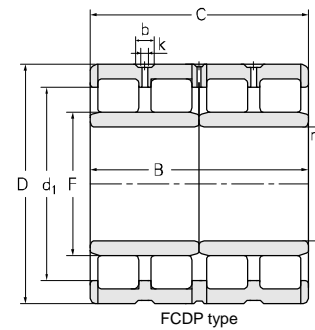
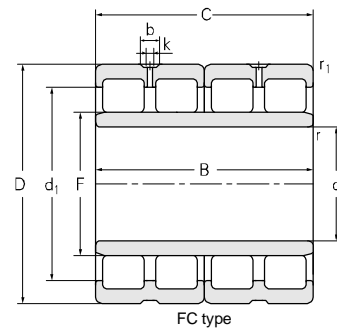
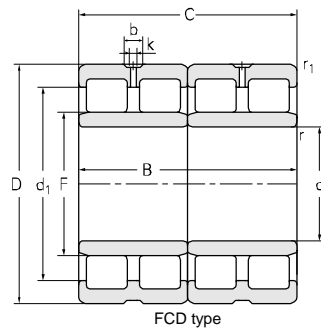

Principal dimensions							Basic load ratings		
d	D	B	C	r _{1min}	r _{min}	F	C _r	C _{or}	
mm							kN		
260	360	200	200	3	3	292	1730	4250	
	360	200	200	3	3	288	1690	4650	
	370	200	200	3	3	290	1710	4100	
	370	200	200	3	3	292	2050	4250	
	370	200	200	3	3	292	2150	4250	
	370	220	220	3	3	292	2100	4900	
	370	220	220	3	3	292	2100	4900	
	370	220	220	3	3	292	2150	4900	
	370	220	220	3	3	292	2100	4800	
	370	220	220	3	3	292	1840	4900	
	370	220	220	3	3	292	1960	5000	
	370	220	220	3	3	292	1680	4400	
	370	220	220	3	3	292	1930	4900	
	370	220	220	3	3	292	1930	4900	
	370	220	220	3	3	292	1810	4800	
	370	220	220	3	3	292	1810	4800	
	370	220	220	3	3	292	2100	4900	
	380	220	220	3	3	290	2150	4750	
	380	280	280	3	3	294	2640	6050	
	380	280	280	3	3	294	2640	6050	
	380	280	280	3	3	294	2640	6050	
	380	280	280	3	3	294	2640	6050	
	380	280	280	3	3	294	2640	6050	
	400	290	290	4	4	296	1800	1720	
270	380	230	230	3	3	298	1890	4800	
	380	230	230	3	3	298	1970	4800	
	380	230	230	3	3	298	1970	4800	
	380	230	230	3	3	298	2010	5000	
	380	230	230	3	3	298	1930	4800	
	380	230	230	3	3	298	1930	4800	
	380	230	230	3	3	298	1970	4800	
	390	236	236	3	3	312	2100	5950	
	390	236	236	3	3	312	2310	5950	
	390	236	236	3	3	312	2310	5950	
280	375	200	200	3	3	306	1700	4800	

Designations	Abutment and fillet dimensions					Weight
	D _{1min}	b _{max}	k _{max}	Da	da	
	mm					kg
FC5274200S	335.2	15	6	346	272	73
FC5272200S/YA3B2	328	9.5	5	346	272	63
FCD5274200/C4YA3	332			356	272	73
FC5274200	335.2	15	6	356	272	73.0
FC5274200A	333.6	15	6	356	272	73.8
FC5274220/YA3	335.5	9.5	5	356	272	79.2
FC5274220	335.5	9.5	5	356	272	80.0
FC5274220A	333.6	9.5	5	356	272	80.4
FC5274220A/YA4	330	9.5	5	356	272	78.7
FC5274220F3/YA4-1	330	9.5	5	356	272	78.2
FC5274220F3/YA3	335.5	9.5	5	356	272	78.7
FC5274220S/YA4	330	9.5	5	356	272	81
FC5274220S/YA3	335.5	9.5	5	356	272	79.2
FC5274220S	335.5	9.5	5	356	272	80
FC5274220/YA4-1	330	9.5	5	356	272	78.7
FC5274220A/YAD	330			356	272	79.7
FC5274220/YA34	335.5	9.5	5	356	272	79.6
FC5276220/C4YA4	332			366	272	87.9
FC5276280/YA3-SY	335.6	8.5	5	366	272	111
FC5276280/YA3	335.6	8.5	5	366	272	111
FC5276280/HCYA3	335.6	9.5	5	366	272	111
FC5276280/HCYA3-SY	335.6	9.5	5	366	272	111
FCD5280290/P63YA3	352	9.5	5	384	274	136
FC5476230/YA3	346	9.5	5	366	282	80.2
FC5476230A	342.8	9.5	5	366	282	82.1
FC5476230A/YA3	342.8	9.5	5	366	282	81.9
FC5476230AF3/YA3	342.8	9.5	5	366	282	81.3
FC5476230S-XXZG	346	9.5	5	366	282	80.5
FC5476230S	346	9.5	5	366	282	80.5
FC5476230/YA3-1	342.8	9.5	5	366	282	81.9
FC5478236S	352	9.5	5	376	282	97.8
FC5478236	352	9.5	5	376	282	97.8
FC5478236A	350.4	9.5	5	376	282	98.3
FC5675200/YA3	341	9.5	5	361	292	62.9

Four-row Cylindrical Roller Bearing

d 280~290 mm

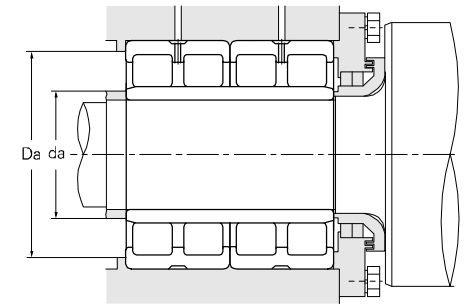
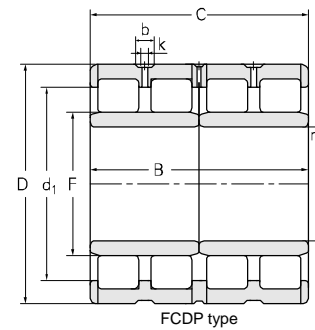
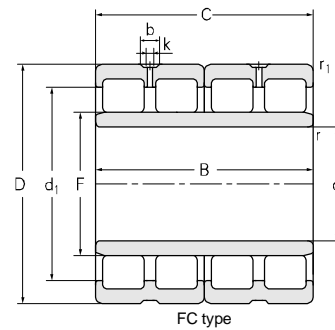
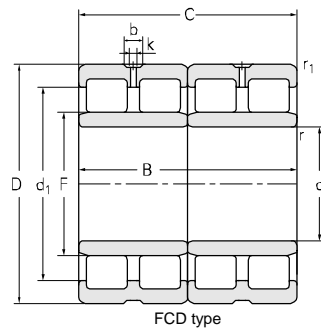

Principal dimensions						Basic load ratings		
d	D	B	C	r _{1min}	r _{min}	F	C _r	C _{or}
mm								kN
280	390	220	220	3	3	312	2130	5150
	390	220	220	3	3	312	2130	5200
	390	220	220	3	3	312	1980	5200
	390	220	220	3	3	312	2680	5000
	390	220	220	3	3	312	2130	5200
	390	220	220	3	3	312	2440	5000
	390	220	220	3	3	312	1650	5100
	390	240	240	3	3	312	2570	5850
	390	240	240	3	3	312	2570	5850
	390	220	220	3	3	312	1980	5200
	390	220	220	3	3	312	1900	5200
	390	220	220	3	3	312	1900	5200
	390	275	275	3	3	308	2360	6650
	390	275	275	3	3	308	2360	6650
	390	275	275	3	3	308	2360	6650
	390	275	275	3	3	308	2360	6650
	390	275	275	3	3	308	2360	6650
	390	275	275	3	3	308	2360	6650
	390	275	275	3	3	308	2360	6650
	390	275	275	1.5	1.1	308	2360	6650
	390	275	275	3	3	308	2360	6650
	390	240	240	3	3	312	2570	5850
	390	240	240	3	3	312	2570	5850
	390	240	240	3	3	312	2570	5850
	390	240	240	3	3	312	2570	5850
	390	220	220	3	3	312	2300	5100
	390	220	220	3	3	312	2300	5100
	390	275	275	3	3	308	2360	6650
	390	275	275	3	3	312	2300	6860
	400	244	244	7.5	4	312	2300	6000
	410	300	300	4	4	313	2760	7570
	420	280	280	4	4	318	3500	7000
290	410	240	240	4	4	320	2340	5900

Designations	Abutment and fillet dimensions				Weight	
	D _{1min}	b _{max}	k _{max}	Da		da
mm						
FC5678220	355.5	12	6	376	292	86.5
FC5678220A	350.4	12	6	376	292	89
FC5678220S	355.5	12	6	376	292	86.5
FC5678220/YA3	355.5	12	6	376	292	86.6
FC5678220A/YA3	350.4	12	6	376	292	88.6
FC5678220S/YA3	355.5	12	6	376	292	86.3
FC5678220AF3/C4YAB	355.5	12	6	376	292	88.2
FC5678240/YAD	355.5	12	6	376	292	90.4
FC5678240/YA34-1	354.5	12	6	376	292	90.4
FC5678220F3	355.5	12	6	376	292	83.4
FC5678220/C4HYAD-2	350.4	12	6	376	292	88.6
FC5678220/YAD-1	350.4	12	6	376	292	88.6
FCD5678275/YA3	348	9.5	5	376	292	105
FCD5678275F1/HCOYA34-1/W281	348	9.5	5	376	292	105
FCD5678275F3/YA34-1/W281	348	9.5	5	376	292	104
FCD5678275F1/YA34-1/W281	348	9.5	5	376	292	104
FCD5678275F3/YA34-1	348	9.5	5	376	292	104
FCD5678275F3/HCOYA34-1	348	9.5	5	376	292	104
FCD5678275/HCOYA34-1	348	9.5	5	376	292	105
FCD5678275	348	9.5	5	376	292	105
FCDP5678275	354.2	9.5	5	379	288	102
FCD5678275/C3YA34	352.8	9.5	5	376	292	102
FC5678240	354.5	12	6	376	292	90.4
FC5678240/HCOYA34	354.5	12	6	376	292	90.4
FC5678240/YA34	354.5	12	6	376	292	90.4
FC5678240/YA3	354.5	12	6	376	292	90.4
FC5678220/HCOYAD	352.3			376	292	83
FC5678220F1/HCC4YAD	352.3			376	292	83
FCD5678275/YA34-1	348	9.5	5	376	292	105
FC5678275/YA4	351	9.5	5	376	292	106
FCD5680244F3/YAD	357	15	8	377	294	102
FCD5682300-KM	359.2	15	6	394	294	140
FC5684280	373	12	6	404	294	139
FC5882240/C4YA3	368	15	8	394	304	102

Four-row Cylindrical Roller Bearing

d 290~320 mm

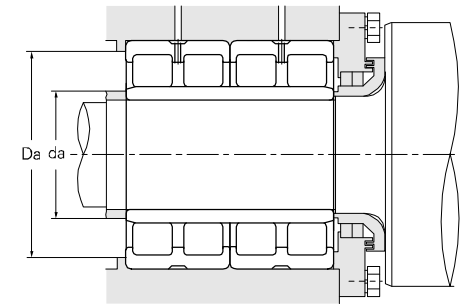
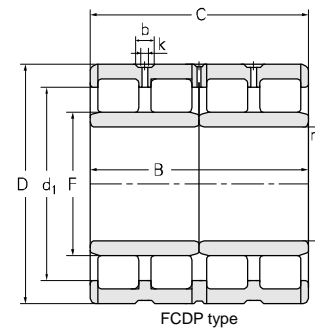
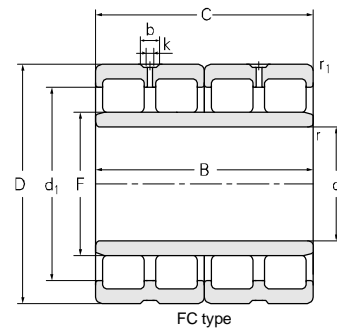
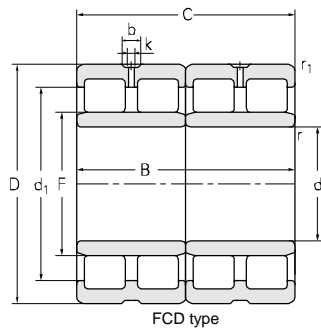

Principal dimensions							Basic load ratings		
d	D	B	C	r _{1min}	r _{min}	F	C _r	C _{or}	
mm									
290	420	300	300	4	4	327	2800	7850	
	430	280	280	4	4	330	2900	7400	
300	420	218	218	4	4	332	2270	5700	
	420	218	218	4	4	332	2270	5700	
	420	240	240	4	4	332	2450	6300	
	420	240	240	4	4	332	2450	6300	
	420	240	240	4	4	332	2450	6300	
	420	240	240	4	4	332	2400	6300	
	420	240	240	4	4	332	2500	6600	
	420	240	240	4	4	332	2550	6800	
	420	240	240	4	4	332	3450	6300	
	420	240	240	4	4	332	3450	6300	
	420	240	240	4	4	332	3450	6300	
	420	240	240	4	4	332	3450	6300	
	420	240	240	4	4	332	3450	6300	
	420	240	240	4	4	332	2500	6600	
	420	300	300	3	3	332	3550	6800	
	420	300	300	3	3	332	3550	6800	
	420	300	300	3	3	332	2270	6800	
	420	300	300	3	3	332	3750	8800	
	420	300	300	3	7*20*	332	3750	8800	
	420	300	300	3	3	332	2650	6950	
	420	300	300	3	3	332	2270	6800	
	420	300	300	3	3	332	2850	7700	
	420	300	300	3	3	332	2570	6680	
	420	300	300	3	7*20*	332	3750	8800	
	420	300	300	3	7*20*	332	3750	8800	
	420	300	300	3	3	332	3550	6800	
	460	350	350	4	5	340	4100	10500	
	460	350	350	4	5	340	4100	10500	
320	440	240	240	4	4	351	2550	6700	
	450	240	240	4	4	355	2760	6720	
	450	240	240	4	4	355	2970	6720	
	450	240	240	4	4	355	2700	6720	
	450	240	240	4	4	355	2630	7050	
	450	240	240	4	4	355	2760	6720	

Designations	Abutment and fillet dimensions					Weight
	D _{1min}	b _{max}	k _{max}	Da	da	
mm						
FCD5884300	371.8	12	6	404	304	144
FCD5886280F3/HG2	381.2	12	6	414	304	143
FC6084218F3/YA4	380	9.5	5	404	314	93.7
FC6084218/YA4	380	9.5	5	404	314	94.3
FC6084240AF3/YA3	380	15	8	404	314	103
FC6084240S	382	15	8	404	314	111
FC6084240S/YA3	382	15	8	404	314	111
FCD6084240/P6YAB	380	15	8	404	314	109
FC6084240ZW/YA3	381			402	322	110
FCD6084240ZW/YAB	379.5			404	316	110
FC6084240	382			404	314	111
FC6084240YA3	382	15	8	404	314	111
FC6084240A	380	15	8	404	314	111
FC6084240A/YA3	380	15	8	404	314	111
FC6084240/HCYA3	380	15	8	404	314	104
FCD6084300/YA34	382	12	6	406	312	129
FCD6084300/YA3	382	12	6	406	312	129
FCD6084300/W33AYA3	382	12	6	406	312	127
FCDP6084300F3/HCYAD	479.4	12	6	406	312	133
FCDP6084300F3/YAD	379.4	12	6	406	312	133
FCD6084300/HCYA4	382	12	6	406	312	129
FCD6084300F3/YA3	382			406	312	128
FCD6084300F1/YAD	382	15	6	406	312	135
FCD6084300/HCC4YA3/W283	382	12	6	406	312	127
FCDP6084300F1/YAD	379.4	12	6	406	312	133
FCDP6084300WB/HCYAD	379.4	12	6	406	312	137
FCD6084300/HC	382	12	6	406	312	129
FCD6092350ZWF3/HCYAD	399	20	10	444	316	226
FCD6092350ZWF3/HG2YAD	399	20	10	444	316	226
FCD6488240	399	12	6	422	336	110
FC6490240/YA3	412	12	6	432	336	119
FC6490240/C4YA3	409.4	12	6	432	336	120
FC6490240/YAD-1	409.4	12	6	432	336	120
FC6490240F3/YAD	403	12	6	432	336	122
FC6490240/YA34	412	12	6	432	336	120

Four-row Cylindrical Roller Bearing

d 320~340 mm

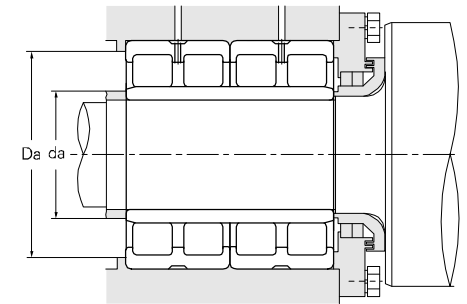
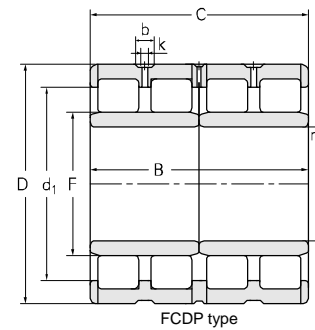
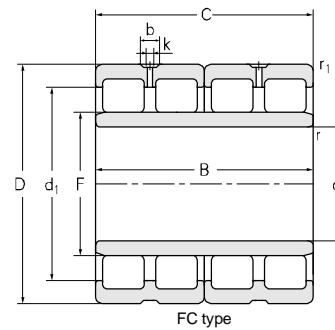
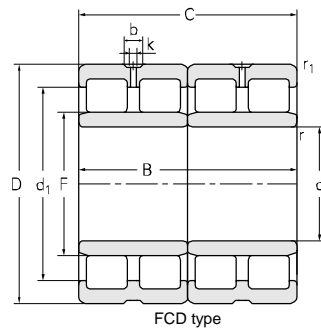

Principal dimensions				Basic load ratings					
d	D	B	C	r _{1min}	r _{min}	F	C _r	C _{or}	
								kn	
320	460	240	240	3	3	364	2710	7550	
	460	280	280	4	4	357	2900	7650	
	460	340	340	4	4	357	3700	10000	
	460	340	340	4	4	357	3700	10000	
	450	240	240	4	4	355	2760	6720	
	460	240	240	3	3	364	3370	7550	
	460	240	240	3	3	364	2700	7050	
	460	240	240	3	3	364	2700	7050	
	480	306	306	4	4	364	3950	8250	
	480	350	350	4	4	364	5150	10500	
	480	306	306	4	4	364	3950	8250	
	480	350	350	4	4	364	5150	10500	
	330	460	340	340	4	4	365	3550	9950
		460	340	340	4	4	365	3550	9950
340	450	250	250	4	4	371	2420	7250	
	450	250	250	4	4	371	2420	7500	
	450	250	250	4	4	371	2420	7250	
	450	250	250	4	4	371	2420	7250	
	450	250	250	4	4	371	2430	6800	
	450	250	250	4	4	370	2430	6800	
	450	250	250	4	4	370	2430	6800	
	450	250	250	4	4	369	2430	6820	
	450	250	250	4	4	369	2430	6820	
	450	250	250	4	4	369	2430	6820	
	450	250	250	4	4	366	2460	7250	
	450	250	250	4	4	371	2400	7250	
	450	250	250	4	4	371	2400	7250	
	450	260	260	4	4	370	2760	7600	
	480	350	350	4	4	378	3750	10600	
	480	350	350	4	4	378	3200	10300	
	480	350	350	4	4	378	4070	11570	
	480	350	350	4	4	378	3750	10600	
	480	350	350	4	4	378	3750	10600	
	480	350	350	4	4	378	3800	10800	

Designations	Abutment and fillet dimensions				Weight	
	D _{1min}	b _{max}	k _{max}	Da		da
mm						
FCD6492240ZW/HG2YA3	417			404	340	141
FC6492280/YA34	408			442	336	157
FCD6492340/YA3	413	12	6	442	336	189
FCD6492340F3/YA3	413	12	6	442	336	187
FC6490240/YA34	412	12	6	432	336	120
FCD6492240ZW/HCC4YA3	417			444	334	141
FC6492240ZW/YA34	417			444	334	141
FCD6492240ZW/YA34/W281	417			444	334	141
FCD6496306/HG2YA3	427	12	6	462	336	197
FCD6496350F3/HG2YA34	427	16	8	462	336	230
FCD6496306/HCYA3	427	12	6	462	336	197
FCD6496350F3/HCYA34	427	12	6	462	336	230
FCD6692340	416.2	12	6	442	346	210
FC6692340-ZH	416.2	12	6	442	346	211
FCD6890250/C3YA4	406.2	12	6	432	356	115
FCD6890250/C9YA4-1	410.6	12	6	432	356	109
FCD6890250/C4YA34	410.6	12	6	432	356	109
FCD6890250/HCYA34	410.6	12	6	432	356	109
FC6890250/HG2	416			432	356	107
FC6890250/YAB	406.8	12	8	432	356	111
FC6890250/YAB-1	406.8	12	8	432	356	111
FC6890250/YAD	415	12	6	432	356	105
FC6890250/YAD-1	415	12	6	432	356	105
FC6890250/YAD-2	415	12	6	432	356	105
FC6890250/YA4-2	408	12	6	432	356	111.8
FCD6890250/YA34-1	410.6	12	6	432	356	109
FCD6890250F3/C4YA34	410.6	12	6	432	356	108
FCD6892260	418	12	6	432	356	125
FCD6896350	430.8	12	6	462	356	202
FCD6896350/YAB	419.6	12	6	462	356	212
FCDP6896350/HCYA4	432.4	12	6	462	356	203
FCD6896350F3/HC	430.8	12	6	462	356	200
FC6896350/YA34	430.8			462	356	202
FC6896350ZW/YA34	431			462	356	212

Four-row Cylindrical Roller Bearing

d 350~380 mm

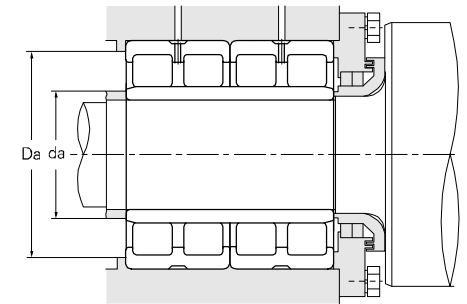
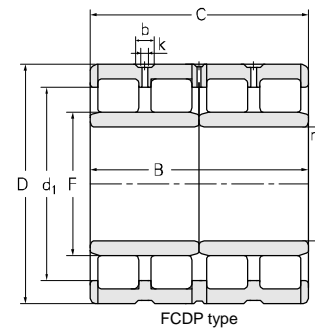
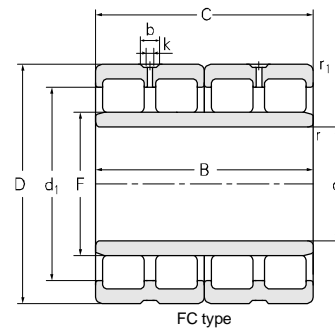
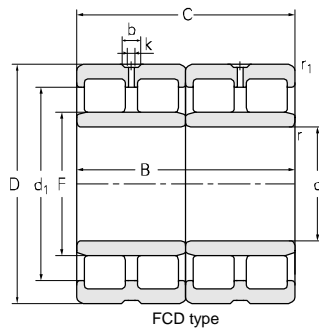

Principal dimensions							Basic load ratings		
d	D	B	C	r _{1min}	r _{min}	F	C _r	C _{or}	
mm									
kN									
350	500	380	380	6	3	388	4030	10200	
	500	380	380	3	6	388	3580	10600	
	500	410	410	3	11.5*20*	388	5800	13500	
	520	300	300	5	8*20*	401	4200	9000	
360	480	340	340	4	4	392	3700	11300	
	510	370	370	4	4	397	4950	11400	
	510	370	370	4	4	399.5	4950	11300	
	510	370	370	4	4	397	4220	11400	
	500	250	250	3	3	394	3600	7730	
	500	250	250	3	3	394	3300	8000	
	500	250	250	3	3	394	3600	7730	
	500	250	250	3	3	394	3600	7730	
	500	300	300	3	3	394	4100	11000	
	550	430	430	5	5	408	5000	13000	
	365	540	300	300	2	2	421	5000	11000
370	520	380	380	1.5	1.5	409	5230	12000	
	520	380	380	1.5	1.5	409	4300	12000	
	530	400	400	4	4	413	4650	12600	
	540	400	400	5	5	416	4490	13600	
375	520	360	360	5	15*20*	422	3500	12300	
	600	440	440	2	2	470	5350	15600	
380	500	315	315	4	4	412	3000	8700	
	520	290	290	4	4	426	2770	9100	
	520	290	290	4	4	426	2770	9100	
	540	260	260	4	4	428	3350	8550	
	540	300	300	2	8.5*20*	421	4650	10100	
	540	304	304	4	4	422	4650	10100	
	540	340	340	4	4	422	5250	11900	
	540	360	360	4	4	422	4850	12900	
	540	400	400	4	4	422	5050	14200	
	560	300	300	2	13.5*20*	424	4950	9650	
	560	325	325	5	5	425	4840	10000	

Designations	Abutment and fillet dimensions					Weight
	D _{1min}	b _{max}	k _{max}	Da	da	
mm						
kg						
FCDSP70100380/HC	440	12	6	478	364	225
FCDSP70100380	440	12	6	484	370	225
FCDP70100410	455	16.7	9	484	362	280
FC70104300	468			500	361	213
FCD7296340/HCYB2	441.5	12	6	462	376	172
FCD72102370	460	12	6	492	376	220
FCD72102370/YA4	462	12	6	492	376	241
FCD72102370F3	460	12	6	492	376	249
FC72100250ZW/HCYA3	456			484	374	156
FCD72100250F3/HC	456			484	374	124
FC72100250ZW/YA3	456			484	374	156
FC72100250ZW/HCYA3	456			484	374	156
FCD72100300/YA3	160	11	6	484	374	179
FCD72110430-KM	477.4	18	10	530	378	379
FC73108300	490	12	6	526	377	225
FCDP74104380	474	12	6	507	381	296
FCDP74104380/YAD	474	12	6	507	381	258
FCDP74106400/HCG2I	478	12	6	512	386	299
FCD74108400-KM	472	16	8	520	388	327
FCD75104360/HG2IYAD	470	12	6	500	388	241
FCDP75120440/P63	535	15	6	586	387	527
FCD76100300/YAG	460			482	396	157
FCD76104290F3/YA3/W281	467	12	6	502	396	192
FCD76104290F1/YA3/W281	467	12	6	502	396	192
FCD76108260	495			522	396	198
FCD76108300	490	12	6	526	395	220
FC76108304	488	12	6	522	396	227
FC76108340	488	12	6	522	396	256
FC76108360/HCC9	480	20	12	522	396	276
FCD76108400/YA3	488	12	6	522	396	297
FCD76112300	488	13.9	7.5	546	398	261
FCD76112325	506			540	398	263

Four-row Cylindrical Roller Bearing

d 390~440 mm

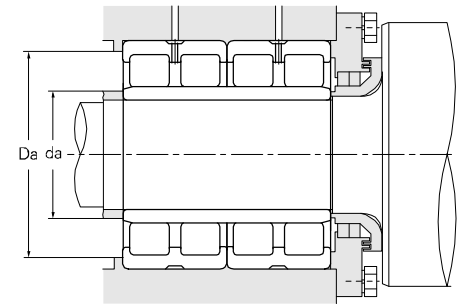
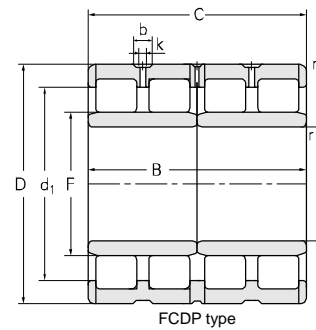
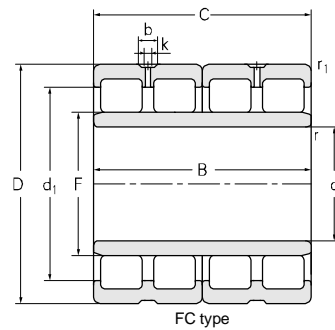
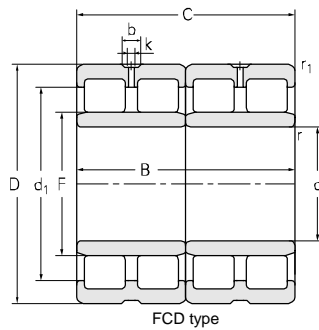

Principal dimensions							Basic load ratings		
d	D	B	C	r1min	rmin	F	Cr	Cor	
mm									
kN									
390	540	320	320	2	10*20*	431	5200	12000	
	550	400	400	4	4	432.3	4850	13400	
	550	400	400	5	1.5	434	4850	13400	
	550	400	400	4	4	432.3	4850	13400	
400	550	300	300	5	5	442	4460	5050	
	550	300	300	5	5	442	4640	5450	
	550	300	300	5	5	442	3450	9500	
	560	300	300	4	4	442	4550	10000	
	560	410	410	2	13.5*20*	445	6250	15600	
	560	410	410	5	5	445	4500	14000	
	560	410	410	5	12*20*	445	5200	15000	
	590	440	440	5	5	450	7250	16500	
	590	440	440	5	5	450	7100	15900	
	410	560	400	400	2	11*20*	450	6400	15800
560		400	400	2	11*20*	450	5600	14400	
600		440	440	5	5	460	6450	18300	
600		440	440	5	5	460	6450	18300	
600		440	440	5	5	460	6450	18300	
600		440	440	5	5	460	6500	16700	
600		440	440	5	5	460	6450	18300	
600		440	440	5	5	460	6450	18300	
420	580	260	260	4	4	468	4350	9600	
	580	320	320	4	4	463	4680	10800	
	600	440	440	5	5	470	5550	16300	
	600	440	440	5	5	470	5550	16300	
	600	440	440	5	5	470	7100	19500	
	600	440	440	5	10*20*	470	7100	19500	
	620	400	400	5	5	473	5800	15400	
	440	620	450	450	5	5	487	7420	15800
620		450	450	5	5	487	7420	15800	
620		450	450	5	12*20*	487	6700	21100	
620		450	450	5	5	487	6700	21100	
620		450	450	5	5	487	6700	21100	
620		450	450	5	5	487	6700	21100	
620		450	450	5	5	487	6700	21100	
620		450	450	5	5	487	6700	21100	
650		355	355	3	3	509.5	6250	14600	

Designations	Abutment and fillet dimensions					Weight
	D1min	bmax	kmax	Da	da	
mm						
kg						
FCD78108320	500	13.9	7.5	526	405	228
FC78110400K/HCYA4	496.5	12	6	532	406	330
FCD78110400/HG2YAD	498	20	10	530	401	300
FC78110400K/HG2YA4	496.5	12	6	532	406	330
FC80110300	502	12	6	530	418	223
FC80110300A	499.6	12	6	530	418	225
FC80110300S	502	12	6	530	418	223
FC80112300	513			542	416	242
FCD80112410	509	13.9	7.5	546	310	310
FCD80112410/HG2YA4	500	15	8	540	418	325
FCD80112410/HCYA34	509	13	7	540	418	320
FCD80114440	530			570	418	410
FCD80118440/HCYAD-SY	528	15	8	570	418	415
FCDP82112400	515	16.7	9	544	428	287
FCDP82112400/HCYAD	508	16.7	9	544	428	286
FCDP82120440/HCYA34	533	20	10	578	430	445
FCDP82120440-ZH	533	20	10	578	430	445
FCDP82120440/HCYA34	533	20	10	578	430	445
FCD82120440/HCYAD	533	20	10	578	430	425
FCDP82120440-ZH/W283	533	20	10	578	430	433
FCD84116260	536			560	438	205
FCD84116320	525			560	438	249
FCD84120440/HC	535	18	8	578	440	414
FCD84120440/HCP6YAB	535	18	8	578	440	414
FCDP84120440/HCYAD-1	540	29	15.9	578	440	417
FCDP84120440/HCYAD	540	29	15.9	578	445	417
FCD84124400/HC	550	15	8	598	440	423
FCDP88124450	563	15	8	598	460	452
FCDP88124450/YA6	563	15	8	598	460	452
FCDP88124450/HCYAD-KM	564.5	15	8	598	459	439
FCDP88124450/HC	563	15	8	598	460	436
FCDP88124450/HCYA36	563	15	8	598	460	436
FCDP88124450/HCEYA6	563	15	8	598	460	436
FC88130355	585			632	456	400

Four-row Cylindrical Roller Bearing

d 440~480 mm

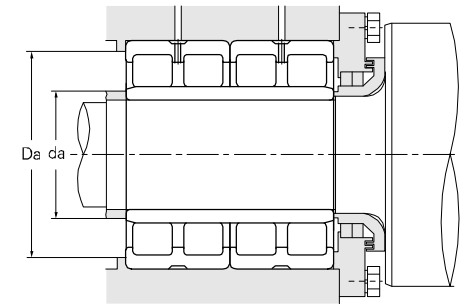
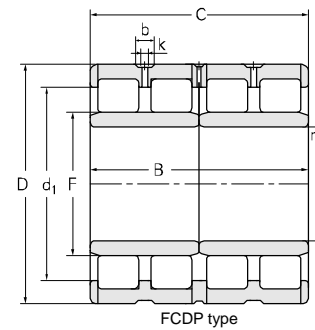
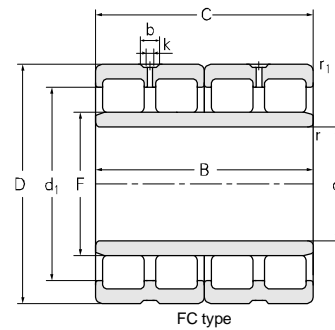
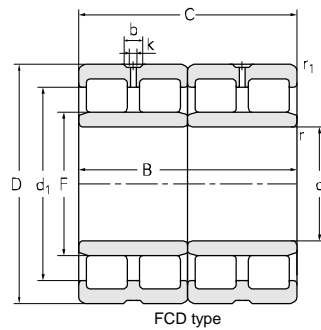

Principal dimensions							Basic load ratings		
d	D	B	C	r _{1min}	r _{min}	F	C _r	C _{or}	
mm									
440	650	355	355	4	12.5*20*	494	6700	14700	
	660	340	340	6	6	492	5100	13500	
447.295	635.176	463.55	463.55	5	13.5*20*	495	8400	20500	
450	590	300	300	4	14.5*45*	490	3900	12200	
455	700	310	310	6	6	640	5550	13900	
	700	310	310	6	6	640	5550	13900	
460	620	400	400	4	4	502	6150	15400	
	650	355	355	3	12*20*	509.5	6250	14500	
	650	424	424	3	12*20*	510	7800	18200	
	650	470	470	3	12*20*	509	8750	21500	
	650	470	470	3	12*20*	509	8750	21500	
	650	470	470	3	12*20*	509	8750	22400	
	680	400	400	6	6	518	8050	17400	
462	615.95	386	386	4	2	585	3470	8350	
475	600	368	368	3	3	504	5500	14700	
	600	392	392	3	3	504	5500	14700	
480	650	450	450	6	6	525	7840	15400	
	650	450	450	6	6	525	5350	1580	
	650	450	450	6	6	525	5350	1580	
	680	500	500	6	6	532	7980	23400	
	680	420	420	3	12*20*	528	8400	19400	
	680	500	500	6	6	532	7980	23400	
	680	500	500	6	6	532	7100	22900	
	680	500	500	6	6	532	7250	23400	
	680	500	500	6	6	532	7250	23400	
	700	420	420	6	12*20*	533	7800	20900	

Designations	Abutment and fillet dimensions					Weight
	D _{1min}	b _{max}	k _{max}	Da	da	
mm						
FC88130355A	584	11.1	6	630	459	421
FCD88132340ZW/HCC4YA3	582			636	462	425
FCDP89127463X4/HCYAD/W283	575	22	8	613	467	478
FC90114300	528	12	6	570	482	240
NNQP692KZW/P4YB5				686	470	422
NNQP692KZW/P5YB5				686	470	422
FCDP92124400/HCYAD	568	15	8	600	478	359
FCD92130355	584	11.1	6	632	479	375
FCD92130424	594	16.7	9	632	479	452
FCDP92130470	588	22	12	632	479	516
FCDP92130470/HCYAD/W283	588	22	12	632	479	488
FCD92130470	584	11.1	6	632	479	512
FC92136400	618	24	8	656	482	630
CCT6/462	570			596	476	338
FCDP95120368HC/YA3	563	16.7	9	582	491	237
FCDP95120392/YA3	577	16.7	9	582	491	242
FCD96130450	593	15	8	626	502	419
FCDP96130450/HCRG2/W283	593	15	8	626	502	430
FCDP96130450/HC	593	15	8	626	502	430
FCDP96136500/P54	632	15	9	656	502	599
FCD96136420	616	16.7	9	662	502	510
FCDP96136500/HCP64	632	15	9	656	502	599
FCD96136500/P64YA3	632	15	9	656	502	588
FCDP96136500/HCR	616	15	9	656	502	600
FCD96140420/HCYA3	625	18	8	676	502	554

Four-row Cylindrical Roller Bearing

d 500~530 mm

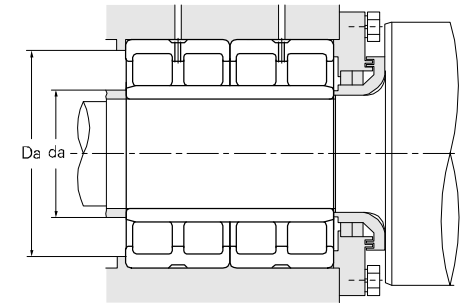
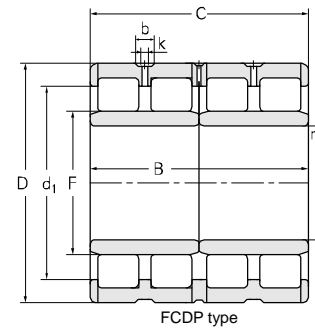
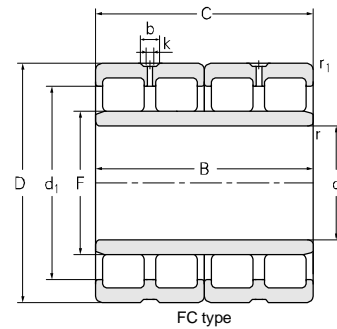
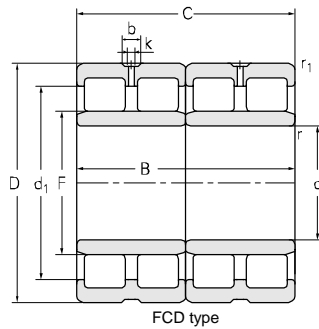

Principal dimensions							Basic load ratings		
d	D	B	C	r1min	rmin	F	Cr	Cor	
mm									
kN									
500	650	260	260	5	5	542	4000	10000	
	670	450	450	6	6	540	7840	20100	
	670	450	450	6	6	540	8640	23700	
	670	450	450	5	5	540	8580	22500	
	670	450	450	5	5	540	8400	22700	
	670	450	450	5	5	540	8400	22700	
	670	450	450	5	5	540	8400	22700	
	670	450	450	5	5	540	8000	21500	
	670	485	450	5	5	540	8400	22700	
	680	450	450	5	5	550	8200	22000	
	680	450	450	5	5	540	7600	22200	
	700	500	500	6	6	554	8600	21600	
	710	480	480	6	6	558	8100	23600	
	710	480	480	5	5	558	8780	21500	
	720	400	400	3	3	558	7850	17500	
	720	400	400	5	5	550	8500	18300	
	720	530	530	6	6	568	8550	28100	
	720	530	530	6	6	568	8550	28100	
	720	530	530	5	5	568	10500	28500	
	738	500	500	6	6	556	10500	23000	
510	680	500	500	5	7.5*20*	560	8950	26200	
	680	500	500	5	5	560	8300	25200	
	680	500	500	5	5	560	8300	25200	
	730	520	520	6	6	565	11000	27000	
	730	520	520	6	6	569	9480	21500	
	760	550	550	3	3	570	12000	26500	
	760	550	550	6	6	570	11200	29300	
	520	735	535	535	5	20*20*	574.5	11000	27800
530		760	520	520	5	12*20*	587	11500	28500
	760	520	520	5	12*20*	587	11100	27000	
	760	520	520	5	12*20*	587	11100	27000	
	780	570	570	3	3	601	12700	32500	
	780	570	570	6	6	595	13000	32000	
	780	570	570	6	6	601	11000	30000	
	780	570	570	6	6	601	11000	30000	
	780	570	570	6	6	595	13000	32000	

Designations	Abutment and fillet dimensions					Weight
	D1min	bmax	kmax	Da	da	
mm						
kg						
FCD100130260	600			628	520	220
FC100134450/P69	615	15	7	646	520	446
FCD100134450/P69HCYA3	617	15	8	646	520	460
FCDP100134450/HCC9YAD-1	614	18	10	648	520	451
FCDP100134450/HCYA4/W283	614	18	10	648	520	452
FCDP100134450/HCRG2YA4/W283	614	18	10	648	520	452
FCDP100134450/HCC9YAD-2	614	18	10	648	520	454
FCD100132450	612	16.7	9	648	520	455
FCDP100134450/HCEC9YAD	614	18	10	648	520	463
FCD100136450	622	13.9	7.5	664	520	485
FCDP100136450/HCYAD	623	18	10	658	520	488
FCDP100140500/HC	633.6	18	10	676	522	632
FCDP100142480/HCEC9YA4/W283	642	22	12	686	522	622
FCDP100142480/YA6	642	13.9	7.5	688	522	604
FC100144400	656	22.3	12	702	522	526
FCD100144400ZW/HCYA3	646			700	520	469
FCDP1001444530/HCRYA34	650	15	8	696	528	752
FCDP100144530/HCYAD-1/W283	650	15	5	696	528	752
FCD100144530/YA6	651	16.7	9	698	528	729
FCD100148500X1	671	22.3	12	714	522	732
FCDP102136500	627		12	654	534	525
FCDP102136500/HCRG2YAD	644	22	12	654	534	522
FCDP102136500/HCYAD/W283	628	22	12	654	534	521
FCDP102146520/HCYB2	660	18	8	702	536	722
FCD102146520	665			702	537	744
FCDP102152550	688	16.7	9	738	537	947
FCDP102152550/HCYAD-KM	685	22	10	732	537	898
FCDP104147535/HCYAD	664.5	22	12	709	548	757
FCDP106152520	683	16.7	9	734	552	773
FCDP106152520/HCYAD	684	22.3	12	734	552	788
FCDP106152520/HCRG2YAD	684	22.3	12	734	552	788
FCD106156570	697	22.3	12	758	556	954
FCDP106156570/HCRG2YAD	694	19	10	752	556	970
FCDP106156570/HCRG2YAD-1/W283	695	27.5	12	752	556	972
FCDP106156570/HCEYAD-1/W283	695	27.5	12	752	556	972
FCDP106156570/HCEYAD/W283	694	19	10	752	556	971

Four-row Cylindrical Roller Bearing

d 530~590 mm

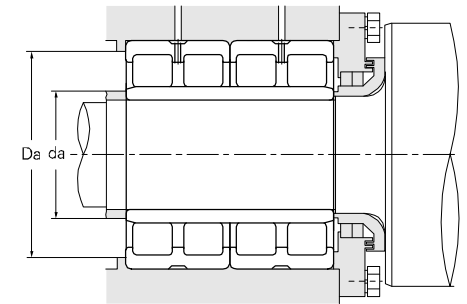
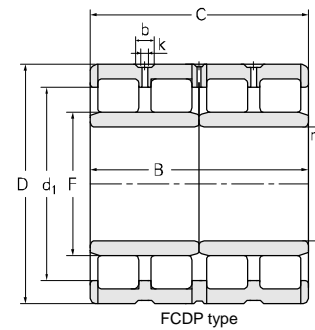
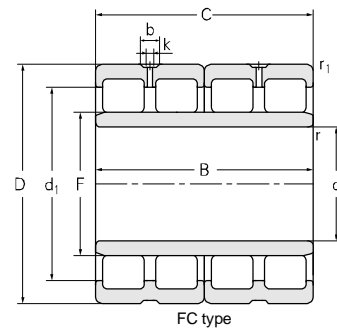
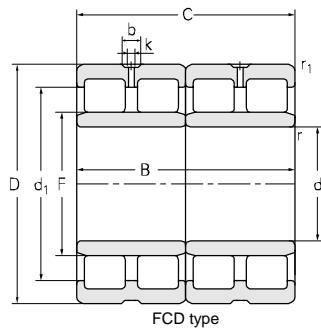

Principal dimensions							Basic load ratings		
d	D	B	C	r _{1min}	r _{min}	F	C _r	C _{or}	
mm									
kN									
530	780	500	500	6	6	591	9300	20500	
550	740	510	510	2	15*20*	600	10000	27500	
	800	520	520	6	10*20*	612	11500	26000	
	800	560	560	6	18.5*20*	610	12000	28000	
	800	520	520	6	6	612	10300	28500	
	800	520	520	6	6	612	12200	28500	
	800	520	520	6	6	612	12200	28500	
	800	560	560	6	18.5*20*	610	11900	32500	
	800	560	560	6	6	612	13100	31300	
	800	560	560	6	18.5*20*	610	13600	32500	
	800	560	560	6	18.5*20*	610	13600	32500	
	800	560	560	6	6	610	13600	32500	
	800	560	560	6	6	609	13500	32500	
560	800	600	600	7.5	7.5	620	13000	33500	
	820	315	279	3	6	625	13500	36000	
	820	600	600	3	20*20*	625	14200	34000	
	820	600	600	6	20*20*	625	12800	34000	
	820	630	630	3	3	625	14400	36000	
570	750	530	530	6	6	622	9000	26600	
	800	514	514	6	6	626	11000	29000	
	800	514	514	6	6	626	11000	29000	
	815	594	594	6	6	628	13000	35200	
580	780	520	486	2	12*20*	634	9900	27000	
	780	521	486	2	12*20*	634	9900	27000	
	780	558	486	2	12*20*	634	9900	27000	
	850	540	540	6	6	652	11500	33200	
	850	540	540	6	6	652	11500	33200	
590	820	590	590	6	6	649	12800	35100	

Designations	Abutment and fillet dimensions					Weight
	D _{1min}	b _{max}	k _{max}	Da	da	
mm						
kg						
FCD106156500	690			752	556	810
FCDP110148510/YA6	680	22.3	12	720	575	612
FCD110160520/YA6	721			772	576	890
FCD110160550/YA6	725			772	576	928
FCDP110160520	721			772	576	890
FCDP110160520/HC	721			772	576	890
FCDP110160520/HC/W283	721	18	10	772	576	893
FCDP110160560/HCYAD-2	725	24	12	772	576	958
FCDP110160560/HCG2I	721	18	10	772	576	957
FCDP110160560/HCRG2-YL	725	24	12	772	576	950
FCDP110160560/HCYAD-KM	725	24	12	772	576	950
FCDP110160560/HCYAD-1/W283	725	24	12	772	576	950
FCDP110160560/HCYAD/W283	724	24	12	772	576	956
FCDP112160600	722755	16.7	9	769	589	1010
FCDP112164630/HCC4YA3	743	18	10	798	586	1164
FCDP112164600	743	16.7	9	798	586	1075
FCDP112164600/HCYAD/W283	743	22	12	792	586	1091
FCDP112164630	743	16.7	9	798	580	1170
FC114150530/HCYA3	690			722	596	625
FCDP114160514/HCC9YAD	746	22	14	772	596	835
FCDP114160514/HCC9YAD-DNL	740	25	10	772	596	841
FCDP114163594	740	22	14	787	596	1010
FCDP116156486/WB	717			760	602	696
FCDP116156486/WB-1	717	16.7	9	760	602	700
FCDP116156486/WB-2	756	16.7	9	760	602	713
FCDP116170540/HCC9/W283	756	24	12	822	606	1082
FCDP116170540/HCC9	756	24	12	822	606	1082
FCDP118164590	748	16.7	9	792	616	990

Four-row Cylindrical Roller Bearing

d 600~660 mm

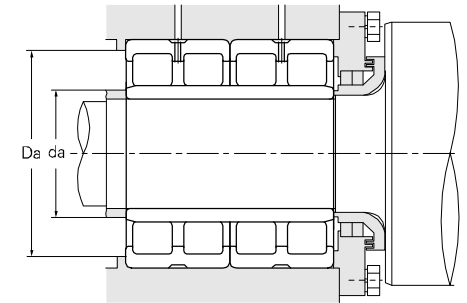
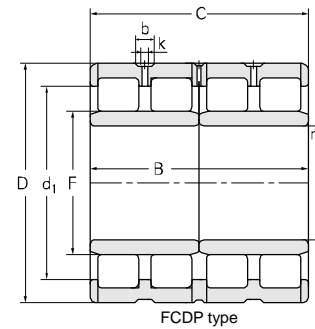
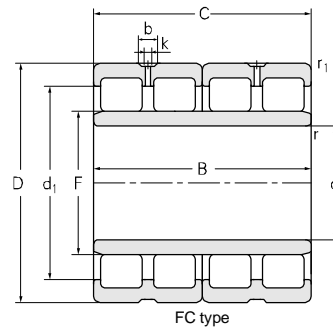
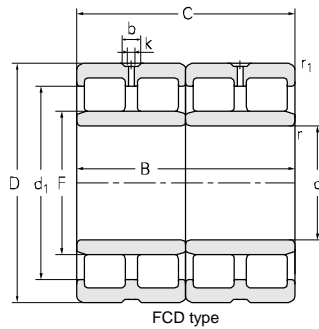

Principal dimensions							Basic load ratings		
d	D	B	C	r _{1min}	r _{min}	F	C _r	C _{or}	
mm									
600	820	575	575	3	6	660	12300	35000	
	820	575	575	3	6	660	9750	35000	
	820	575	575	3	17*20*	659	10900	35100	
	820	575	575	3	6	660	9750	35000	
	870	640	640	6	6	669	12000	38500	
	870	640	640	6	6	682	15500	41200	
	870	640	640	6	6	669	12000	38500	
	870	640	640	6	6	672	15700	41000	
	870	640	640	6	6	669	13200	38500	
	870	540	540	4	22*20*	672	13000	31500	
	870	540	540	6	6	672	12500	35700	
	870	540	540	6	6	672	12500	35700	
	610	870	660	660	6	12*20*	680	16900	44000
870		660	660	6	12*20*	680	16900	44000	
630	920	515	515	7.5	7.5	700	13700	17160	
	850	436	436	6	6	690	7450	23500	
	850	536	536	6	6	690	7800	23000	
	800	360	360	5	5	675	6850	19500	
640	880	600	600	6	6	700	13500	40000	
650	900	650	650	7.5	7.5	704	16900	43000	
	900	650	650	7.5	7.5	704	16900	43000	
	900	650	650	7.5	7.5	704	16900	43000	
	900	650	650	7.5	20*20*	704	14000	42000	
	920	670	670	4	17*20*	723	14300	44500	
	920	690	690	7.5	7.5	723	14500	45000	
	920	670	670	4	17*20*	723	17100	45000	
	920	670	670	7.5	17*20*	723	14300	44500	
	920	670	670	4	17*20*	723	14300	44500	
	920	670	670	7.5	7.5	723	14300	44500	
	920	670	670	4	17*20*	723	14300	44500	
	660	820	440	440	4	7.5	702	7450	22700

Designations	Abutment and fillet dimensions					Weight
	D _{1min}	b _{max}	k _{max}	Da	da	
mm						
FCDP120164575/HCYA6-1	768	18	9	798	626	945
FCDP120164575/HCRYA6/W283	750	18	9	798	626	947
FCDP120164575/HCYA4	750	18	10	798	626	951
FCDP120164575/HCYA6/W283	750	18	9	798	626	947
FCDP120174640/HCEYA34-AL	781	18	10	842	626	1313
FCDP120174640/HCYAD-1/W283	784	18	10	842	626	1324
FCDP120174640/HCYA34-FSBJ	781	18	10	842	626	1313
FCDP120174640/HCYAD/W283	784	18	10	842	626	1330
FCDP120174640/HCYA34	809	18	10	842	626	1347
FCDP120174540	780	16.7	9	846	626	1100
FCDP120174540/HCYAD	784	18	10	842	626	1120
FCDP120174540/HCYAD-FSDT	784	18	10	842	626	1120
FCDP122174660/HCYA34/W283-LG	790	20	12	842	633	1316
FCDP122174660/HCYA34	790	20	12	842	633	1316
FCD126184515/HC	825	25	12	889	659	1182
FCD126170436	770			822	656	720
NNU49/630/HCDT	780	24	10	822	656	778
FCD126160360	742			774	654	560
FCDP128176600	743	25	12	852	666	1120
FCDP130180650/HCYAD	821.4	30	12	869	679	1253
FCDP130180650/HCRG2YAD-1	821.4	30	12	869	679	1253
FCDP130180650/HCYAD-FSBJ	821.4	30	12	869	679	1257
FCDP130180650/HC	819.4	30	12	869	679	1275
FCDP130184670/HCYA3	829	18	10	896	679	1460
FCDP130184690	829	18	10	889	679	1490
FCDP130184670/HCYA34	829	18	10	896	681	1454
FCDP130184670/HCRG2YAD/W283-1	829	22	14	889	681	1456
FCDP130184670/HCRG2YAD/W283	829	18	12	896	681	1457
FCDP130184670/HCYAD-1	829	18	10	889	681	1457
FCDP130184670/HCYAD/W283	829	18	12	896	681	1454
FCD132164440	766			796	689	532

Four-row Cylindrical Roller Bearing

d 660~750 mm

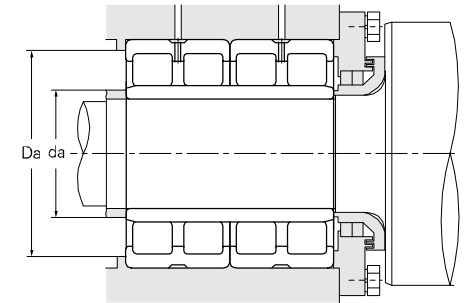
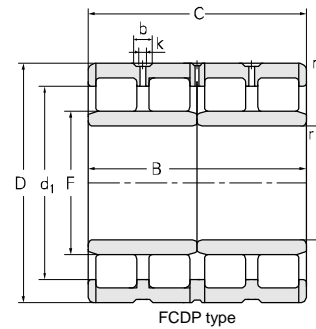
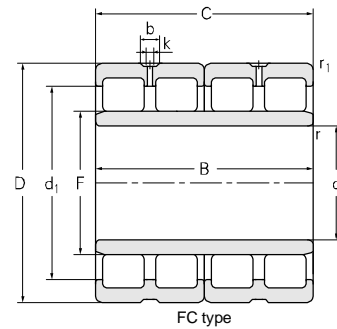
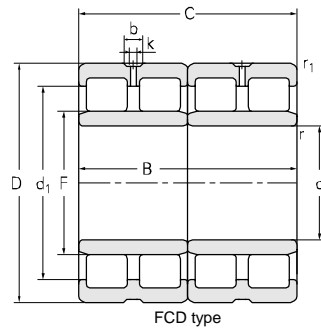

Principal dimensions							Basic load ratings	
d	D	B	C	r _{1min}	r _{min}	F	C _r	C _{or}
mm								kN
660	880	450	450	6	6	727	7500	23500
680	920	600	600	6	18*20*	743	12400	41600
	980	640	640	4	20*20*	760	17700	46000
	1020	680	680	6	6	775	20000	49500
690	980	715	715	20*20*	4	767.5	18800	51500
	980	750	750	7.5	11.4*20*	766	18800	51500
	980	750	750	7.5	7.5	766	20500	57500
	980	750	750	7.5	7.5	766	20500	57500
	980	750	750	7.5	20*20*	766	16100	51500
	980	715	715	20*20*	4	767.5	18800	51500
700	930	620	620	3	18*20*	763	15000	42800
	930	620	620	3	18*20*	763	15100	44000
	980	700	700	6	6	774	17500	48500
	1000	710	710	4	4	770	19000	47500
710	1000	715	715	7.5	17*20*	787.5	20100	55500
	1000	715	715	7.5	7.5	787.5	16700	54200
	1000	715	715	7.5	17*20*	787.5	20100	55500
	1000	715	715	7.5	7.5	787.5	16700	54200
	1020	710	710	4	4	785	19500	49700
725	1000	700	700	6	6	796	18000	49500
730	960	620	620	3	20*20*	790	15400	45000
	1000	700	700	4	20*20*	802	16600	54500
	1030	750	750	6	21*20*	809	20500	58500
	1030	750	750	6	21*20*	809	21000	58000
	1030	750	750	6	21*20*	809	21000	58000
	1030	750	750	6	21*20*	809	21000	58000
750	1000	670	670	3	20*20*	813	17000	48500
	1000	670	670	3	20*20*	813	17000	48500
	1000	670	670	3	20*20*	813	18000	52000

Designations	Abutment and fillet dimensions				Weight	
	D _{1min}	b _{max}	k _{max}	Da		da
	mm					
FCD132176450	806			852	686	782
FCDP136184600/HCC2IYAD	839	22	12	892	708	1178
FCDP136196640/HCC4YAD/W283	875	22	12	956	710	1652
FCDP136204680	929	22	12	992	710	2050
FCDP138196715/HCP69YAD	907.5	22	12	949	712	1805
FCDP138196750/HCC9YA6	880	45	13	949	719	1920
FCDP138196750/HCYAD/W283-2-LG	880	27	15	949	719	1898
FCDP138196750/HCYAD/W283-2	880	28	15	949	719	1898
FCDP138196750/HCYAD/W283	880	45	15.9	949	719	1876
FCDP138196715/HCP69YAD-1	907.5	22	12	949	712	1805
FCDP140186620	859	22.3	12	908	727	1170
FCDP140186620/HCEC9YAD/W283	854	22.3	12	908	727	1201
FCDP140196700	900	22.3	12	952	726	1680
FCDP140200710	916	22.3	12	976	722	1820
FCDP142200715/HCYAD	902	22.3	12	969	739	1844
FCDP142200715/HCRG2YA4	902	22.3	12	969	739	1848
FCDP142200715/HCYAD/W283	902	22.3	12	969	739	1844
FCDP142200715/HCYA4/W283	902	22.3	12	969	739	1844
FCDP142204710	932	22.3	12	996	732	1940
FCDP145200700	920	22.3	12	972	751	1750
FCDP146192620	886	22.3	12	938	758	1218
FCDP146200700/HCEYAD/W283	916	45	15.9	976	758	1681
FCDP146206750	929	22.3	12	1002	760	2035
FCDP146206750/HCEYAD/W283-LG	924.2	22	12	1002	760	2076
FCDP146206750/HCRG2YAD	924.2	22	12	1002	760	2076
FCDP146206750/HCFY/W283	924.2	22	12	1002	760	2081
FCDP150200670/HCC9	921	22.3	12	978	779	1522
FCDP150200670/HCC91	921	22.3	12	978	779	1522
FCDP150200670/HCYAD/W283	919	22.3	12	978	779	1497

Four-row Cylindrical Roller Bearing

d 750~840 mm

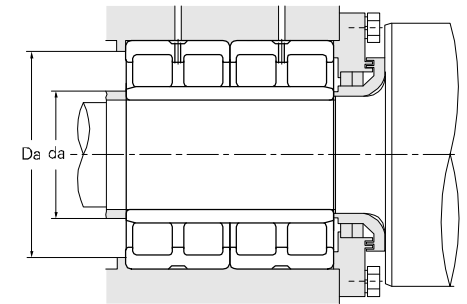
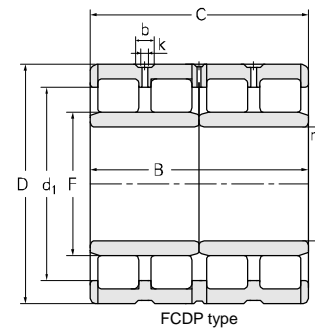
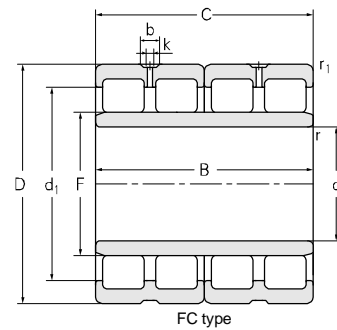
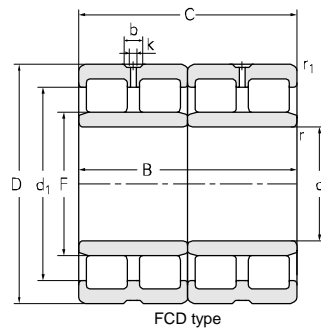

Principal dimensions							Basic load ratings		
d	D	B	C	r _{1min}	r _{min}	F	C _r	C _{or}	
mm									
750	1080	665	650	7.5	7.5	833	19500	48000	
	1090	750	750	7.5	22*20*	832	21500	51500	
	1133	670	670	6	6	848	21000	50500	
760	1015	700	700	7.5	7.5	832	18500	55000	
	1030	750	750	7.5	7.5	828	21000	61200	
	1079.5	787	787	7.5	7.5	846	26600	64000	
	1079.6	787.4	787.4	5	22*20*	846	26600	64000	
	1080	805	790	6	6	846	23500	65000	
	1080	790	790	7.5	7.5	846	23500	65000	
761.425	1079.6	787.4	787.4	5	22*20*	846	26600	64000	
780	1070	780	780	6	25*20*	853	22000	60000	
	1070	780	780	7.5	7.5	853	21000	63000	
	1070	780	780	7.5	7.5	849	21400	65700	
790	1015.9	610	610	6	6	850	17500	50000	
800	1080	700	700	3	3	878	18800	48500	
	1080	700	700	5	5	878	19030	59500	
	1080	700	700	5	5	878	17300	59500	
	1080	750	750	6	6	880	20000	60000	
820	1130	800	800	4	23*20*	903	19700	67000	
	1130	800	800	4	23*20*	903	19700	67000	
	1130	800	800	4	23*20*	903	19700	67000	
	1130	800	800	4	23*20*	903	19700	67000	
	1130	800	800	4	23*20*	903	19700	67000	
	1130	800	800	4	23*20*	903	19700	67000	
	1130	800	800	4	23*20*	903	19700	67000	
	1130	800	800	4	23*20*	903	19700	67000	
	1130	800	800	4	23*20*	903	19700	67000	
	1130	800	800	4	23*20*	903	19700	67000	
	1160	840	840	7.5	7.5	910	21600	68500	
830	1080	710	710	7.5	25*20*	896	14500	60500	
840	1160	840	840	7.5	7.5	920	24700	70800	

Designations	Abutment and fillet dimensions					Weight kg
	D _{1min}	b _{max}	k _{max}	Da	da	
mm						
FCDP150216650/WB	989	22.3	12	1049	779	2020
FCDP150218750	993	22.3	12	1059	780	2410
FCDP150226670X1	1023	22.3	12	1105	780	2450
FCDP152203700	973	22.3	12	984	789	1600
FCDP152206750	988	22.3	12	999	789	1870
FCDP152215787X4/HC-1	982	23.5	12	1048	789	2373
FCDP152215787X4/HC	982	23.5	12	1054	789	2373
FCDP152216790X1	974	22.3	12	1052	789	2450
FCDP152216790	974	22.3	12	1049	789	2420
FCDP152215787X4/HC/W283	982	23.5	12	1054	789	2365
FCDP156214780	988	22.3	12	1042	809	2280
FCDP156214780/HCYAD-1/W283	971	23.5	12	1039	809	2177
FCDP156214780/HCYAD	967	23.5	12	1039	809	2164
FCDP158203610X1	960	22.3	12	988	816	1280
FCDP160216700/HC	982	23.5	12	1058	820	1850
FCDP160216700/HCP6YAD	1018	30	12	1054	824	1918
FCDP160216700/HCC4YAD/W283	990	30	12	1054	824	1930
FCDP160216750	1020	23.5	12	1052	826	2030
FCDP164226800/HC	1026	23.5	12	1106	856	2534
FCDP164226800/HCYA3	1026	23.5	12	1106	856	2534
FCDP164226800/HCP6YA3-SY	1026	23.5	12	1106	856	2534
FCDP164226800/HC2IYA3	1026	23.5	12	1106	856	2511
FCDP164226800/HCYA3-SY/W283	1026	23.5	12	1106	856	2521
FCDP164226800/HCYA34/W283	1026	23.5	12	1106	856	2521
FCDP164226800/HCYA3/W283	1026	23.5	12	1106	856	2521
FCDP164232840	1045	23.5	12	1129	855	2750
FCDP166216710/HCC9YA3	995	23.5	12	1049	858	1838
FCDP168232840	1016	22.3	12	1129	875	2730

Four-row Cylindrical Roller Bearing

d 850~950 mm

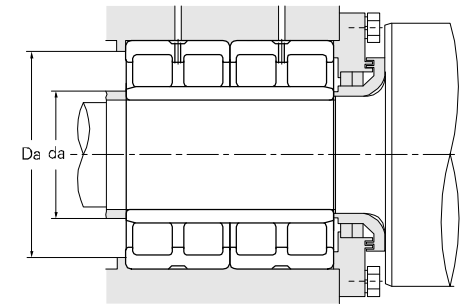
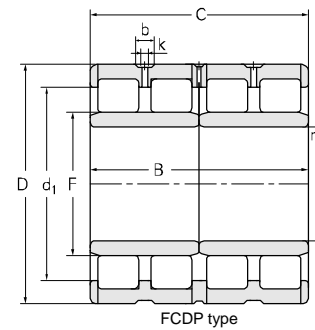
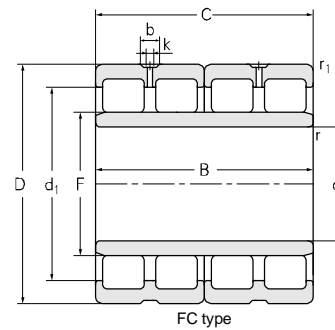
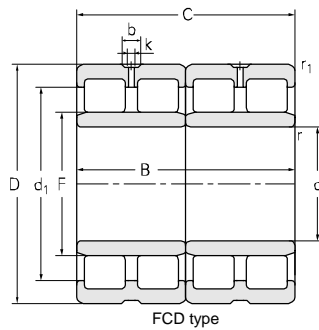

Principal dimensions				Basic load ratings				
d	D	B	C	r _{1min}	r _{min}	F	C _r	C _{or}
mm								
kN								
850	1150	840	840	4	23*20*	928	25400	76500
	1150	840	840	6	23*20*	928	24000	75000
	1150	840	840	6	23*20*	928	25000	75500
	1150	840	840	6	23*20*	928	24000	75000
	1180	650	650	7.5	7.5	945	19000	50500
	1180	850	850	4	20*20*	940	26100	74000
	1180	875	850	7.5	7.5	940	26100	74000
860	1140	750	750	7.5	7.5	938	20500	61000
	1160	735	710	6	6	940	21000	60000
880	1140	80	800	6	6	946	24000	76000
900	1220	840	840	4	24*20*	989	26300	80000
	1220	840	840	4	24*20*	989	20000	80000
	1220	840	840	4	24*20*	989	25300	83500
	1230	895	870	7.5	7.5	990	26400	80000
	1280	780	780	7.5	23*20*	998	28500	80500
	1280	930	930	4	25*20*	1000	32500	93500
	1280	1050	840	7.5	7.5	1000	28900	80500
920	1280	815	800	7.5	7.5	1010	28700	80000
	1280	865	850	7.5	7.5	1015	27600	77500
	1300	975	950	7.5	7.5	1019	32500	92500
949.85	1300	850	850	7.5	25*20*	1044	27300	90500
950	1300	850	850	7.5	7.5	1044	32200	85000
	1300	850	850	10	10	1044	28600	80500
	1300	850	850	10	10	1044	21500	64000
	1300	850	850	7.5	7.5	1044	33300	90500
	1300	850	850	7.5	7.5	1044	23000	85000
	1360	975	975	6	26*20*	1075	34000	100000
	1360	1000	1000	5	22*20*	1075	37500	105000
	1360	1000	1000	5	5	1075	37500	105000
	1360	1000	1000	5	22*20*	1075	41500	113000

Designations	Abutment and fillet dimensions				Weight	
	D _{1min}	b _{max}	k _{max}	Da		da
mm						
kg						
FCDP170230840/HC	1056	22.3	12	1126	882	2560
FCDP170230840/HCRG2YAD/W283	1056	23.5	12	1122	882	2550
FCDP170230840/HCE/W283	1055	23.5	12	1122	882	2598
FCDP170230840/HCYAD/W283	1056	23.5	12	1122	882	2545
FCDP170236650	1088	22.3	12	1149	885	2100
FCDP170236850/HC	1084	22.3	12	1156	885	2920
FCDP170236850/WB	1084	22.3	12	1149	885	2950
FCDP172228750	1060	22.3	12	1109	895	2100
FCDP172232710/WB	1070	22.3	12	1132	895	2150
FCDP176228800	1040	22.3	12	1112	906	2210
FCDP180244840/HC	1117	22.3	12	1196	929	3050
FCDP180244840/HCYAD/W283	1113	22.3	12	1196	929	2970
FCDP180244840/HCE/W283	1116	22.3	12	1176	929	2958
FCDP180246870/WB	1123	22.3	12	1199	929	3150
FCDP180256780	1175	22.3	12	1249	929	3250
FCDP180256930/HC	1152	22.3	12	1256	929	4050
FCDP180256840/WB	1152	22.3	12	1249	929	3890
FCDP184256800/WB	1238	22.3	12	1249	949	3280
FCDP184256850/WB	1238	22.3	12	1249	949	3450
FCDP184268950/WB	1256	22.3	12	1269	949	4180
FCDP190260850E/HCC9YA3-JG	1196	30	14	1269	982	3537
FCDP190260850/C9HCYA3	1182	30	14	1269	979	3390
FCDP190260850/HCC9	1182	30	16	1264	984	3390
FCDP190260850/HCP69YAD	1186.8	32	12	1264	984	3360
FCDP190260850E/HCC9YA3	1234	30	14	1269	979	3550
FCDP190260850/HCC9YA3	1182	30	14	1269	979	3443
FCDP190272975	1227	22.3	12	1332	982	4895
FCDP1902721000	1229	22.3	12	1334	982	5013
FCDP1902721000/K30	1229	22.3	12	1334	982	4820
FCDP1902721000/HCEYAD/W281	1233	30	18	1334	982	5027

Four-row Cylindrical Roller Bearing

d 970~1480 mm

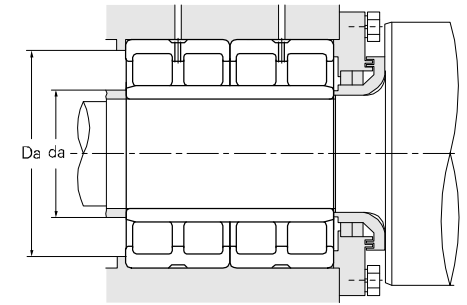
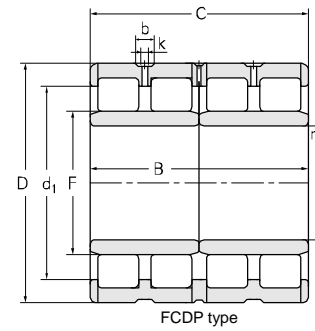
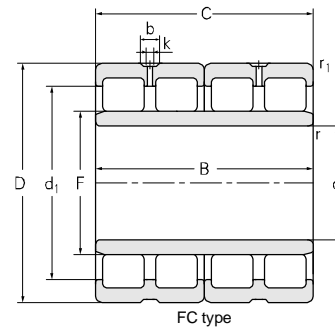
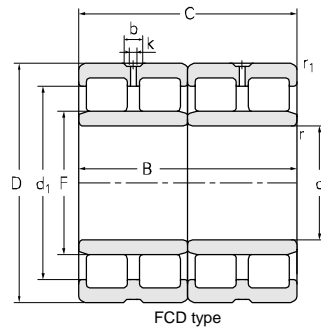

Principal dimensions				Basic load ratings				
d	D	B	C	r _{1min}	r _{min}	F	C _r	C _{or}
mm								kN
970	1145	705	685	6	6	940	20500	63000
980	1310	880	880	14*45*	20*20*	1061.7	28500	86500
1000	1360	800	800	4	23*20*	1101	27000	82800
1030	1380	850	850	7.5	7.5	1124	29000	90500
1040	1440	1000	1000	7.5	27*20*	1133	37900	93500
1200	1590	1050	1050	6	30*20*	1305	41800	13500
1270	1602	850	850	7.5	7.5	1354	42000	13600
1300	1655	890	880	7.5	7.5	1391	37300	122000
1350	1765	1360	1360	7.5	42*20*	1457	40000	122000
1400	1780 1900	1200 1360	1200 1360	9.5 12	40*20* 40*20*	1493 1521	52300 61500	163000 182000
1480	1849.74	1100	1100	7.5	7.5	1574	52500	164000

Designations	Abutment and fillet dimensions				Weight	
	D _{1min}	b _{max}	k _{max}	Da		da
mm						
FCDP174229685/WB	1044	22.3	12	1117	996	1990
FCDP196262880	1198	30	16	1266	1010	3300
FCDP200272800	1237	22.3	12	1336	1036	3560
FCDP206276850	1258	22.3	12	1349	1065	3650
FCDP2082881000	1335	22.3	12	1409	1080	5090
FCDP2403181050	1465	24	15	1562	1242	5980
FCDP254320850X1	1568	22.3	12	1571	1305	6000
FCDP260331880HC/WB	1552	22.3	12	1624	1335	4800
FCDP2703531360	1620	22.3	12	1734	1400	9110
FCDP2703561200	1671		12	1745	1450	7380
FCDP2703801360	1670	22.3	12	1860	1450	11300
FCDP296370110X1	1700	22.3	12	1818	1515	7450

d 51-180 mm

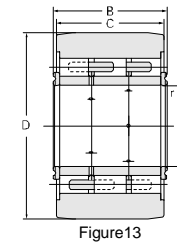
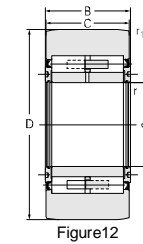
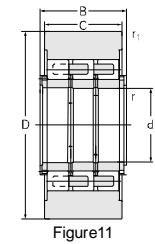
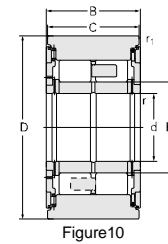
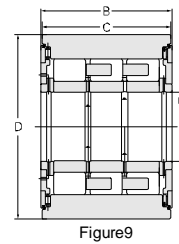
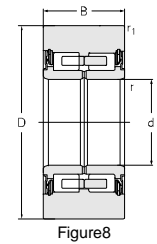
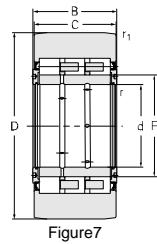
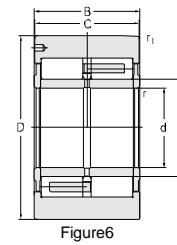
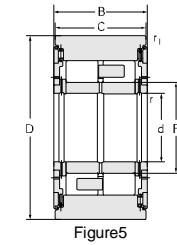
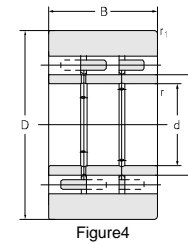
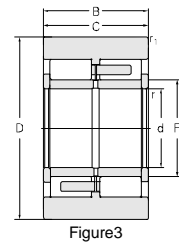
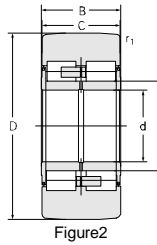
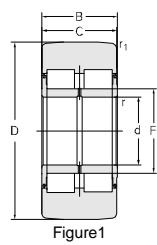

Designations	Principal dimensions						
	d	D	B	C	r _{1min}	r _{min}	F
	mm						
BNPF102060X1-2RZ	51	98.4	60	54	2	0.5*45*	61.14
BNPF112564X1-2RZ	55	126	64	63.2	2	0.5*45*	69
BNPF123075-2RZ	60	150	75	73	1	0.8	75
BNPF123075-2RZ-1	60	150	75	73	1	1.2	75
SJ-NNFP130	130	300	172.64	172.64	4	2	158.45
SJ-TCNB130	130	300	172.64		4	2.5	158.455
SJ-TCNB130/WN26	130	300	172.64		4	2.5	158.455
SJ-TCNB130-2	130	300	172.64		4	2.5	159.455
SJ-TCNB130-1	130	300	172.664		2.5	2.5	158.7
SJ-TCNB130-3	130	300	172.644		2.5	2.5	161
SJ-NNUP130	130	300.02	132	129	3.1	2	156
SJ-NNUP130-2ZL	130	300.02	172.65	171.6	2.5	2.5	156
SJ-NNUP130-2ZL-1	130	300.02	172.65	171.6	3.1	2	156
SJ-TCNP130-XRS	130	300.2	170	168	2.5	1.1	158.455
SJ-NNJ180-2RS	180	406.42	171.04		1.5	10*15*	217
SJ-TCNB180	180	406.42	171.04		1.5	4	217.3
SJ-TCNB180-1	180	406.42	171.04		1.5	4	217.3
SJ-TCNB180-PX	180	406.42	171.04		1.5	4	217.3

Basic load ratings		Weight	Graph
C _r	C _{or}		
kN		kg	
154	270	4.53	Figure1
172	260	4.53	Figure2
270	390	7.85	Figure2
270	390	7.85	Figure2
1390	2500	69.6	Figure3
1720	2670	72.3	Figure4
1720	2670	72.2	Figure4
1880	2940	73.6	Figure4
1510	2790	72.9	Figure4
1480	2810	72	Figure4
1090	1820	53.8	Figure6
1450	2430	70.1	Figure2
1450	2430	69.8	Figure2
1300	2230	68.5	Figure7
1450	2770	125	Figure8
2360	4050	130	Figure4
2360	4050	130	Figure4
2360	4050	130	Figure4

d 180~215 mm

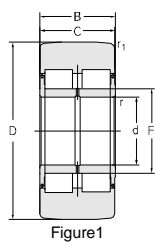

Figure1

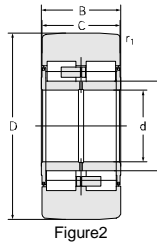

Figure2

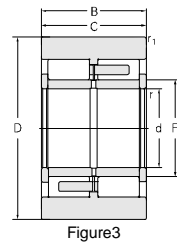

Figure3

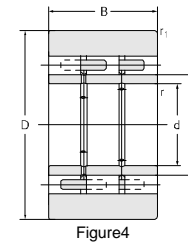

Figure4

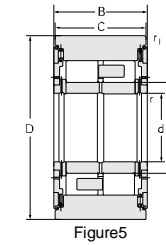

Figure5

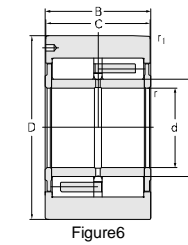

Figure6

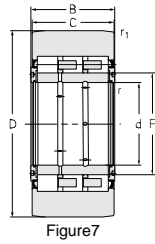

Figure7

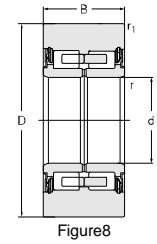

Figure8

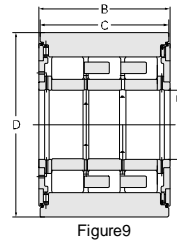

Figure9

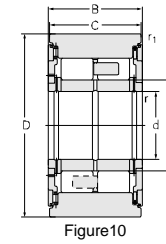

Figure10

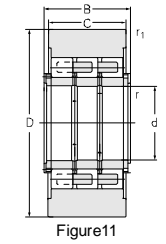

Figure11

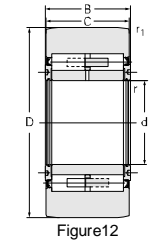

Figure12

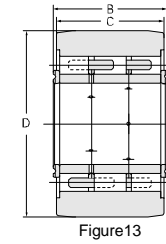

Figure13

Designations	Principal dimensions						
	d	D	B	C	r _{1min}	r _{min}	F
	mm						
SJ-TCNP180-XRS	180	406.42	182	179	2.5	1.1	222
SJ-TCNP180-XRS-2	180	406.42	171	169	2.5	1.1	222
SJ-TCNP180-XRS-3	180	406.42	224	222	2.5	1.1	222
SJ-TCNB180X2	180	406.42	224		1.5	4	217.3
SJ-TCNP180-XRS-1	180	406.6	181	179	2.5	1.1	222
SJ-TCNP180-2	180	410	240	220	1.1	1.1	
BNPF3697212	180	485	211.7	205.7	1.1	1.1	239
BNPF3697344	180	485	344	338	1.1	1.1	
BNPF3697344A	180	485	344	338	1.1	1.1	238
BNPF3897212X2	190	485	217.7	211.7	1.1	1.1	238
BNPF3897218X2A	190	485	217.5	211.1	1.1	1.1	239
BNPF3897350X2	190	485	349.7	343.7	1.1	1.1	238
BNPF3897350X2A	190	485	349.5	343.5	1.1	1.1	
BNPF41104240	205	520	240	216	1.1	1*45*	
BNPF41104240/C9	205	520	240	216	1.1	1*45*	
SJ-NNUP215-XRS	215	550	205	200	1.1	1.1	

Basic load ratings		Weight	Graph
C _r	C _{or}		
kN		kg	
1740	3200	133	Figure7
1700	3100	124	Figure7
2200	4300	166	Figure7
2640	5250	171	Figure4
1800	3300	133	Figure7
2500	4950	170	Figure13
2740	3680	230	Figure5
4550	7050	380	Figure9
4700	7000	385	Figure5
2950	3850	230	Figure10
2740	3680	230	Figure5
4700	7000	379	Figure10
4550	7050	378	Figure9
3500	5350	277	Figure11
3500	5350	277	Figure11
2600	4500	293	Figure12

Track Roller Bearing

d 50-110 mm

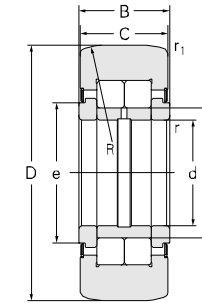
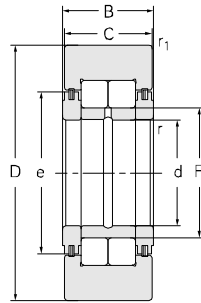

Designations	Principal dimensions					
	d	D	B	C	r _{1min}	r _{min}
	mm					
NNTR50-2ZL	50	130	65	63	1.5	2*45*
NUTR56160	56	160	63	60	5	1.5
NUTR56160/YA7	56	160	63	60	5	3
NUTR60130	60	130	65	62	5	1.5
NNTR60-2ZL	60	150	75	73	3	2*45*
NUTR60165X	60	165	65	60	1.1	1.5
NUTR65150	65	150	54	52	2	2
NNTR65-2ZL	65	160	75	73	3	2
NNTR70-2ZL	70	180	85	83	3	2*45*
NUTR70	70	190	60	58	2	1.5
NUTR80170	80	170	62.5	58	3	3
NUPTR80R-2ZL	80	190	62	60	2*45*	1.5
NUTR616-2RS/C9	80	190	80	80	1.5	1.5
NNTR80-2ZL	80	200	90	88	4	2
NNTR80DZ	80	200	90	88	3	1.5*45*
NUTR616-2RS/C9YAD	80	215	100	100	1.5	1.5
NNTR90-2Z	90	220	100	98	1	2
NNTR90-2ZL	90	220	100	98	4	2.5
NNTR100R-2ZL/YA2	100	230	93	90	4	2
NNUPTR100R-2ZL1	100	230	93	90	6	3
NNTR100	100	240	105	103	3	1.5*45*
NNTR100DZ	100	240	105	103	3	1.5*45*
NNTR100-2Z	100	300	55	55	0.5	1.5
NNTR100WB-2Z	100	300	65	65	0.5	1.5
NNTR100-1/C9	100	300	82	80	1.5	1*45*
NNTRP105R-2ZL/S2YA2	105	280	135	135	2	2
NUTR110 200	110	200	60	58	4	1.5*45*

Basic load ratings		Limit speed ratings	installation size		Weight
C _r	C _{or}	Grease	e	F	
kN		r/min	mm		kg
245	320	1200	63	60	5.09
275	380	1000	82	72.3	7.87
295	420	1000	101	77	7.69
230	385	950	78	74.2	4.74
250	410	880	83	76	7.86
240	390	850	92.2	75.5	8.41
235	375	850	94	85.7	5.26
280	460	800	82	78.5	8.44
410	610	740	92	86	12.9
234	345	700	87	85.7	10.3
350	510	630	125.2	98	7.55
285	425	600	115	97	7.7
240	390	600	105	96	13.2
530	835	580	111	102.3	16.5
470	770	580	101	94.2	16.7
240	390	550	105	96	18
545	880	420	119	108.5	22
630	1000	420	119	112.5	22.2
560	950	380	126	116	16.7
490	900	380	132	122.5	16.4
680	1210	380	131	122	27.6
680	1210	380	131	122	27.6
230	480	350	116	110	3.37
230	480	350	110.15	110	3.42
710	1220	350	152	134	36.7
1040	1800	320	152.4	142	44.2
500	760	300	160.9	126	8.93

Track Roller Bearing

d 110~150 mm

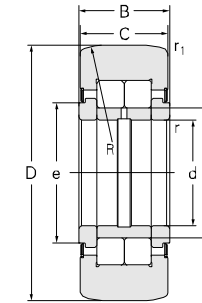
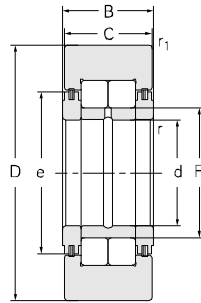

Designations	Principal dimensions					
	d	D	B	C	r _{1min}	r _{min}
	mm					
NNTR110X3-2ZL	110	240	190	180	4	3
NNTR110	110	250	100	100	3	1.1*45*
NNTR110-2ZL	110	260	115	113	4	2
NNTR120-2Z	120	290	135	133	3	2
NUTR130230XS	130	230	120	120	4	3
NUTR130230XS/YAD	130	230	120	120	4	3
NNTR130-2ZL	130	250	106	103	4	4
NNTR130-XRS	130	275	110	110	2	7
NNTR130-2ZL-1	130	310	146	144	5	3
NNTR140-2ZL	140	250	114	114	5	4
NUTR140250XS	140	250	115	115	20*23*	4
NNTR150-2ZL	150	360	173	171	5	3.75*45*

Basic load ratings		Limit speed ratings	installation size		Weight
C _r	C _{or}	Grease	e	F	
kN		r/min	mm		kg
1260	2720	260	142	134	49.1
380	695	250	132	124	27.3
775	1350	240	143	133	35.6
880	1600	260	157	143	50.9
880	1550	230	186.5	130	23.6
1050	1610	230	173	146	23.5
800	1330	240	160	147	26.8
660	1180	250	170	154	29.4
1150	1930	260	165	153	65
610	1300	220	179	158	27.7
755	1570	220	160	160	27.1
1570	3040	200	196	191	105

Split Bearing



d 200~750 mm

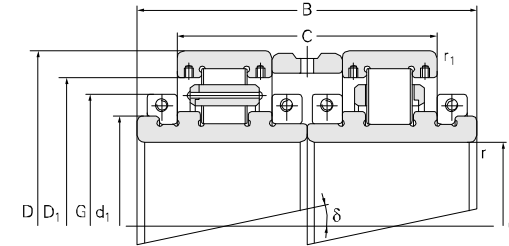
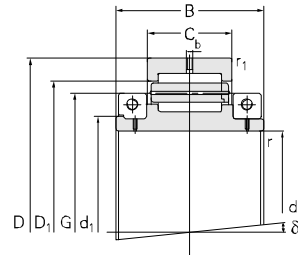
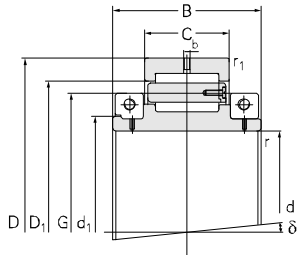

Designations	Principal dimensions					
	d	D	B	C	r _{1min}	r _{min}
	mm					
N640D	200	368.3	156.369	90.488	4	4
N640D-1	200	368.3	156.369	90.488	4	4
N680D	400	685.8	292	166.7	3	8
ND69/500X2D/DR-SY	500	670	450	360	5	5
ND6/620D/DR	620	820	380	290	5	12
ND6/630D/DR	630	794	380	278	5	10
ND6/650D/DR	650	820	380	290	5	17
ND6/700/HCRYA8	700	870	380	290	12	12
N6/711.2D	711.2	892.2	184.15	87.3	5	7.5
N6/711.2DF3	711.2	892.2	184.15	87.3	5	7.5
N6/750D	750	920	185	106	7.5	7.5
N6/750DF3	750	920	185	106	7.5	7.5
ND6/750DF3/HCR	750	960	380	290	5	15
ND6/750DF3/HCR	750	960	380	290	5	15

Basic load ratings		D1	d1	G	b	δ	Weight
C _r	C _{or}						
kN		mm		angle		kg	
1060	1600	312	244	290	8.5	6*	63
1060	1600		244	290	8.5	6	61.4
3340	6250	596	458	548	12	6*	378
3300	8700	613	543	610		6*	402
3400	9100	752	671	740		6*	505
3500	9400	740	676	736	10	6*	407
3250	9100	762	700	758		6*	455
3500	10200	749	811	821	10	6*	494
1790	5600	823	767.5	820	8	6*	225
1790	5600	823	767.5	820	8	6	225
2400	6250	864	802	863	8	6*	241
2400	6250	864	802	863	8	6	241
3940	10800	887	806	870		6*	626
3940	10800	887	806	870		6	626

Spherical Roller Bearing

Product Characteristics:

Two rows spherical rollers are put between the spherical raceways on the outer ring and the two grooves on the inner ring for spherical roller bearings. Since the curve center of outer ring is the same as that of the whole bearing arrangement, these bearings are self-aligned and automatically adjust the bending of the shaft and housing, besides, it can also compensate the concentricity error caused by this. Except radial load, these bearings can also carry combination of axial and radial load in two directions and possess high load capacity as well as good resistance to vibration and impact.

Spherical roller bearings are mainly applied to metallurgical machinery, mining machinery, papermaking, vessel, textile machinery, coal mill, electric power and other kinds of mechanical equipments. They are the bearings that are mostly widely used in mechanical industry.

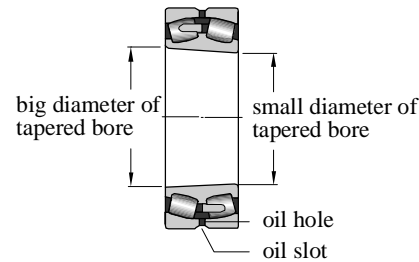
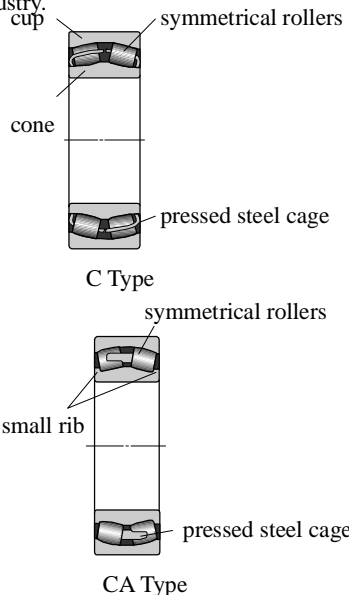

Product types

ZWZ spherical roller bearings can be divided into the following types:

- .Open type spherical roller bearing
- .Sealed spherical roller bearing
- .Spherical roller bearings used in vibration riddles
- .SDB type spherical roller bearing
- .Split spherical roller bearings

Open type spherical roller bearing contains asymmetrical roller bearing and symmetrical roller bearing. The main difference is the design of inner ring and cage.

Asymmetrical roller bearing belongs to old product that is made up of outer ring, inner ring with center rib and small rib, two-body solid cage and some rollers. Vibration system adopts. For example, there is no structure code after 20000 code. The structure is as below:

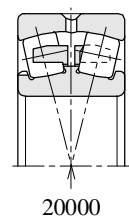

Symmetrical roller bearing contains CA type, ACA type, CB type, C type, CC type and S type.

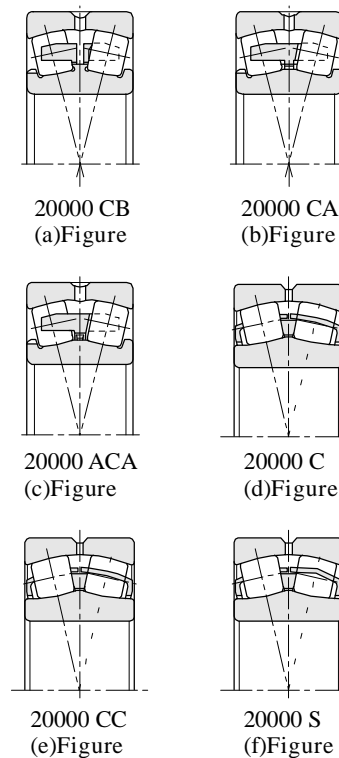

Sealed Spherical Roller Bearing

Sealed spherical roller bearing contains CA type with solid cage, sealing on basis of CB type and CC type.

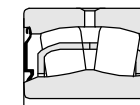

For the bearing device that has special requirements on heavy load, poor working condition and sealing, the spherical roller bearing with the structure of contact-type sealing ring in steel frame on both sides can be provide. Top of sealing ring is installed on outer ring of bearing, rotate with outer ring synchronously and stick bottom lip on raceway

of inner ring. This type of sealing ring in steel frame can be resistant to corrosion and to aging. They are common to be applied in elevator tractor which can prevent impurities entering and oil grease lost.

Vibration screen spherical roller bearings
The new type vibration resistance spherical roller bearings are VB type structure developed on basis of asymmetrical roller bearing type and CB type bearing. Some of them also use CA, CB or asymmetrical roller bearing. Vibrating machine bearings have the same boundary dimension as the basic version, and have fixed center ribs on the inner rings. They can carry axial load; The new design with special structure of cage, double guides by inner and outer diameter can control the guide gap and displacement between the cage, inner and outer rings to prevent vibration and reduce vibration. There are two kinds including cylindrical hole and tapered hole.

VB type structure is developed by ZWZ especially for vibration machinery and they can also be used on universal machinery. Performance: they have heavier carrying load capacity, impact resistance, vibration resistance, small friction, lower temperature rise and longer service life.

The code name of vibration screen spherical roller bearings is denoted with the suffix VB.

The structure is as below:

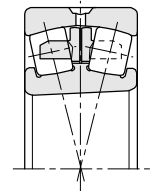

SDB Type Spherical Roller Bearing

SDB type spherical roller bearing is a new type of radial roller bearing developed on basis of cylindrical roller bearing and spherical roller bearing. They can self align automatically and get big axial displacement.

Spherical Roller Bearing

Single-row spherical roller bearings are installed with curved symmetrical rollers, with recessed ring raceway that has groove on one side or both sides. The spring lock ring or sealing ring can be installed according to requirements. Bearing has ability to self align and make axial movement. This kind of bearing is widely used in equipments of fan-shaped section in steel plant and textile industry. The main structure is as below:

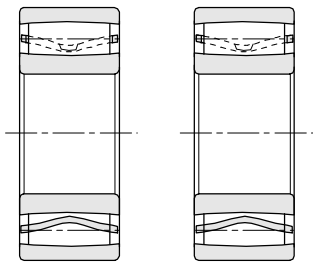

Split Spherical Roller Bearings

These bearings are mainly used in the applications where it is difficult to touch bearings or separable bearings are used and a big broken down cost caused by plenty of time and human maintenance or changing parts. For example, cranks.

ZWZ can manufacture different structures of split spherical roller bearings according to customer's demands. In order to meet the requirements of mounting, the split inner rings and outer rings are normally adopted. The jamming rings on the two sides of wide inner rings make the mounting easy.

The code name of split spherical roller bearings is denoted with the suffix D.

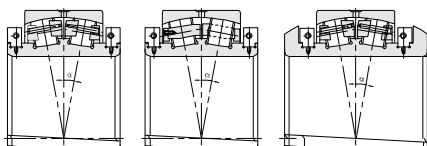

Dimension Rang:

ZWZ spherical roller bearing boundary dimensions are listed in the bearings dimensions table.

Bore diameter dimension range: 30 mm-2000mm

Outer diameter dimension range: 68mm-2700mm

Width range: 20mm-550mm

Tolerances:

ZWZ manufactures spherical roller bearings with P0 and P6 precision grades. Also ZWZ can manufacture spherical roller bearings with P5 according to customer's demands. All of tolerances values conform to GB307.1 Standard .All of tolerance values are listed in the preface table.

Radial clearances

ZWZ manufactures spherical roller bearings with C0, C2, C3, C4 and C5 clearances which are all conform to the GB4604 Standard. The C3 group clearances are taken as standard clearance for spherical roller bearings with tapered bores. The radial clearance values are listed in the preface table. These values are applied to bearings without load.

ZWZ can manufacture spherical roller bearings with non standard clearances according to customer's demands. The clearance of spherical roller bearings applied to vibration riddles is C4 group clearance.

Clearance value is shown in Table 1 and Table 2.

Vibrating machine bearing adopt big radial clearance between C3-C4.

Vibration riddles spherical roller bearings adopt C4 group clearance.

Radial clearance of SDB type spherical roller bearing is shown in Table 3.

Cage

Normally, CA type spherical roller bearings use brass, bronze cages or carbon steel solid cages.

But C type spherical roller bearings normally use pressed sheet-steel cages. Please contact with ZWZ in advance if you need spherical roller bearings with non-standard cages.

The equivalent load

The equivalent dynamic load

when $F_a / F_r \leq e$,

$$P = F_r + Y1 F_a$$

When $F_a / F_r > e$,

$$P_r = 0.67 F_r + Y2 F_a$$

The factors e, Y1 and Y2 are listed in the bearing dimension tables.

The equivalent static load

$$P_0 = F_r + Y0 F_a$$

The factors Y0 are listed in the bearing dimension tables.

Table 1 Radial clearance of spherical roller bearing with cylindrical bole μm

Nominal ID d mm		Clearance									
		Group 2		Group 0		Group 3		Group 4		Group 5	
Over	To	Min.	Max.	Min.	Max.	Min.	Max.	Min.	Max.	Min.	Max.
14	18	10	20	20	35	35	45	45	60	60	75
18	24	10	20	20	35	35	45	45	60	60	75
24	30	15	25	25	40	40	55	55	75	75	95
30	40	15	30	30	45	45	60	60	80	80	100
40	50	20	35	35	55	55	75	75	100	100	125
50	65	20	40	40	65	65	90	90	120	120	150
65	80	30	50	50	80	80	110	110	145	145	180
80	100	35	60	60	100	100	135	135	180	180	225
100	120	40	75	75	120	120	160	160	210	210	260
120	140	50	95	95	145	145	190	190	240	240	300
140	160	60	110	110	170	170	220	220	280	280	350
160	180	65	120	120	180	180	240	240	310	310	390
180	200	70	130	130	200	200	260	260	340	340	430
200	225	80	140	140	220	220	290	290	380	380	470
225	250	90	150	150	240	240	320	320	420	420	520
250	280	100	170	170	260	260	350	350	460	460	570
280	315	110	190	190	280	280	370	370	500	500	630
315	355	120	200	200	310	310	410	410	550	550	690
355	400	130	220	220	340	340	450	450	600	600	750
400	450	140	240	240	370	370	500	500	660	660	820
450	500	140	260	260	410	410	550	550	720	720	900
500	560	150	280	280	440	440	600	600	780	780	1000
560	630	170	310	310	480	480	650	650	850	850	1100
630	710	190	350	350	530	530	700	700	920	920	1190
710	800	210	390	390	580	580	770	770	1010	1010	1300
800	900	230	430	430	650	650	860	860	1120	1120	1440
900	1000	260	480	480	710	710	930	930	1220	1220	1570

Spherical Roller Bearing

Table 2 Radial clearance of spherical roller bearing with tapered bole μm

Nominal ID d mm		Clearance									
		Groub 2		Groub 0		Groub 3		Groub 4		Groub 5	
Over	To	Min.	Max.	Min.	Max.	Min.	Max.	Min.	Max.	Min.	Max.
18	24	15	25	25	35	35	45	45	60	60	75
24	30	20	30	30	40	40	55	55	75	75	95
30	40	25	35	35	50	50	65	65	85	85	105
40	50	30	45	45	60	60	80	80	100	100	130
50	65	40	55	55	75	75	95	95	120	120	160
65	80	50	70	70	95	95	120	120	150	150	200
80	100	55	80	80	110	110	140	140	180	180	230
100	120	65	100	100	135	135	170	170	220	220	280
120	140	80	120	120	160	160	200	200	260	260	330
140	160	90	130	130	180	180	230	230	300	300	380
160	180	100	140	140	200	200	260	260	340	340	430
180	200	110	160	160	220	220	290	290	370	370	470
200	225	120	180	180	250	250	320	320	410	410	520
225	250	140	200	200	270	270	350	350	450	450	570
250	280	150	220	220	300	300	390	390	490	490	620
280	315	170	240	240	330	330	430	430	540	540	680
315	355	190	270	270	360	360	470	470	590	590	740
355	400	210	300	300	400	400	520	520	650	650	820
400	450	230	330	330	440	440	570	570	720	720	910
450	500	260	370	370	490	490	630	630	790	790	1000
500	560	290	410	410	540	540	680	680	870	870	1100
560	630	320	460	460	600	600	760	760	980	980	1230
630	710	350	510	510	670	670	850	850	1090	1090	1360
710	800	390	570	570	750	750	960	960	1220	1220	1500
800	900	440	640	640	840	840	1070	1070	1370	1370	1690
900	1000	490	710	710	930	930	1190	1190	1520	1520	1860

Table 3 Radial clearance of SDB type spherical roller bearing with cylindrical bole μm

d mm		Groub 3		Groub 4		d mm		Groub 3		Groub 4	
Over	To	min	max	min	max	Over	To	min	max	min	max
18	24	39	51	51	65	180	200	238	307	307	394
24	30	46	60	60	76	200	225	262	337	337	434
30	40	55	73	73	93	225	250	282	368	368	478
40	50	65	85	85	109	250	280	307	407	407	519
50	65	79	104	104	139	280	315	330	434	434	570
65	80	96	124	124	164	315	355	360	483	483	620
80	100	120	158	158	206	355	400	395	528	528	675
100	120	144	186	186	244	400	450	435	577	577	745
120	140	166	215	215	280	450	500	475	633	633	811
140	160	195	252	252	321	500	560	518	688	688	890
160	180	217	280	280	361	560	630	567	751	751	975

Definition of Bearing Code

- ACA- Spherical roller bearing, with movable center rib and asymmetric rollers
- C- Spherical roller bearing, without rib on inner ring, with movable center rib and installed with symmetric rollers and pressed cage.
- CA- CA Spherical roller bearing, without center rib on inner ring, with small rib on both sides and installed with symmetric rollers and solid cage
- CAB-CA type Spherical roller bearing, piercing in middle of rollers with support type cage.
- CABC-CAB type Spherical roller bearing, with improved roller guiding mode (roughness of roller surface, roughness of raceway surface, heating treatment changes, etc.), to reduce friction.
- CAC-CA type Spherical roller bearing, with improved roller guiding mode (roughness of roller surface, roughness of raceway surface, heating treatment changes, etc.), to reduce friction.
- CB- Continuous casting bearing
- CC-C type Spherical roller bearing, with improved roller guiding mode (roughness of roller surface, roughness of raceway surface, heating treatment changes, etc.), to reduce friction.
- /C3- Clearance meets 3 group as specified in standard
- /C4 - Clearance meets 4 group as specified in standard
- /C9- Bearing clearance is different from current standard
- /CRA9- Radial clearance is nonstandard, with requirements on axial clearance
- D- Split bearing

Spherical Roller Bearing

- F1- Carbon steel
- F3- Nodular cast iron
- /P5- Tolerance meets Level 5 as specified in standard
- /P6- Tolerance meets Level 6 as specified in standard
- /HA- Ring, rolling elements and cage, or only the ring and rolling elements are made of vacuum smelting bearing steel
- /HC- Ring and rolling elements or only the ring or only the rolling elements alone is made up of carbon steel (/HC-20Cr 2Ni4A;/HC1-20Cr2Mn2MoA;/HC2-15Mn;/HC3-G20CrMo)
- /HCR- Shows to distinguish the same series that rolling elements are made up of carbon steel
- /HG- Ring and rolling elements or only the ring is made up of other bearing steel (/HG-5 Gr MnMo;/HG1-55SiMoVA;K/HG2-GCr18Mo;/HG3-42CrMo;/HG4-GCr15SiMn)
- K- Bearing with tapered bore, tapered 1:12
- K30- Bearing with tapered bore, tapered 1:30
 - L- Light alloy solid cage. When material of cage changes, express with attached digits.
 - N- Bearing with snap ring groove on outer ring
 - NR- Bearing with snap ring groove on outer ring and retainer ring
 - Q1- Aluminium, Fe and Mn bronze materials
- 2RS- Bearing with RS sealing on both sides
- 2RS2- Bearing with steel skeleton rubber fluoride on both sides
 - S- When ID is less than 65mm, the structure is similar with CC type and outline of the cage is made up of two pieces of broken line.
- /S0- After high-temperature tempering to bearing ring, the working temperature can reach 150°C
- /S1- After high-temperature tempering to bearing ring, the working temperature can reach 200°C
- /S2- After high-temperature tempering to bearing ring, the working temperature can reach 250°C
- /S3- After high-temperature tempering to bearing ring, the working temperature can reach 300°C
- /S4- After high-temperature tempering to bearing ring, the working temperature can reach 350°C
- SDB- Structure code, single-row spherical roller bearing that can self-align and make axial displacement.
- TN1- Nylon
 - V- Full complement rolling elements(without cage)
- VB- Vibrating screen bearing
- /W20- There are 3 lubrication holes on outer ring of bearing (without oil groove)
- /W33- There are an oil groove and 3 lubrication holes on outer ring of bearing]
- /W33T- There are 8 lubrication holes on outer ring of bearing
- /W33X- There are an oil groove and 6 lubrication holes on outer ring of bearing
 - X1- Outer diameter is nonstandard
 - X2- Width (height) is nonstandard
 - X3- Outer diameter and width (height) are nonstandard (standard inner diameter)

- YAB- Structure and technique are required to change at the same time
- YAD- The same type of bearing, no less than two changes of the structure at the same time
- YA1- Outside surface of bearing outer ring is different from standard design
- YA2- Inner bore of bearing inner ring is different from standard design
- YA3- End face of bearing ring is different from standard design
- YA6- Mounting chamfer of bearing is different from standard design
- YA7- Rib or retainer ring of bearing is different from standard design
- YA8- Cage structure changes
- YB2- Dimension and tolerance of bearing change
 - /Z- Bearing vibration accelerated speed magnitude extreme value category (Z1- with specified vibration accelerated speed magnitude extreme value; Z2- vibration accelerated speed magnitude extreme value is less than Z1 group; Z3- vibration accelerated speed magnitude extreme value is less than Z2 group)
 - /V- Bearing vibration speed magnitude extreme value category (V1- with specified vibration speed magnitude extreme value; V2- vibration speed magnitude extreme value is less than V1 group; V3- vibration speed magnitude extreme value is less than V2 group)

Adapter Sleeve and Withdrawal Sleeve

Adapter sleeve and withdrawal sleeve supplied by ZWZ can install optical shaft and stepped shaft into spherical roller bearing with tapered bore easily and rapidly.

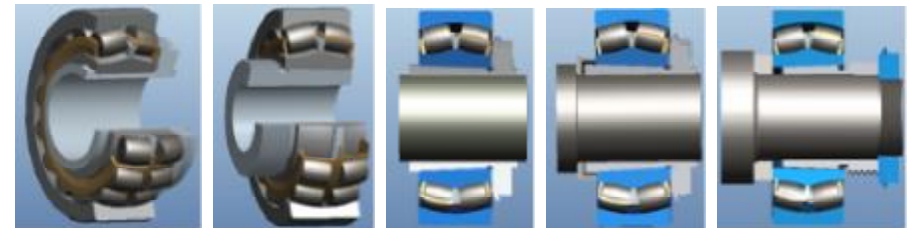

Bearing with adapter sleeve

Bearing with withdrawal sleeve

Adapter sleeve is installed on the optical shaft

Adapter sleeve is installed on the stepped shaft

Withdrawal sleeve is installed on the stepped shaft

Adapter Sleeve Design

Adapter sleeve is one of the most commonly used bearing accessories which is used to fix the bearing with tapered bore on cylindrical journal including optical shaft and stepped shaft. This kind of accessory is easy to mount and needn't be fixed by other devices. When using adapter sleeve on the optical shaft, bearing can be fixed anywhere on the shaft.

When used as stepped shaft and cooperating with stepped ring, bearing can be fixed to the given place more accurately on the shaft and also relatively easy to dismount. Adapter sleeve provided by ZWZ has lock nut and necessary locking device shown as figure below. For small adapter sleeve, locking nut is fixed by lock washer. For big adapter sleeve, locking nut is fixed by a locking clasp. There is a slit on the adapter sleeve, the surface taper

Spherical Roller Bearing

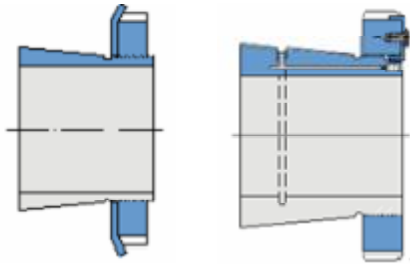

is 1:12. For the surface of adapter sleeve with size 40 or less than 40, it is after phosphating. For the adapter sleeve with larger size, adopt undissolved antirusting agent to protect adapter sleeve surface.

Oil injection method can simplify mounting and dismounting of bearing. In order to cooperate with this method, ZWZ can provide the design with an oil path and oil groove that you can choose from. The oil entrance is on one side with screw thread of adapter sleeve; oil groove is on the cone surface of adapter sleeve. After injecting hydraulic oil into oil path and oil groove, it will form a layer of oil film on the matching surface of bearing and adapter sleeve, which can significantly reduce the force needed for installation of bearing. This kind of standard adapter sleeve code is OH...H.

Common Information and Data

Dimension

Dimension of adapter sleeve conforms to standard ISO2982-1:1995.

Tolerance

Tolerance of ZWZ adapter sleeve conforms to standard JB/T7919.

Screw Thread

For ZWZ adapter sleeve with size 40 or more

than 40, metric screw thread tolerance is 6g and conforms to standard I SO9653:1998 standard. For large size adapter sleeve, metric screw thread tolerance is 7e and conforms to standard ISO2903: 1993 standard.

Requirements of Shaft Tolerance

Because adapter sleeve is installed on shaft to work in concert with bearing, it has larger tolerance range than that is directly installed on cylindrical journal. But geometrical tolerance must keep in very narrow range, for precision of geometrical tolerance will influence rotation precision of bearing directly. Generally, shaft tolerance is h9 according to ISO1101:1983 standard and cylindricity should be IT5/2.

Withdrawal Sleeve

Design

Withdrawal sleeve is mainly used to fix bearing with tapered bore to cylindrical journal on steeped shaft. Withdrawal sleeve is pressed into shaft shoulder or similar devices between the bearing with tapered bore and shaft, then fixed on the shaft by nut or end plate. For screw thread of shaft end has different dimension according to actual application, lock nut or end plate will not be supplied with withdrawal sleeve and need be ordered separately. Besides, the nuts for dismounting the withdrawal sleeve also need to be ordered separately.

Surface of ZWZ withdrawal sleeve is coated with antirust agent, with a slit and the taper of surface is 1:12.

The nuts for dismounting the withdrawal sleeve also need to be ordered separately.

Oil injection method can simplify mounting and dismounting of bearing. In order to

cooperate with this method, ZWZ can provide the design with an oil path and oil groove that you can choose from. There are two oil entrances on one side with screw thread of AOH withdrawal sleeve. There are some oil grooves along the circumferential and axial direction on the cone surface and cylindrical inner surface. After injecting hydraulic oil into oil path and oil groove, it will form a layer of oil film on the matching surface of bearing and withdrawal sleeve as well on the matching surface of shaft and withdrawal sleeve, which can significantly reduce the force needed for installation of bearing.

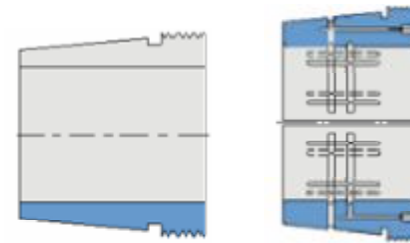

Common Information and Data

Dimension

Dimension of adapter sleeve conforms to standard ISO2982-1:1995.

Tolerance

Tolerance of ZWZ adapter sleeve conforms to standard JB/T7919.

Screw Thread

For ZWZ adapter sleeve with size 40 or more than 40, metric screw thread tolerance is 6g and conforms to standard I SO9653:1998 standard. For large size adapter sleeve, metric screw thread tolerance is 7e and conforms to standard ISO2903: 1993 standard.

Requirements of Shaft Tolerance

Because adapter sleeve is installed on shaft to work in concert with bearing, it has larger tolerance range than that is directly installed on cylindrical journal. But geometrical tolerance must keep in very narrow range, for precision of geometrical tolerance will influence rotation precision of bearing directly. Generally, shaft tolerance is h9 according to ISO1101:1983 standard and cylindricity should be IT5/2.

Spherical Roller Bearing(CA)

d 30-60 mm

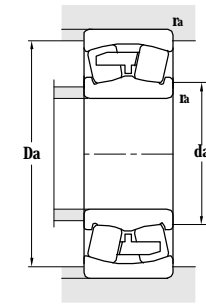
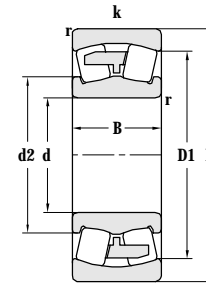
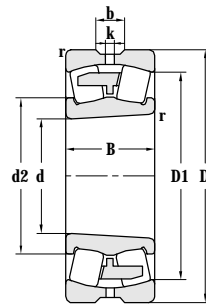
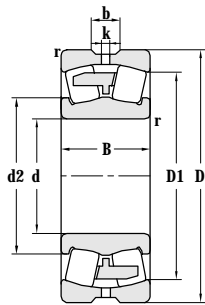

Principal dimensions				Basic load ratings		Limit speed ratings		Designations	
d	D	B	r _{min}	C _r	C _{Or}	Grease	Oil		
mm				kN		r/min			
30	68	20	1	60.8	57	6000	7500	22206X1CAN	
35	72	23	1.1	72.5	81.5	6000	7500	22207CA/W33	
	82	23	0.5	86	92	6000	7500	21307X3CA/CRA9	
40	90	33	1.5	143	133	4500	5600	22308CA	
	90	33	1.5	143	133	4500	5600	22308CH/W33	
	90	33	1.5	143	133	4500	5600	22308CAK	
45	85	23	1.1	96.9	95	5300	6700	22209CA	
	100	36	1.5	174	174	3800	4800	22309CA	
	100	36	1.5	174	174	3800	4800	22309CAK	
50	90	23	1.1	98.8	103	5000	6300	22210CA	
	90	23	1.1	98.8	103	5000	6300	22210/W33	
	90	23	1.1	98.8	103	5000	6300	22210CAK	
	110	27	2	148	158	3400	4300	21310CA/C3	
	110	40	2	209	213	3400	4300	22310CA	
	110	40	2	209	213	3400	4300	22310CA/W33A	
	110	40	2	209	213	3400	4300	22310CAK	
55	100	25	1.5	119	126	4500	5600	22211CA	
	100	25	1.5	119	126	4500	5600	22211CAK	
	100	25	1.5	101	126	4500	5600	22211/W33	
	100	25	1.5	101	126	4500	5600	22211K/W33	
	120	43	2	257	266	3200	4000	22311CA	
	120	43	2	257	266	3200	4000	22311CA/YB2	
	120	43	2	257	266	3200	4000	22311CAK	
	60	110	28	1.5	148	158	4000	5000	22212CA
		110	28	1.5	148	158	4000	5000	22212CAK/W33
110		28	1.5	121	145	4000	5000	22212	
130		46	2.1	225	248	3000	3800	22312	
130		46	2.1	225	248	3000	3800	22312K	
130		46	2.1	295	318	3000	3800	22312CA	
130		46	2.1	295	318	3000	3800	22312CA/W33	
130		46	2.1	295	318	3000	3800	22312CA/C9-ZG	
130		46	2.1	295	318	3000	3800	22212CA/W33/S0	
130		46	2.1	295	318	3000	3800	22212/W33	

Other dimensions				Contact surface and chamfer dimensions			Calculation coefficient				Weight
d2	D1	b	k	da	Da	ra	e	Y1	Y2	Y0	
mm				mm			mm				kg
41	52.3			37	60	1	0.32	2.09	3.11	2.04	0.384
46	60	5.5	3	41	65	1					0.441
	83	69		42	75						0.652
56	74	5.5	2.5	49	81	1.5	0.39	1.73	2.58	1.69	1.02
49.9	74.3	5.5	3	49	81	1.5	0.37	1.80	2.70	1.80	1.01
56	74	5.5	2.5	49	81	1.5	0.39	1.73	2.58	1.69	0.993
57.6	73	5.5	2	52	78	1	0.28	2.40	3.50	2.50	0.629
63	81.4	5.5	2.5	54	91	1.5	0.38	1.80	2.60	1.70	1.53
63	81.4	5.5	2.5	54	91	1.5	0.38	1.80	2.60	1.70	1.52
62.2	81.6	5.5	2	57	83	1	0.26	2.60	3.90	2.50	0.630
63	81.6	5.5	2	57	83	1	0.27	2.50	3.70	2.50	0.629
62.2	81.6	5.5	2	57	83	1	0.26	2.60	3.90	2.50	0.630
69	92			60	100	2	0.24	2.80	4.20	2.80	1.34
69	90.6	5.5	2.5	60	100	2	0.38	1.80	2.60	1.70	2.17
69	90.6	5.5	2.5	60	100	2	0.38	1.80	2.60	1.70	2.06
69	90.6	5.5	2.5	60	100	2	0.38	1.80	2.60	1.70	2.13
68.8	87.3	5.5	2	64	91	1.5	0.25	2.70	4.00	2.60	0.887
68.8	87.3	5.5	2	64	91	1.5	0.25	2.70	4.00	2.60	0.879
70	87.3	5.5	2	64	91	1.5	0.26	2.60	3.90	2.50	0.742
70	87.3	5.5	2	64	91	1.5	0.26	2.60	3.90	2.50	0.724
75	99.5	5.5	2.5	65	110	2	0.37	1.80	2.70	1.80	2.60
75	99.5	5.5	2.5	65	110	2	0.37	1.80	2.70	1.80	2.60
75	99.5	5.5	2.5	65	110	2	0.37	1.80	2.70	1.80	2.42
75.2	95	5.5	2	69	101	1.5	0.24	2.80	4.20	2.80	1.01
75.2	95	5.5	2	69	101	1.5	0.24	2.80	4.20	2.80	0.982
75.5	95	5.5	2	69	101	1.5	0.27	2.50	3.70	2.50	1.09
79	108	5.5	3	72	118	2	0.40	1.68	2.50	1.64	2.93
79	108	5.5	3	72	118	2	0.40	1.68	2.50	1.64	2.86
81.4	108	5.5	3	72	118	2	0.37	1.80	2.70	1.80	3.33
81.4	108	5.5	3	72	118	2	0.37	1.80	2.70	1.80	3.33

Spherical Roller Bearing (CA)

d 60-80 mm

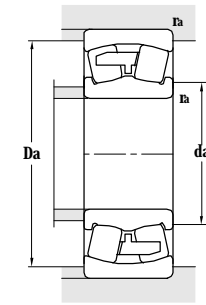
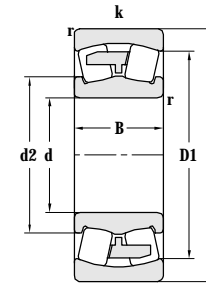
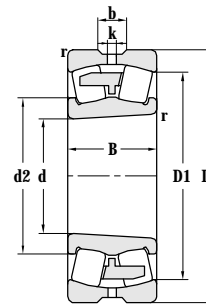
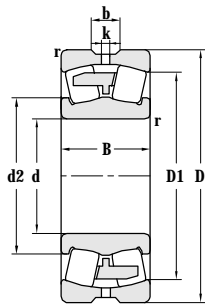

Principal dimensions				Basic load ratings		Limit speed ratings		Designations	
d	D	B	r _{min}	C _r	C _{0r}	Grease	Oil		
mm				kN		r/min			
60	130	46	2.1	295	318	3000	3800	22312CA/YB2	22312CAF3
	130	46	2.1	295	318	3000	3800	22312CAK	22312CAK/W33
65	120	31	1.5	183	205	3800	4800	22213CA	22213CA/W33
	120	31	1.5	183	205	3800	4800	22213CAK	22213CAK/W33
	120	31	1.5	170	216	3800	4800	22213S/W33	
	120	31	1.5	143	175	3800	4800	22213/W33	
	120	31	1.5	143	175	3800	4800	22213K/W33	
	140	33	2.1	224	257	2800	3600	21313CA	
	140	48	2.1	262	325	2600	3400	22313CH/W33	
	140	48	2.1	323	342	2600	3400	22313CA	22313CA/W33
	140	48	2.1	323	342	2600	3400	22313CAF3	22313CAKF3
	140	48	2.1	323	342	2600	3400	22313CAK	22313CAK/W33
70	125	31	1.5	162	205	3600	4500	22214CA	22214CA/W33
	125	31	1.5	162	205	3600	4500	22214CAK	
	125	31	1.5	159	200	3600	4500	22214/W33	
	150	35	2.1	270	309	2400	3200	21314CA	
	150	51	2.1	380	408	2200	3000	22314CA	22314CA/W33
	150	51	2.1	380	408	2200	3000	22314CAK	22314CAK/W33
	150	51	2.1	380	408	2200	3000	22314CAF3	22314CAKF3
75	115	40	1.1	164	250	2900	3500	24015CA	24015CA/W33
	130	31	1.5	150	192	3400	4300	22215	
	130	31	1.5	201	228	3400	4300	22215CA	22215CA/W33
	130	31	1.5	201	228	3400	4300	22215CAK	
	160	55	2.1	418	451	2200	3000	22315CA	22315CA/W33
	160	55	2.1	418	451	2200	3000	22315CAF3	22315CAF3/W33
	160	55	2.1	418	451	2200	3000	22315CAK	22315CAK/W33
	80	140	33	2	165	225	3200	4000	22216CA
140		33	2	165	225	3200	4000	22216CAK	
170		58	2.1	380	495	2000	2800	22316CA	22316CA/W33
170		58	2.1	380	495	2000	2800	22316CA/C9-ZG	
170		58	2.1	380	495	2000	2800	22316CA/HAC9W33YA8	
170		58	2.1	380	495	2000	2800	22316CAF3	

Other dimensions				Contact surface and chamfer dimensions			Calculation coefficient				Weight
d2	D1	b	k	da	Da	ra	e	Y1	Y2	Y0	
mm				mm			mm				kg
81.4	108			72	118	2	0.37	1.80	2.70	1.80	3.33
81.4	108	5.5	3	72	118	2	0.37	1.80	2.70	1.80	3.33
81.5	103	5.5	2.5	74	111	1.5	0.25	2.70	4.00	2.50	1.56
81.5	103	5.5	2.5	74	111	1.5	0.25	2.70	4.00	2.50	1.52
80	106	5.5	3	74	111	1.5	0.25	2.70	4.00	2.50	1.57
82	103	5.5	2.5	74	111	1.5	0.27	2.50	3.70	2.50	1.57
82	103	5.5	2.5	74	111	1.5	0.27	2.50	3.70	2.50	1.54
87.9	119			77	128	2	0.25	2.70	4.00	2.60	2.58
81.6	118	8.3	4.5	77	128	2	0.35	1.90	2.90	1.80	4.92
88.6	116	5.5	3	77	128	2	0.35	1.90	2.90	1.80	4.92
88.6	116			77	128	2	0.35	1.90	2.90	1.80	4.90
88.6	116	5.5	3	77	128	2	0.35	1.90	2.90	1.80	4.90
86.8	109	6	2.5	79	116	1.5	0.24	3.00	4.60	2.80	1.83
86.8	109			79	116	1.5	0.24	3.00	4.60	2.80	1.81
87.2	109	6	2.5	79	116	1.5	0.26	2.60	3.90	2.50	1.66
95.4	127			82	138	2	0.25	2.70	4.00	2.60	3.02
95.8	125	8.3	4	82	138	2	0.35	1.90	2.90	1.80	5.23
95.8	125	8.3	4	82	138	2	0.35	1.90	2.90	1.80	5.21
95.8	125			82	138	2	0.35	1.90	2.90	1.80	5.14
87.5	100	5.5	3	82	106	1	0.32	2.09	3.11	2.04	1.48
92	114			84	121	1.5					1.73
92	114	5.5	2.5	84	121	1.5	0.24	3.00	4.60	2.80	1.71
92	114			84	121	1.5	0.24	3.00	4.60	2.80	1.67
101	133	8.3	4	87	148	2	0.35	1.90	2.90	1.80	5.44
101	133	8.3	4	87	148	2	0.35	1.90	2.90	1.80	5.40
101	133	8.3	4	87	148	2	0.35	1.90	2.90	1.80	5.32
98.9	122	5.5	2.5	91	129	2	0.24	2.80	4.20	2.80	2.08
98.9	122			91	129	2	0.24	2.80	4.20	2.80	2.03
109	142	8.3	4	92	158	2	0.34	1.99	2.96	1.94	7.47
109	142	8.3	4	92	158	2	0.34	1.99	2.96	1.94	6.54
109	142	8.3	4	92	158	2	0.34	1.99	2.96	1.94	7.36
109	142			92	158	2	0.34	1.99	2.96	1.94	7.34

Spherical Roller Bearing(CA)

d 80-95 mm

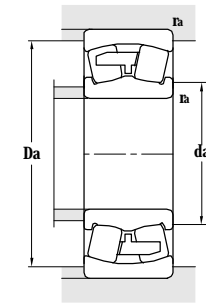
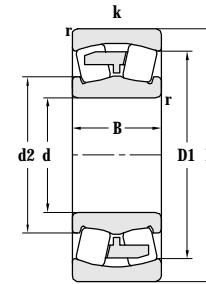
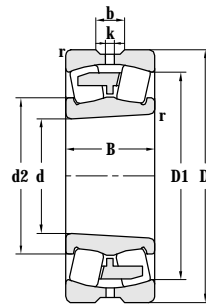
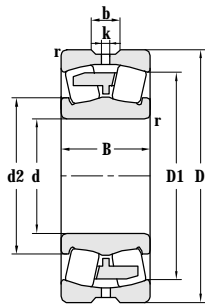

Principal dimensions				Basic load ratings		Limit speed ratings		Designations
d	D	B	r _{min}	C _r	C _{OR}	Grease	Oil	
mm				kN		r/min		
80	170	58	2.1	380	495	2000	2800	22316CAK
82.6	170	58	2.1	380	495	2000	2800	206/82.6CA/W33
85	150	36	2	193	254	3000	3800	22217CA 22217CA/W33
	150	36	2	193	254	3000	3800	22217CAK
	180	41	3	294	360	2000	2800	21317CA 21317CA/W33
	180	60	3	391	505	1900	2600	22317CA 22317CA/W33
	180	60	3	390	505	1900	2600	22317ACA
	180	60	3	391	505	1900	2600	22317CAF3
	180	60	3	391	505	1900	2600	22317CAK 22317CAK/W33
	180	60	3	391	505	1900	2600	22317CAKF3 22317CAKF3/W33
90	140	50	1.5	233	390	2600	3400	24018CA 24018CA/W33
	160	40	2	269	360	2600	3400	22218CA 22218CA/W33
	160	40	2	269	360	2600	3400	22218CAF3
	160	40	2	269	360	2600	3400	22218CAK 22218CAK/W33
	160	52.4	2	287	415	2000	2800	23218 23218/W33
	160	52.4	2	287	415	2000	2800	23218K 23218K/W33
	160	52.4	2	287	415	2000	2800	23218F3
	160	52.4	2	337	475	1900	2600	23218CA 23218CA/W33
	160	52.4	2	369	480	1900	2600	23218CA/HAC9SOW24
	160	52.4	2	337	475	1900	2600	23218CAK 23218CAK/W33
	160	67	2	334	475	1900	2600	24218X2CA/YB2
	190	64	3	580	660	1800	2400	22318CA 22318CA/W33
	190	64	3	580	660	1800	2400	22318CAF3 22318CAKF3
	190	64	3	580	660	1800	2400	22318CAK 22318CAK/W33
	190	64	3	580	660	1800	2400	22318ACA
	190	64	3	400	505	1800	2400	22318
	190	64	3	400	505	1800	2400	22318K 22318K/W33
	190	43	3	580	660	2400	3200	21318CA/W33
95	170	43	2.1	361	428	2400	3200	22219CA 22219CA/W33
	170	43	2.1	361	428	2400	3200	22219CAK
	200	45	3	404	466	2400	3200	21319CA/W33
	200	67	3	637	727	1800	2400	22319

Other dimensions				Contact surface and chamfer dimensions			Calculation coefficient				Weight
d2	D1	b	k	da	Da	ra	e	Y1	Y2	Y0	
mm				mm			mm				kg
109	142			92	158	2	0.34	1.99	2.96	1.94	7.40
109	142	8.3	4	92	158	2	0.34	1.99	2.96	1.94	6.37
105	132	6.5	3	96	139	2	0.24	2.80	4.20	2.80	2.69
105	132			96	139	2	0.24	2.80	4.20	2.80	2.64
118	152			99	166	2.5	0.24	2.80	4.20	2.80	5.42
115	150	8.3	4	99	166	2.5	0.34	1.99	2.96	1.94	8.19
115	150	8.3	4	99	166	2.5	0.34	1.99	2.96	1.94	8.19
115	150			99	166	2.5	0.34	1.99	2.96	1.94	8.12
115	150	8.3	4	99	166	2.5	0.34	1.99	2.96	1.94	8.08
115	150	8.3	4	99	166	2.5	0.34	1.99	2.96	1.94	8.01
106	121	5.5	3	100	125	1.5	0.33	2.00	3.00	2.00	3.25
111	139	8.3	2.5	101	149	2	0.25	2.70	4.00	2.60	3.40
111	139			101	149	2	0.25	2.70	4.00	2.60	3.38
111	139	8.3	2.5	101	149	2	0.25	2.70	4.00	2.60	3.28
111	133	5.5	2.5	101	149	2	0.35	1.90	2.90	1.80	4.64
111	133	5.5	2.5	101	149	2	0.35	1.90	2.90	1.80	4.5
111	133			101	149	2	0.35	1.90	2.90	1.80	4.61
112	136	5.5	2.5	101	149	2	0.25	2.70	4.00	2.60	4.82
112	136	5.5	2.5	101	149	2	0.25	2.70	4.00	2.60	4.72
112	136	5.5	2.5	101	149	2	0.25	2.70	4.00	2.60	4.55
112	136			101	149	2	0.31	2.20	3.30	2.20	5.87
123	159	8.3	5	104	176	2.5	0.34	1.99	2.96	1.94	11.5
123	159			104	176	2.5	0.34	1.99	2.96	1.94	11.2
123	159	8.3	5	104	176	2.5	0.34	1.99	2.96	1.94	11.1
123	159			104	176	2.5	0.34	1.99	2.96	1.94	9.44
121	159			104	176	2.5	0.36	1.87	2.79	1.83	8.62
121	159	8.3	5	104	176	2.5	0.36	1.87	2.79	1.83	8.43
112	150	8.3	4.5	104	176	2.5	0.24	2.80	4.20	2.80	5.82
119	148	8.3	3	107	158	2	0.24	2.80	4.20	2.80	4.68
119	148	8.3	3	107	158	2	0.24	2.80	4.20	2.80	4.48
112	150	8.3	4.5	107	158	2	0.24	2.80	4.20	2.80	7.48
128	167			109	186	2.5					10.4

Spherical Roller Bearing(CA)

d 95-110 mm

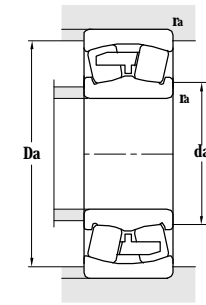
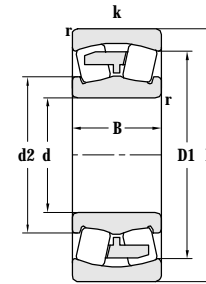
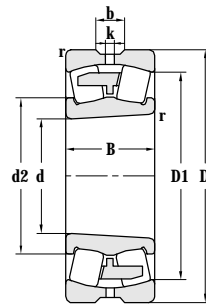
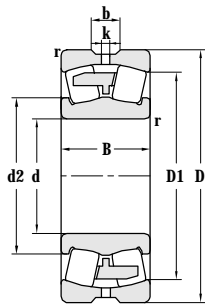

Principal dimensions				Basic load ratings		Limit speed ratings		Designations	
d	D	B	r _{min}	C _r	C _{Or}	Grease	Oil		
mm				kN		r/min			
95	200	67	3	637	727	1800	2400	22319CA	22319CA/W33
	200	67	3	637	727	1800	2400	22319CAF3	22319CAK
	200	67	3	637	727	1800	2400	22319CAKF3	22319CAKF3/W33
100	150	37	1.5	215	400	2400	3200	23020CA	
	150	50	1.5	271	445	2400	3200	24020CA/W33	
	165	52	2	347	510	2000	2800	23120CA	23120CA/W33
	165	52	2	347	510	2000	2800	23120CAK/W33	
	165	52	2	347	465	2000	2800	23120K/W33	
	180	46	2.1	404	466	2200	3000	22220	
	180	46	2.1	404	466	2200	3000	22220CA	22220CA/W33
	180	46	2.1	404	466	2200	3000	22220CAF3	22220CAKF3
	180	46	2.1	404	466	2200	3000	22220CAK	22220CAK/W33
	180	60.3	2.1	400	570	1700	2200	23220F1/W33	
	180	60.3	2.1	451	610	1700	2200	23220CA	23220CA/W33
	180	60.3	2.1	451	610	1700	2200	23220CAK/W33	23220CAKF3/W33
	215	47	3	385	490	1700	2200	21320CA	
	215	73	3	774	903	1700	2200	22320CA	22320CA/W33
	215	73	3	774	903	1700	2200	22320CAF3	22320CAKF3
215	73	3	774	903	1700	2200	22320CAK	22320CAK/W33	
105	175	56	2	402	550	1900	2700	23121CA	23121CAL
	175	56	2	402	550	1900	2700	23121CA/W33	
110	170	45	2	295	460	2200	3000	23022CA	23022CA/W33
	170	45	2	295	460	2200	3000	23022CAF3	23022CAF3/W33
	170	60	2	394	589	2100	2800	24022CA	24022CA/W33
	170	60	2	394	589	2100	2800	24022CA/W33A	
	180	56	2	409	580	1900	2600	23122CA	23122CAK/C3W33
	180	56	2	409	580	1900	2600	23122CAF3	
	180	56	2	409	580	1900	2600	23122CAKF3/W33	
	180	82	3	510	870	1000	1400	24122X2TN1/YA6	
	180	69	2	494	750	1000	1400	24122F1/W33	
	180	69	2	494	750	1000	1400	24122CA	24122CA/W33
	200	53	2.1	530	610	2000	2800	22222CA	22222CA/W33
	200	53	2.1	530	610	2000	2800	22222CAF3	

Other dimensions				Contact surface and chamfer dimensions			Calculation coefficient				Weight
d2	D1	b	k	da	Da	ra	e	Y1	Y2	Y0	
mm				mm			mm				kg
128	167	8.3	5	109	186	2.5	0.34	1.99	2.96	1.94	10.5
128	167			109	186	2.5	0.34	1.99	2.96	1.94	10.5
128	167	8.3	5	109	186	2.5	0.34	1.99	2.96	1.94	10.3
116	135			110	140	1.5	0.23	2.90	4.40	2.80	2.52
115	133	5.5	3	110	140	1.5	0.30	2.25	3.35	2.20	3.18
121	143	5.5	3	110	155	2	0.30	2.90	4.40	2.80	4.42
121	143	5.5	3	110	155	2	0.30	2.90	4.40	2.80	4.26
121	143	5.5	3	110	155	2	0.30	2.25	3.35	2.20	4.44
126	156			112	168	2					5.24
124	156	8.3	3	112	168	2	0.24	2.80	4.20	2.80	5.18
124	156			112	168	2	0.24	2.80	4.20	2.80	5.10
124	156	8.3	3	112	168	2	0.24	2.80	4.20	2.80	4.96
125	153	9.5	4	112	168	2					6.39
125	153	9.5	4	112	168	2	0.33	2.00	3.00	2.00	6.52
125	153	9.5	4	112	168	2	0.33	2.00	3.00	2.00	6.21
138	179			114	201	2.5					8.74
138	179	11.1	5	114	201	2.5	0.35	1.90	2.90	1.80	13.8
138	179			114	201	2.5	0.35	1.90	2.90	1.80	13.4
138	179	11.1	5	114	201	2.5	0.35	1.90	2.90	1.80	13.8
127	151			115	165	2	0.31	2.20	3.30	2.20	5.48
127	151	5.5	3	115	165	2	0.31	2.20	3.30	2.20	5.35
128	150	7.5	3	120	160	2	0.25	2.70	4.00	2.60	3.58
128	150	7.5	3	120	160	2	0.25	2.70	4.00	2.60	3.54
128	150	5.5	3	120	160	2	0.32	2.09	3.11	2.04	4.98
128	150	5.5	3	120	160	2	0.32	2.09	3.11	2.04	4.90
132	156	5.5	3	120	170	2	0.30	2.25	3.35	2.20	5.73
132	156			120	170	2	0.30	2.25	3.35	2.20	5.70
132	156	5.5	3	120	170	2	0.30	2.25	3.35	2.20	5.51
123	148										7.56
131	153	5.5	2.5	120	170	2					6.91
131	153	5.5	2.5	120	170	2	0.35	1.90	2.90	1.80	6.92
139	173	8.3	4	122	188	2	0.26	2.60	3.90	2.50	7.43
139	173			122	188	2	0.26	2.60	3.90	2.50	7.37

Spherical Roller Bearing(CA)

d 110~120 mm

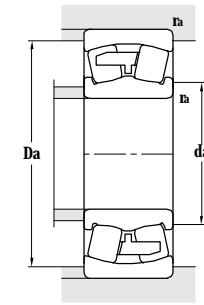
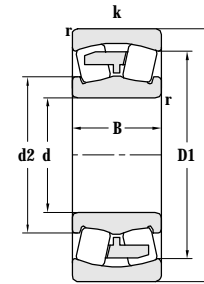
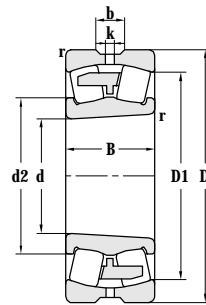
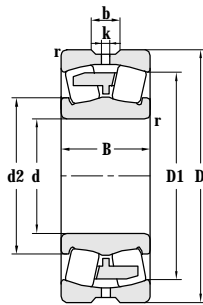

Principal dimensions				Basic load ratings		Limit speed ratings		Designations	
d	D	B	r _{min}	C _r	C _{Or}	Grease	Oil		
mm				kN		r/min			
110	200	53	2.1	530	610	2000	2800	22222CAK 22222CAK/W33	
	200	69.8	2.1	570	727	1600	2000	23222CA 23222CA/W33	
	200	69.8	2.1	570	727	1600	2000	23222CAF3 23222CAF3/W33	
	200	69.8	2.1	570	727	1600	2000	23222CAK 23222CAK/W33	
	200	69.8	2.1	570	727	1600	2000	23222CAKF3	
	200	69.8	2.1	490	740	1700	2200	23222/W33	
	240	80	3	900	1060	1600	2000	22322CA 22322CA/W33	
	240	80	3	900	1060	1600	2000	22322CAF3 22322CAF3/W33	
	240	80	3	900	1060	1600	2000	22322CAK 22322CAK/W33	
	240	50	3	420	490	1600	2000	21322CA/W33	
	120	180	46	2	340	495	2000	2800	23024CA 23024CA/W33
		180	46	2	340	495	2000	2800	23024CAK 23024CA/W33
180		46	2	340	495	2000	2800	23024CAKF3/W33	
180		46	2	340	495	2000	2800	23024CA/W33A	
180		60	2	410	660	1600	2000	24024CA 24024CA/W33	
180		60	2	410	660	1600	2000	24024CA/W513	
180		60	2	410	660	1600	2000	24024F1/W33	
200		62	2	490	715	1800	2400	23124CA/W33 23124CAK/W33	
200		62	2	430	715	1900	2600	23124/W33	
200		62	2	430	715	1900	2600	23124K	
200		80	2	620	925	1400	1800	24124CA 24124CA/W33	
200		80	2	620	925	1400	1800	24124CAF3	
200		80	2	620	925	1400	1800	24124CAK30/W33	
215		58	2.1	600	730	1900	2600	22224CA 22224CAF3	
215		58	2.1	600	730	1900	2600	22224CA/W33	
215		58	2.1	600	730	1900	2600	22224CAK 22224CAK/W33	
215		58	2.1	600	730	1900	2600	22224CAKF3 22224CAKF3/W33	
215		76	2.1	660	940	1500	1900	23224CA 23224CA/W33	
215		76	2.1	660	940	1500	1900	23224CAF3/W33	
215		76	2.1	660	940	1500	1900	23224CAK/W33 23224CAK/W33	
240		100	2	570	925	1500	1900	24124X3CA/C9WN33	
260		86	3	920	1060	1400	1800	22324 22324/W33	
260		86	3	920	1060	1400	1800	22324K 22324K/W33	
260		86	3	920	1060	1400	1800	22324KF3 22324KF3/W33	
260		86	3	920	1060	1400	1800	22324F3 22324F3/W33	

Other dimensions				Contact surface and chamfer dimensions			Calculation coefficient				Weight
d2	D1	b	k	da	Da	ra	e	Y1	Y2	Y0	
mm				mm	mm	mm	mm				kg
139	173	8.3	4	122	188	2	0.26	2.60	3.90	2.50	7.25
138	168	12	5	122	188	2	0.34	1.99	2.96	1.94	10.1
138	168	12	5	122	188	2	0.34	1.99	2.96	1.94	9.79
138	168	12	5	122	188	2	0.34	1.99	2.96	1.94	9.83
138	168	12	5	122	188	2	0.34	1.99	2.96	1.94	9.77
139	168	12	5	122	188	2	0.35	1.90	2.90	1.80	9.54
151	197	13.9	6	122	188	2.5	0.31	2.20	3.30	2.20	18.9
151	197	13.9	6	122	188	2.5	0.31	2.20	3.30	2.20	18.7
151	197	13.9	6	122	188	2.5	0.31	2.20	3.30	2.20	18.5
150	202	7.5	3								11.7
139	162	5.5	3	130	170	2	0.23	2.90	4.40	2.80	4.44
139	162	5.5	3	130	170	2	0.23	2.90	4.40	2.80	4.42
139	162	5.5	3	130	170	2	0.23	2.90	4.40	2.80	4.34
139	162	7	4	130	170	2					4.39
139	158	5.5	4	130	170	2	0.31	2.20	3.30	2.20	5.83
139	158	5.5	4	130	170	2	0.31	2.20	3.30	2.20	5.79
139	158	5.5	4	130	170	2					5.5
146	174	5.5	3	130	190	2	0.30	2.30	3.40	2.20	12.2
146	174	5.5	3	130	190	2	0.31	2.20	3.30	2.20	7.97
146	174	5.5	3	130	190	2	0.31	2.20	3.30	2.20	7.73
146	167	5.5	3	130	190	2	0.30	2.30	3.40	2.20	10
146	167	5.5	3	130	190	2	0.30	2.30	3.40	2.20	9.95
146	167	5.5	3	130	190	2	0.30	2.30	3.40	2.20	9.88
149	187			132	203	2	0.26	2.60	3.90	2.50	9.87
149	187	11.1	4	132	203	2	0.26	2.60	3.90	2.50	9.53
149	187	11.1	4	132	203	2	0.26	2.60	3.90	2.50	9.76
149	187	11.1	4	132	203	2	0.26	2.60	3.90	2.50	9.68
150	182	8.3	5	132	203	2	0.35	1.90	2.90	1.80	12.1
150	182	8.3	5	132	203	2	0.35	1.90	2.90	1.80	12.0
150	182	8.3	5	132	203	2	0.35	1.90	2.90	1.80	11.9
146	167			130	190	2	0.38	1.80	2.60	1.70	21.3
157	218			134	246	2.5					21.7
157	218			134	246	2.5					21.3
157	218			134	246	2.5					21.1
157	218			134	246	2.5					21.2

Spherical Roller Bearing(CA)

d 120~130 mm

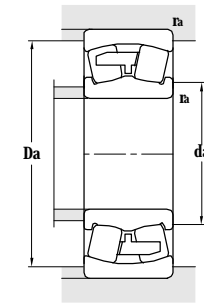
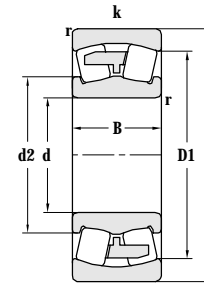
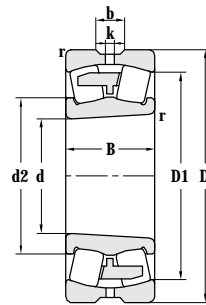
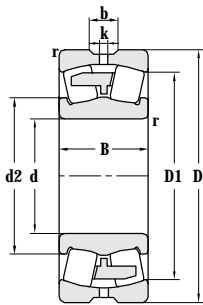

Principal dimensions				Basic load ratings		Limit speed ratings		Designations
d	D	B	r _{min}	C _r	C _{0r}	Grease	Oil	
mm				kN		r/min		
120	260	86	3	920	1100	1400	1800	22324CA 22324CA/W33
	260	86	3	920	1100	1400	1800	22324CAN/W33
	260	86	3	920	1100	1400	1800	22324CAF3 22324CAK
	260	86	3	920	1100	1400	1800	22324CAKF3 22324CAKF3/W33
	260	86	3	920	1100	1400	1800	22324ACA
130	200	52	2	410	580	1900	2600	23026CA 23026CA/W33
	200	52	2	410	580	1900	2600	23026CAF3 23026CAF3/W33
	200	52	2	410	580	1900	2600	23026CAK
	200	52	2	410	580	1900	2600	23026CAKF3 23026CAKF3/W33
	200	52	2	370	670	1900	2600	23026NR
	200	69	2	510	810	1800	2400	24026CA/W33 24026CA/W513
	200	69	2	510	820	1800	2400	24026F1/W33
	210	64	2	530	790	1700	2200	23126CA 23126CA/W33
	210	64	2	530	790	1700	2200	23126CAKF3/W33
	210	80	2	650	980	1700	2200	24126CA 24126CA/W33
	210	80	2	650	980	1700	2200	24126CAK/W33
	210	80	2	650	980	1700	2200	24126CAK30/W33
	220	73	3	740	1000	1700	2200	23226X3CAQ1/HG2P63
	230	64	3	700	880	1800	2400	22226CA 22226CA/W33
	230	64	3	700	880	1800	2400	22226CAK 22226CAK/W33
	230	64	3	700	880	1800	2400	22226CAKF3
	230	80	3	580	910	1400	1800	23226/W33
	230	80	3	740	1020	1300	1700	23226CA 23226CA/W33
	230	80	3	740	1020	1300	1700	23226CAF3 23226CAF3/W33
	230	80	3	740	1020	1300	1700	23226CAF3/HAC3SOW20X
	230	80	3	740	1020	1300	1700	23226CAK 23226CAKF3
	280	93	4	810	1250	1300	1700	22326 22326
	280	93	4	810	1250	1300	1700	22326K 22326K/W33
	280	93	4	810	1250	1300	1700	22326F3
	280	93	4	810	1250	1300	1700	22326KF3
	280	93	4	1060	1300	1300	1700	22326CA 22326CA/W33
	280	93	4	1060	1300	1300	1700	22326CAF3 22326CAF3/W33
	280	93	4	1060	1300	1300	1700	22326CAK 22326CAK/W33
280	93	4	1060	1300	1300	1700	22326ACA	
280	93	4	1060	1300	1300	1700	22326CAQ1/HA	

Other dimensions				Contact surface and chamfer dimensions			Calculation coefficient				Weight
d2	D1	b	k	da	Da	ra	e	Y1	Y2	Y0	
mm				mm	mm	mm	mm				kg
165	215	13.9	6	134	246	2.5	0.34	1.99	2.96	1.94	23.3
165	215	13.9	6	134	246	2.5	0.34	1.99	2.96	1.94	23.1
165	215			134	246	2.5	0.34	1.99	2.96	1.94	23.1
165	215	13.9	6	134	246	2.5	0.34	1.99	2.96	1.94	22.8
165	215			134	246	2.5	0.34	1.99	2.96	1.94	22.8
153	179	9.5	4	140	190	2	0.24	2.80	4.20	2.80	7.04
153	179	9.5	4	140	190	2	0.24	2.80	4.20	2.80	6.75
153	179			140	190	2	0.24	2.80	4.20	2.80	6.68
153	179	9.5	4	140	190	2	0.24	2.80	4.20	2.80	6.57
153	176			140	190	2					6.38
151	175	5.5	3	140	190	2	0.32	2.09	3.11	2.04	7.76
151	175	5.5	3	140	190	2					7.72
156	183	8.3	4	140	200	2	0.28	2.40	3.50	2.50	10.7
156	183	8.3	4	140	200	2	0.28	2.40	3.50	2.50	10.1
153	180	8.3	4	140	200	2	0.35	1.90	2.90	1.80	10.6
153	180	8.3	4	140	200	2	0.35	1.90	2.90	1.80	10.2
153	180	8.3	4	140	200	2	0.35	1.90	2.90	1.80	10.4
157	188			140	210	2	0.32	2.09	3.11	2.04	11.3
162	200	10	5	144	216	2.5	0.27	2.50	3.70	2.50	12.4
162	200	10	5	144	216	2.5	0.27	2.50	3.70	2.50	12.2
162	200			144	216	2.5	0.27	2.50	3.70	2.50	12.1
164	194	12	5	144	216	2.5	0.34	1.99	2.96	1.94	14.9
161	194	12	5	144	216	2.5	0.33	2.00	3.00	2.00	15.9
161	194	12	5	144	216	2.5	0.33	2.00	3.00	2.00	15.8
161	194	12	5	144	216	2.5	0.33	2.00	3.00	2.00	15.8
161	194			144	216	2.5	0.33	2.00	3.00	2.00	15.9
176	235	16.7	6	148	262	3					27.2
176	235	16.7	6	148	262	3					26.6
176	235			148	262	3					27.1
176	235			148	262	3					26.5
178	232	16.7	6	148	262	3	0.34	1.99	2.96	1.94	28.9
178	232	16.7	6	148	262	3	0.34	1.99	2.96	1.94	28.4
178	232	16.7	6	148	262	3	0.34	1.99	2.96	1.94	26.3
178	232			148	262	3	0.34	1.99	2.96	1.94	28.9
178	232			148	262	3	0.34	1.99	2.96	1.94	28.9

Spherical Roller Bearing(CA)

d 140~150 mm

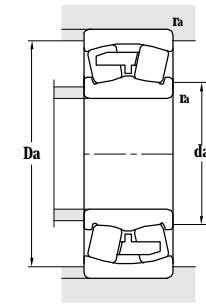
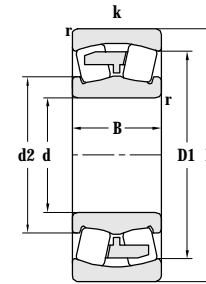
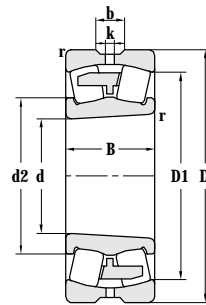
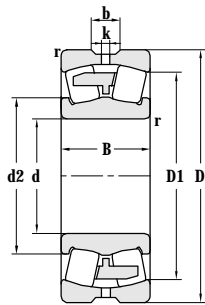

Principal dimensions				Basic load ratings		Limit speed ratings		Designations
d	D	B	r _{min}	C _r	C _{Or}	Grease	Oil	
mm				kN		r/min		
140	210	53	2	440	655	1800	2400	23028 23028/W33
	210	53	2	440	655	1800	2400	23028K 23028K/W33
	210	53	2	440	655	1800	2400	23028F3 23028F3/W33
	210	53	2	440	655	1800	2400	23028KF3 23028KF3/W33
	210	53	2	440	706	1800	2400	23028CA 23028CA/W33
	210	53	2	440	706	1800	2400	23028CAF3
	210	53	2	440	706	1800	2400	23028CAK 23028CAKF3
	210	69	2	540	960	1800	2400	24028CA 24028CA/W33
	210	69	2	540	960	1800	2400	24028CAK30/W33
	211.5	69	2	540	960	1800	2400	24028CAX1/W33
	225	68	2.1	550	865	1600	2000	23128 23128/W33
	225	68	2.1	550	865	1600	2000	23128K 23128K/W33
	225	68	2.1	550	865	1600	2000	23128F3
	225	68	2.1	550	865	1600	2000	23128KF3
	225	68	2.1	550	865	1600	2000	23128N
	225	68	2.1	600	935	1600	2000	23128CA 23128CA/W33
	225	68	2.1	600	935	1600	2000	23128CAN
	225	85	2.1	730	1150	850	1100	24128CA 24128CA/W33
	225	85	2.1	730	1150	850	1100	24128CAF3
	225	85	2.1	730	1150	850	1100	24128CAK30/W33
	250	68	3	680	1000	1700	2200	22228CA 22228CA/W33
	250	68	3	680	1000	1700	2200	22228CAF3 22228CAF3/W33
	250	68	3	680	1000	1700	2200	22228CAK 22228CAK/W33
	250	68	3	680	1000	1700	2200	22228CAKF3/W33
	250	88	3	770	1095	1300	1700	23228K/W33
	250	88	3	910	1365	1200	1600	23228CA/W33 23228CAF3/W33
	250	88	3	910	1365	1200	1600	23228CAK/W33
	300	102	4	1230	1950	1100	1500	22328CA 22328CA/W33
	300	102	4	1230	1950	1100	1500	22328CAF3 22328CAQ1/HA
	300	102	4	1230	1950	1100	1500	22328CAK 22328CAK/W33
	300	102	4	1230	1950	1100	1500	22328CAN/W33
	300	102	4	1230	1950	1100	1500	22328CAQ1/HA
300	118	4	1230	1950	1100	1500	23328CA	
150	225	56	2.1	485	795	1700	2200	23030CA 23030CA/W33
	225	56	2.1	485	795	1700	2200	23030CAK

Other dimensions				Contact surface and chamfer dimensions			Calculation coefficient				Weight
d2	D1	b	k	da	Da	ra	e	Y1	Y2	Y0	
mm				mm	mm	mm	mm				kg
162	187	8.3	4	150	200	2					6.8
162	187	8.3	4	150	200	2					6.36
162	187	8.3	4	150	200	2					6.73
162	187	8.3	4	150	200	2					6.29
162	188	8.3	4.5	150	200	2	0.23	2.90	4.40	2.80	6.70
162	188			150	200	2	0.23	2.90	4.40	2.80	6.68
162	188			150	200	2	0.23	2.90	4.40	2.80	6.50
162	185	5.5	3	150	200	2	0.30	2.30	3.40	2.20	8.31
162	185	5.5	3	150	200	2	0.30	2.30	3.40	2.20	8.17
162	183	5.5	3	150	200	2	0.30	2.30	3.40	2.20	8.58
166	196			152	213	2					10.9
166	196	8.3	5	152	213	2					10.9
166	196			152	213	2					10.8
166	196			152	213	2					10.7
166	196			152	213	2					10.9
166	196	8.3	5	152	213	2	0.29	2.30	3.50	2.40	10.9
166	196	8.3	5	152	213	2	0.29	2.30	3.50	2.40	10.9
165	192	8.3	4.5	152	213	2	0.37	1.80	2.70	1.80	13.5
165	192			152	213	2	0.37	1.80	2.70	1.80	13.5
165	192	8.3	4.5	152	213	2	0.37	1.80	2.70	1.80	13.2
176	218	11.1	5	154	236	2.5	0.26	2.60	3.90	2.50	16.2
176	218	11.1	5	154	236	2.5	0.26	2.60	3.90	2.50	15.6
176	218	11.1	5	154	236	2.5	0.26	2.60	3.90	2.50	15.0
176	218	11.1	5	154	236	2.5	0.26	2.60	3.90	2.50	14.8
172	215	15	6	154	236	2.5	0.36	1.87	2.79	1.83	18.3
173	215	15	6	154	236	2.5	0.33	2.00	3.00	2.00	19.7
173	215	15	6	154	236	2.5	0.33	2.00	3.00	2.00	19.3
191	249	16.7	7	158	282	3	0.35	1.90	2.90	1.80	36.0
191	249			158	282	3	0.35	1.90	2.90	1.80	35.9
191	249	16.7	7	158	282	3	0.35	1.90	2.90	1.80	36.2
191	249	16.7	7	158	282	3					36.0
191	249	16.7	7	158	282	3					36.2
190	243			158	280	3	0.40	1.69	2.51	1.65	41.7
174	201	8.3	4.5	162	213	2	0.22	3.00	4.60	2.80	8.01
174	201	8.3	4.5	162	213	2	0.22	3.00	4.60	2.80	7.41

Spherical Roller Bearing(CA)

d 150~160 mm

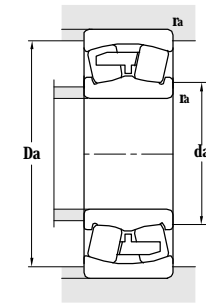
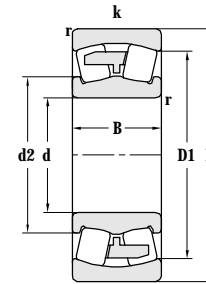
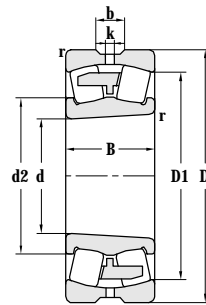
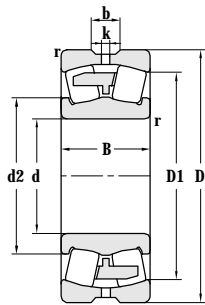

Principal dimensions				Basic load ratings		Limit speed ratings		Designations
d	D	B	r _{min}	C _r	C _{OR}	Grease	Oil	
mm				kN		r/min		
150	225	56	2.1	485	795	1700	2200	23030CAF3
	225	75	2.1	620	1050	1300	1700	24030CA/W33
	225	75	2.1	620	990	1300	1700	24030CA/W33X
	250	80	2.1	660	625	1400	1800	23130
	250	80	2.1	660	625	1400	1800	23130K
	250	80	2.1	660	625	1400	1800	23130F3
	250	80	2.1	660	625	1400	1800	23130KF3
	250	80	2.1	790	1140	1400	1800	23130CA
	250	80	2.1	790	1140	1400	1800	23130CAK
	250	80	2.1	790	1140	1400	1800	23130CAF3
	250	100	2.1	970	1450	800	1000	24130CA
	250	100	2.1	970	1450	800	1000	24130CAK30/C3W33
	270	73	3	810	1050	1600	2000	22230CA
	270	73	3	810	1050	1600	2000	22230CAF3
	270	73	3	810	1050	1600	2000	22230ACA
	270	96	3	1030	1550	1100	1500	23230CA
	270	96	3	1030	1550	1100	1500	23230CAK/W33
	270	96	3	1030	1550	1100	1500	23230CA/HCW33
	300	118	4	1780	1110			23328CA
	320	108	4	1390	1810	1000	1400	22330CA
	320	108	4	1390	1810	1000	1400	22330CA/HCW33
	320	108	4	1390	1810	1000	1400	22330CAK
	160	240	60	2.1	415	860	1700	2200
240		60	2.1	415	860	1700	2200	23032K
240		60	2.1	415	860	1700	2200	23032F3
240		60	2.1	415	860	1700	2200	23032KF3
240		60	2.1	555	875	1700	2200	23032CA
240		60	2.1	555	875	1700	2200	23032CAK/W33
240		60	2.1	555	875	1700	2200	23032CAF3
240		80	2.1	600	1020	1100	1500	24032K/W33
240		80	2.1	710	1210	1100	1500	24032CA/W33
240		80	2.1	710	1210	1100	1500	24032CAF3/W33
240		80	2.1	710	1210	1100	1500	24032CAK30F3
240		80	2.1	710	1210	1200	1600	24032K/W33
270		86	2.1	930	1300	1300	1700	23132
270		86	2.1	930	1300	1300	1700	23132K

Other dimensions				Contact surface and chamfer dimensions			Calculation coefficient				Weight	
d2	D1	b	k	da	Da	ra	e	Y1	Y2	Y0		
mm				mm	mm	mm	mm				kg	
174	201			162	213	2	0.22	3.00	4.60	2.80	7.96	
175	196	5.5	3	162	213	2	0.31	2.20	3.30	2.20	9.39	
175	196	5.5	3	162	213	2	0.31	2.20	3.30	2.20	9.39	
182	216	11.1	5	162	238	2					15.8	
182	216	11.1	5	162	238	2					16.1	
182	216	11.1	5	162	238	2					15.6	
182	216	11.1	5	162	238	2					15.9	
182	216	11.1	5	162	238	2	0.30	2.30	3.40	2.20	16.5	
182	216	11.1	5	162	238	2	0.30	2.30	3.40	2.20	16.4	
182	216	11.1	5	162	238	2	0.30	2.30	3.40	2.20	16.4	
180	208	8.3	4.5	162	238	2	0.37	1.80	2.70	1.80	19.2	
180	208	8.3	4.5	162	238	2	0.37	1.80	2.70	1.80	19.0	
189	234	12	6	164	256	2.5	0.26	2.60	3.90	2.50	18.7	
189	234			164	256	2.5	0.26	2.60	3.90	2.50	18.5	
189	234			164	256	2.5	0.26	2.60	3.90	2.50	18.2	
188	228	11.1	6	164	256	2.5	0.35	1.90	2.90	1.80	26.6	
188	228	11.1	6	164	256	2.5	0.35	1.90	2.90	1.80	26.3	
188	228	11.1	6	164	256	2.5	0.35	1.90	2.90	1.80	26.5	
190	243			168	275	3					41.7	
203	265	16.7	9	168	302	3	0.36	1.87	2.79	1.83	41.0	
203	265	16.7	9	168	302	3	0.36	1.87	2.79	1.83	40.6	
203	265			168	302	3	0.36	1.87	2.79	1.83	41.1	
160	185	213	11.1	4	172	228	2				10.2	
	185	213	11.1	4	172	228	2				9.89	
	185	213	11.1	4	172	228	2				10	
	185	213			172	228	2				9.7	
	186	216	8.3	5	172	228	2	0.22	3.00	4.60	2.80	10.0
	186	216	8.3	5	172	228	2	0.22	3.00	4.60	2.80	9.5
	186	216			172	228	2	0.22	3.00	4.60	2.80	9.97
	183	209	8.3	5	172	228	2					12.1
	183	209	8.3	5	172	228	2	0.30	2.30	3.40	2.20	13.2
	183	209	8.3	5	172	228	2	0.30	2.30	3.40	2.20	13.2
	184	209	8.3	5	172	228	2	0.32	2.09	3.11	2.04	12.1
	188	234	13.9	6	172	258	2					21.2
	188	234			172	258	2					20.6

Spherical Roller Bearing(CA)

d 160~170 mm

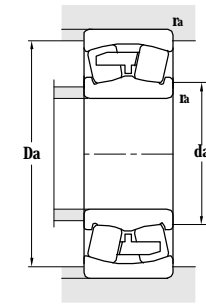
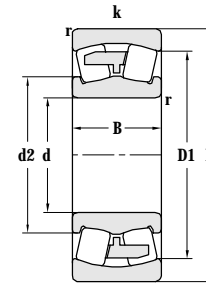
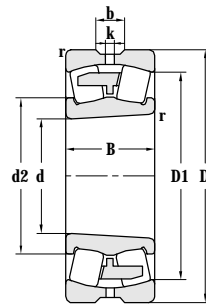
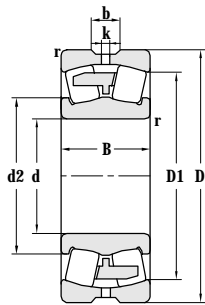

Principal dimensions				Basic load ratings		Limit speed ratings		Designations		
d	D	B	r _{min}	C _r	C _{OR}	Grease	Oil			
mm				kN		r/min				
160	270	86	2.1	930	1300	1300	1700	23132F3	23132F3/W33	
	270	86	2.1	930	1300	1300	1700	23132N		
	270	86	2.1	930	1430	1300	1700	23132CA	23132CA/W33	
	270	86	2.1	930	1430	1300	1700	23132CAK		
	270	86	2.1	930	1430	1300	1700	23132CAF3		
	270	86	2.1	685	1140	1400	1800	23132K		
	270	86	2.1	930	1300	1400	1800	23132CK	23132CK/W33	
	270	109	2.1	1120	1690	700	900	24132CA/HAC9SOW20X		
	270	109	2.1	1120	1690	700	900	24132CA/W33	24132CA/W33X	
	270	109	2.1	1120	1690	700	900	24132CAK30/C3W33		
	290	80	3	950	1380	1500	1900	22232CA	22232CAF3	
	290	80	3	950	1300	1500	1900	22232CAK		
	290	80	3	950	1300	1500	1900	22233ACA		
	290	104	3	900	1600	1000	1400	23232		
	290	104	3	900	1600	1000	1400	23232K		
	290	104	3	900	1600	1000	1400	23232F3		
	290	104	3	1160	1770	1000	1400	23232CA	23232CA/W33	
	290	104	3	1160	1770	1000	1400	23232CAK	23232CAK/W33	
	340	114	4	1200	1800	950	1300	22332	22332/W33	
	340	114	4	1200	1800	950	1300	22332K	22332K/W33	
	340	114	4	1200	1800	950	1300	22332F3		
	340	114	4	1200	1800	950	1300	22332KF3		
	340	114	4	1520	1860	950	1300	22332CAK		
	340	114	4	1520	2050	950	1300	22332CA	22332CA/W33	
	340	114	4	1520	2050	950	1300	22332CAF3	22332CAF3/W33	
	340	114	4	1520	2050	950	1300	22332CAK		
	340	114	4	1200	1800	950	1300	22332Q1/W33		
	340	114	4	1520	2050	950	1300	22332CAKF3/W33		
	170	230	45	2	310	715	1700	2200	23934CA/W33	
		260	67	2.1	510	1070	1600	2000	23034	23034/W33
		260	67	2.1	510	1070	1600	2000	23034K	23034K/W33
		260	67	2.1	510	1070	1600	2000	23034/YA2	
260		67	2.1	510	1070	1600	2000	23034F3		
260		67	2.1	510	1070	1600	2000	23034KF3		
260		67	2.1	670	1090	1600	2000	23034CA	23034CA/W33	

Other dimensions				Contact surface and chamfer dimensions			Calculation coefficient				Weight	
d2	D1	b	k	da	Da	ra	e	Y1	Y2	Y0		
mm				mm			mm				kg	
188	234			172	258	2						21
188	234			172	258	2						21
188	234	13.9	6	172	258	2	0.30	2.30	3.40	2.20		21.9
188	234			172	258	2	0.30	2.30	3.40	2.20		21.7
195	234			172	258	2	0.30	2.30	3.40	2.20		21.9
193	231			172	258	2	0.34	1.99	2.96	1.94		20.6
193	231	13.9	6	172	258	2	0.34	1.99	2.96	1.94		21.2
195	225	8.3	4	172	258	2	0.40	1.69	2.51	1.65		23.4
193	225	8.3	4	172	258	2	0.40	1.69	2.51	1.65		24.6
193	225	8.3	4	172	258	2	0.40	1.69	2.51	1.65		24.2
193	249			174	276	2.5	0.27	2.50	3.70	2.50		24.6
201	249			174	276	2.5	0.27	2.50	3.70	2.50		23.8
201	249			174	276	2.5	0.27	2.50	3.70	2.50		24.1
198	244			174	276	2.5						36.1
198	244			174	276	2.5						34.3
198	244			174	276	2.5						35.9
189	244	13.9	7	174	276	2.5	0.35	1.90	2.90	1.80		30.2
200	244	13.9	7	174	276	2.5	0.35	1.90	2.90	1.80		28.9
212	283	16.7	7	178	322	3						50.2
212	283	16.7	7	178	322	3						49.5
212	283			178	322	3						49.7
212	283			178	322	3						49
201	284			178	322	3	0.35	1.90	2.90	1.80		52.8
201	284	16.7	7	178	322	3	0.35	1.90	2.90	1.80		51.6
216	284	16.7	7	178	322	3	0.35	1.90	2.90	1.80		51.8
201	284	16.7	7	178	322	3	0.35	1.90	2.90	1.80		51.6
212	283	16.7	7	178	322	3						50.2
216	284	16.7	7	178	322	3	0.35	1.90	2.90	1.80		51.8
189	212	5.5	3	182	213	2						5.45
200	231	11.1	5	182	248	2						13.7
200	231	11.1	5	182	248	2						13.3
200	231			182	248	2						13.6
200	231			182	248	2						13.6
200	231			182	248	2						13.2
198	231	11.1	5	182	248	2	0.23	2.90	4.40	2.80		14.1

Spherical Roller Bearing(CA)

d 170~180 mm

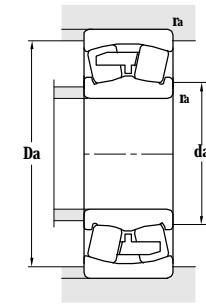
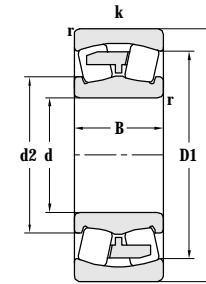
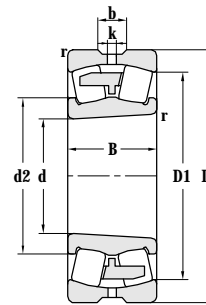
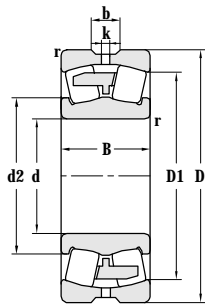

Principal dimensions				Basic load ratings		Limit speed ratings		Designations	
d	D	B	r _{min}	C _r	C _{0r}	Grease	Oil		
mm				kN		r/min			
170	260	67	2.1	670	1090	1600	2000	23034CAK	
	260	67	2.1	670	1090	1600	2000	23034CAF3	
	260	67	2.1	670	1090	1600	2000	23034CAKF3/W33	
	260	90	2.1	885	1500	1000	1400	24034CA	
	260	90	2.1	885	1500	1000	1400	24034CAK/W33	
	280	88	2.1	890	1450	1200	1600	23134	
	280	88	2.1	890	1450	1200	1600	23134K	
	280	88	2.1	890	1450	1200	1600	23134F3	
	280	88	2.1	890	1450	1200	1600	23134KF3	
	280	88	2.1	990	1530	1200	1600	23134CA	
	280	88	2.1	990	1530	1200	1600	23134CAK	
	280	109	2.1	1160	1830	670	850	24134CA	
	280	109	2.1	1160	1830	670	850	24134CAK30/W33	
	280	88	2.1	990	1530	1200	1600	23134CAKF3	
	280	109	2.1	1160	1770	670	850	24134CA/W33	
	280	109	2.1	1160	1770	670	850	24134CA	
	310	86	4	1060	1450	1300	1700	22234CA	
	310	86	4	1060	1450	1300	1700	22234CAK	
	310	86	4	1060	1390	1300	1700	22234K/W33	
	310	110	4	1330	1930	950	1300	23234CA	
	310	110	4	1330	1930	950	1300	23234CAF3/W33	
	360	120	4	1300	2110	950	1300	22334	
	360	120	4	1300	2110	950	1300	22334K	
	360	120	4	1300	2110	950	1300	22334KF3	
	360	120	4	1300	2110	950	1300	22334F3	
	360	120	4	1670	2120	950	1300	22334CA/W33	
	360	120	4	1670	2120	950	1300	22334CA/W33X	
	360	120	4	1670	2120	950	1300	22334ACA	
	360	120	4	1670	2120	950	1300	22334CA/HCEW33	
	360	136	4	1670	2280	950	1300	23334X2/W33	
	180	250	52	2	430	830	1700	2200	23936CAF3/W33
		280	74	2.1	700	1320	1400	1800	23036
280		74	2.1	700	1320	1400	1800	23036K	
280		74	2.1	700	1320	1400	1800	23036YA2	
280		74	2.1	700	1320	1400	1800	23036F3	
250		52	2	430	830	1700	2200	23936CA/W33	
280		74	2.1	700	1320	1400	1800	23036/W33	
280		74	2.1	700	1320	1400	1800	23036K/W33	

Other dimensions				Contact surface and chamfer dimensions			Calculation coefficient				Weight
d2	D1	b	k	da	Da	ra	e	Y1	Y2	Y0	
mm				mm	mm	mm	mm				kg
198	231			182	248	2	0.23	2.90	4.40	2.80	13.8
198	231			182	248	2	0.23	2.90	4.40	2.80	14.0
198	231	11.1	5	182	248	2	0.23	2.90	4.40	2.80	13.5
198	227	8.3	4	182	248	2	0.33	2.00	3.00	2.00	17.8
188	226	8.3	4	198	249	2	0.33	2.00	3.00	2.00	16.8
204	246	13.9	6	182	268	2					23
204	246	13.9	6	182	268	2					21.6
204	246			182	268	2					22.6
204	246			182	268	2					21.2
204	243			182	268	2	0.30	2.30	3.40	2.20	25.7
204	243	13.9	6	182	268	2	0.30	2.30	3.40	2.20	24.3
203	237	8.3	5	182	268	2	0.37	1.80	2.70	1.80	25.4
203	237	8.3	5	182	268	2	0.37	1.80	2.70	1.80	24.7
204	243			182	268	2	0.30	2.30	3.40	2.20	24.6
203	237	8.3	5	182	268	2	0.37	1.80	2.70	1.80	24.8
203	237	8.3	5	182	268	2	0.37	1.80	2.70	1.80	25.4
215	268	16.7	6	188	292	3	0.27	2.50	3.70	2.50	26.8
215	268	16.7	6	188	292	3	0.27	2.50	3.70	2.50	26.2
215	268	16.7	6	188	292	3	0.27	2.50	3.70	2.50	27.8
214	261	13.9	7	188	292	3	0.34	1.99	2.96	1.94	38.0
214	261	13.9	7	188	292	3	0.34	1.99	2.96	1.94	37.7
228	300	16.7	7	188	342	3					60.1
228	300	16.7	7	188	342	3					60.1
228	300			188	342	3					59.4
228	300			188	342	3					60
231	299	16.7	7	188	342	3	0.34	1.99	2.96	1.94	62.6
231	299	16.7	7	188	342	3	0.34	1.99	2.96	1.94	62.6
231	299			188	342	3	0.34	1.99	2.96	1.94	61.4
231	299	16.7	7	188	342	3	0.34	1.99	2.96	1.94	62.6
229	292	22.3	12	188	342	3					68.6
204	230	9.5	4	190	240	2	0.18	3.80	5.60	3.60	7.4
214	247	13.9	6	192	268	2					18.1
214	247	13.9	6	192	268	2					17.6
214	247			192	268	2					18
214	247			192	268	2					17.6

Spherical Roller Bearing(CA)

d 180 mm

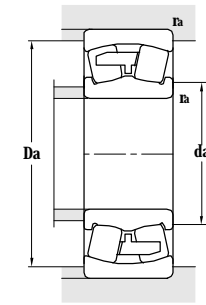
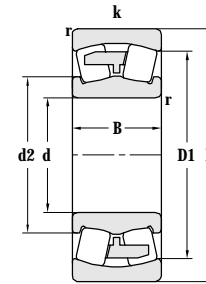
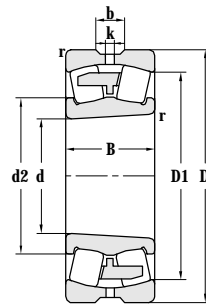
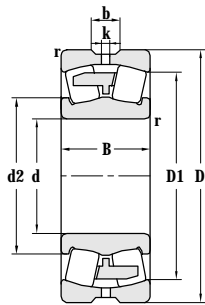

Principal dimensions				Basic load ratings		Limit speed ratings		Designations
d	D	B	r _{min}	C _r	C _{0r}	Grease	Oil	
mm				kN		r/min		
180	280	74	2.1	700	1320	1400	1800	23036KF3
	280	74	2.1	790	1280	1400	1800	23036CA
	280	74	2.1	790	1280	1400	1800	23036CA/W33
	280	74	2.1	790	1280	1400	1800	23036CAK/W33
	280	100	2.1	1030	1750	950	1300	23036CAF3
	280	100	2.1	1030	1750	950	1300	24036CA/W33
	280	100	2.1	1030	1750	950	1300	24036CAF3/W33
	280	100	2.1	1030	1750	950	1300	24036CAK30F3/W33
	300	96	3	1140	1670	1100	1500	23136
	300	96	3	1140	1670	1100	1500	23136K
	300	96	3	1140	1670	1100	1500	23136K/W33
	300	96	3	1140	1670	1100	1500	23136F3
	300	96	3	1140	1670	1100	1500	23136KF3
	300	96	3	1140	1800	1100	1500	23136CA
	300	96	3	1140	1800	1100	1500	23136CA/W33
	300	96	3	1140	1800	1100	1500	23136CAF3
	300	96	3	1140	1800	1100	1500	23136CAK
	300	96	3	1140	1800	1100	1500	23136CAK/W33
	300	96	3	1140	1800	1100	1500	23136CAK30/W33
	300	96	3	1140	1800	1100	1500	23136CAK/W33
	300	118	3	1330	2050	630	800	24136CA
	300	118	3	1330	2050	630	800	24136CA/W33
	300	118	3	1330	2050	630	800	24136CA/HCW33YA2
	300	118	3	1330	2050	630	800	24136CAQ1
	320	86	4	1120	1550	1300	1700	22236
	320	86	4	1120	1550	1300	1700	22236K
	320	86	4	1120	1550	1300	1700	22236KF3
	320	86	4	1120	1550	1300	1700	22236F3
	320	86	4	1120	1550	1300	1700	22236F3/W33
	320	86	4	1120	1550	1300	1700	22236CA
	320	86	4	1120	1550	1300	1700	22236CA/W33
	320	86	4	1120	1550	1300	1700	22236CAF3
	320	86	4	1120	1550	1300	1700	22236CAQ1
	320	86	4	1120	1550	1300	1700	22236CAK
	320	86	4	1120	1550	1300	1700	22236CAK/W33
	320	86	4	1120	1550	1300	1700	22236CAK/W33T
	320	112	4	1290	2270	900	1200	23236/W33
	320	112	4	1430	2130	900	1200	23236CA
	320	112	4	1430	2130	900	1200	23236CA/W33
	320	112	4	1430	2130	900	1200	23236CA/HCW33
320	112	4	1430	2130	900	1200	23236CA/W33	
320	112	4	1430	2130	900	1200	23236CAF3	
320	112	4	1430	2130	900	1200	23236CAF3/W33	
320	112	4	1430	2130	900	1200	23236CAK/W33	
320	112	4	1430	2130	900	1200	23236CAK/W33	
380	126	4	1400	2300	900	1200	22336	
380	126	4	1400	2300	900	1200	22336K	
380	126	4	1400	2300	900	1200	22336K/W33	
380	126	4	1400	2300	900	1200	22336F3	
380	126	4	1900	2400	900	1200	22336CA	
380	126	4	1900	2400	900	1200	22336CA/W33	
380	126	4	1900	2400	900	1200	22336CAF3/W33	
380	126	4	1900	2400	900	1200	22336CAK	
380	126	4	1900	2400	900	1200	22336CAK/W33	

Other dimensions				Contact surface and chamfer dimensions			Calculation coefficient				Weight
d2	D1	b	k	da	Da	ra	e	Y1	Y2	Y0	
mm				mm			mm				kg
214	247			192	268	2					17.2
214	247	13.9	7.5	192	268	2	0.25	2.70	4.00	2.60	17.7
214	247	13.9	7.5	192	268	2	0.25	2.70	4.00	2.60	16.8
214	247			192	268	2	0.25	2.70	4.00	2.60	17.6
210	242	8.3	4	192	268	2	0.33	2.00	3.00	2.00	25.7
210	242	8.3	4	192	268	2	0.33	2.00	3.00	2.00	25.6
216	259			194	286	2.5					28.6
216	259	13.9	6	194	286	2.5					28.2
216	259			194	286	2.5					28.2
216	259	13.9	6	194	286	2.5					27.8
216	259	13.9	6	194	286	2.5	0.30	2.30	3.40	2.20	27.6
216	259			194	286	2.5	0.30	2.30	3.40	2.20	27.0
216	259	13.9	6	194	286	2.5	0.30	2.30	3.40	2.20	27.5
216	259			194	286	2.5					26.8
216	259	13.9	6	194	286	2.5	0.30	2.30	3.40	2.20	26.5
212	252	11.1	6	194	286	2.5	0.37	1.80	2.70	1.80	33.0
212	252	11.1	6	194	286	2.5	0.37	1.80	2.70	1.80	32.8
212	252			194	286	2.5	0.37	1.80	2.70	1.80	33.0
224	278			198	302	3					31.1
224	278			198	302	3					30.2
224	278			198	302	3					30.8
224	278	16.7	6	198	302	3	0.26	2.60	3.90	2.50	29.4
224	278			198	302	3	0.26	2.60	3.90	2.50	29.2
224	278			198	302	3	0.26	2.60	3.90	2.50	29.3
224	278	16.7	6	198	302	3	0.26	2.60	3.90	2.50	29.1
222	271	13.9	7	198	302	3					40
222	271			198	302	3	0.35	1.90	2.90	1.80	38.7
222	271	13.9	7	198	302	3	0.35	1.90	2.90	1.80	38.6
222	271	13.9	7	198	302	3	0.35	1.90	2.90	1.80	38.5
222	271	13.9	7	198	302	3	0.35	1.90	2.90	1.80	38.4
241	317	22.3	8	198	362	3					70.9
241	317	22.3	8	198	362	3					69.8
241	317			198	362	3					70.5
242	316	22.3	8	198	362	3	0.34	1.99	2.96	1.94	72.2
242	316	22.3	8	198	362	3	0.34	1.99	2.96	1.94	71.3
242	316	22.3	8	198	362	3	0.34	1.99	2.96	1.94	71.3

Spherical Roller Bearing (CA)

d 190~200 mm

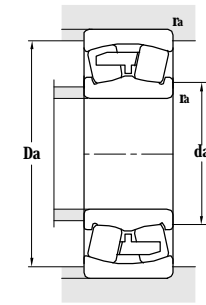
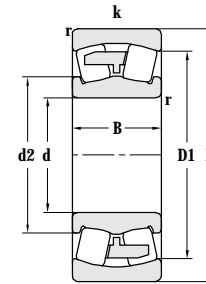
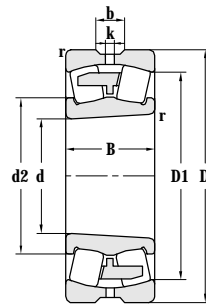
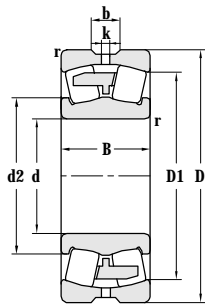

Principal dimensions				Basic load ratings		Limit speed ratings		Designations
d	D	B	r _{min}	C _r	C _{OR}	Grease	Oil	
mm				kN		r/min		
190	260	52	2	440	855	1600	2000	23938CA/W33
	280	67	2.5	660	1210			20638
	290	75	2.1	720	1300	1300	1700	23038
	290	75	2.1	720	1300	1300	1700	23038K
	290	75	2.1	720	1300	1300	1700	23038F3
	290	75	2.1	820	1450	1300	1700	23038CA
	290	75	2.1	820	1450	1300	1700	23038CAF3
	290	75	2.1	820	1450	1300	1700	23038CAK
	290	75	2.1	820	1450	1300	1700	23038CAKF3/W33
	290	100	2.1	1060	1840	950	1300	24038CA
	290	100	2.1	1060	1840	950	1300	24038CAF3
	290	100	2.1	1060	1840	950	1300	24038CA/W33X
	320	104	3	1100	1880	1000	1400	23138
	320	104	3	1100	1880	1000	1400	23138K
	320	104	3	1100	1880	1000	1400	23138F3
	320	104	3	1100	1880	1000	1400	23138KF3
	320	104	3	1300	1980	1000	1400	23138CA
	320	104	3	1300	1980	1000	1400	23138CAK/W33
	320	128	3	1520	2400	600	750	24138CA
	320	128	3	1520	2400	600	750	24138CAF3
	320	128	3	1520	2400	600	750	24138CA/HCW33
	320	128	3	1520	2400	600	750	24138CAK30F3/W33
	340	92	4	1210	1620	1200	1600	22238F3
	340	92	4	1210	1620	1200	1600	22238CA
	340	92	4	1210	1620	1200	1600	22238CA/W33
	340	92	4	1210	1620	1200	1600	22238CAKF3
	340	92	4	1210	1620	1200	1600	22238CAK
	340	92	4	1210	1620	1200	1600	22238CAK/W33
	340	92	4	1210	1620	1200	1600	22238ACA
	340	120	4	1580	2400	850	1100	23238CA
	340	120	4	1580	2400	850	1100	23238CAK/W33
	400	132	5	2010	2630	850	1100	22338CA
	400	132	5	2010	2630	850	1100	22338CAF3
	400	132	5	2010	2630	850	1100	22338ACA
200	280	60	2.1	520	1150	1600	2000	23940CAF3/W33
	280	186	1.1					23940CA/W33
								H2344

Other dimensions				Contact surface and chamfer dimensions			Calculation coefficient				Weight
d2	D1	b	k	da	Da	ra	e	Y1	Y2	Y0	
mm				mm	mm	mm	mm				
213	238	5.5	3	202	248	2	0.18	3.80	5.60	3.60	8.29
220	253			204	264	2					14.5
222	259	13.9	5	202	278	2					19.6
222	259	13.9	5	202	278	2					19.1
222	259	13.9	5	202	278	2					19.4
224	259	13.9	5	202	278	2	0.23	2.90	4.40	2.80	17.3
224	259			202	278	2	0.23	2.90	4.40	2.80	17.2
224	259	13.9	5	202	278	2	0.23	2.90	4.40	2.80	16.8
224	259	13.9	5	202	278	2	0.23	2.90	4.40	2.80	16.5
219	252	8.3	4.5	202	278	2	0.31	2.20	3.30	2.20	22.9
219	252			202	278	2	0.31	2.20	3.30	2.20	22.8
219	252	8.3	4.5	202	278	2	0.31	2.20	3.30	2.20	22.4
232	271			204	306	2.5					35.3
232	271	13.9	7	204	306	2.5					35.3
232	271			204	306	2.5					34.9
232	271			204	306	2.5					34.9
232	276	13.9	7	204	306	2.5	0.31	2.20	3.30	2.20	34.3
232	276	13.9	7	204	306	2.5					30
226	267	11.1	6	204	306	2.5	0.40	1.69	2.51	1.65	41.9
226	267	11.1	6	204	306	2.5	0.40	1.69	2.51	1.65	41.8
226	267	11.1	6	204	306	2.5	0.40	1.69	2.51	1.65	41.8
226	267	11.1	6	204	306	2.5	0.40	1.69	2.51	1.65	41.5
235	293			208	322	3					35.6
235	293			208	322	3	0.26	2.60	3.90	2.50	37.4
235	293	16.7	6	208	322	3	0.26	2.60	3.90	2.50	37.4
235	293			208	322	3	0.26	2.60	3.90	2.50	37.2
235	293	16.7	6	208	322	3	0.26	2.60	3.90	2.50	37.3
235	293			208	322	3	0.26	2.60	3.90	2.50	37.0
237	288	16.7	7	208	322	3	0.35	1.90	2.90	1.80	44.8
237	288	16.7	7	208	322	3	0.35	1.90	2.90	1.80	43.1
257	334	22.3	8	212	378	4	0.34	1.99	2.96	1.94	82.2
257	334			212	378	4	0.34	1.99	2.96	1.94	81.7
257	334	22.3	12	212	378	4	0.34	1.99	2.96	1.94	81.0
226	254	9.5	4	212	268	2	0.19	3.61	5.38	3.53	12.1
											16.8

Spherical Roller Bearing(CA)

d 200~220 mm

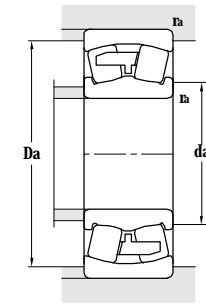
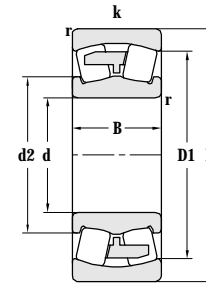
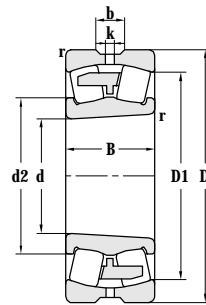
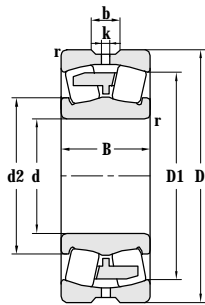

Principal dimensions				Basic load ratings		Limit speed ratings		Designations	
d	D	B	r _{min}	C _r	C _{0r}	Grease	Oil		
mm				kN		r/min			
200	310	82	2.1	660	1370	1200	1600	23040	23040/W33
	310	82	2.1	660	1370	1200	1600	23040K	23040K/W33
	310	82	2.1	660	1370	1200	1600	23040F3	23040F3/W33
	310	82	2.1	660	1370	1200	1600	23040KF3	
	310	82	2.1	950	1560	1200	1600	23040CA	23040CA/W33
	310	82	2.1	950	1560	1200	1600	23040CAK	23040CAK/W33
	310	109	2.1	1230	2130	900	1200	24040CA/W33	24040CAK30/W33
	340	112	3	1520	2240	950	1300	23140CA	23140CA/W33
	340	112	3	1520	2240	950	1300	23140CA/HCW33YA2	
	340	112	3	1520	2240	950	1300	23140CAK	23140CAK/W33
	340	140	3	1710	3800	5601	700	24140CA/W33	
	340	140	3	1710	3800	5601	700	24140CAK30F3	24140CAK30F3/W33
	360	98	4	1390	1830	1100	1500	22240	22240/W33
	360	98	4	1390	1830	1100	1500	22240K	22240K/W33
	360	98	4	1390	1830	1100	1500	22240F3	22240KF3/W33
	360	98	4	1390	1950	1100	1500	22240CA	22240CA/W33
	360	98	4	1390	1950	1100	1500	22240CAF3	22240CAKF3
	360	98	4	1390	1950	1100	1500	22240CAK	22240CAK/W33
	360	128	4	1770	2570	850	1100	23240CA/W33	
	360	128	4	1770	2570	850	1100	23240CA/HCW33	
	360	128	4	1770	2570	850	1100	23240CAK	23240CAK/W33
	360	128	4	1770	2730	900	1200	23240/W33	
	420	138	5	2200	2760	850	1100	22340	22340/W33
	420	138	5	2200	2760	850	1100	22340K	22340K/W33
	420	138	5	1620	2740	850	1100	22340F3	22340F3/W33
	420	138	5	2200	2860	850	1100	22340CA	22340CAF3
	420	138	5	2200	2860	850	1100	22340CA/W33	
	420	138	5	2200	2860	850	1100	22340CAK	22340CAK/W33
420	138	5	2000	2860	850	1100	22340CK	22340CK/W33	
420	165	5	2220	2860	750	950	23340CAF3		
220	300	60	2.1	520	1190	1500	1900	23944CA/W33	23944CAF3/C3W33
	340	90	3	1160	1900	1100	1500	23044CA	23044CA/W33
	340	90	3	1160	1900	1100	1500	23044CAK	23044CAK/W33
	340	90	3	1160	1900	1100	1500	23044CA/YA2	
	340	90	3	1160	1900	1100	1500	23044CAK/F3	
	340	90	3	1160	1900	1100	1500		

Other dimensions				Contact surface and chamfer dimensions			Calculation coefficient				Weight
d2	D1	b	k	da	Da	ra	e	Y1	Y2	Y0	
mm				mm	mm	mm	mm				kg
236	271	13.9	6	212	298	2					25
236	271	13.9	6	212	298	2					24.5
236	271	13.9	6	212	298	2					24.7
236	271	13.9	6	212	298	2					24.2
237	276	13.9	7.5	212	298	2	0.25	2.70	4.00	2.60	22.6
237	276	13.9	7.5	212	298	2	0.25	2.70	4.00	2.60	22.4
233	268	11.1	5	212	298	2	0.33	2.00	3.00	2.00	31.3
243	292	16.7	7	214	326	2.5	0.31	2.20	3.30	2.20	43.8
243	292	16.7	7	214	326	2.5	0.31	2.20	3.30	2.20	43.5
243	292	16.7	7	214	326	2.5	0.31	2.20	3.30	2.20	42.6
242	284	11.1	6	214	326	2.5	0.40	1.70	2.50	1.60	51.5
242	283	11.1	6	214	326	2.5	0.40	1.70	2.50	1.60	51.3
248	309			218	342	3					44.2
248	309			218	342	3					43.4
248	309			218	342	3					43.8
250	309	16.7	6	218	342	3	0.26	2.60	3.90	2.50	44.7
250	309	16.7	6	218	342	3	0.26	2.60	3.90	2.50	44.3
250	309	16.7	6	218	342	3	0.26	2.60	3.90	2.50	44
249	304	16.7	8	218	342	3	0.35	1.90	2.90	1.80	53.4
249	304	16.7	8	218	342	3	0.35	1.90	2.90	1.80	53.4
249	304	16.7	8	218	342	3	0.35	1.90	2.90	1.80	52
248	304	16.7	8	218	342	3	0.36	1.87	2.79	1.83	56.5
269	350	22.3	8	222	398	4					96
269	350	22.3	8	222	398	4					94
269	350	22.3	8	222	398	4					95
269	350	22.3	8	222	398	4	0.34	1.99	2.96	1.94	95.7
269	350	22.3	8	222	398	4	0.34	1.99	2.96	1.94	96.7
269	350	22.3	8	222	398	4	0.34	1.99	2.96	1.94	94
269	350	22.3	8	222	398	4	0.34	1.99	2.96	1.94	90
266	340			222	398	4	0.40	1.68	2.50	1.64	95.2
242	278	8.3	4	232	288	2	0.18	3.80	5.60	3.60	12.9
260	303	13.9	6	234	326	2.5	0.24	2.80	4.20	2.80	30.3
260	303	13.9	6	234	326	2.5	0.24	2.80	4.20	2.80	31.6
260	303			234	326	2.5	0.25	2.75	4.09	2.69	31.5
260	303			234	326	2.5	0.24	2.80	4.20	2.80	31

Spherical Roller Bearing(CA)

d 220~240 mm

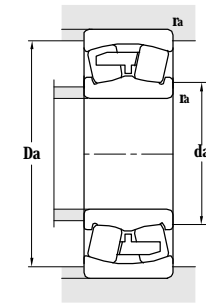
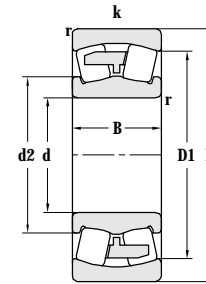
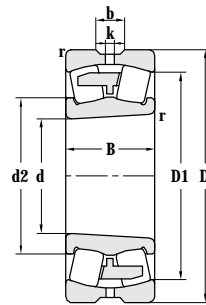
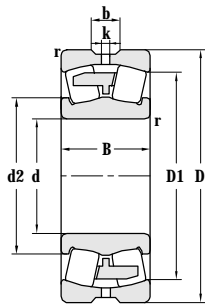

Principal dimensions				Basic load ratings		Limit speed ratings		Designations
d	D	B	r _{min}	C _r	C _{0r}	Grease	Oil	
mm				kN		r/min		
220	340	118	3	1480	2500	850	1100	24044CA 24044CA/W33
	340	118	3	1480	2500	850	1100	24044CA/W33X
	340	118	3	1480	2500	850	1100	24044CAN
	340	118	3	1480	2500	850	1100	24044CAK30/W33
	340	118	3	1480	2500	850	1100	24044CAF3 24044CAF3/W33
	370	120	4	1500	1160	900	1200	23144 23144/W33
	370	120	4	1500	1160	900	1200	23144K
	370	120	4	1500	1160	900	1200	23144F3 23144F3/W33
	370	120	4	1500	1160	900	1200	23144KF3/W33
	370	120	4	1710	2710	900	1200	23144CA 23144CA/W33
	370	120	4	1510	2750	900	1200	23144CA/HG2W33
	370	120	4	1510	2710	900	1200	23144CAK 23144CAK/W33
	370	120	4	1730	2710	900	1200	23144CAKF3/W33 22244CAK/W33
	370	150	4	2010	3410	500	630	24144CA/W33 24144CAK30
	400	108	4	1670	2400	950	1300	22244CA 22244CA/W33
	400	108	4	1670	2400	950	1300	22244CA/W33X 22244CAF3
	400	108	4	1670	2400	950	1300	22244CAK 22244CAK/W33T
	400	144	4	2240	3280	750	950	23244CA/W33 23244CAK/W33
	460	145	5	2570	3450	980	1360	22344CA 22344CA/W33
	460	145	5	2570	3450	980	1360	22344CAK/W33
240	320	60	2.1	630	1360	1300	1700	23948CA 23948CA/W33
	320	60	2.1	660	1450	1300	1700	23948CAF3 23948CAF3/W33
	330	60	2.1	610	1280	1200	1500	23948X1CAF3/HA
	330	190	1.1					OH3152H
	360	92	3	1230	2110	1000	1400	23048 23048/W33
	360	92	3	1230	2110	1000	1400	23048Q1/YA2
	360	92	3	1230	2110	1000	1400	23048K 23048K/W33
	360	92	3	1230	2110	1000	1400	23048F3 23048F3/W33
	360	92	3	1230	2110	1000	1400	23048KF3 23048KF3/W33
	360	92	3	1230	2080	1000	1400	23048CA 23048CA/W33
	360	92	3	1230	2080	1000	1400	23048CAQ1/YA2
	360	92	3	1230	2080	1000	1400	23048CAK 23048CAK/W33
	360	92	3	1230	2080	1000	1400	23048CAQ1
	360	118	3	1520	2800	800	1000	24048CA
	360	118	3	1520	2800	800	1000	24048CA/W33X

Other dimensions				Contact surface and chamfer dimensions			Calculation coefficient				Weight
d2	D1	b	k	da	Da	ra	e	Y1	Y2	Y0	
mm				mm	mm	mm	mm				kg
257	295	11.1	5	234	326	2.5	0.33	2.00	3.00	2.00	39.3
257	295	11.1	5	234	326	2.5	0.33	2.00	3.00	2.00	38.9
257	295	11.1	5	234	326	2.5	0.33	2.00	3.00	2.00	39.1
257	295	11.1	5	234	326	2.5	0.33	2.00	3.00	2.00	38.5
257	295	11.1	5	234	326	2.5	0.33	2.00	3.00	2.00	39
265	310	16.7	7	238	352	3					54.8
265	310			238	352	3					53.2
265	310	16.7	7	238	352	3					54.3
265	310	16.7	7	238	352	3					52.4
268	320	16.7	7	238	352	3	0.30	2.30	3.40	2.20	54.7
268	320	16.7	7	238	352	3	0.30	2.30	3.40	2.20	54.6
268	320	16.7	7	238	352	3	0.30	2.30	3.40	2.20	53.1
268	320	16.7	7	238	352	3	0.30	2.30	3.40	2.20	52.7
262	308	11.1	6	238	352	3	0.40	1.70	2.50	1.60	66.4
275	344	16.7	8	238	382	3	0.27	2.50	3.70	2.50	63.5
275	344	16.7	8	238	382	3	0.27	2.50	3.70	2.50	63
275	344			238	382	3	0.27	2.50	3.70	2.50	63.2
272.5	334	16.7	8	238	382	3	0.36	1.89	2.81	1.85	77.3
293.5	384.5	22.3	12	246	422	4	0.32	2.09	3.11	2.04	119
293.5	384.5	22.3	12	246	422	4	0.32	2.09	3.11	2.04	119
266	295	9.5	4	252	308	2	0.15	4.50	6.70	4.50	15.1
266	295	9.5	4	252	308	2	0.15	4.50	6.70	4.50	14.9
266	295			252	308	2	0.15	4.50	6.70	4.50	15.8
278	317	13.9	6	254	346	2.5					23.3
278	317			254	346	2.5					34.9
278	317	13.9	6	254	346	2.5					34.8
278	317	13.9	6	254	346	2.5					33.9
278	317	13.9	6	254	346	2.5					34.5
278	317	13.9	6	254	346	2.5					33.5
278	322	13.9	6	254	346	2.5	0.24	2.80	4.20	2.80	34.2
278	322			254	346	2.5	0.24	2.80	4.20	2.80	34.2
278	322	13.9	6	254	346	2.5	0.24	2.80	4.20	2.80	32.2
278	322			254	346	2.5	0.24	2.80	4.20	2.80	34.2
278	318	11.1	5	254	346	2.5	0.30	2.30	3.40	2.20	44.1
278	318	11.1	5	254	346	2.5	0.30	2.30	3.40	2.20	43.7

Spherical Roller Bearing(CA)

d 240~260 mm

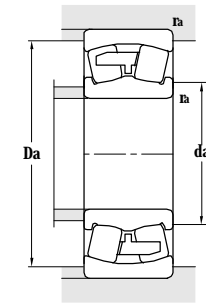
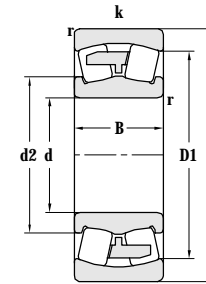
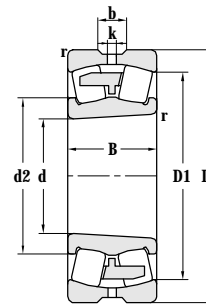
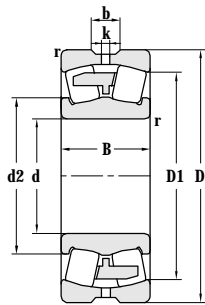

Principal dimensions				Basic load ratings		Limit speed ratings		Designations	
d	D	B	r _{min}	C _r	C _{0r}	Grease	Oil		
mm				kN		r/min			
240	360	118	3	1520	2800	800	1000	24048CAK30	24048CAK30/W33
	400	128	4	1550	2930	850	1100	23148	23148/W33
	400	128	4	1550	2930	850	1100	23148K	23148K/W33
	400	128	4	1550	2930	850	1100	23148F3	
	400	128	4	1980	3040	850	1100	23148CA	23148CA/W33
	400	128	4	1980	3040	850	1100	23148CAK/W33	
	400	160	4	2280	3750	480	600	24148/W33	
	400	160	4	2280	3750	480	600	24148F3/W33	
	400	160	4	2280	3705	480	600	24148CA	24148CA/W33
	400	160	4	2280	3705	480	600	24148CAK/W33	
	400	160	4	2280	3705	480	600	24148CAK30/C3W33	24148CAK30F3/W33
	440	120	4	2090	3250	900	1200	22248CA	22248CA/W33
	440	120	4	2090	3250	900	1200	22248CAK	22248CAK/W33
	440	120	4	2090	3250	900	1200	22248CAF3/C9W33	22248CAF3/W33
	440	120	4	2090	3250	900	1200	22248K/W33	
	440	160	4	2950	3950	670	850	23248CA/W33	
	440	160	4	2950	3950	670	850	23248CAK/W33	
	440	160	4	2950	3800	670	850	23248CAF3	
	500	155	5	2950	4100	650	800	22348CA	22348CA/W33
	500	155	5	2950	4100	650	800	22348CAK	22348CAK/W33
241	410	128	4	1860	3350	1000	1400	2650CA	
250	350	195	1.1					OH3156H	
	360	75	2.1	902	1750	1100	1500	23952CA	23952CA/W33
	410	128	4	1860	3350			2650CA	
260	360	75	2.1	835	1750	1100	1500	23952CA	23952CA/W33
	360	75	2.1	835	1750	1100	1500	23952CAK/W33	
	400	104	4	1520	2550	900	1200	23052CA	23052CA/W33
	400	104	4	1520	2550	900	1200	23052CAF3	
	400	104	4	1520	2550	900	1200	23052CAK	23052CAK/W33
	400	104	4	1520	2550	900	1200	23052CAKF3	
	400	140	4	1930	3500	700	900	24052CA/W33	
	400	140	4	1930	3800	700	900	24052CA/W33XYA	
	400	140	4	1930	3500	700	900	24052CAF3	24052CAF3/W33

Other dimensions				Contact surface and chamfer dimensions			Calculation coefficient				Weight
d2	D1	b	k	da	Da	ra	e	Y1	Y2	Y0	
mm				mm	mm	mm	mm				
278	318	11.1	5	254	346	2.5	0.30	2.30	3.40	2.20	44.1
290	347	16.7	8	258	382	3					47.5
290	347	16.7	8	258	382	3					65.6
290	347			258	382	3					66.7
289	345	16.7	8	258	382	3	0.31	2.21	3.29	2.16	68.2
289	345	16.7	8	258	382	3	0.31	2.21	3.29	2.16	66.5
285	336	11.1	6	258	382	3					81
285	336	11.1	6	258	382	3					80
285	336	11.1	6	258	382	3	0.40	1.70	2.50	1.60	79
285	336	11.1	6	258	382	3	0.40	1.70	2.50	1.60	75.6
285	336	11.1	6	258	382	3	0.40	1.70	2.50	1.60	77.8
290	383	18	7	258	422	3	0.27	2.50	3.70	2.50	85.3
290	383	18	7	258	422	3	0.27	2.50	3.70	2.50	82.4
303	379	18	7	258	422	3	0.27	2.50	3.70	2.50	85
305	379	18	7	258	422	3	0.27	2.50	3.70	2.50	84.1
292	369	22.3	8	258	422	3	0.35	1.90	2.90	1.80	102
292	369	22.3	8	258	422	3	0.35	1.90	2.90	1.80	102
292	369			258	422	3	0.35	1.90	2.90	1.80	102
330	390	22.3	12	297	439	4	0.32	2.09	3.11	2.04	146
330	390	22.3	12	297	439	4	0.32	2.09	3.11	2.04	145
299	356			272	382	3	0.29	2.30	3.50	2.40	59.4
294	328	12	6	272	348	2	0.18	3.80	5.60	3.60	25.9
298	356			271	390	3					59.4
287	331	12	6	271	348	2	0.18	3.80	5.60	3.60	24.4
287	331	12	6	271	348	2	0.18	3.80	5.60	3.60	24.2
306	357	16.7	7	278	382	3	0.23	2.90	4.40	2.80	49.8
306	357			278	382	3	0.23	2.90	4.40	2.80	49.5
306	357	16.7	7	278	382	3	0.23	2.90	4.40	2.80	46.9
306	357			278	382	3	0.23	2.90	4.40	2.80	46.6
300	347	11.1	6	278	382	3	0.33	2.00	3.00	2.00	66.7
300	347	11.1	6	278	382	3	0.33	2.00	3.00	2.00	67.2
300	347	11.1	6	278	382	3	0.33	2.00	3.00	2.00	64.9

Spherical Roller Bearing(CA)

d 260~280 mm

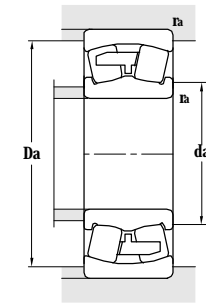
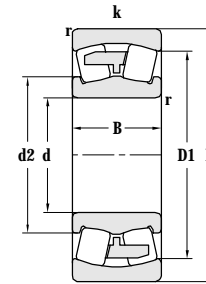
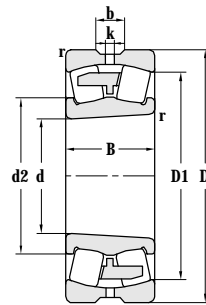
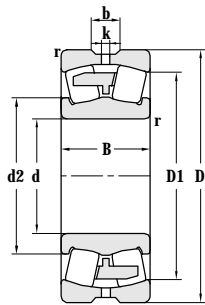

Principal dimensions				Basic load ratings		Limit speed ratings		Designations
d	D	B	r _{min}	C _r	C _{0r}	Grease	Oil	
mm				kN		r/min		
260	400	140	4	1930	3500	700	900	24052CAK30/W33
	440	144	4	2420	3700	800	1000	23152 23152/W33
	440	144	4	2420	3700	800	1000	23152K
	440	144	4	2420	3750	800	1000	23152K/HG2YA6
	440	144	4	2420	3750	800	1000	23152K/HG2YAB
	440	144	4	2420	3700	800	1000	23152F3
	440	144	4	2420	3750	800	1000	23152CA 23152CA/W33
	440	144	4	2420	3750	800	1000	23152CAK 23152CAK/W33
	440	144	4	2420	3750	800	1000	23152CAK/HG2C9YA6/W33
	440	144	4	2420	3750	800	1000	23152CAK30 23152CAK30/W33
	440	180	4	2850	4560	430	530	24152CA 24152CA/W33
	440	180	4	2850	4560	430	530	24152CA/HAW36 24152CAQ1/HAW36
	440	180	4	2850	4560	430	530	24152CAK30/W33
	440	180	4	2850	4560	430	530	24152CAF3/W33
	440	180	4	2420	4380	430	530	SX-24152
	480	130	5	2520	3600	850	1100	22252CA 22252CA/W33
	480	130	5	2520	3600	850	1100	22252CAK
	480	174	5	2800	4600	630	800	23252/HG2W33T
	480	174	5	3090	4750	630	800	23252CA/W33
	480	174	5	3090	4750	630	800	23252CA/W33X 23252CA/W33T
	480	174	5	3090	4750	630	800	23252CA/W33XB
	480	174	5	3090	4750	630	800	23252CAF3/W33
	480	174	5	3090	4750	630	800	23252CAK/W33
	480	174	5	3090	4750	630	800	23252CAKL/W33
	540	165	6	3370	4700	630	800	22352 22352/W33
	540	165	6	3370	4700	630	800	22352K 22352K/W33
	540	165	6	3370	4700	630	800	22352F3
	540	165	6	3370	4750	630	800	22352CA/W33
	540	165	6	3370	4750	630	800	22352CAK/W33
	540	165	6	3370	4750	630	800	22352CAF3 22352CAF3/W33
540	165	6	3370	4750	630	800	22352CAKF3/W33	
280	350	52	2	435	1230	1200	1500	23856CA 23856CA/W33
	380	75	2.1	805	1850	1000	1400	23956CA 23956CA/W33
	380	75	2.1	805	1850	1000	1400	23956CAQ1/W33
	420	106	4	1640	2810	850	1100	23056 23056/W33

Other dimensions				Contact surface and chamfer dimensions			Calculation coefficient				Weight
d2	D1	b	k	da	Da	ra	e	Y1	Y2	Y0	
mm				mm			mm				kg
300	347	11.1	6	278	382	3	0.33	2.00	3.00	2.00	65.2
318	372	16.7	12	278	422	3					92.1
318	372			278	422	3					90.2
310	380			278	422	3					94.4
310	380			278	422	3					94.4
318	372			278	422	3					91.6
310	379	16.7	9	278	422	3	0.31	2.20	3.30	2.20	88.9
310	379	16.7	9	278	422	3	0.31	2.20	3.30	2.20	88.7
310	379	16.7	9	278	422	3	0.31	2.20	3.30	2.20	88.7
310	379	16.7	9	278	422	3	0.31	2.20	3.30	2.20	86.7
312	366	13.9	8	278	422	3	0.39	1.73	2.58	1.69	115
312	366	13.9	8	278	422	3	0.39	1.73	2.58	1.69	114
312	366	13.9	8	278	422	3	0.39	1.73	2.58	1.69	112
312	366	13.9	8	278	422	3	0.39	1.73	2.58	1.69	113
312	366	13.9	8	278	422	3	0.39	1.73	2.58	1.69	114
330	414	22.3	12	282	458	4	0.27	2.51	3.74	2.45	106
330	414			282	458	4	0.27	2.51	3.74	2.45	105
320	404	27	16	282	458	4					138
320	404	22.3	8	282	458	4	0.35	1.90	2.90	1.80	141
320	404	22.3	12	282	458	4	0.35	1.90	2.90	1.80	141
320	404	25	15	282	458	4	0.35	1.90	2.90	1.80	141
320	404	22.3	8	282	458	4	0.35	1.90	2.90	1.80	138
320	404	22.3	8	282	458	4	0.35	1.90	2.90	1.80	139
320	404	22.3	8	282	458	4	0.35	1.90	2.90	1.80	137
349	446	24	10	288	512	5					191
349	446	24	10	288	512	5					190
349	446			288	512	5					190
349	455	22.3	8	288	512	5	0.31	2.20	3.30	2.20	186
349	455	22.3	8	288	512	5	0.31	2.20	3.30	2.20	185
349	455	22.3	8	288	512	5	0.31	2.20	3.30	2.20	184
349	455	22.3	8	288	512	5	0.31	2.20	3.30	2.20	183
305	328	8.3	4.5	278	348	2	0.13	5.36	7.98	5.24	11.4
316	346	12	6	292	368	2	0.18	3.80	5.66	3.72	25.3
316	346	12	6	292	368	2	0.18	3.80	5.66	3.72	25.7
326	371	16.7	7	296	400	3					54.9

Spherical Roller Bearing(CA)

d 280~300 mm

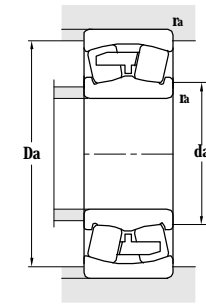
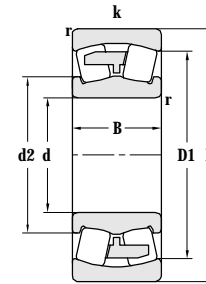
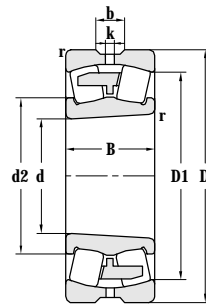
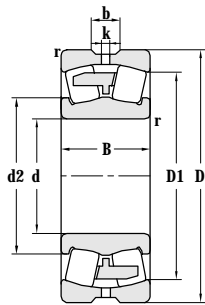

Principal dimensions				Basic load ratings		Limit speed ratings		Designations	
d	D	B	r _{min}	C _r	C _{0r}	Grease	Oil		
mm				kN		r/min			
280	420	106	4	1640	2810	850	1100	23056K 23056K/W33	
	420	106	4	1640	2810	850	1100	23056X1K	
	420	106	4	1640	2810	850	1100	23056F3 23056F3/W33	
	420	106	4	1640	2810	850	1100	23056KF3	
	420	106	4	1640	2850	850	1100	23056CA 23056CA/W33	
	420	106	4	1640	2850	850	1100	23056CAK 23056CAK/W33	
	420	140	4	2050	3700	670	850	24056CA/W33	
	420	140	4	2050	3700	670	850	24056CA/W33X 24056CA/W33YA2	
	420	140	4	2050	3700	670	850	24056CAF3 24056CAF3/W33	
	420	140	4	2050	3700	670	850	24056CAK30F3 24056CAK30F3/W33	
	460	146	5	2520	4200	800	1000	23156/W33	
	460	146	5	2520	4150	750	950	23156CA 23156CA/W33	
	460	146	5	2520	4150	750	950	23156CAF3	
	460	146	5	2520	4150	750	950	23156CAKF3	
	460	146	5	2520	4150	750	950	23156CAK 23156CAK/W33	
	460	130	5	2520	4150	750	950	23156X2CA	
	460	180	5	2900	4950	400	500	24156CA 24156CA/W33	
	460	180	5	2900	4950	400	500	24156CAK30/W33	
	460	180	5	2900	4950	400	500	24156CA/HCW33	
	500	130	5	2570	3600	800	1000	22256CA 22256CA/W33	
	500	130	5	2570	3600	800	1000	22256CAK 22256CAK/W33	
	500	130	5	2570	3600	800	1000	22256CAF3	
	500	130	5	2130	3300	850	1100	22256/W33	
	500	130	5	2130	3300	850	1100	22256K/W33	
	500	176	5	3080	5100	600	750	23256CA 23256CA/W33	
	500	176	5	3080	5100	600	750	23256CAF3 23256CAF3/W33	
	500	176	5	3080	5100	600	750	23256CAK/W33	
	500	176	5	3080	5100	600	750	23256CAKF3/W33	
	580	175	6	3200	5600	600	750	22356 22356/W33	
	580	175	6	3800	5700	600	750	22356CA 22356CA/W33	
	580	175	6	3800	5700	600	750	22356CAK/W33	
	580	175	6	3800	5700	600	750	22356CAF3/W33	
	300	380	60	3	640	1580	950	1400	23860CA/W33
		380	60	3	640	1580	950	1400	23860CAK/W33

Other dimensions				Contact surface and chamfer dimensions			Calculation coefficient				Weight kg
d2	D1	b	k	da	Da	ra	e	Y1	Y2	Y0	
mm				mm	mm	mm	mm				
326	371	16.7	7	296	400	3					53.4
326	371			296	400	3					57.6
326	371	16.7	7	296	400	3					54.6
326	371			296	400	3					53.1
323	377	16.7	7	298	402	3	0.23	2.91	4.40	2.84	56.8
323	377	16.7	7	298	402	3	0.23	2.91	4.40	2.84	56.6
317	366	11.1	6	298	402	3	0.31	2.20	3.30	2.20	66.8
317	366	11.1	6	298	402	3	0.31	2.20	3.30	2.20	68.6
317	366	11.1	6	298	402	3	0.31	2.20	3.30	2.20	66.8
317	366	11.1	6	298	402	3	0.31	2.20	3.30	2.20	67.2
337	400	16.7	8	302	438	4	0.32	2.09	3.11	2.04	99.1
333	400	16.7	8	302	438	4	0.30	2.30	3.40	2.20	104
333	400			302	438	4	0.30	2.30	3.40	2.20	103
333	400			302	438	4	0.30	2.30	3.40	2.20	100
333	400	16.7	8	302	438	4	0.30	2.30	3.40	2.20	96.9
332	404			302	438	4	0.27	2.50	3.72	2.45	87
327	393	13.9	8	302	438	4	0.40	1.70	2.50	1.60	118
327	393	13.9	8	302	438	4	0.40	1.70	2.50	1.60	115
327	388	13.9	8	302	438	4	0.40	1.70	2.50	1.60	118
347	435	22.3	8	302	478	4	0.26	2.60	3.90	2.50	118
347	435	22.3	8	302	478	4	0.26	2.60	3.90	2.50	117
347	435			302	478	4	0.26	2.60	3.90	2.50	117
348	435	22.3	8	302	478	4	0.27	2.50	3.70	2.50	113
348	435	22.3	8	302	478	4	0.27	2.50	3.70	2.50	109
340	424	22.3	8	302	478	4	0.35	1.90	2.90	1.80	147
340	424	22.3	8	302	478	4	0.35	1.90	2.90	1.80	146
340	424	22.3	8	302	478	4	0.35	1.90	2.90	1.80	153
340	424	22.3	8	302	478	4	0.35	1.90	2.90	1.80	142
372	485	22.3	8	314	552	5	0.32	2.09	3.11	2.04	230
364	485	22.3	8	308	552	5	0.30	2.30	3.40	2.20	221
364	485	22.3	8	308	552	5	0.30	2.30	3.40	2.20	217
364	485	22.3	8	308	552	5	0.30	2.30	3.40	2.20	221
328	357	12	6	310	368	2	0.13	5.20	7.70	5.00	16.8
	328	357	12	310	368	2	0.13	5.20	7.70	5.00	17.6

Spherical Roller Bearing(CA)

d 300 mm

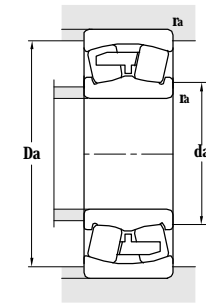
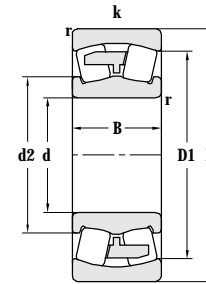
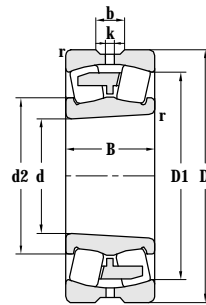
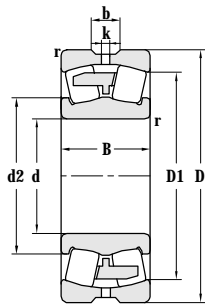

Principal dimensions				Basic load ratings		Limit speed ratings		Designations
d	D	B	r _{min}	C _r	C _{OR}	Grease	Oil	
mm				kN		r/min		
300	420	90	3	1140	2500	950	1300	23960CA/W33
	420	90	3	1140	2500	950	1300	23960CAK
	420	118	3	1580	3600	950	1300	24960CA/W33
	440	105	4	2010	3450	870	1100	23060X3CA/W33
	460	118	4	1400	3200	800	1000	23060/W33
	460	118	4	1400	3200	800	1000	23060F3
	460	118	4	1400	3200	800	1000	23060KF3
	460	118	4	1400	3200	800	1000	23060KQ1/W33
	460	118	4	2010	3450	800	1000	23060CA
	460	118	4	2010	3450	800	1000	23060CAK
	460	118	4	2010	3450	800	1000	23060CAK/C9W33
	460	118	4	2010	3450	800	1000	23060CAF3/W33
	460	160	4	2570	4750	600	750	24060CA
	500	160	5	3040	4850	670	850	23160CA
	500	160	5	3040	4850	670	850	23160CAF1
	500	160	5	3040	4850	670	850	23160CA/HCEC9W33
	500	160	5	3040	4850	670	850	23160CAF3
	500	160	5	3040	4850	670	850	23160CAF3
	500	160	5	3040	4850	670	850	23160CAF3
	500	160	5	3040	4850	670	850	23160CAF3
	500	160	5	3040	4850	670	850	23160CAF3
	500	200	5	3560	5990	600	750	24160CA
	500	200	5	3560	5990	600	750	24160CAK30/W33
	540	140	5	2990	4300	750	950	22260CA
	540	140	5	2990	4300	750	950	22260CAF3
	540	140	5	2990	4300	750	950	22260CAF3
	540	140	5	2990	4040	800	1000	22260/W33
	540	140	5	2990	4040	800	1000	22260K/W33
	540	192	5	3700	5560	530	670	23260CAF1
	540	192	5	3700	5560	530	670	23260CAF1/W33
	540	192	5	3150	5300	530	670	23260/YA3
	540	192	5	3700	5950	530	670	23260CA
	540	192	5	3700	5950	530	670	23260CAK/W33
	540	192	5	3700	5950	530	670	23260CA/W33T
	540	192	5	3700	5950	530	670	23260CAF1
	540	192	5	3700	5950	530	670	23260CAF3/W33
	540	192	5	3700	5950	530	670	23260CAK/W33
	620	185	7.5	3950	6000			22360CA

Other dimensions				Contact surface and chamfer dimensions			Calculation coefficient				Weight
d2	D1	b	k	da	Da	ra	e	Y1	Y2	Y0	
mm				mm			mm				kg
339	382	15	6	314	406	2.5	0.19	3.60	5.30	3.60	40.1
339	382			314	406	2.5	0.19	3.60	5.30	3.60	39
339	376	18	7								52.8
343	396	16.7	9	302	438	3	0.21	3.16	4.71	3.09	54.7
351	406	16.7	7	322	438	3					70.4
351	406	16.7	7	322	438	3					69.8
351	406	16.7	7	322	438	3					69.5
351	409	16.7	7	318	442	3					70.3
351	409	16.7	7	318	442	3	0.23	2.90	4.40	2.80	75.8
351	409	16.7	7	318	442	3	0.23	2.90	4.40	2.80	73.6
351	409	16.7	7	318	442	3	0.23	2.90	4.40	2.80	73.4
351	409	16.7	7	318	442	3	0.23	2.90	4.40	2.80	74.9
342	399	13.9	7	318	442	3	0.32	2.09	3.11	2.04	99
356	433	16.7	8	322	478	4	0.30	2.30	3.40	2.20	127
356	433	16.7	9	322	478	4	0.30	2.30	3.40	2.20	143
356	433	16.7	9	322	478	4	0.30	2.30	3.40	2.20	126
356	433	16.7	8	322	478	4	0.30	2.30	3.40	2.20	127
356	433	16.7	8	322	478	4	0.30	2.30	3.40	2.20	123
356	433	16.7	9	322	478	4	0.30	2.30	3.40	2.20	123
356	420	13.9	6	322	478	4	0.39	1.75	2.61	1.71	160
356	420	13.9	6	322	478	4	0.39	1.75	2.61	1.71	157
374	467			322	518	4	0.26	2.60	3.90	2.50	138
374	467	22.3	8	322	518	4	0.26	2.60	3.90	2.50	136
374	467			322	518	4	0.26	2.60	3.90	2.50	136
374	467	22.3	8	322	518	4	0.27	2.50	3.70	2.50	140
374	467	22.3	8	322	518	4	0.27	2.50	3.70	2.50	137
373	455	22	10	322	518	4	0.35	1.90	2.90	1.80	192
373	455	22	10	322	518	4	0.35	1.90	2.90	1.80	190
373	455	22	10	322	518	4	0.35	1.90	2.90	1.80	194
373	455	22	10	322	518	4	0.35	1.90	2.90	1.80	190
373	455	22	10	322	518	4					187
373	455	22	10	322	518	4					193
373	455	22	10	322	518	4					194
373	455	22	10	322	518	4					192
373	455	22	10	322	518	4	0.35	1.90	2.90	1.80	189
396	523			335	586	6					271

Spherical Roller Bearing(CA)

d 318~340 mm

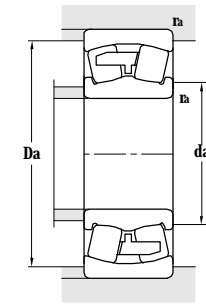
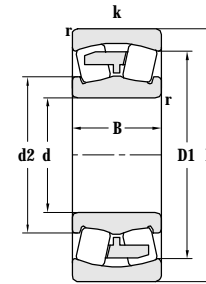
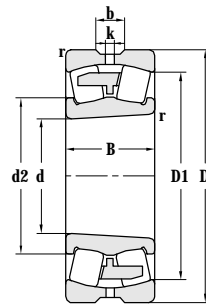
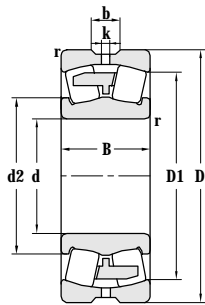

Principal dimensions				Basic load ratings		Limit speed ratings		Designations
d	D	B	r _{min}	C _r	C _{0r}	Grease	Oil	
mm				kN		r/min		
318	620	224	6	4350	7600			206/318/C9
320	400	60	2.1	670	1620	920	1280	23864CA/W33
	400	60	2.1	670	1620	920	1280	23864CAK/W33
	440	90	3	1360	2650	900	1200	23964CA 23964CA/W33
	440	90	3	1360	2650	900	1200	23964CAK/W33
	480	121	4	2130	3610	800	1000	23064 23064/W33
	480	121	4	2130	3610	800	1000	23064K
	480	121	4	2130	3610	800	1000	23064F3
	480	121	4	2130	3610	800	1000	23064/YA2
	480	121	4	2130	3900	800	1000	23064CA 23064CA/W33
	480	121	4	2130	3900	800	1000	23064CAK 23064CAK/W33
	480	121	4	2130	3900	800	1000	23064CAF3/W33
	480	160	4	2700	5100	560	700	24064CA 24064CA/W33
	480	160	4	2700	5100	560	700	24064CAF3 24064CAF3/W33
	480	160	4	2700	5100	560	700	24064CAK30/W33
	540	176	5	2990	5350	630	800	23164K/W33
	540	176	5	3560	5700	630	800	23164CA 23164CA/W33
	540	176	5	3560	5700	630	800	23164CAK 23164CAK/W33
	540	210	5	4040	6750	340	430	24164CA/W33 24164CA/W33T
	540	210	5	4040	6750	340	430	24164CAK30/W33
	580	150	5	3420	4660	670	850	22264CA 22264CA/W33
	580	150	5	3420	4660	670	850	22264CAK
	580	150	5	3420	4660	700	900	22264/W33
	580	150	5	3420	4660	700	900	22264K/W33
	580	208	5	4180	6370	500	630	23264 23264/W33
	580	208	5	4180	6820	500	630	23264CA 23264CA/W33
	580	208	5	4180	6820	500	630	23264CA/YA1/W33
	580	208	5	4180	6820	500	630	23264CAF3 23264CAF3/W33
	580	208	5	4180	6820	500	630	23264CAK/W33
	580	208	5	4180	6820	500	630	23264CAK/W33
	670	200	7.5	4530	6820	450	600	22364CAK/W33
340	460	90	3	1390	2660	900	1200	23968CA/W33
	460	90	3	1390	2700	900	1200	23968CAK/W33
	460	90	3	1390	2660	900	1200	23968CAF3/W33

Other dimensions				Contact surface and chamfer dimensions			Calculation coefficient				Weight
d2	D1	b	k	da	Da	ra	e	Y1	Y2	Y0	
mm				mm	mm	mm	mm				
424	524			348	578	5					320
346	376	13.9	6	332	388	2	0.12	5.60	8.40	5.60	20.5
346	376	13.9	6	332	388	2	0.12	5.60	8.40	5.60	20.3
360	402	15	6	338	426	2.5	0.18	3.80	5.60	3.60	41.8
360	405	15	6	360	427	2.5	0.18	3.80	5.60	3.60	40.4
368	431	22	8	338	462	3					78.5
368	431										76.1
368	431			338	462	3					77.5
368	431			338	462	3					78.9
368	431	16.7	8	338	462	3	0.23	2.90	4.40	2.80	84.8
368	431	16.7	8	338	462	3	0.23	2.90	4.40	2.80	84.3
368	431	16.7	8	338	462	3	0.23	2.90	4.40	2.80	84.7
368	421	22	8	338	462	3	0.32	2.09	3.11	2.04	106
368	421	22	8	338	462	3	0.32	2.09	3.11	2.04	106
368	421	22	8	338	462	3	0.32	2.09	3.11	2.04	103
387	465	22.3	12	342	518	4					165
389	465	22.3	8	342	518	4	0.31	2.20	3.30	2.20	200
389	465	22.3	8	342	518	4	0.31	2.20	3.30	2.20	195
364	455	17.7	9.5	342	518	4	0.40	1.70	2.50	1.60	206
364	455	17.7	9.5	342	518	4	0.40	1.70	2.50	1.60	203
400	502	22.3	8	342	558	4	0.26	2.60	3.90	2.50	175
400	502			342	558	4	0.26	2.60	3.90	2.50	172
400	502	22.3	8	342	558	4	0.27	2.50	3.70	2.50	177
400	502	22.3	8	342	558	4	0.27	2.50	3.70	2.50	173
400	490			342	558	4	0.35	1.90	2.90	1.80	247
400	490	22.3	10	342	558	4	0.35	1.90	2.90	1.80	250
400	490	22.3	10	342	558	4	0.35	1.90	2.90	1.80	248
400	490	22.3	10	342	558	4	0.35	1.90	2.90	1.80	252
400	490	22.3	10	342	558	4	0.35	1.90	2.90	1.80	240
400	490	22.3	10	342	558	4	0.35	1.9	2.9	1.8	241
430	566	22.3	12	355	635	6					344
378	423	15	6	354	446	2.5	0.17	4.00	5.90	4.00	46
378	423	15	6	354	446	2.5	0.17	4.00	5.90	4.00	45.9
378	423	15	6	354	446	2.5	0.17	4.00	5.90	4.00	57.3

Spherical Roller Bearing(CA)

d 340~360 mm

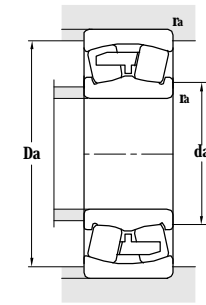
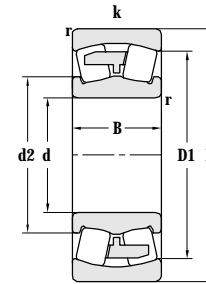
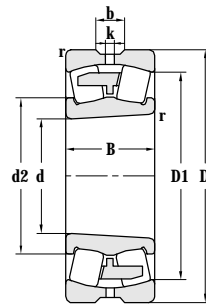
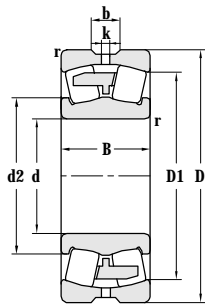

Principal dimensions				Basic load ratings		Limit speed ratings		Designations
d	D	B	r _{min}	C _r	C _{0r}	Grease	Oil	
mm				kN		r/min		
340	520	133	5	2570	4400	700	900	23068CA 23068CA/W33
	520	133	5	2570	4400	700	900	23068CA/W33YA1
	520	133	5	2570	4400	700	900	23068CAK
	520	133	5	2570	4400	700	900	23068CAF3 23068CAF3/W33
	520	133	5	2570	4400	700	900	23068CAKF3 23068CAKF3/W33
	520	133	5	2570	4400	700	900	23068CAK/W33
	520	180	5	3280	5890	530	670	24068CA/W33 24068CA/C9W33
	520	180	5	3280	5890	530	670	24068CAK/W33
	520	180	5	3280	5890	530	670	24068CAF1/HA 24068CAF1/W33
	520	180	5	3280	5890	530	670	24068CK30/W33
	520	180	5	3280	5890	530	670	24068CAF3 24068CAF3/W33
	520	180	5	3280	5890	530	670	24068CAK30F1 24068CAK30F1/W33
	520	180	5	3280	5890	530	670	24068CAK30F3 24068CAK30F3/W33
	580	190	5	4040	6460	600	750	23168CA 23168CA/W33
	580	190	5	4040	6460	600	750	23168CAK/W33
	580	190	5	4040	6460	600	750	23168CAF3/W33
	580	190	5	4040	6460	600	750	23168CAKF3/W33
	580	243	5	5040	8220	320	400	24168CA/W33
	580	243	5	5040	8220	320	400	24168CAK30/W33
	580	243	5	5040	8220	320	400	24168CAK30F3/W33
	620	224	6	4350	7600	430	530	23268
	620	224	6	5000	8150	500	700	23268CA 23268CA/W33
620	224	6	5000	8150	500	700	23268CAK 23268CAK/W33	
360	480	90	3	1390	3000	850	1100	23972CA 23972CA/W33
	480	90	3	1330	2610	850	1100	23972CAK/W33
	540	134	5	2610	4800	670	850	23072CA 23072CA/W33
	540	134	5	2610	4800	670	850	23072CAK
	540	134	5	2610	4800	670	850	23072CAF3 23072CAF1
	540	134	5	2610	4800	670	850	23072CAKF3/W33
	540	134	5	2610	4800	670	850	23072CAF3/HAW33 23072CAF3/W33
	540	180	5	3370	6220	600	750	24072CA 24072CA/W33
	540	180	5	3370	6220	600	750	24072CAK/W33
	540	180	5	3370	6220	600	750	24072CAK30
	600	192	5	3400	6200	560	700	23172K/W33
	600	192	5	4080	6850	560	700	23172CA 23172CA/W33

Other dimensions				Contact surface and chamfer dimensions			Calculation coefficient				Weight kg
d2	D1	b	k	da	Da	ra	e	Y1	Y2	Y0	
mm				mm	mm	mm	mm				
400	464	22.3	8	362	498	4	0.24	2.80	4.20	2.80	115
400	464	22.3	8	362	498	4	0.24	2.80	4.20	2.80	114
400	464	22.3	8	362	498	4	0.24	2.80	4.20	2.80	112
400	464	22.3	8	362	498	4	0.24	2.80	4.20	2.80	114
400	464	22.3	8	362	498	4	0.24	2.80	4.20	2.80	111
400	464	22.3	8	362	498	4	0.24	2.80	4.20	2.80	111
400	464	22.3	8	362	498	4	0.24	2.80	4.20	2.80	111
394	451	16.7	8	362	498	4	0.33	2.00	3.00	2.00	137
394	451	16.7	8	362	498	4	0.33	2.00	3.00	2.00	132
394	451	16.7	8	362	498	4	0.33	2.00	3.00	2.00	136
377	453	16.7	9	358	502	4	0.33	2.00	3.00	2.00	137
394	451	16.7	8	362	498	4	0.33	2.00	3.00	2.00	136
394	451	16.7	8	362	498	4	0.33	2.00	3.00	2.00	134
394	451	16.7	8	362	498	4	0.33	2.00	3.00	2.00	134
412	497	22.3	8	362	558	4	0.31	2.20	3.30	2.20	211
412	497	22.3	8	362	558	4	0.31	2.20	3.30	2.20	208
412	497	22.3	8	362	558	4	0.31	2.20	3.30	2.20	210
412	497	22.3	8	362	558	4	0.31	2.20	3.30	2.20	206
408	486	22.3	10	362	558	4	0.4	1.7	2.5	1.6	261
408	486	22.3	10	362	558	4	0.40	1.70	2.50	1.60	256
408	486	22.3	10	362	558	4	0.40	1.70	2.50	1.60	258
424	524			368	592	5	0.35	1.9	2.9	1.8	300
426	528			368	592	5	0.35	1.90	2.90	1.80	299
426	528	22.3	12	368	592	5	0.35	1.90	2.90	1.80	290
403	441	11.1	6	374	466	2.5	0.16	4.20	6.30	4.00	45.9
403	441	11.1	6	374	466	2.5	0.16	4.20	6.30	4.00	46.4
419	486	22.3	8	382	518	4	0.23	2.90	4.40	2.80	126
419	486			382	518	4	0.23	2.90	4.40	2.80	125
419	486			382	518	4	0.23	2.90	4.40	2.80	125
419	486			382	518	4	0.23	2.90	4.40	2.80	124
419	486	22.3	8	382	518	4	0.23	2.90	4.40	2.80	125
419	486	22.3	8	382	518	4	0.23	2.90	4.40	2.80	125
398	474	16.7	8	382	518	4	0.31	2.2	3.3	2.2	147
398	474	16.7	8	382	518	4	0.31	2.20	3.30	2.20	143
398	474			382	518	4	0.31	2.2	3.3	2.2	148
434	518	22.3	12	382	578	4	0.30	2.30	3.40	2.20	218
434	518	22.3	12	382	578	4	0.30	2.30	3.40	2.20	224

Spherical Roller Bearing(CA)

d 360~380 mm

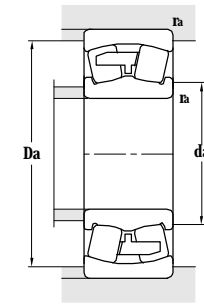
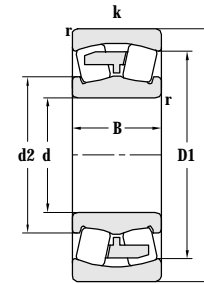
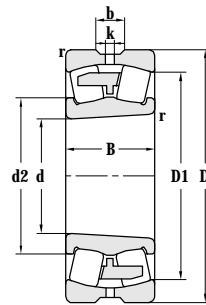
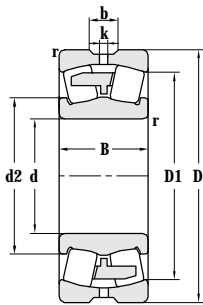

Principal dimensions				Basic load ratings		Limit speed ratings		Designations	
d	D	B	r _{min}	C _r	C _{0r}	Grease	Oil		
mm				kN		r/min			
360	600	192	5	4080	6850	560	700	23172CAK/W33	
	600	192	5	4080	6850	560	700	23172CAKF1/W33	
	600	243	5	5320	8840	300	380	24172CA 24172CA/W33	
	600	243	5	5320	8840	300	380	24172CA/W36	
	600	243	5	5320	8840	300	380	24172CAF1 24172CAF1/W33	
	600	243	5	5320	8840	300	380	24172CAK30/W33	
	600	243	5	5320	8840	300	380	24172CAK30F1/W33 24172CAK30F3/W33	
	600	243	5	5320	8840	300	380	24172CAQ1/W36	
	600	243	5	5600	8400	300	380	SX-24172	
	650	170	6	4200	6200	600	800	22272CA/W33	
	650	232	6	5130	7880	400	500	23272 23272/W33	
	650	232	6	5300	9050	500	700	23272CA 23272CA/W33	
	650	232	6	5300	9050	500	700	23272CAK 23272CAK/W33	
	650	232	6	5300	9050	500	700	23272CAKF3/W33	
	750	224	7.5	5650	8600	400	500	22372CA 22372CA/W33	
	750	224	7.5	5650	8600	400	500	22372CAK 22372CAK/W33	
	750	224	7.5	5650	8600	400	500	22372CAF3	
	750	224	7.5	5650	8600	400	500	22372CAKF3	
	380	520	106	4	1860	3900	800	1000	23976CA/W33
		520	106	4	1860	3900	800	1000	23976CAF1/W33 23976CAF3/W33
560		135	5	2750	5000	630	800	23076CA 23076CA/W33	
560		135	5	2750	5000	630	800	23076CAK/W33	
560		135	5	2750	5000	630	800	23076CAF1/W33 23076CAF3/W33	
560		135	5	2750	5000	630	800	23076CAKF3 23076CAKF3/W33	
560		180	5	3420	6550	480	600	24076CA/W33	
560		180	5	3420	6550	480	600	24076CAF3 24076CAF3/W33	
560		180	5	3420	6550	480	600	24076CAK30F3/W33	
620		194	5	4180	7300	400	500	23176/W33	
620		194	5	4300	7750	500	900	23176CA 23176CA/W33	
620		194	5	4300	7750	500	900	23176CA/W33T	
620		194	5	4300	7750	500	900	23176CAK 23176CAK/W33	
620		194	5	4300	7750	500	900	23176CAK30/W33	
620		194	5	4300	7750	500	900	23176CAF3/HAW33 23176CAF3/W33	
620		194	5	4300	7750	500	900	23176CAKF3 23176CAKF3/W33	
620		194	5	4300	7750	500	900	23176CAK/W33	

Other dimensions				Contact surface and chamfer dimensions			Calculation coefficient				Weight
d2	D1	b	k	da	Da	ra	e	Y1	Y2	Y0	
mm				mm	mm	mm	mm				kg
434	518	22.3	12	382	578	4	0.30	2.30	3.40	2.20	223
434	518	22.3	12	382	578	4	0.30	2.30	3.40	2.20	222
430	511	20	12	382	578	4	0.37	1.80	2.70	1.80	270
430	511	20	8	382	578	4	0.37	1.80	2.70	1.80	270
430	511	20	12	382	578	4	0.37	1.80	2.70	1.80	269
430	511	20	12	382	578	4	0.37	1.80	2.70	1.80	267
430	511	20	12	382	578	4	0.37	1.80	2.70	1.80	268
430	511	20	12	382	578	4	0.37	1.80	2.70	1.80	270
430	511	20	8	382	578	4	0.37	1.80	2.70	1.80	271
449	563	22.3	8	388	622	5	0.26	2.60	3.87	2.54	248
443	547			388	622	5	0.35	1.90	2.90	1.80	341
443	547	22.3	10	388	622	5	0.35	1.90	2.90	1.80	332
443	547			388	622	5	0.35	1.90	2.90	1.80	329
443	547	22.3	10	388	622	5	0.35	1.90	2.90	1.80	327
471	631	22.3	12	392	720	6	0.31	2.21	3.29	2.16	469
471	631	22.3	12	392	720	6	0.31	2.21	3.29	2.16	443
471	631			392	720	6	0.31	2.21	3.29	2.16	466
471	631			392	720	6	0.31	2.21	3.29	2.16	441
426	476	15	10	398	502	3	0.17	4.00	5.90	4.00	69.9
426	476	15	10	398	502	3	0.17	4.00	5.90	4.00	69.5
441	505	22.3	8	402	538	4	0.22	3.00	4.60	2.80	125
441	505	22.3	8	402	538	4	0.22	3.00	4.60	2.80	122
441	505	22.3	8	402	538	4	0.22	3.00	4.60	2.80	129
441	505	22.3	8	402	538	4	0.22	3.00	4.60	2.80	125
441	505	22.3	8	402	538	4	0.3	2.3	3.4	2.2	151
435	494	22	10	402	538	4	0.30	2.30	3.40	2.20	150
435	494	22.3	8	402	538	4	0.30	2.30	3.40	2.20	153
435	494	22	10	402	538	4	0.30	2.30	3.40	2.20	153
457	540	22	8	402	598	4	0.30	2.30	3.40	2.20	237
457	540	22	8	402	598	4	0.3	2.3	3.4	2.2	249
457	540	27	16	402	598	4	0.30	2.30	3.40	2.20	248
457	540	22	8	402	598	4	0.30	2.30	3.40	2.20	242
457	540	22	8	402	598	4	0.30	2.30	3.40	2.20	241
457	540	22	8	402	598	4	0.30	2.30	3.40	2.20	248
457	540	22	8	402	598	4	0.30	2.30	3.40	2.20	241
457	540	22	8	402	598	4	0.30	2.30	3.40	2.20	243

Spherical Roller Bearing (CA)

d 380~420 mm

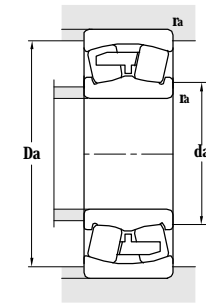
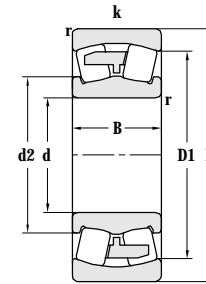
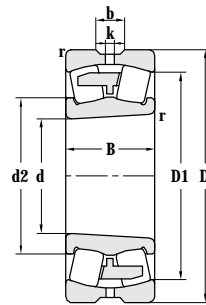
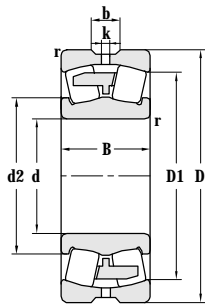

Principal dimensions				Basic load ratings		Limit speed ratings		Designations
d	D	B	r _{min}	C _r	C _{0r}	Grease	Oil	
mm				kN		r/min		
380	620	243	5	5420	9310	300	380	24176CA/C9 24176CA/W33
	620	243	5	5420	9310	300	380	24176CAK30/W33
	680	240	6	5750	9300	400	650	23276CA/W33
	680	240	6	5750	9300	400	650	23276CAKF3/W33 23176CAK30/W33
	780	230	7.5	6000	9300	350	500	22376CAF3 22376CAF3/W33
400	540	106	4	1900	4000	750	950	23980CA/W33
	540	106	4	1900	4000	750	950	23980CAK/W33
	540	106	4	1900	4000	750	950	23980CAF1/W33 23980CAF3/W33
	540	100	4	1900	4000	750	950	23980X2CAF3/W33 23980X2CAF3/W33YA1
	590	142	5	3090	5500	630	800	23080X3CA 23080X3CA/W33
	600	148	5	3090	5500	600	750	23080CA 23080CA/P5W33
	600	148	5	3090	5500	600	750	23080CAK/W33
	600	148	5	3090	5500	600	750	23080CAF3 23080CAF3/W33
	600	148	5	3090	5500	600	750	23080CAKF3 23080CAKF3/W33
	600	200	5	4090	7800	450	560	24080CA/W33
	600	200	5	4090	7800	450	560	24080CAF3 24080CAF3/W33
	600	200	5	4090	7800	450	560	24080CAK30/W33
	650	200	6	4160	7860	380	480	23180/W33
	650	200	6	4550	8200	500	900	23180CA 23180CA/W33
	650	200	6	4550	8200	500	900	23180CAF3 23180CAF3/W33
	650	200	6	4550	8200	500	900	23180CAKF3/W33 23180CAK/W33
	650	200	6	4550	8200	500	900	23180CA/HCRW33
	670	216	6	4200	8540	380	480	23180X3CA/W33
	650	250	6	5890	10070	320	400	24180CA 24180CA/W33
	650	250	6	5890	10070	320	400	24180CAF3 24180CAF3/W33
	650	250	6	5890	10070	320	400	24180CAK30/W33
	650	250	6	5890	10070	320	400	24180CA/HG2W33
	720	256	6	6450	11000	400	600	23280CA 23280CA/W33
	720	256	6	6450	11000	400	600	23280CAF3/W33 23280CAF3
	720	256	6	6450	11000	400	600	23280CAKF3/W33
	820	243	7.5	7400	10300	400	700	22380CA 22380CA/W33
	820	243	7.5	7400	10300	400	700	22380CA/HCW33 22380CA/W33
	420	520	75	2.1	950	2630	750	950
560		106	4	1950	4050	700	900	23984ACA/W33

Other dimensions				Contact surface and chamfer dimensions			Calculation coefficient				Weight
d2	D1	b	k	da	Da	ra	e	Y1	Y2	Y0	
mm				mm			mm				kg
457	540	16.7	9	402	598	4	0.30	2.30	3.40	2.20	296
457	540	16.7	9	402	598	4	0.30	2.30	3.40	2.20	290
471	581	22.3	12	406	654	5	0.35	1.90	2.90	1.80	389
468	574	22.3	10	408	652	5	0.35	1.90	2.90	1.80	386
504	660			415	740	6					518
445	497	15	10	418	522	3	0.17	4.00	5.90	4.00	72.9
445	497	15	10	418	522	3	0.17	4.00	5.90	4.00	71.3
445	497	15	10	418	522	3	0.17	4.00	5.90	4.00	72.4
445	498	13.9	7.5	418	522	3	0.16	4.20	6.30	4.00	67.8
461	532	22.3	12	422	578	4	0.21	3.14	4.68	3.07	133
460	538			422	578	4	0.23	2.90	4.40	2.80	147
460	538	22	12	422	578	4	0.23	2.90	4.40	2.80	141
460	538	22	12	422	578	4	0.23	2.90	4.40	2.80	146
460	538	22	12	422	578	4	0.23	2.90	4.40	2.80	142
458	524	22	12	422	578	4	0.30	2.30	3.40	2.20	203
458	524	22	12	422	578	4	0.30	2.30	3.40	2.20	202
458	524	22	12	422	578	4	0.3	2.3	3.4	2.2	202
475	568	22.3	8	428	622	5					210
480	568	22.3	8	428	622	5	0.28	2.40	3.60	2.50	273
480	568	22.3	8	428	622	5	0.28	2.40	3.60	2.50	271
480	568	22.3	8	428	622	5	0.28	2.40	3.60	2.50	264
480	568	22.3	8	428	622	5	0.28	2.40	3.60	2.50	272
480	579	22.3	8	428	622	5	0.28	2.40	3.60	2.50	293
476	563	22.3	8	428	622	5	0.36	1.87	2.79	1.83	326
476	563	22.3	8	428	622	5	0.36	1.87	2.79	1.83	323
476	563	22.3	8	428	622	5	0.36	1.87	2.79	1.83	320
476	563	22.3	8	428	622	5	0.36	1.87	2.79	1.83	325
499	606	22	10	428	692	5	0.35	1.90	2.90	1.80	468
499	606	22	10	428	692	5	0.35	1.90	2.90	1.80	465
499	606	22	10	428	692	5	0.35	1.90	2.90	1.80	452
520	694	22.3	12	442	790	6	0.31	2.21	3.29	2.16	623
520	694	22.3	12	442	790	6	0.31	2.21	3.29	2.16	623
454	490	13.9	5	430	504	2	0.12	5.60	8.40	5.60	34.6
464	517	16.7	9	435	545	3	0.16	4.20	6.30	4.00	72.4

Spherical Roller Bearing(CA)

d 420~460 mm

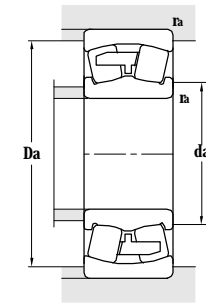
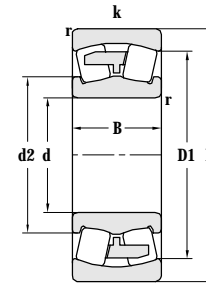
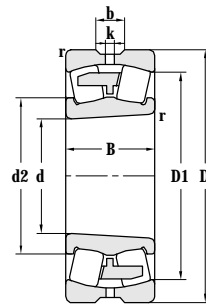
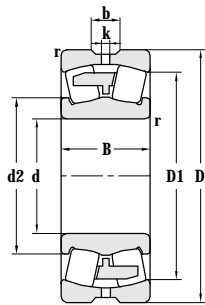

Principal dimensions				Basic load ratings		Limit speed ratings		Designations	
d	D	B	r _{min}	C _r	C _{0r}	Grease	Oil		
mm				kN		r/min			
420	560	106	4	1950	3950	700	900	23984CA/W33	
	620	150	5	3300	6400	500	1000	23084CA	
	620	150	5	3300	6400	500	1000	23084CAK/W33	
	620	150	5	3300	6400	500	1000	23084CAF3	
	620	150	5	3300	6400	500	1000	23084CAKF3	
	620	200	5	4180	8450	380	480	24084CA/W33	
	620	200	5	4180	8450	380	480	24084CAF3/W33	
	620	200	5	4180	8450	380	480	24084CAK30F3/W33X	
	700	224	6	5320	9200	360	450	23184CA/W33	
	700	224	6	5320	9200	360	450	23184CAK	
	700	224	6	5320	9200	360	450	23184CAF3	
	700	280	6	7000	11950	300	380	24184CA/W33	
	700	280	6	7000	11950	300	380	24184CAK30/W33	
	700	280	6	7000	11950	300	380	24184CA/HCRW33	
	760	272	7.5	7250	11900	400	550	23284CA/W33	
	760	272	7.5	7250	11900	400	550	23284CAK	
	760	272	7.5	7250	11900	400	550	23284CAF3/C9W33	
	440	600	118	4	2413	4850	450	560	23988CA/W33
600		118	4	2413	4850	450	560	23988CAF3/W33	
650		157	6	3550	6500	500	900	23088CA	
650		157	6	3550	6500	500	900	23088CAK/W33	
650		157	6	3550	6500	500	900	23088CAF3	
650		157	6	3550	6500	500	900	23088CAKF3	
650		212	6	4550	9100	360	450	24088CA/W33	
650		212	6	4550	9100	360	450	24088CA/HCW33	
650		212	6	4550	9100	360	450	24088CAK30F3/W33	
720		226	6	5900	10000	400	750	23188CA	
720		226	6	5900	10000	400	750	23188CAK/W33	
720		280	6	7120	12500	300	380	24188CA/W33	
720		280	6	7120	12500	300	380	24188CAK30/W33	
790		280	7.5	7700	12800	350	500	23288CA/W33	
790		280	7.5	7700	12800	350	500	23288CAK/W33	
460		580	118	3	1700	4655	450	560	24892CA
		580	118	3	1700	4655	450	560	24892CAK30/W33

Other dimensions				Contact surface and chamfer dimensions			Calculation coefficient				Weight
d2	D1	b	k	da	Da	ra	e	Y1	Y2	Y0	
mm				mm			mm				kg
464	517	16.7	9	435	545	3	0.16	4.20	6.30	4.00	73.6
484	558			442	598	4	0.22	3.00	4.60	2.80	149
484	558			442	598	4	0.22	3.00	4.60	2.80	143
484	558	22	8	442	598	4	0.22	3.00	4.60	2.80	148
484	558	22	8	442	598	4	0.22	3.00	4.60	2.80	143
479	548	22.3	12	442	598	4	0.30	2.30	3.40	2.20	202
479	548	22.3	12	442	598	4	0.30	2.30	3.40	2.20	201
479	548	22.3	12	442	598	4	0.30	2.30	3.40	2.20	197
505	605	22.3	12	448	672	5	0.30	2.30	3.40	2.20	353
505	605	22.3	12	448	672	5	0.30	2.30	3.40	2.20	352
505	605	22.3	12	448	672	5	0.30	2.30	3.40	2.20	353
497	599	22.3	12	448	674	5	0.38	1.80	2.60	1.70	436
495	596	22.3	12	448	674	5	0.38	1.80	2.60	1.70	428
495	596	22.3	12	448	674	5	0.38	1.80	2.60	1.70	436
525	643	22	12	456	724	6	0.35	1.90	2.90	1.80	550
525	643	22	12	456	724	6	0.35	1.90	2.90	1.80	551
525	643	22	12	456	724	6	0.35	1.90	2.90	1.80	546
492	553	16.7	8	462	578	3	0.17	4.00	5.90	4.00	101
492	553	16.7	8	462	578	3	0.17	4.00	5.90	4.00	101
507	585	22.3	8	468	622	5	0.22	3.00	4.60	2.80	186
507	585	22.3	8	468	622	5	0.22	3.00	4.60	2.80	179
507	585	22.3	8	468	622	5	0.22	3.00	4.60	2.80	185
507	585	22.3	8	468	622	5	0.22	3.00	4.60	2.80	178
502	569	22.3	12	468	626	5	0.30	2.30	3.40	2.20	251
502	569	22.3	12	468	626	5	0.30	2.30	3.40	2.20	251
502	569	22.3	12	468	626	5	0.30	2.30	3.40	2.20	245
522	626			468	692	5	0.30	2.30	3.40	2.20	375
522	626	22.3	12	468	692	5	0.30	2.30	3.40	2.20	372
517	618	22.3	12	468	692	5	0.37	1.80	2.70	1.80	436
517	618	22.3	12	468	692	5	0.37	1.80	2.70	1.80	455
548	675	22.3	12	472	578	6	0.35	1.90	2.90	1.80	611
548	675	22.3	12	472	578	6	0.35	1.90	2.90	1.80	578
504	540	16.7	7	472	566	2.5	0.17	4.00	5.90	4.00	77
504	540	16.7	7	472	566	2.5	0.17	4.00	5.90	4.00	82

Spherical Roller Bearing(CA)

d 460~480 mm

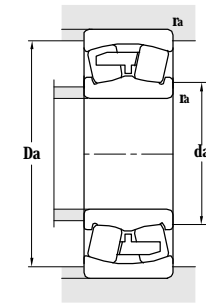
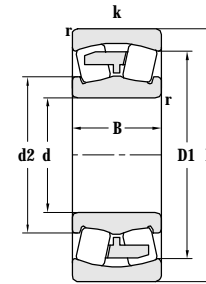
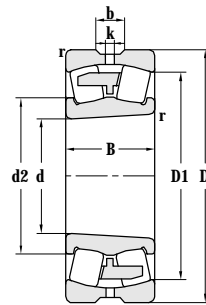
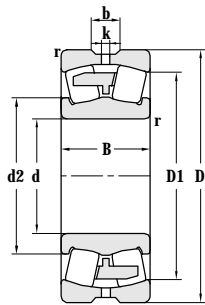

Principal dimensions				Basic load ratings		Limit speed ratings		Designations	
d	D	B	r _{min}	C _r	C _{0r}	Grease	Oil		
mm				kN		r/min			
460	620	118	4	2400	5000	500	900	23992CA/W33	
	620	110	4	2370	4750	430	530	23992X2CA/W33AYA1	
	650	120	4	430	5150	420	510	23992X3CA 23992X3CA/W33	
	680	163	6	3800	7140	500	850	23092CA 23092CA/W33	
	680	163	6	3800	7140	500	850	23092CAF3 23092CAF3/W33	
	680	163	6	3800	7140	500	850	23092CAF3	
	680	163	6	3800	7140	500	850	23092CAK 23092CAK/W33	
	680	218	6	4900	10200	340	430	24092CA/W33	
	680	218	6	4900	10200	340	430	24092CAF3/W33	
	680	218	6	4900	10200	340	430	24092CA/HCRW33	
	760	240	7.5	6300	11100	350	700	23192CA 23192CA/W33	
	760	240	7.5	6300	11100	350	700	23192CAK/W33	
	760	240	7.5	6300	11100	350	700	23192CAF3 23192CAF3/W33	
	760	240	7.5	6300	11100	350	700	23192CAF3/W33	
	760	300	7.5	7850	14400	160	200	24192CA/W33	
	760	300	7.5	7850	14400	160	200	24192CAK30/W33	
	760	300	7.5	7850	14400	160	200	24192CAF3/W33	
	830	296	7.5	8400	13600	350	500	23292CAF3/W33	
	479	790	258	7.5	5300	12100	300	380	231/479X2CAK1/W33YB2
	480	600	90	3	1350	3985	500	900	23896CA 23896CA/W33
650		128	5	2800	5725	500	900	23996CA/W33	
650		128	5	2800	5725	500	900	23996CAF1/W33 23996CAF3/W33	
650		128	5	2800	5725	500	900	23996CAK1 23996CAKF3	
650		128	5	2800	5725	500	900	23996CAF1/W33	
700		165	6	3800	6900	450	850	23096CA/W33	
700		165	6	3800	6900	450	850	23096CAK/W33	
700		165	6	3260	7530	400	500	23096F3 23096F3/W33	
700		218	6	5000	10400	340	430	24096CA/W33	
700		218	6	5000	10400	340	430	24096CAK30/W33	
790		248	7.5	6850	12000	350	700	23196CA/W33	
790		248	7.5	6850	12000	350	700	23196CAF1/W33X 23196CAF3/W33X	
790		248	7.5	6850	12000	350	700	23196CAK1/W33X 23196CAKF3/W33X	
790		248	7.5	6850	12000	350	700	23196CAK/W33	
790		308	7.5	8550	14900	240	320	24196CAF3/W33	

Other dimensions				Contact surface and chamfer dimensions			Calculation coefficient				Weight
d2	D1	b	k	da	Da	ra	e	Y1	Y2	Y0	
mm				mm	mm	mm	mm				kg
511	572	16.7	9	475	605	3	0.16	4.20	6.30	4.00	105
511	574	16.7	9	475	605	3	0.16	4.20	6.30	4.00	96.8
520	592	16.7	9	480	615	3	0.17	4.00	5.90	4.00	132
531	613	23.5	12	488	652	5	0.22	3.00	4.60	2.80	229
531	613	23.5	12	488	652	5	0.22	3.00	4.60	2.80	227
531	613			488	652	5	0.22	3.00	4.60	2.80	226
531	613	23.5	12	488	652	5	0.22	3.00	4.60	2.80	228
528	600	24	12	488	652	5	0.29	2.35	3.50	2.30	
528	600	24	12	488	652	5	0.29	2.35	3.50	2.30	304
528	600	24	12	488	652	5	0.29	2.35	3.50	2.30	308
557	660	22	8	496	724	6	0.30	2.30	3.40	2.20	442
557	660	22	8	496	724	6	0.30	2.30	3.40	2.20	437
557	660	22	8	496	724	6	0.30	2.30	3.40	2.20	440
557	660	22	8	496	724	6	0.30	2.30	3.40	2.20	435
540	639	22.3	8	496	724	6	0.37	1.80	2.70	1.80	461
540	639	22.3	8	496	724	6	0.37	1.80	2.70	1.80	460
540	639	22.3	8	496	724	6	0.37	1.80	2.70	1.80	459
566	698	22.3	10	496	794	6	0.35	1.90	2.90	1.80	698
578	683	22	12	516	754	6	0.31	2.20	3.30	2.20	497
523	563	13.9	7.5	500	580	2.5	0.13	5.36	7.98	5.24	60.4
532	596	16.7	10	502	628	4	0.18	3.80	5.60	3.60	126
532	596	16.7	10	502	628	4	0.18	3.80	5.60	3.60	125
532	596			504	628	4	0.18	3.80	5.60	3.60	121
532	596	16.7	10	504	628	4	0.18	3.80	5.60	3.60	121
552	634	22.3	12	504	678	5	0.21	3.20	4.80	3.20	215
552	634	22.3	12	504	678	5	0.21	3.20	4.80	3.20	203
553	625	22.3	12	504	678	5	0.23	2.90	4.40	2.80	247
542	618	22.3	12	504	678	5	0.28	2.40	3.60	2.50	285
542	618	22.3	12	504	678	5	0.28	2.40	3.60	2.50	290
578	687	22	12	516	754	6	0.30	2.30	3.40	2.20	520
578	687	22	12	516	754	6	0.30	2.30	3.40	2.20	516
578	687	22	12	516	754	6	0.30	2.30	3.40	2.20	485
578	687	22	12	516	754	6	0.30	2.30	3.40	2.20	489
568	673	22.3	8	513	759	6	0.37	1.80	2.70	1.80	582

Spherical Roller Bearing(CA)

d 480~530 mm

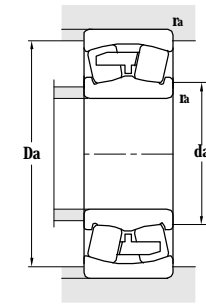
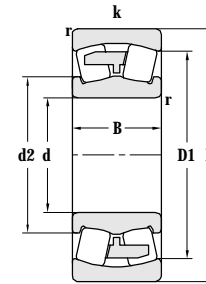
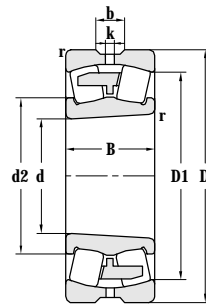
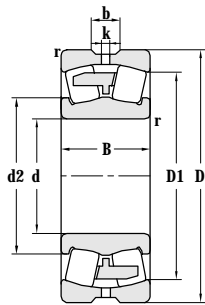

Principal dimensions				Basic load ratings		Limit speed ratings		Designations
d	D	B	r _{min}	C _r	C _{OR}	Grease	Oil	
mm				kN		r/min		
480	790	308	7.5	8550	14900	240	320	24196CAK30/W33
	790	308	7.5	8550	14900	240	320	24196CAK30F3/W33
	870	310	7.5	6750	15200	280	360	23296/W33
	870	310	7.5	6750	15200	280	360	23296F3
	870	310	7.5	9200	15200	300	450	23296CA/W33
	870	310	7.5	9200	15200	300	450	23296CAK 23296CAK/W33
	870	310	7.5	9200	15200	300	450	23296CAF3 23296CAF3/W33
	870	310	7.5	9200	15200	300	450	23296CAKF3 23296CAKF3/W33
500	620	90	3	1400	3800	420	520	238/500CA/W33 238/500CA/W20
	620	90	3	1400	3800	420	520	238/500CAK/W33
	670	128	5	2800	5900	450	900	239/500CA/W33
	670	128	5	2800	5750	450	900	239/500CAF1 239/500CAF1/W33
	670	128	5	2800	5750	450	900	239/500CAF3/W33
	670	128	5	2800	5750	450	900	239/500CAF1/W33YA1 239/500CAF3/W33YA1
	670	128	5	2800	5750	450	900	239/500CAK/W33
	720	167	6	4100	7700	450	800	230/500CAF3 230/500CAF3/W33
	720	167	6	4100	7900	450	800	230/500CA/W33
	720	167	6	4100	7700	450	800	230/500CAKF3 230/500CAKF3/W33
	720	167	6	4100	7700	450	800	230/500CAKF3/W33X
	720	167	6	4100	7700	450	800	230/500CAF3/HAW33X
	720	167	6	4100	7700	450	800	230/500CAKF3/HAW33X
	720	218	6	5200	10450	420	520	240/500CA/W33 240/500CA
	720	218	6	5200	10450	420	520	240/500CAK30/W33
	720	218	6	5200	10450	420	520	240/500CAF3/W33
	830	264	7.5	7550	13800	350	650	231/500CA/W33 231/500CAK/W33
	830	325	7.5	9300	16100	300	380	241/500CAK30/W33
	830	325	7.5	9300	16100	300	380	241/500CA/W33
	920	336	7.5	10500	17200	300	450	232/500CAF3/W33
920	336	7.5	10500	18600	300	450	232/500CAK/W33 232/500CA/W33	
530	650	90	3	1800	5350	400	500	238/530CAF1/W33
	650	118	3	1800	5350	380	480	248/530CA/W33 248/530CA/W20
	650	118	3	1800	5350	380	480	248/530CAK30/W33
	710	136	5	3100	6700	400	800	239/530CAF3/W33YA1
	710	136	5	3100	7100	400	800	239/530CA/W33

Other dimensions				Contact surface and chamfer dimensions			Calculation coefficient				Weight
d2	D1	b	k	da	Da	ra	e	Y1	Y2	Y0	
mm				mm	mm	mm	mm				kg
568	673	22.3	8	513	759	6	0.37	1.80	2.70	1.80	584
568	673	22.3	8	513	759	6	0.37	1.80	2.70	1.80	581
581	736	22.3	12	516	834	6	0.35	1.90	2.90	1.80	910
581	736			516	834	6	0.35	1.90	2.90	1.80	909
581	732	22.3	12	516	834	6	0.35	1.90	2.90	1.80	853
581	732			516	834	6	0.35	1.90	2.90	1.80	859
581	732	22.3	12	516	834	6	0.35	1.90	2.90	1.80	858
581	732	22.3	12	516	834	6	0.35	1.90	2.90	1.80	848
542	586	16.7	8	512	606	2.5	0.12	5.60	8.40	5.60	62
542	586	16.7	8	512	606	2.5	0.12	5.60	8.40	5.60	54
555	619	22.3	12	522	648	4	0.17	4.00	5.90	4.00	120
555	619	22.3	12	522	648	4	0.17	4.00	5.90	4.00	120
555	619	22.3	12	522	648	4	0.17	4.00	5.90	4.00	119
555	619	22.3	12	522	648	4	0.17	4.00	5.90	4.00	120
555	619	22.3	12	522	648	4	0.17	4.00	5.90	4.00	116
568	653	22.3	12	528	692	5	0.21	3.20	4.80	3.20	229
568	653	22.3	12	528	692	5	0.21	3.20	4.80	3.20	230
568	653	22.3	12	528	692	5	0.21	3.20	4.80	3.20	228
568	653	22.3	8	528	692	5	0.21	3.20	4.80	3.20	227
568	653	22.3	8	528	692	5	0.21	3.20	4.80	3.20	228
568	653	22.3	8	528	692	5	0.21	3.20	4.80	3.20	227
565	645	22.3	12	523	698	5	0.26	2.60	3.90	2.50	297
565	645	22.3	12	523	698	5	0.26	2.60	3.90	2.50	298
565	645	22.3	12	523	698	5	0.26	2.60	3.90	2.50	295
603	726	22.3	12	536	794	6	0.30	2.30	3.40	2.20	588
588	712	22.3	12	531	798	6	0.37	1.80	2.70	1.80	712
588	712	22.3	12	531	798	6	0.37	1.80	2.70	1.80	719
620	774	22.3	12	536	884	6	0.35	1.90	2.90	1.80	977
620	774	22.3	12	536	884	6	0.35	1.90	2.90	1.80	982
575	613	22.4	12	552	652	2.5	0.12	5.60	8.40	5.60	64.2
573	612	22	8	543	636	2.5	0.15	4.50	6.70	4.50	91
573	612	22	8	543	636	2.5	0.15	4.50	6.70	4.50	86
586	658	22.3	12	548	690	4	0.17	4.00	5.90	4.00	154
586	658	22.3	12	548	690	4	0.17	4.00	5.90	4.00	155

Spherical Roller Bearing(CA)

d 530~580 mm

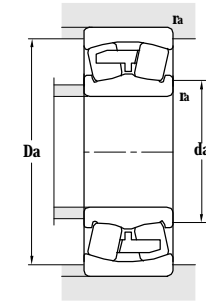
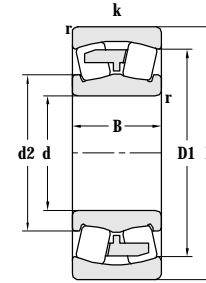
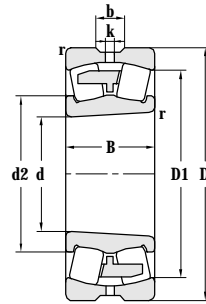
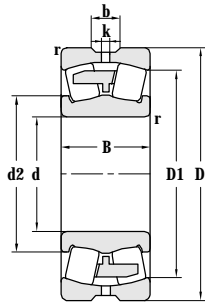

Principal dimensions	Basic load ratings		Limit speed ratings		Designations				
	d	D	C _r	C _{0r}					
	B	r _{min}	Grease	Oil					
mm	kN	r/min							
530	710	136	5	3100	7100	400	800	239/530CAK/W33	
	710	136	5	3100	7100	400	800	239/530CA/HCRW33	
	780	185	6	5000	10200	400	700	230/530CA	230/530CA/W33X
	780	185	6	5000	10200	400	700	230/530CAF3	230/530CAF3/W33X
	780	185	6	5000	10200	400	700	230/530CAK/W33	230/530CAK
	780	185	6	5000	10200	400	700	230/530CA/HCRW33	
	780	250	6	6350	12700	280	360	240/530CA/W33	
	780	250	6	6350	12700	280	360	240/530CA/HCRW33	
	780	250	6	6350	13200	280	360	240/530CAB/HCRW33	
	870	272	7.5	8050	15300	300	600	231/530CA/W33	
	870	272	7.5	8050	13300	300	600	231/530CAK/W33	
	870	335	7.5	10000	18300	190	280	241/530CA/W33	
	870	335	7.5	10000	18000	190	280	241/530CAK30/W33	
	980	335	9.5	11000	20300	250	400	232/530CAK30/W33	
560	750	140	5	3400	7200	400	800	239/560CAF1	239/560CAF3
	750	140	5	3400	7200	400	800	239/560CAF3/W33	239/560CA/W33
	820	195	6	5500	10500	400	800	230/560CA	230/560CAF3
	820	195	6	5500	10500	400	800	230/560CAF3/W33	230/560CA/W33
	820	195	6	5500	10500	400	800	230/560CAK/W33	230/560CAK30/W33
	820	195	6	5500	10500	400	800	230/560CAK30/W33	230/560CAK30/W33
	820	258	6	6950	13800	220	300	240/560CA/W33	240/560X3CA/C3W33-QL
	820	258	6	6950	13800	220	300	240/560CAK30/W33	
	920	280	7.5	9050	15900	300	550	231/560CA/W33	231/560CAF3/W33
	920	280	7.5	9050	15700	300	550	231/560CAK/W33	231/560CAK30/W33
	920	280	7.5	9050	15700	300	550	231/560CA/HCRW33	
	920	355	7.5	9500	20100	150	400	241/560CAF3/HCRW33	
	920	355	7.5	11400	20500	120	160	241/560CAF3K30/W33	241/560CAF3K30/HCW33
	920	355	7.5	11400	20500	120	160	241/560CA/W33	241/560CA/HCW33
	920	355	7.5	11400	20500	120	160	241/560CAK30/W33	241/560CAK30/HCW33
	920	355	7.5	10000	20000	120	160	241/560K30/W33	241/560/W33YA3
	1030	365	9.5	11150	21000	250	400	232/560CA/W33	
	1030	365	9.5	11150	21000	250	400	232/560CAK/W33	
580	780	130	5	3050	6800	220	300	26/580CAK3/W33	
	870	240	6	6400	1400	220	300	26/580CAK3/W33-1	

Other dimensions		Contact surface and chamfer dimensions			Calculation coefficient				Weight		
d2	D1	b	k	da	Da	ra	e	Y1		Y2	Y0
mm				mm	mm	mm	mm				kg
586	658	22.3	12	548	690	4	0.17	4.00	5.90	4.00	150
586	658	22.3	12	548	690	4	0.17	4.00	5.90	4.00	155
614	703	24	12	558	752	5	0.22	3.00	4.60	2.80	339
614	703	24	12	558	752	5	0.22	3.00	4.60	2.80	335
614	703	24	12	558	752	5	0.22	3.00	4.60	2.80	329
614	703	24	12	558	752	5	0.22	3.00	4.60	2.80	338
605	691	22.3	12	553	758	5	0.29	2.30	3.50	2.40	416
605	691	22.3	12	553	758	5	0.29	2.30	3.50	2.40	416
605	691	24	12	553	758	5	0.29	2.30	3.50	2.40	420
635	762	22.3	12	560	837	6	0.30	2.30	3.40	2.20	665
635	762	22.3	12	560	837	6	0.30	2.30	3.40	2.20	640
622	748	22.3	12	560	837	6	0.37	1.80	2.80	1.80	813
622	748	22.3	12	560	837	6	0.37	1.80	2.80	1.80	825
656	818	22.3	12	565	932	8	0.36	1.87	2.79	1.83	1200
621	693			582	728	4	0.16	4.20	6.30	4.00	177
621	693	22.3	12	582	728	4	0.16	4.20	6.30	4.00	178
644	741			588	792	5	0.22	3.14	4.67	3.07	363
644	741	22.3	9	588	792	5	0.22	3.14	4.67	3.07	362
644	741	22.3	9	588	792	5	0.22	3.14	4.67	3.07	351
644	741	22.3	9	588	792	5	0.22	3.14	4.67	3.07	353
640	721	22.3	12	585	798	5	0.28	2.40	3.60	2.50	471
640	721	22.3	12	585	798	5	0.28	2.40	3.60	2.50	464
677	803	22.3	12	596	884	6	0.30	2.30	3.40	2.20	756
677	803	22.3	12	596	884	6	0.30	2.30	3.40	2.20	745
677	8.3	22.3	12	596	884	6	0.30	2.30	3.40	2.20	756
634	796	22.3	12	596	884	6	0.37	1.80	2.80	1.80	964
634	796	22.3	12	596	884	6	0.37	1.80	2.80	1.80	950
634	796	22.3	12	596	884	6	0.37	1.80	2.80	1.80	973
634	796	22.3	12	596	884	6	0.37	1.80	2.80	1.80	955
662	777	22.3	12	596	884	6	0.37	1.80	2.80	1.80	956
705	877	22.3	12	600	990	8	0.35	1.90	2.90	1.80	1380
705	877	22.3	12	600	990	8	0.35	1.90	2.90	1.80	1340
646	726	22.3	12	611	750	4					176
671	774	22.3	12	622	735	5					512

Spherical Roller Bearing(CA)

d 600~670 mm

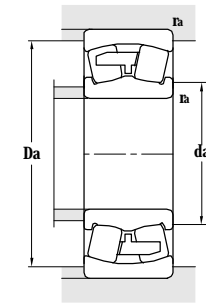
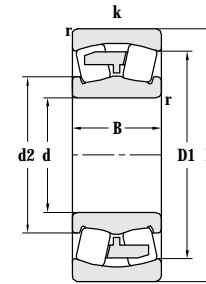
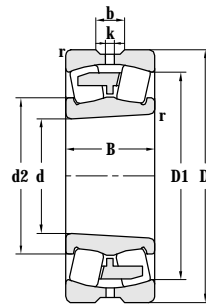
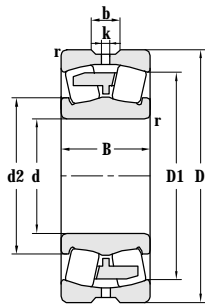

Principal dimensions				Basic load ratings		Limit speed ratings		Designations
d	D	B	r _{min}	C _r	C _{0r}	Grease	Oil	
mm				kN		r/min		
600	800	150	5	3750	8400	400	700	239/600CA 239/600CA/W33
	800	150	5	3750	8400	400	700	239/600CAK/W33
	800	200	5	4250	11200	320	400	249/600CAF1/W33 249/600CAF3/W33
	870	200	6	5900	11600	350	650	230/600CAF3 230/600CAF3/W33
	870	200	6	5900	11600	350	650	230/600CAK 230/600CAK/W33
	870	200	6	5900	11600	350	650	230/600CAKF3
	870	200	6	5900	11600	350	650	230/600CA/W33
	870	272	6	8100	16500	300	500	240/600CA/W33
	870	272	6	8100	16500	300	500	240/600CA/HCRW33
	870	272	6	8100	16500	300	500	240/600/W33
	980	300	7.5	10100	18800	300	500	231/600CAF3/W33
	980	375	7.5	10900	22400	300	500	241/600CA
	980	375	7.5	10900	22400	300	500	241/600CA/HCW33 241/600CA/HCRW33
	980	375	7.5	10900	22400	300	500	241/600CAK30/W33
	980	375	7.5	10900	22400	300	500	241/600CA/W33 241/600CAF3/W33X
	1090	388	9.5	13100	25000	250	350	232/600CAKF3/YA2W33 232/600CAK/W33
628	920	212	7.5	5600	12800	260	340	230/628CAF3/W33
630	780	112	4	2200	6300	300	400	238/630CAF3/W33
	820	112	4	2200	6300	270	350	238/670CA/W33
	820	112	4	2200	6300	270	350	238/670CAK/W33
	820	150	4	3100	9600	270	350	248/670CA/W33
	850	212	7.5	4750	12200	240	330	249/630/2CAF3/W33
	850	165	6	4500	9750	300	600	239/630CA 239/630CAK/W33
	850	165	6	4500	9750	300	600	239/630CA/W33
	920	212	7.5	6500	12800	300	600	230/630CA/W33
	920	212	7.5	6500	12800	300	600	230/630CAF3 230/630CAF3/W33
	920	290	7.5	7350	17100	220	300	240/630/W33
	1030	315	7.5	10200	20200	200	500	231/630CA/W33
	1030	315	7.5	10200	20200	200	500	231/630CAK/W33
	1030	400	7.5	12000	25600	160	210	241/630CA/W33 241/630CAF3/W33
	1030	400	7.5	12000	25600	160	210	241/630CAF3/HBW33
	1030	400	7.5	12000	25600	160	210	241/630CAK30/W33
670	820	112	4	2410	6600	300	600	238/670CA/W33

Other dimensions				Contact surface and chamfer dimensions			Calculation coefficient				Weight
d2	D1	b	k	da	Da	ra	e	Y1	Y2	Y0	
mm				mm	mm	mm	mm				
668	742	22.3	12	622	778	4	0.17	4.00	5.90	4.00	220
668	742	22.3	12	622	778	4	0.17	4.00	5.90	4.00	213
666	728	22.3	12	622	760	4	0.22	3.00	4.60	2.80	287
685	787	22.3	9	628	842	5	0.22	3.00	4.60	2.80	442
685	787	22.3	9	628	842	5	0.22	3.00	4.60	2.80	420
685	787			628	842	5	0.22	3.00	4.60	2.80	430
685	787	22.3	9	628	842	5	0.22	3.00	4.60	2.80	431
682	770	22.3	12	628	850	5	0.30	2.30	3.40	2.80	551
682	770	22.3	12	628	850	5	0.30	2.30	3.40	2.80	551
680	770	22.3	12	628	850	5	0.30	2.30	3.40	2.20	550
717	855	22.3	12	660	996	6	0.29	2.30	3.50	2.40	894
709	827	22	8	636	944	6	0.36	1.90	2.82	1.85	1151
709	827	22	8	636	944	6	0.36	1.90	2.82	1.85	1150
709	827	22	8	636	944	6	0.36	1.90	2.82	1.85	1134
709	827	22	8	636	944	6	0.36	1.90	2.82	1.85	1151
750	920			700	1000	8	0.35	1.93	2.88	1.80	1557
721	831	22.3	9	666	884	6	0.21	3.20	4.80	3.20	481
682	738	16.7	9	645	765	3	0.12	5.60	8.40	5.60	123
722	778	16.7	9	686	805	3	0.11	6.10	9.10	6.30	136
722	778	16.7	9	686	805	3	0.11	6.10	9.10	6.30	128
716	771	16.7	9	686	805	3	0.16	4.20	6.30	4.00	315
703	774	22.3	12								355
705	786	22.3	12	658	822	5	0.17	4.00	5.90	4.00	292
705	786	22.3	12	658	822	5	0.17	4.00	5.90	4.00	290
721	831	22.3	9	666	884	6	0.21	3.20	4.80	3.20	470
721	831	22.3	9	666	884	6	0.21	3.20	4.80	3.20	471
722	815	22.3	10	666	884	6	0.30	2.30	3.40	2.20	661
756	918	22.3	12	668	996	6	0.30	2.30	3.40	2.20	1040
756	918	22.3	12	668	996	6	0.30	2.30	3.40	2.20	1020
736	885	22.3	12	662	996	6	0.37	1.80	2.70	1.80	1440
736	885	22.3	12	662	996	6	0.37	1.80	2.70	1.80	1330
736	885	22.3	12	662	996	6	0.37	1.80	2.70	1.80	1400
721	778	16.7	9	693	805	3					128

Spherical Roller Bearing(CA)

d 670~710 mm

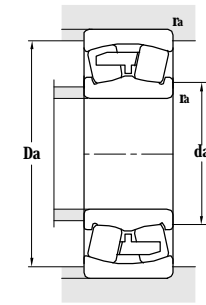
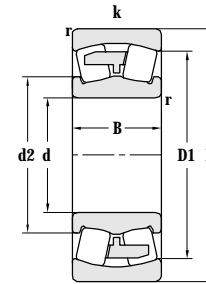
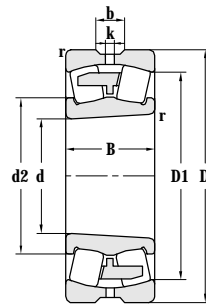
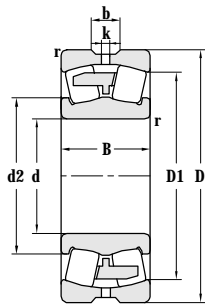

Principal dimensions				Basic load ratings		Limit speed ratings		Designations
d	D	B	r _{min}	C _r	C _{0r}	Grease	Oil	
mm				kN		r/min		
670	900	170	6	4850	10600	300	600	239/670CAF3/W33 239/670X1CAW33YA3
	980	230	7.5	7400	14200	300	500	230/670CAF3 230/670CAF3/W33
	980	230	7.5	7400	15000	300	500	230/670CAKF3/W33
	980	230	7.5	7400	14200	300	500	230/670CA/W33
	980	308	7.5	9700	19900	250	450	240/670CA 240/670CA/W33
	1090	336	7.5	10800	22700	200	450	231/670CA/W33
	1090	336	7.5	10800	21200	200	450	231/670CAK/W33
	1090	412	7.5	14000	31500	150	200	241/670CA/W33 241/670CA/W33YA3
	1090	412	7.5	14000	31500	150	200	241/670CAK30/W33
	1220	438	12	15600	30500	200	350	232/670CA/W33 232/670CA/HCW33
	1220	438	12	15600	30500	160	350	232/670CAK/W33
680	980	160	6	4900	9950	300	500	26/680CAF3/W33
690	950	230	7.5	5930	14270	250	450	206/690CA/W33-1
	990	180	6	5500	11800	220	310	206/690CAF3/W33
700	950	180	6	5000	11900	220	300	206/700CAF3/W33
710	870	118	4	2680	7500	260	350	238/710CAF3/W33
	950	180	6	5400	12000	300	550	239/710CAF1/W33 239/710CAF3/W33
	950	180	6	5400	12000	250	310	239/710CA/W33
	950	243	6	6600	15100	250	450	249/710CAF1/W33X
	1030	200	7.5	6500	14000	300	500	220/710X2CAF3/C9W33
	1030	200	7.5	6500	14000	300	500	220/710X2CAF3/C9W33
	1030	236	7.5	8050	16200	300	500	230/710CAF3/W33
	1030	236	7.5	8050	16200	300	500	230/710CAKF3/W33
	1030	236	7.5	8050	15700	300	500	230/710/W33
	1030	315	7.5	8900	21600	180	250	240/710CA/W33
	1030	315	7.5	8900	21600	180	250	240/710CAK30/W33
	1150	345	9.8	11800	25200	200	400	231/710CA/W33
	1150	345	9.8	11800	25200	200	400	231/710CAK/W33
	1150	438	9.5	14400	30800	90	120	241/710CAF1/W33 241/710CAF3/W33
	1150	438	9.5	14400	30800	90	120	241/710CA/W33
	1150	438	9.5	14400	30800	90	120	241/710CAK/W33
	1150	438	9.5	13200	31000	105	140	241/710K30/HCW33

Other dimensions				Contact surface and chamfer dimensions			Calculation coefficient				Weight
d2	D1	b	k	da	Da	ra	e	Y1	Y2	Y0	
mm				mm	mm	mm	mm				
743	831	22.3	12	692	876	5	0.17	4.00	5.90	4.00	321
760	885	22.3	12	706	944	6	0.22	3.00	4.60	3.20	601
760	885	22.3	12	706	944	6	0.22	3.00	4.60	3.20	596
760	885	22.3	12	706	944	6	0.22	3.00	4.60	3.20	604
760	866	22.3	12	700	952	6	0.28	2.40	3.60	2.50	807
801	958	22.3	12	700	1056	6	0.30	2.30	3.40	2.20	1256
801	958	22.3	12	700	1056	6	0.30	2.30	3.40	2.20	1240
786	934	22.3	12	705	1056	6	0.36	1.87	2.79	1.83	1530
786	934	22.3	12	705	1056	6	0.36	1.87	2.79	1.83	1507
832	1027	22.3	12	718	1170	10	0.35	1.90	2.90	1.80	2320
832	1027	22.3	12	718	1170	10	0.35	1.90	2.90	1.80	2250
774	906	22.3	12	708	950	5					406
773	868		12	725	915	6					489
780	907	22.3	12	705	975	5	0.16				461
780	877	13.3	12	715	935	5	0.16				378
761	824	22.3	12	725	855	3	0.11	6.10	9.10	6.30	156
787	882	22.3	12	733	927	5	0.17	4.00	5.90	4.00	364
787	882	22.3	12	733	927	5	0.17	4.00	5.90	4.00	367
791	864	22.3	12	733	927	5	0.22	3.00	4.60	2.80	500
802	944	22.3	12	746	994	6					566
808	939	22.3	12								
814	939	22.3	12	746	994	6	0.21	3.20	4.80	3.20	669
814	939	22.3	12	746	994	6					649
814	939	22.3	12	746	994	6	0.21	3.20	4.80	3.20	580
806	918	22.3	12	738	1002	6	0.27	2.50	3.70	2.50	910
806	918	22.3	12	738	1002	6	0.27	2.50	3.70	2.50	893
851	1016	22.3	12	750	1110	8	0.28	2.40	3.60	2.50	1480
851	1016	22.3	12	750	1110	8	0.28	2.40	3.60	2.50	1430
838	982	22.3	12	754	1106	8	0.35	1.90	2.90	1.80	1791
838	982	22.3	12	754	1106	8	0.35	1.90	2.90	1.80	1801
838	982	22.3	12	754	1106	8	0.35	1.90	2.90	1.80	1761
836	974	23.5	12.5	754	1106	8	0.38	1.80	2.60	1.70	1800

Spherical Roller Bearing(CA)

d 800~900 mm

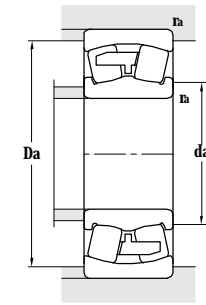
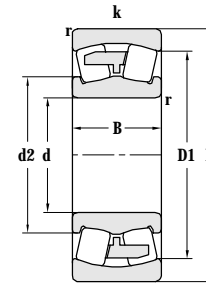
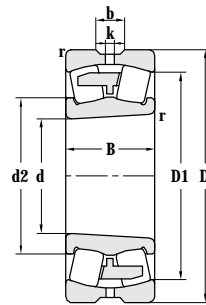
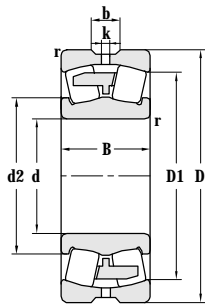

Principal dimensions				Basic load ratings		Limit speed ratings		Designations
d	D	B	r _{min}	C _r	C _{0r}	Grease	Oil	
mm				kN		r/min		
800	1280	375	9.5	14350	30550	150	350	231/800CA/W33
	1280	375	9.5	14350	30550	150	350	231/800CAK/W33
	1280	475	9.5	17500	38400	130	170	241/800CAF1/W33 241/800CAF3/W33
	1280	475	9.5	17500	38400	130	170	241/800CAK30/W33
	1420	488	15	19900	41000	100	150	232/800CAK30/W33
	1420	488	15	19900	41000	100	150	232/800CAKF3/W33
850	1030	136	5	3400	10000	180	250	238/850CA/W33
	1030	136	5	3400	10000	180	250	238/850CAK/W33
	1120	200	6	5800	15100	250	450	239/850CA/W33
	1120	200	6	5800	15100	250	450	239/850CAK/W33
	1120	272	6	7920	22100	200	350	249/850CA/W33 249/850CAF3/W33
	1120	272	6	7920	22100	200	350	249/850CAK30/W33
	1220	272	7.5	9050	22500	200	400	230/850CAF1
	1220	272	7.5	9700	22500	200	400	230/850CAKF1 230/850CAKF3
	1220	272	7.5	9950	23000	200	400	230/850CAF3/W33
	1220	365	7.5	12000	29900	160	200	240/850CAF1/W33X 240/850CAF1YA1
	1220	365	7.5	12000	29900	160	200	240/850CAF1/W33 240/850CAF1
	1220	365	7.5	12000	29900	160	200	240/850CAF3/W33X 240/850CAF3YA1
	1220	365	7.5	12000	29900	160	200	240/850CA/W33
	1220	365	7.5	12000	29900	160	200	240/850X2CAF3/W33X
	1220	365	7.5	12000	29900	160	200	240/850CAF3/W33 240/850CAF3
	1360	400	12	15600	33450	150	350	231/850CA/W33
	1360	400	12	15600	33450	150	350	231/850CAK/W33
	1360	500	12	19200	42700	105	140	241/850CA/W33
1360	500	12	19200	42700	105	140	241/850CA30K/W33	
884	1320	365	7.5	12900	28900	110	150	240/884/HCC9YA1 240/884F3/HCC9YA1
900	1090	190	5	4900	15500	210	375	248/900CA/W33
	1180	206	6	6250	16490	200	400	239/900CAF1/W33 239/900CAF3/W33
	1180	206	6	6250	16490	200	400	239/900CA/C3W33-QL 239/900CA/W33
	1180	206	6	6250	16490	200	400	239/900CAKF3/W33
	1270	365	7.5	11400	28400	160	210	240/900X3/HCC 240/900X3/HCYA3
	1270	365	7.5	11400	28400	160	210	240/900X3/W33
	1270	365	7.5	11400	28400	160	210	240/900X3/HCC9YA1

Other dimensions				Contact surface and chamfer dimensions			Calculation coefficient				Weight
d2	D1	b	k	da	Da	ra	e	Y1	Y2	Y0	
mm				mm	mm	mm	mm				kg
948	1140	22.3	12	842	1238	8	0.28	2.40	3.60	2.50	1960
948	1140	22.3	12	842	1238	8	0.28	2.40	3.60	2.50	1900
938	1102	22.3	12	842	1238	8	0.35	1.90	2.90	1.80	2350
938	1102	22.3	12	842	1238	8	0.35	1.90	2.90	1.80	2313
989	1198	22.3	12	899	1328	14	0.35	2.80	1.90	1.90	3419
989	1198	22.3	12	918	1328	14	0.35	2.80	1.90	1.90	3301
910	980	22.3	12	866	1012	4	0.11	6.10	9.10	6.30	232
910	980	22.3	12	866	1012	4	0.11	6.10	9.10	6.30	236
938	1045	22.3	12	872	1097	5	0.16	4.20	6.30	4.00	570
938	1045	22.3	12	872	1097	5	0.16	4.20	6.30	4.00	550
938	1028	22.3	12	872	1097	5	0.22	3.00	4.60	2.80	750
938	1028	22.3	12	872	1097	5	0.22	3.00	4.60	2.80	730
954	1108			886	1184	6	0.20	3.40	5.00	3.20	1074
954	1108			886	1184	6	0.20	3.40	5.00	3.20	1070
954	1108	22.3	12	886	1184	6	0.20	3.40	5.00	3.20	1073
956	1086	22.3	12	886	1184	6	0.27	2.50	3.70	2.50	1410
956	1086	22.3	12	886	1184	6	0.27	2.50	3.70	2.50	1410
956	1086	22.3	12	886	1184	6	0.27	2.50	3.70	2.50	1410
956	1086	22.3	12	886	1184	6	0.27	2.50	3.70	2.50	1416
956	1086	22.3	12	886	1184	6	0.27	2.50	3.70	2.50	1275
956	1086	22.3	12	886	1184	6	0.27	2.50	3.70	2.50	1410
1008	1204	22.3	12	898	1312	10	0.28	2.40	3.60	2.50	2260
1008	1204	22.3	12	898	1312	10	0.28	2.40	3.60	2.50	2180
986	1180	22.3	12	898	1312	10	0.35	1.90	2.90	1.80	2750
986	1180	22.3	12	898	1312	10	0.35	1.90	2.90	1.80	2720
1038	1184	24	12	936	1258	6	0.28	2.40	3.60	2.50	1811
963	1031	22.3	12	918	1073	4	0.14	4.80	7.20	4.50	370
988	1096	22.3	12	928	1150	5	0.15	4.50	6.70	4.50	611
988	1096	22.3	12	928	1150	5	0.15	4.50	6.70	4.50	616
988	1096	22.3	12	928	1150	5	0.15	4.50	6.70	4.50	591
1007	1139	24	12	936	1236	6	0.28	2.40	3.60	2.50	1434
1007	1139	24	12	936	1236	6	0.28	2.40	3.60	2.50	1434
1007	1139	24	12	936	1236	6	0.28	2.40	3.60	2.50	1434

Spherical Roller Bearing(CA)

d 900~1000 mm

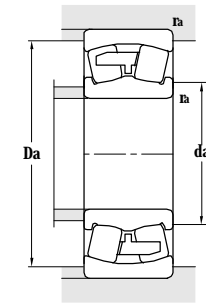
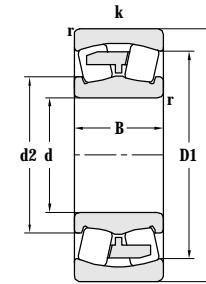
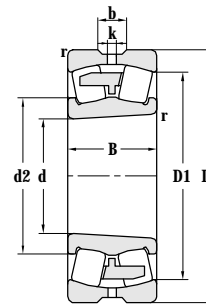
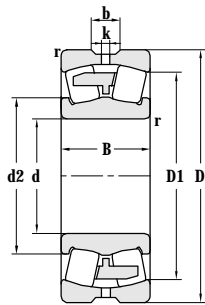

Principal dimensions				Basic load ratings		Limit speed ratings		Designations	
d	D	B	r _{min}	C _r	C _{0r}	Grease	Oil		
mm				kN		r/min			
900	1280	280	7.5	9800	22500	200	350	230/900CA/W33	
	1280	280	7.5	10100	23300	200	350	230/900CAF3/W33	
	1280	280	7.5	9600	22000	200	350	230/900CAK/W33	
	1280	375	7.5	13300	34000	140	190	240/900CA/W33	
	1280	375	7.5	10000	28000	150	190	240/900/W33	
	1280	480	7.5	15800	40400	140	170	240/900X2CA/C3W33-QL	
	1270	365	7.5	10800	26600	140	170	240/900X3/W33	
	1270	365	7.5	9900	28400	140	170	240/900X3/HC	
	1270	365	7.5	11800	29700	140	170	240/900X3F3/HCR 240/900X3F3/HCRYA3	
	1270	365	7.5	11800	29700	140	170	240/900X3/HCC9YA1	
	1320	365	7.5	10500	27600	130	170	240/900X3/HCC9-1	
	1420	515	12	20300	46500	95	140	241/900CA/W33	
	1420	515	12	20300	46500	95	140	241/900CAK/W33	
	1420	515	12	20300	46500	95	140	241/900CAF3/W33	
	1420	515	12	20300	46500	95	140	241/900CAK30/W33 241/900CAK30F3/W33	
	1580	515	15	23600	49000	90	110	232/900CAK30/W33	
	1580	515	15	23600	49000	90	110	232/900CAK30F3/W33	
	950	1250	224	7.5	7350	19000	200	400	239/950CA/W33
1250		300	7.5	8900	25200	150	300	249/950CA/W33	
1250		300	7.5	8900	25200	150	300	249/950CAK30/W33	
1360		300	7.5	11600	27650	150	350	230/950CAF3/W33	
1360		412	7.5	14600	39000	125	160	240/950CA/W33	
1360		412	7.5	14000	37000	125	160	240/950CAK30/W33	
1500		438	12	18500	41600	90	130	231/950CA	
1500		545	7.5	22700	52200	90	120	241/950CA/W33	
1500		545	7.5	22700	52200	90	120	241/950CAK30/W33	
1000		1220	165	6	4400	13600	150	300	238/1000CAKF1A/W20 238/1000CAKF3A/W20
		1220	165	6	4580	13600	150	300	238/1000CA/C3W33-QL
		1320	315	7.5	10400	29000	150	300	249/1000CA/W33
	1320	315	7.5	10400	29000	150	300	249/1000CAK30/W33	
	1420	260	7.5	10600	24000	150	170	220/1000X2CAF3/W33	
	1420	308	7.5	12700	30500	150	175	230/1000CAF1/W33 230/1000CAF3/W33	
	1420	412	7.5	14600	40500	110	150	240/1000CAF3/W33	
	1420	412	7.5	15600	40000	110	150	240/1000/W33	

Other dimensions				Contact surface and chamfer dimensions			Calculation coefficient				Weight
d2	D1	b	k	da	Da	ra	e	Y1	Y2	Y0	
mm				mm			mm				kg
1024	1175	22.3	12	928	1250	6	0.20	3.40	5.00	3.20	1220
1024	1175	22.3	12	928	1250	6	0.20	3.40	5.00	3.20	1168
1024	1175	22.3	12	928	1250	6	0.20	3.40	5.00	3.20	1180
1010	1136	22.3	12	936	1244	6	0.26	2.60	3.90	2.50	1570
1008	1136	24	12	936	1244	6	0.26	2.60	3.90	2.50	1520
1000	1136	25	25	936	1244	6	0.26	2.60	3.90	2.50	1976
1139	1007	24	12	850	1220	6					1440
1007	1139	24	12	850	1220	6					1434
1139	1007	24	12	850	1220	6					1434
1139	1007	24	12	850	1220	6					1434
1021	1184	24	12	940	1282	6	0.26	2.60	3.90	2.50	1730
1042	1233	22.3	12	948	1372	10	0.35	1.90	2.90	1.80	3060
1042	1233	22.3	12	948	1372	10	0.35	1.90	2.90	1.80	3400
1042	1233	22.3	12	948	1372	10	0.35	1.90	2.90	1.80	3042
1042	1233	22.3	12	948	1372	10	0.35	1.90	2.90	1.80	3360
1114	1354		20	960	1500	14					4360
	1354		20	960	1500	14					
1046	1163	22.3	12	978	1222	6	0.15	4.50	6.70	4.50	759
1048	1149	22.3	12	978	1222	6	0.21	3.20	4.80	3.20	1030
1048	1149	22.3	12	978	1222	6	0.21	3.20	4.80	3.20	1000
1075	1234	22.3	12	978	1330	6	0.20	3.40	5.00	3.20	1440
1072	1212	22.3	12	978	1330	6	0.27	2.50	3.70	2.50	1971
1072	1212	22.3	12	978	1330	6	0.27	2.50	3.70	2.50	2000
1121	1319										2997
1104	1304	22.3	12	998	1452	6	0.35	1.90	2.90	1.80	3600
1104	1304	22.3	12	998	1452	6	0.35	1.90	2.90	1.80	3540
1069	1154		9	972	1260	5	0.11	5.92	8.81	5.78	402
1069	1154	22.3	12	972	1260	5	0.11	5.92	8.81	5.78	407
1108	1211	22.3	12	965	1291	6	0.21	3.20	4.80	3.20	1188
1108	1211	22.3	12	965	1291	6	0.21	3.20	4.80	3.20	1200
1129	1304	22.3	12	965	1380	6					1332
1140	1303	22.3	12	965	1392	6	0.19	3.60	5.30	3.60	1590
1130	1267	22.3	12	965	1392	6	0.26	2.60	3.90	2.50	2130
1127	1273	22.3	12	965	1385	6					2150

Spherical Roller Bearing(CA)

d 1000~1180 mm

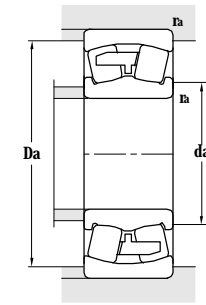
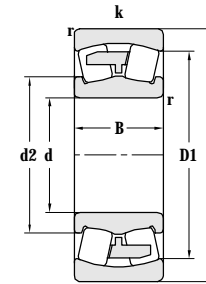
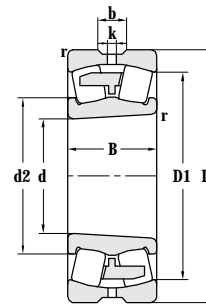
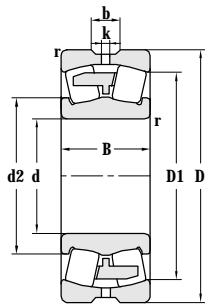

Principal dimensions				Basic load ratings		Limit speed ratings		Designations
d	D	B	r _{min}	C _r	C _{Or}	Grease	Oil	
mm				kN		r/min		
1000	1580	462	12	20300	45600	95	130	231/1000CA/W33
	1580	462	12	20300	45600	95	130	231/1000CAK/W33
	1580	580	12	25300	58900	85	110	241/1000CA/W33
	1580	580	12	25300	58900	85	110	241/1000CAK30/W33
1060	1280	165	6	4500	14200	150	195	238/1060CA/W33
	1280	165	6	4500	14200	150	195	238/1060CAK/W33
	1280	218	6	5800	19000	125	160	248/1060CA/W33
	1280	218	6	5800	19000	125	160	248/1060CAK30/W33
	1400	250	7.5	9870	26300	145	170	239/1060CAF3/W33
	1400	250	7.5	9000	24700	145	170	239/1060CAF3/W33X
	1400	250	7.5	9870	26300	145	170	239/1060CAKF3/W33
	1400	260	7.5	9450	25400	145	170	239/1060X2CAF3/W33
	1400	335	7.5	11150	31500	145	170	249/1060CAF3/W33
	1400	335	7.5	11150	31500	120	150	249/1060CA/W33
	1400	335	7.5	11150	31500	120	150	249/1060CAK30/W33
	1500	325	9.5	13380	32300	120	160	230/1060CA/W33
	1500	325	9.5	13100	32300	120	160	230/1060CAK/W33
	1500	438	9.5	17000	44100	110	150	240/1060F3/HCW33
	1500	438	9.5	17000	44100	110	150	240/1060F3/W33
	1500	438	9.5	17200	45000	100	145	240/1060CA/W33
1500	530	9.5	20000	52500	100	145	240/1060X2CAF3/W33	
1500	438	9.5	17200	45000	100	145	240/1060CAK30/W33	
1120	1360	243	6	6900	22800	105	250	248/1120CA/W33
	1360	243	6	6900	22800	105	250	248/1120CAK30/W33
	1460	335	7.5	12000	35200	100	250	249/1120CAF3/W33
	1580	345	9.5	15000	38100	100	200	230/1120CAF3/W33X
	1580	462	9.5	18100	48500	100	200	240/1120CA/W33
	1580	462	9.5	17800	47500	100	200	240/1120CAK30/W33
	1750	630	15	29500	72000	70	80	241/1120K30F3/W33X
1180	1420	180	6	5500	17600	150	190	238/1180CAK1AW20
	1420	180	6	5500	17600	150	190	238/1180CAF3AW20
	1420	243	6	7300	25600	130	160	248/1180CA/W33

Other dimensions				Contact surface and chamfer dimensions			Calculation coefficient				Weight
d2	D1	b	k	da	Da	ra	e	Y1	Y2	Y0	
mm				mm			mm				kg
1181	1404	22.3	12	965	1532	10	0.28	2.40	3.50	2.50	3520
1181	1404	22.3	12	965	1532	10	0.28	2.40	3.50	2.50	3410
1160	1372	22.3	12	965	1532	10	0.35	1.90	2.90	1.80	4350
1160	1372	22.3	12	965	1532	10	0.35	1.90	2.90	1.80	4260
1134	1218	22.3	12	1082	1258	5	0.11	6.10	9.10	6.30	440
1134	1218	22.3	12	1082	1258	5	0.11	6.10	9.10	6.30	425
1136	1211	22.3	12	1082	1258	5	0.14	4.80	7.20	4.50	576
1136	1211	22.3	12	1082	1258	5	0.14	4.80	7.20	4.50	565
1170	1304	22.3	12	1090	1365	6	0.16	4.20	6.30	4.00	1075
1170	1304	22.3	12	1090	1365	6	0.16	4.20	6.30	4.00	1041
1170	1304	22.3	12	1090	1365	6	0.16	4.20	6.30	4.00	1041
1170	1300	22.3	12	1090	1365	6					1111
1170	1304	22.3	12	1090	1365	6	0.16	4.20	6.30	4.00	1441
1164	1285	22.3	12	1090	1365	6	0.21	3.20	4.80	3.20	1420
1164	1285	22.3	12	1090	1365	6	0.21	3.20	4.80	3.20	1390
1200	1377	22.3	12	1093	1465	8	0.19	3.60	5.30	3.60	2300
1200	1377	22.3	12	1093	1465	8	0.19	3.60	5.30	3.60	2210
1185	1339	22.3	12	1093	1465	8	0.27	2.50	3.70	2.50	2500
1185	1339	22.3	12	1093	1465	8	0.27	2.50	3.70	2.50	2500
1190	1339	22.3	12	1093	1465	8	0.26	2.60	3.90	2.50	2540
1190	1339	22.3	12	1093	1465	8	0.26	2.60	3.90	2.50	3010
1190	1339	22.3	12	1093	1465	8	0.26	2.60	3.90	2.50	2540
1198	1278	22.3	12	1140	1335	5	0.15	4.50	6.70	4.50	740
1198	1278	22.3	12	1140	1335	5	0.15	4.50	6.70	4.50	725
1235	1348	22.3	12	1146	1431	6	0.20	3.40	5.00	3.20	1500
1286	1443	40	25	1155	1545	8	0.19	3.40	5.00	3.20	2210
1268	1421	22.3	12	1155	1545	8	0.26	2.60	3.90	2.50	2940
1268	1421	22.3	12	1155	1545	8	0.26	2.60	3.90	2.50	2850
1297	1509		16								5610
1254	1349		9	1180	1450	5	0.11	6.28	9.35	6.14	577
1254	1349		9	1180	1450	5	0.11	6.28	9.35	6.14	580
1250	1344	22.3	12	1180	1450	5	0.14	4.80	7.20	4.50	790

Spherical Roller Bearing(CA)

d 1180~2000 mm

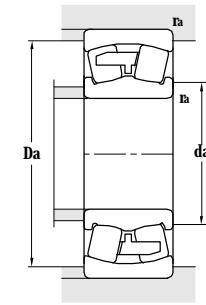
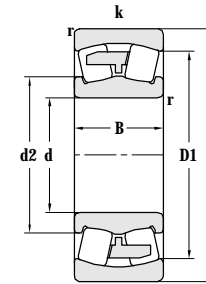
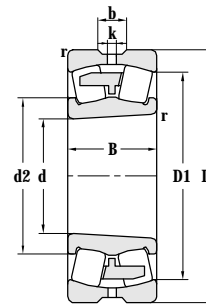
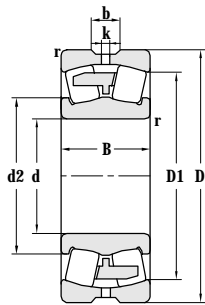

Principal dimensions				Basic load ratings		Limit speed ratings		Designations
d	D	B	r _{min}	C _r	C _{OR}	Grease	Oil	
mm				kN		r/min		
1180	1420	243	6	7300	25600	130	160	248/1180CAK30/W33
	1540	272	7.5	10750	30000	110	150	239/1180CAKF3/W33X 239/1180CAKF1/W33X
	1540	272	7.5	10750	30000	110	150	239/1180CAF3/W33 239/1180CAF3/W33
	1540	355	7.5	13900	40000	110	150	249/1180CAF1/W33X 249/1180CAF3/W33X
	1540	355	7.5	13900	40000	110	150	249/1180CAK30F3/W33
	1660	355	9.5	15000	36000	110	150	230/1180CA/HCRW33X 230/1180/HCRW33X
	1660	355	9.5	10700	29600	110	150	230/1180CAF3/W33X
	1660	355	9.5	10700	29600	110	150	230/1180F3/HCRC9W33X
1200	1500	280	7.5	10100	31000	130	150	206/1200CA/W33
1250	1750	375	9.5	17350	43650	100	120	230/1250CA/W33
	1750	375	9.5	17350	43650	100	120	230/1250CAK/W33
1320	1600	280	6	9820	33500	85	120	248/1320CA/W33
	1600	280	6	9300	31800	85	120	248/1320CA30/W33
	1720	400	7.5	15600	46500	80	110	249/1320CA/W33 249/1320CAF3/W33
	1720	400	7.5	16400	49000	80	110	249/1320CAF3/HBW33 249/1320CAF3/W33
	1720	400	7.5	15300	46500	80	110	249/1320CAK30/W33
	1850	530	12	23200	63300	70	85	240/1320CAF3/W33T
1350	1650	315	7.5	11600	39500	80	110	206/1350CAF3/W33
1400	1820	425	9.5	20000	58500	70	85	249/1400CAF3/W33
1440	1760	315	7.5	11500	39700	70	85	206/1440F3/W20
1500	1820	315	7.5	12000	42700	67	83	248/1500CA/W33
	1820	315	7.5	12000	42700	67	83	248/1500CAK30F3/W20
1600	2100	450	9.5	24500	74300	60	70	249/1600X3CA/W33
1800	2180	375	9.5	16700	59800	60	70	248/1800CA/W33
	2180	375	9.5	16700	59800	60	70	248/1800CAK30/W33
2000	2700	550	10	38000	107000	45	56	206/2000F1/C9W33X

Other dimensions				Contact surface and chamfer dimensions			Calculation coefficient				Weight
d2	D1	b	k	da	Da	ra	e	Y1	Y2	Y0	
mm				mm	mm	mm	mm				
1250	1344	22.3	12	1180	1450	5	0.14	4.80	7.20	4.50	770
1296	1432	24	12	1216	1536	6	0.16	4.20	6.30	4.00	1346
1296	1432	24	12	1216	1536	6	0.16	4.20	6.30	4.00	1391
1290	1422	22.3	12	1216	1536	6	0.20	3.42	5.09	3.34	1772
1290	1422	22.3	12	1216	1536	6	0.20	3.42	5.09	3.34	1742
1328	1509	24	12	1240	1600	8	0.20	3.42	5.09	3.34	2476
1328	1509	24	12	1240	1600	8	0.20	3.42	5.09	3.34	2460
1328	1509	24	12	1240	1600	8	0.20	3.42	5.09	3.34	2460
1296	1406	22.3	12	1236	1460	6					1150
1412	1610	22.3	12	1285	1715	8	0.19	3.60	5.30	3.60	2850
1412	1610	22.3	12	1285	1715	8	0.19	3.60	5.30	3.60	2760
1418	1513	22.3	12	1342	1578	5	0.15	4.50	6.70	4.50	1175
1418	1513	22.3	12	1342	1578	5	0.15	4.50	6.70	4.50	1150
1446	1588	24	12	1350	1691	6	0.21	3.20	4.80	3.20	2510
1446	1588	24	12	1350	1691	6	0.21	3.20	4.80	3.20	2500
1446	1588	24	12	1350	1691	6	0.21	3.20	4.80	3.20	2460
1485	1662	40	25	1390	1765	11	0.25	2.70	4.00	2.60	4540
1450	1553	22.3	12	1390	1614	6					1473
1528	1681	22.3	12	1452	1768	8	0.20	3.42	5.09	3.34	2920
1543	1652		12	1475	1723	6					1685
1608	1710	24	12	1528	1792	6	0.15	4.50	6.70	4.50	1730
1608	1710		12	1528	1792	6	0.15	4.50	6.70	4.50	1717
1755	1938	22.30	12.0								4300
1935	2058	24	12	1832	2145	8	0.15	4.50	6.70	4.50	2920
1935	2058	24	12	1832	2145	8	0.15	4.50	6.70	4.50	2870
1540	2502	52.3	25	2060	2645	8					9110

Spherical Roller Bearing(C)

d 40-75 mm

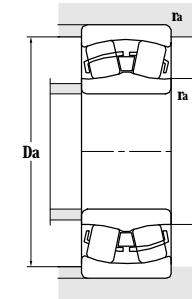
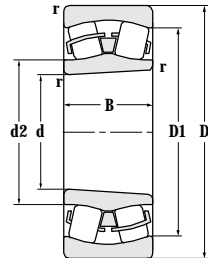
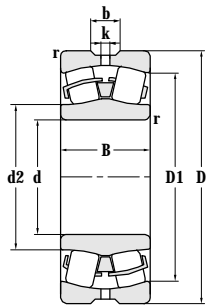

Principal dimensions				Basic load ratings		Limit speed ratings		Designations	
d	D	B	r _{min}	C _r	C _{Or}	Grease	Oil		
mm				kN		r/min			
40	80	23	1.1	91.7	85.5	6000	7500	22208C	22208C/W33
	80	23	1.1	94	87	6000	7500	22208CK	22208CK/W33
	90	33	1.5	143	133	4500	5600	22308C	22308C/W33
	90	33	1.5	143	133	4500	5600	22308CK	22308CK/W33
45	100	36	1.5	174	174	3800	4800	22309C	22309CK
	100	36	1.5	174	174	3800	4800	22309C/W33	
50	90	23	1.1	98.8	103	5000	6300	22210C	
	110	40	2	209	213	3400	4300	22310C	22310C/W33
	110	40	2	209	213	3400	4300	22310CK	22310CK/W33
55	100	25	1.5	119	121	4500	5600	22211C	22211C/W33
	100	25	1.5	119	120	4500	5600	22211CK/W33	
	120	43	2	257	266	3200	4000	22311C	22311C/W33
	120	43	2	257	266	3200	4000	22311CK	22311CK/W33
60	110	28	1.5	148	158	4300	5300	22212C	22212C/W33
	110	28	1.5	148	158	4300	5300	22212CK	22212CK/W33
	130	31	2.1	201	228	3400	4300	22312C/W33	
	130	46	2.1	295	318	2800	3600	22312C	22312C/W33
	130	46	2.1	295	318	2800	3600	22312CK	22312CK/W33
65	120	31	1.5	183	205	3800	4800	22213C	22213C/W33
	120	31	1.5	183	205	3800	4800	22213CK	22213CK/W33
	140	48	2.1	323	342	2600	3400	22313C	22313C/W33
	140	48	2.1	323	342	2600	3400	22313C/W33	
	140	48	2.1	323	342	2600	3400	22313CK	22313CK/W33
70	125	31	1.5	198	217	3600	4500	22214C	22214C/W33
	125	31	1.5	198	217	3600	4500	22214CK	22214CK/W33
	150	51	2.1	380	408	2200	3000	22314C	22314C/W33
	150	51	2.1	380	408	2200	3000	22314CK	22314CK/W33
75	130	31	1.5	201	228	3400	4300	22215C	22215C/W33
	130	31	1.5	201	228	3400	4300	22215CK	22215CK/W33

Other dimensions				Contact surface and chamfer dimensions			Calculation coefficient				Weight
d2	D1	b	k	da	Da	ra	e	Y1	Y2	Y0	
mm				mm			mm				kg
50.4	68.9	5.5	2	47	73	1	0.28	2.40	3.50	2.50	0.523
50.4	68.9	5.5	2	47	73	1	0.28	2.40	3.50	2.50	0.521
56	74	5.5	2.5	49	81	1.5	0.38	1.80	2.70	1.80	1.04
56	74	5.5	2.5	49	81	1.5	0.38	1.80	2.70	1.80	1.02
57.4	81.4			54	91	1.5	0.26	2.60	3.90	2.50	1.56
57.4	81.4			54	91	1.5	0.26	2.60	3.90	2.50	1.51
62.5	81.6			57	83	1	0.25	2.60	3.90	2.50	0.642
62.9	90.6	5.5	2.5	61	100	2	0.38	1.80	2.70	1.80	1.96
62.9	90.6	5.5	2.5	61	100	2	0.38	1.80	2.70	1.80	1.89
65.7	87.3	5.5	2	62	91	1.5	0.24	2.80	4.20	2.80	0.856
65.7	87.3	5.5	2	62	91	1.5	0.24	2.80	4.20	2.80	0.844
69	99.5	5.5	2.5	65	110	2	0.37	1.90	2.90	1.80	2.37
69	99.5	5.5	2.5	65	110	2	0.37	1.90	2.90	1.80	2.32
75.5	95	5.5	2	69	101	1.5	0.24	2.80	4.20	2.80	1.11
75.5	95	5.5	2	69	101	1.5	0.24	2.80	4.20	2.80	1.11
87.8	115	5.5	3	72	118	2	0.22	3.00	4.60	2.80	2.08
81.4	108	5.5	3	72	118	2	0.37	1.90	2.90	1.80	3.25
81.4	108	5.5	3	72	118	2	0.37	1.90	2.90	1.80	3.21
81.5	103	5.5	2.5	74	111	1.5	0.25	2.70	4.00	2.50	1.55
81.5	103	5.5	2.5	74	111	1.5	0.25	2.70	4.00	2.50	1.52
81.4	116			77	128	2	0.35	1.90	2.90	1.80	4.97
88.6	116	5.5	3	77	128	2	0.35	1.90	2.90	1.80	4.92
88.6	116	5.5	3	77	128	2	0.35	1.90	2.90	1.80	4.88
86.8	109	6	2.5	79	116	1.5	0.24	3.00	4.60	2.80	1.63
86.8	109	6	2.5	79	116	1.5	0.24	3.00	4.60	2.80	1.59
95.8	125	8.3	4	82	138	2	0.35	1.90	2.90	1.80	4.48
95.8	125	8.3	4	82	138	2	0.35	1.90	2.90	1.80	4.45
92	114	5.5	2.5	84	121	1.5	0.24	3.00	4.60	2.80	1.71
92	114	5.5	2.5	84	121	1.5	0.24	3.00	4.60	2.80	1.70

Spherical Roller Bearing(C)

d 75-100 mm

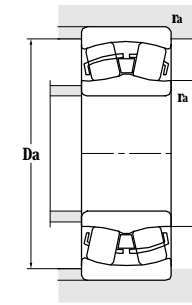
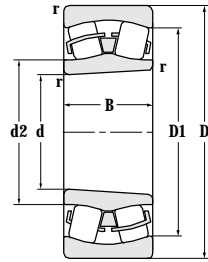
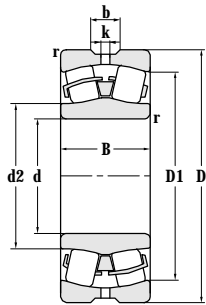

Principal dimensions				Basic load ratings		Limit speed ratings		Designations	
d	D	B	r _{min}	C _r	C _{Or}	Grease	Oil		
mm				kN		r/min			
75	160	55	2.1	418	451	2200	3000	22315C	22315C/W33
	160	55	2.1	418	451	2200	3000	22315CK	22315CK/W33
80	140	33	2	224	257	3200	4000	22216C	22216C/W33
	140	33	2	224	257	3200	4000	22216CK	22216CK/W33
	170	58	2.1	466	513	2000	2800	22316C	22316C/W33
	170	58	2.1	466	513	2000	2800	22316CK	22316CK/W33
85	150	36	2	271	309	2800	3600	22217C/W33	
	150	36	2	271	309	2800	3600	22217CK	22217CK/W33
	180	60	3	523	589	1900	2600	22317C	22317C/W33
	180	60	3	523	589	1900	2600	22317CK	22317CK/W33
90	150	72	2	320	500			24118X2C/HG2	
	160	40	2	309	356	2600	3400	22218C	22218C/W33
	160	40	2	255	356	2600	3400	22218CK	22218CK/W33
	160	52.4	2	337	480	1900	2600	23218C	
	190	64	3	580	660	1800	2400	22318C	22318C/W33
	190	64	3	580	660	1800	2400	22318CK	22318CK/W33
95	170	43	2.1	361	428	2400	3200	22219C	22219C/W33
	170	43	2.1	361	428	2400	3200	22219CK	22219CK/W33
	200	67	3	637	727	1800	2400	22319C	22319C/W33
	200	67	3	637	727	1800	2400	22319CK	22319CK/W33
100	150	37	1.5	206	325	2400	3200	23020C	23020C/W33
	150	37	1.5	206	325	2400	3200	23020CK	23020CK/W33
	165	52	2	347	515	2000	2800	23120C	23120C/W33
	165	52	2	347	515	2000	2800	23120CK	23120CK/W33
	180	46	2.1	404	466	2200	3000	22220C	22220C/W33
	180	46	2.1	404	466	2200	3000	22220CK	22220CK/W33
	180	60.3	2.1	451	600	1700	2200	23220C	23220C/W33
	180	60.3	2.1	365	605	1700	2200	23220C/HG2W33	
	215	73	3	774	903	1700	2200	22320C	22320C/W33
	215	73	3	774	903	1700	2200	22320CK	22320CK/W33

Other dimensions				Contact surface and chamfer dimensions			Calculation coefficient				Weight
d2	D1	b	k	da	Da	ra	e	Y1	Y2	Y0	
mm				mm			mm				kg
101	133	8.3	4	87	148	2	0.35	1.90	2.90	1.80	5.39
101	133	8.3	4	87	148	2	0.35	1.90	2.90	1.80	5.37
95.1	122	5.5	2.5	91	129	2	0.22	3.00	4.60	2.80	2.10
95.1	122	5.5	2.5	91	129	2	0.22	3.00	4.60	2.80	2.09
109	142	8.3	4	92	158	2	0.34	1.90	2.90	1.80	6.60
109	142	8.3	4	92	158	2	0.34	1.90	2.90	1.80	6.56
105	132	6.5	3	96	139	2	0.23	3.00	4.60	2.80	2.73
105	132	6.5	3	96	139	2	0.23	3.00	4.60	2.80	2.64
107	150	8.3	4	99	166	2.5	0.33	2.00	3.00	2.00	7.38
107	150	8.3	4	99	166	2.5	0.33	2.00	3.00	2.00	7.23
101	120			100	135	2					4.75
106	139	8.3	2.5	101	149	2	0.23	2.80	4.20	2.80	4.50
106	139	8.3	2.5	101	149	2	0.23	2.80	4.20	2.80	4.35
106	136			101	149	2	0.31	2.20	3.30	2.20	4.66
113	159	8.3	5	104	176	2.5	0.35	2.00	3.00	2.00	10.1
113	159	8.3	5	104	176	2.5	0.35	2.00	3.00	2.00	9.25
114	148	8.3	3	107	158	2	0.24	2.80	4.20	2.80	4.16
114	148	8.3	3	107	158	2	0.24	2.80	4.20	2.80	4.07
128	167	8.3	5	109	186	2.5	0.34	2.00	3.00	2.00	10.2
128	167	8.3	5	109	186	2.5	0.34	2.00	3.00	2.00	10.0
116	135	5.5	3	110	140	2	0.22	2.90	4.40	2.80	2.32
116	135	5.5	3	110	140	2	0.22	2.90	4.40	2.80	2.28
121	143	5.5	3	110	155	2	0.30	2.30	3.40	2.20	4.43
121	143	5.5	3	110	155	2	0.30	2.30	3.40	2.20	4.39
124	156	8.3	3	112	168	2	0.24	2.80	4.20	2.80	5.30
124	156	8.3	3	112	168	2	0.24	2.80	4.20	2.80	5.25
125	153	8.3	4.5	112	168	2	0.33	2.00	3.00	2.00	6.65
117	153	10	4.5	112	168	2					6.9
138	179	11.1	5	114	201	2.5	0.35	2.00	3.00	2.00	13.1
138	179	11.1	5	114	201	2.5	0.35	2.00	3.00	2.00	12.9

Spherical Roller Bearing(C)

d 105~130 mm

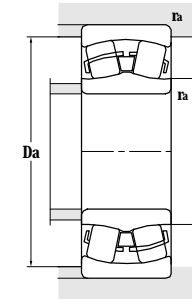
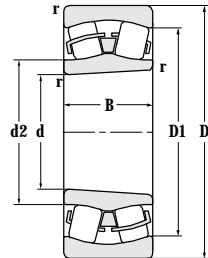
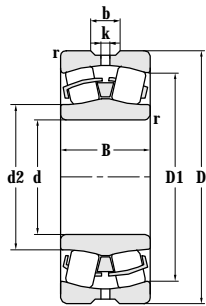

Principal dimensions				Basic load ratings		Limit speed ratings		Designations		
d	D	B	r _{min}	C _r	C _{Or}	Grease	Oil			
mm				kN		r/min				
105	175	56	2	365	560	1900	2700	23121C	23121C/W33	
	175	56	2	365	560	1900	2700	23121CK	23121CK/W33	
110	170	45	2	295	460	2200	3000	23022C	23022C/W33	
	170	45	2	295	460	2200	3000	23022C/W33-2RS2		
	170	45	2	295	460	2200	3000	23022CK	23022CK/W33	
	180	56	2	409	590	1900	2600	23122C	23122C/W33	
	180	56	2	409	590	1900	2600	23122CK	23122CK/W33	
	180	69	2	494	713	1000	1400	24122C/W24		
	200	53	2.1	530	610	2000	2800	22222C	22222C/W33	
	200	53	2.1	530	610	2000	2800	22222CK	22222CK/W33	
	200	69.8	2.1	570	830	1600	2000	23222C		
	240	80	3	761	996	1600	2000	22322C	22322C/W33	
	240	80	3	761	996	1600	2000	22322CK	22322CK/W33	
	120	180	46	2	340	495	2000	2800	23024C	
180		46	2	340	495	2000	2800	23024CK		
200		62	2	490	715	1800	2400	23124C	23124C/W33	
200		62	2	490	715	1800	2400	23124CK	23124CK/W33	
200		80	2	620	925	1400	1800	24124C		
215		58	2.1	600	730	1900	2600	22224C	22224C/W33	
215		58	2.1	600	730	1900	2600	22224CK		
215		58	2.1	600	730	1900	2600	22224C/C9		
215		58	2.1	600	730	1900	2600	22224CK	22224CK/W33	
215		76	2.1	660	940	1500	1900	23224C		
260		86	3	920	1120	1400	1800	22324C	22324C/W33	
260		86	3	920	1120	1400	1800	22324CK	22324CK/W33	
130		200	52	2	410	650	1900	2600	23026C	23026C/W33
		200	52	2	410	650	1900	2600	23026CK	23026CK/W33
	210	64	2	530	790	1700	2200	23126C	23126C/W33	
	210	64	2	530	790	1700	2200	23126CK	23126CK/W33	
	210	80	2	650	990	1700	2200	24126C/W33		
	210	80	2	650	1000	1700	2200	24126CK30/W33		
	230	64	3	700	880	1800	2400	22226C	22226C/W33	
	230	64	3	700	880	1800	2400	22226CK	22226CK/W33	

Other dimensions				Contact surface and chamfer dimensions			Calculation coefficient				Weight
d2	D1	b	k	da	Da	ra	e	Y1	Y2	Y0	
mm				mm			mm				kg
127	151	5.5	3	115	165	2	0.30	2.20	3.30	2.20	5.36
127	151	5.5	3	115	165	2	0.30	2.20	3.30	2.20	5.19
128	150	7.5	3	120	160	2	0.24	2.90	4.40	2.80	3.68
128	150	7.5	3	120	160	2	0.24	2.90	4.40	2.80	3.74
128	150	7.5	3	120	160	2	0.24	2.90	4.40	2.80	3.57
132	156	5.5	3	120	170	2	0.30	2.30	3.40	2.20	5.69
132	156	5.5	3	120	170	2	0.30	2.30	3.40	2.20	5.67
133	153		6	120	170	2	0.35	1.90	2.90	1.80	6.90
133	173	8.3	4	122	188	2	0.26	2.70	4.00	2.50	7.32
133	173	8.3	4	122	188	2	0.26	2.70	4.00	2.50	7.16
138	168			122	188	2	0.33	2.00	3.00	2.00	9.73
151	197	13.9	6	122	188	2.5	0.34	2.20	3.30	2.20	18.2
151	197	13.9	6	122	188	2.5	0.34	2.20	3.30	2.20	17.7
134	162			130	170	2	0.22	3.00	4.60	2.80	4.46
134	162			130	170	2	0.22	3.00	4.60	2.80	4.32
146	174	5.5	3	130	190	2	0.29	2.40	3.60	2.50	7.97
146	174	5.5	3	130	190	2	0.29	2.40	3.60	2.50	7.96
146	167			130	190	2	0.38	1.80	2.70	1.80	10.0
149	187	11.1	4	132	203	2	0.25	2.60	3.90	2.50	9.78
149	187	11.1	4	132	203	2	0.25	2.60	3.90	2.50	9.75
149	187	11.1	4	132	203	2	0.25	2.60	3.90	2.50	9.78
149	187	11.1	4	132	203	2	0.25	2.60	3.90	2.50	9.66
150	182			132	203	2	0.34	1.90	2.90	1.80	11.5
165	218	13.9	6	134	246	2.5	0.35	1.90	2.90	1.80	23.8
165	218	13.9	6	134	246	2.5	0.35	1.90	2.90	1.80	21.9
153	179	9.5	4	140	190	2	0.24	2.90	4.40	2.80	6.12
153	179	9.5	4	140	190	2	0.24	2.90	4.40	2.80	5.94
156	183	8.3	4	140	200	2	0.28	2.40	3.50	2.50	9.66
156	183	8.3	4	140	200	2	0.28	2.40	3.50	2.50	9.21
146	178	8.3	4	140	200	2					10.9
146	178	8.3	4	140	200	2					10.9
162	200	10	5	144	216	2.5	0.26	2.50	3.70	2.50	11.5
162	200	10	5	144	216	2.5	0.26	2.50	3.70	2.50	11.3

Spherical Roller Bearing(C)

d 30-60 mm

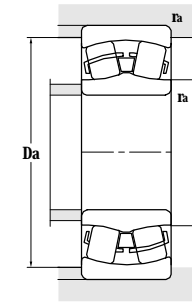
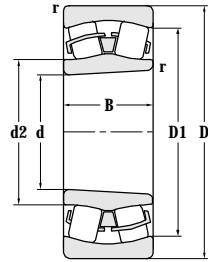
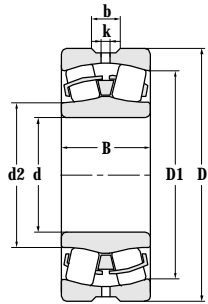

Principal dimensions				Basic load ratings		Limit speed ratings		Designations	
d	D	B	r _{min}	C _r	C _{Or}	Grease	Oil		
mm				kN		r/min			
130	280	93	4	1060	1320	1300	1700	22326C	22326C/W33
	280	93	4	1060	1320	1300	1700	22326CK	22326CK/W33
140	210	53	2	440	715	1800	2400	23028C	23028C/W33
	210	53	2	440	715	1800	2400	23028CK	23028CK/W33
	225	68	2.1	600	935	1600	2000	23128C	23128C/W33
	225	68	2.1	600	935	1600	2000	23128CK	23128CK/W33
	250	68	3	670	860	1700	2200	22228C	22228C/W33
	250	68	3	670	860	1700	2200	22228CK	22228CK/W33
	250	88	3	810	1300	1200	1600	23228C/W33	
	300	102	3.7	1230	1590	1100	1500	22328C	22328C/W33
	300	102	3.7	1230	1590	1100	1500	22328CK	22328CK/W33
150	225	56	2.1	485	730	1700	2200	23030C	23030C/W33
	225	56	2.1	485	730	1700	2200	23030CK	23030CK/W33
	250	80	2.1	790	1230	1400	1800	23130C	23130C/W33
	250	80	2.1	790	1230	1400	1800	23130CK	23130CK/W33
	250	100	2.1	970	1450	800	1000	24130C	
	270	73	3	810	1100	1600	2000	22230C	22230C/W33
	270	96	3	1030	1390	1100	1500	23230C	
	320	108	4	1320	1820	1000	1400	22330C	
160	240	60	2.1	555	875	1700	2200	23032C	23032C/W33
	240	60	2.1	555	875	1700	2200	23032CK	23032CK/W33
	270	86	2.1	930	1420	1300	1700	23132C	23132C/W33
	270	86	2.1	930	1420	1300	1700	23132CK	23132CK/W33
	270	109	2.1	1120	1690	700	900	24132C/W33	
	290	80	3	950	1280	1500	1900	22232C	22232C/W33
	290	80	3	950	1280	1500	1900	22232CK	22232CK/W33
	290	104	3	1160	1760	1000	1400	23232C	23232C/W33
	290	104	3	1160	1760	1000	1400	23232CK/W33	
	340	114	4	1520	2050	950	1300	22332C	22332C/W33
	340	114	4	1520	2050	950	1300	22332CK	22332CK/W33
170	260	67	2.1	670	1150	1600	2000	23034C	23034C/W33
	260	67	2.1	670	1150	1600	2000	23034CK	23034CK/W33

Other dimensions				Contact surface and chamfer dimensions			Calculation coefficient				Weight
d2	D1	b	k	da	Da	ra	e	Y1	Y2	Y0	
mm				mm			mm				kg
178	232	16.7	6	148	262	3	0.34	1.90	2.90	1.80	24.9
178	232	16.7	6	148	262	3	0.34	1.90	2.90	1.80	24.3
162	188	8.3	4.5	150	200	2	0.22	3.00	4.60	2.80	6.37
162	188	8.3	4.5	150	200	2	0.22	3.00	4.60	2.80	6.17
166	196	8.3	5	152	213	2	0.28	2.40	3.60	2.50	10.8
166	196	8.3	5	152	213	2	0.28	2.40	3.60	2.50	10.5
176	218	11.1	5	154	236	2.5	0.26	2.60	3.90	2.50	14.5
176	218	11.1	5	154	236	2.5	0.26	2.60	3.90	2.50	14.5
164	212	11.1	6	154	236	2.5					18.1
191	249	16.7	7	158	282	3	0.34	1.90	2.90	1.80	35.2
191	249	16.7	7	158	282	3	0.34	1.90	2.90	1.80	34.8
174	201	8.3	4.5	162	213	2	0.22	3.00	4.60	2.80	7.44
174	201	8.3	4.5	162	213	2	0.22	3.00	4.60	2.80	7.42
173	216	11.1	5	162	238	2	0.30	2.30	3.40	2.20	16.3
173	216	11.1	5	162	238	2	0.30	2.30	3.40	2.20	15.8
180	208			162	238	2	0.37	1.80	2.70	1.80	18.7
179	234	12	6	164	256	2.5	0.26	2.60	3.90	2.50	18.6
177	228			164	256	2.5	0.35	1.90	2.90	1.80	25.7
188	270			168	302	3					42.5
180	216	11.1	4	172	228	2	0.22	3.00	4.60	2.80	8.99
180	216	11.1	4	172	228	2	0.22	3.00	4.60	2.80	8.76
188	234	13.9	6	172	258	2	0.30	2.30	3.40	2.20	22
188	234	13.9	6	172	258	2	0.30	2.30	3.40	2.20	21.4
193	225	8.3	4	172	258	2	0.40	1.69	2.51	1.65	24.8
201	249	13.9	5	174	276	2.5	0.27	2.50	3.70	2.50	23.2
201	249	13.9	5	174	276	2.5	0.27	2.50	3.70	2.50	22.7
201	244	13.9	7	174	276	2.5	0.35	1.90	2.90	1.80	29.7
200	244	13.9	7	174	276	2.5	0.35	1.90	2.90	1.80	29.0
189	284	16.7	7	178	322	3	0.35	1.90	2.90	1.80	51.6
216	284	16.7	7	178	322	3	0.35	1.90	2.90	1.80	50.9
192	231	11.1	5	182	248	2	0.23	2.90	4.40	2.80	14.3
192	231	11.1	5	182	248	2	0.23	2.90	4.40	2.80	13.8

Spherical Roller Bearing(C)

d 30-60 mm

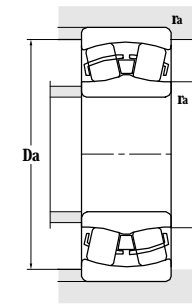
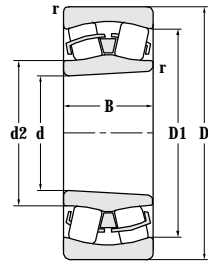
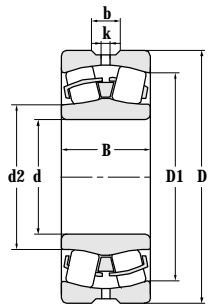

Principal dimensions				Basic load ratings		Limit speed ratings		Designations
d	D	B	r _{min}	C _r	C _{0r}	Grease	Oil	
mm				kN		r/min		
170	280	88	2.1	990	1520	1200	1600	23134C
	280	88	2.1	990	1520	1200	1600	23134CK
	310	86	4	1060	1450	1300	1700	22234C
	310	86	4	1060	1450	1300	1700	22234CK
	360	120	4	1670	2050	950	1300	22334C
180	280	74	2.1	790	1290	1400	1800	23036C
	280	74	2.1	790	1290	1400	1800	23036CK
	300	96	3	1140	1720	1100	1500	23136C/W33
	320	86	4	1120	1550	1300	1700	22236C
	320	86	4	1120	1550	1300	1700	22236CK
	380	126	4	1900	2400	900	1200	22336C
	380	126	4	1900	2400	900	1200	22336CK
190	290	75	2.1	820	1270	1300	1700	23038C
	320	128	3	1370	2330	600	750	24138CK30/W33
	340	92	4	1210	1700	1200	1600	22238C
	340	92	4	1210	1700	1200	1600	22238CK
	400	132	5	2010	2520	850	1100	22338C
	400	132	5	2010	2780	850	1100	22338C
	400	132	5	2010	2780	850	1100	22338CK
200	310	82	2.1	950	1560	1200	1600	23040C
	310	82	2.1	950	1560	1200	1600	23040CK
	340	112	3	1370	2330	950	1300	23140C/W33
	360	98	4	1390	1950	1100	1500	22240C
	420	138	5	2000	2870	850	1100	22340C
	420	138	5	2000	2870	850	1100	22340CK
220	340	90	3	1058	1987	1100	1500	23044C/W33-ZH
240	360	92	3	1130	2080	1000	1400	23048C/W33
	360	118	3	1420	2790	800	1000	24048C/W33
	400	128	4	1980	3040	850	1100	23148C
	400	128	4	1980	3040	850	1100	23148CK
	440	160	4	2400	3950	670	850	23248CK30/W33

Other dimensions				Contact surface and chamfer dimensions			Calculation coefficient				Weight
d2	D1	b	k	da	Da	ra	e	Y1	Y2	Y0	
mm				mm			mm				kg
204	243			182	268	2	0.30	2.30	3.40	2.20	22
204	243	8.3	5	182	268	2	0.30	2.30	3.40	2.20	21.3
215	268	16.7	6	188	292	3	0.27	2.50	3.70	2.50	29.3
215	268	16.7	6	188	292	3	0.27	2.50	3.70	2.50	28.6
211	299			188	342	3	0.37	1.80	2.70	1.80	59.7
214	247	13.9	7.5	192	268	2	0.25	2.70	4.00	2.60	17.3
214	247	13.9	7.5	192	268	2	0.25	2.70	4.00	2.60	17.1
216	259	13.9	6	194	286	2.5	0.30	2.30	3.40	2.20	26.3
224	278	16.7	6	198	302	3	0.26	2.60	3.90	2.50	30.1
224	278	16.7	6	198	302	3	0.26	2.60	3.90	2.50	29.4
242	316	22.3	8	198	362	3	0.34	1.99	2.96	1.94	70.1
242	316	22.3	8	198	362	3	0.34	1.99	2.96	1.94	68.8
215	259			202	278	2	0.23	2.90	4.40	2.80	16.9
211	267	11.1	6	204	306	2.5	0.23	2.90	4.40	2.80	40.7
235	293	16.7	6	208	322	3	0.26	2.60	3.90	2.50	36.7
235	293	16.7	6	208	322	3	0.26	2.60	3.90	2.50	35.9
238	334			212	378	4	0.34	1.99	2.96	1.94	80.8
257	334	22.3	8	212	378	4	0.34	1.99	2.96	1.94	82.4
257	334	22.3	8	212	378	4	0.34	1.99	2.96	1.94	81.4
237	276	13.9	7.5	212	298	2	0.25	2.70	4.00	2.60	24.8
237	276	13.9	7.5	212	298	2	0.25	2.70	4.00	2.60	24.6
230	292	16.7	9	214	326	2.5					42.3
237	309			218	342	3	0.26	2.60	3.90	2.50	43.7
269	350	22.3	8	222	398	4	0.34	1.99	2.96	1.94	92.3
269	350	22.3	8	222	398	4	0.34	1.99	2.96	1.94	90.3
252	305	13.9	7.5	240	320	2.5					29.8
271	326	13.9	7.5	260	335	2.5					33.1
264	316	11.1	6	254	346	2.5					42.3
289	345	16.7	8	258	382	3	0.31	2.21	3.29	2.16	65.9
289	345	16.7	8	258	382	3	0.31	2.21	3.29	2.16	63.9
282	369	22.3	12	258	422	3					107

Spherical Roller Bearing(C)

d 30-60 mm

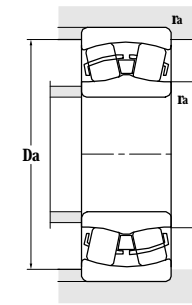
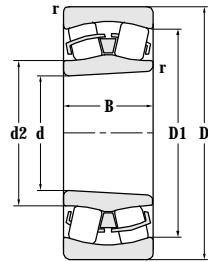
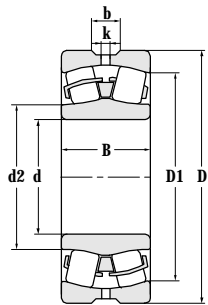

Principal dimensions				Basic load ratings		Limit speed ratings		Designations
d	D	B	r _{min}	C _r	C _{0r}	Grease	Oil	
mm				kN		r/min		
240	440	160	4	2400	3950	670	850	23248CK/W33
260	400	104	4	1520	2560	900	1200	23052C
	400	104	4	1520	2560	900	1200	23052CK
	440	144	4	2250	4020	800	1000	23152C/W33
	480	130	5	2520	3600	850	1100	22252C/W33-ZH
	540	165	6	3370	4650	630	800	22352C/C9W33
280	420	106	4	1640	2940	850	1100	23056C
	420	106	4	1640	2940	850	1100	23056CK
	460	146	5	2230	4060	750	950	23156C/W33
300	460	118	4	1840	3440	600	750	23060C/W33-ZH
	460	160	4	2570	4780	600	750	24060C/W33
	500	200	5	3560	5990	600	750	SX-24160C
320	480	160	4	2700	5200	560	700	24064C/W33
	580	208	5	3950	7010	500	630	23264CK/W33
340	520	133	5	2340	4430	530	670	23068C/W33-ZH
	520	180	5	3280	5890	530	670	24068C/W33
	520	180	5	3280	5890	530	670	24068CK30/W33
	521	181	5	3280	6170	530	670	24068CK30/W33
360	540	134	5	2610	4680	670	850	23072C/W33
380	560	180	5	3420	7000	480	600	24076C/W33

Other dimensions				Contact surface and chamfer dimensions			Calculation coefficient				Weight	
d2	D1	b	k	da	Da	ra	e	Y1	Y2	Y0		
mm				mm			mm					
282	369	22.3	12	258	422	3					107	
306	357	16.7	7	278	382	3	0.23	2.90	4.40	2.80	48	
	357	16.7	7	278	382	3	0.23	2.90	4.40	2.80	47.7	
	300	379	16.7	9	278	422	3				90.2	
	330	410	22.3	12	282	458	4				110	
	349	455	22.3	8	288	512	5	0.31	2.20	3.30	2.20	185
323	377	16.7	7	298	402	3	0.23	2.91	4.40	2.84	55.1	
	323	377	16.7	7	298	402	3	0.23	2.91	4.40	54	
	320	400	16.7	9	302	438	4				97.2	
338	412	16.7	9	323	437	3					71.8	
	342	399	13.9	7	318	442	3	0.32	2.09	3.11	2.04	97.3
	356	420	13.9	6	322	478	4	0.39	1.75	2.61	1.71	161
354	423	22	8	335	465	3	0.32	2.09	3.11	2.04	97.9	
	379	488	22.3	12	342	558	4				241	
383	467	22.3	12	316	495	4					102	
	377	453	16.7	9	358	502	4	0.33	2.00	3.00	2.00	139
	377	453	16.7	9	358	502	4	0.33	2.00	3.00	2.00	137
	377	453	16.7	9	358	502	4	0.33	2.00	3.00	2.00	137
419	486	22.3	8	382	518	4	0.23	2.90	4.40	2.80	108	
435	494	16.7	9	402	538	4	0.3	2.3	3.4	2.2	152	

Spherical Roller Bearing(CC)

d 45-110 mm

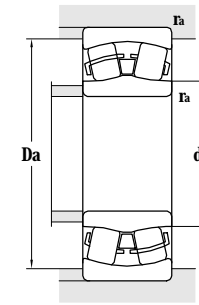
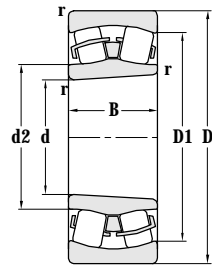
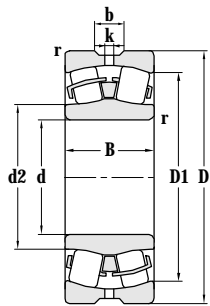

Principal dimensions				Basic load ratings		Limit speed ratings		Designations
d	D	B	r _{min}	C _r	C _{Or}	Grease	Oil	
mm				kN		r/min		
45	100	36	1.5	130	155	3700	4700	22309CC
50	90	23	1.1	80	95	4800	6100	22210CC
55	100	25	1.5	95	115	4400	5500	22211CC
60	110	28	1.5	115	140	3900	4900	22212CC
	130	46	2.05	255	2.1	2900	3700	22312CC
65	120	31	1.5	170	216	2800	3600	22213S/W33
	140	48	2.1	235	275	2500	3300	22313CC
70	125	31	1.5	135	175	3500	4400	22214CC
	150	51	2.1	285	355	2300	3100	22314CC/W33
75	130	1.5	31	145	190	3300	4200	22215CC
	160	55	2.1	310	405	2100	2900	22315CC/W33
80	140	33	2	160	210	3100	3900	22216CC
	170	58	2.1	325	410	1900	2700	22316CC/W33
85	150	36	2	246	325	3000	3800	22217CC/W33
	180	60	3	395	495	1800	2500	22317CC/W33
90	160	52.4	2	345	440	2700	3600	23218CC/W33
	190	64	3	477	610	1800	2400	22318CC
95	170	43	2.1	265	355	2300	3100	22219CC/W33
	200	67	3	485	645	1700	2300	22319CC/W33
100	165	52	2	300	450	1900	2700	23120CC/W33
	180	46	2.1	290	390	2100	2900	22220CC/W33
	180	60.3	2.1	460	610	2300	3300	23220CC/W33
	215	73	3	774	903	1700	2200	22320CC/W33
110	170	45	2	300	460	3000	4100	23022CC/W33

22318CC/W33

Other dimensions				Contact surface and chamfer dimensions			Calculation coefficient				Weight
d2	D1	b	k	da	Da	ra	e	Y1	Y2	Y0	
mm				mm	mm	mm	mm				
57.6	82.5	-	-	54	91	1.5	0.37	1.80	2.70	1.80	1.35
60	79.2			57	83	1	0.24	2.80	4.20	2.80	0.6
66	88.1			64	91	1.5	0.24	2.80	4.20	2.80	0.82
72.7	96.6			69	101	1.5	0.24	2.8	4.20	2.80	1.1
				72	118	2	0.35	1.9	2.90	1.80	2.95
77	106	5.5	3	74	111	1.5	0.24	2.80	4.20	2.80	1.57
				82	128	2	0.35	1.90	2.90	1.80	3.55
84.6	111	8.3	4.5	79	116	1.5	0.23	2.90	4.40	2.80	1.55
				82	138	2	0.35	1.90	2.90	1.80	4.3
89.7	116	8.3	4.5	84	121	1.5	0.22	3.00	4.60	2.80	1.65
				87	148	2	0.35	1.90	2.90	1.80	5.25
95.1	124	8.3	4.5	90	130	2	0.22	3.00	4.60	2.80	2.05
				92	158	2	0.35	1.90	2.90	1.80	6.2
101	133	5.5	3	96	139	2	0.22	3.00	4.60	2.80	2.68
106	154	8.3	4.5	99	166	2.5	0.33	2.00	3.00	2.00	7.25
106	137	5.5	3	101	149	2	0.31	2.20	3.30	2.20	4.54
159	159	11.1	6	104	176	2.5	0.35	1.90	2.90	1.80	8.72
113	149	8.3	4.5	107	158	2	0.24	2.80	4.20	2.80	4
				109	186	2.5	0.35	1.90	2.90	1.80	10
115	145	5.5	3	110	155	2	0.3	2.30	3.40	2.20	4.4
120	157	8.3	4.5	112	168	2	0.24	2.80	4.20	2.80	4.85
117	153	8.3	4.5	112	168	2	0.33	2.00	3.00	2.00	6.47
138	179	11.1	5	114	201	2.5	0.35	1.90	2.90	1.80	13.4
126	151	5.5	3	120	160	2	0.23	2.90	4.40	2.80	3.69

Spherical Roller Bearing(CC)

d 110~170 mm

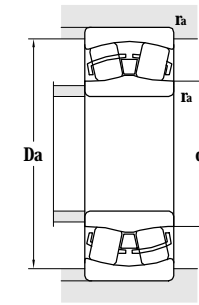
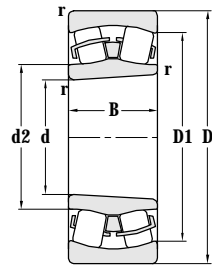
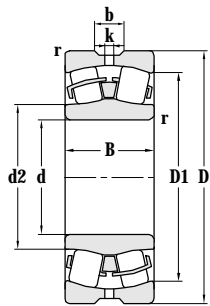

Principal dimensions				Basic load ratings		Limit speed ratings		Designations
d	D	B	r _{min}	C _r	C _{0r}	Grease	Oil	
mm				kN		r/min		
110	180	56	2	355	565	1800	2500	23122CC/W33
	200	53	2.1	370	520	1900	2700	22222CC/W33
	240	80	3	770	1020	1600	2000	22322CC/W33
120	180	46	2	345	510	3000	3900	23024CC/W33
	180	60	2	420	670	2300	3300	24024CC/W33
	200	62	2	400	645	1700	2300	23124CC/W33
	200	80	2	545	910	850	1100	24124CC/W33
	215	58	2.1	510	730	1900	2600	22224CC/W33
	215	76	2.1	560	880	1400	1800	23224CC/W33
	260	86	3	840	1100	1300	1700	22324CC/W33
130	210	64	2	450	710	1600	2100	23126CC/W33
	230	64	3	500	750	1700	2300	22226CC/W33
	230	80	3	630	1000	1200	1600	23226CC/W33
	280	93	4	1090	1310	1750	2300	22326CC/W33
140	225	68	2.1	495	850	1500	1900	23128CC/W33
	250	68	3	600	900	1700	2200	22228CC/W33
	300	102	4	1100	1500	1000	1400	22328CC/W33
150	225	56	2.1	400	700	1600	2100	23030CC/W33
	225	75	2.1	635	1080	1750	2500	24030CC/W33
	250	80	2.1	675	1140	1300	1700	23130CC/W33
	270	73	3	700	1000	1500	1900	22230CC/W33
	270	73	3	810	1100	1600	2000	22230CS/W33
	320	108	4	1200	1710	900	1300	22330CC/W33
160	240	60	2.1	470	810	1600	2100	23032CC/W33
	270	86	2.1	790	1300	1200	1600	23132CC/W33
	270	109	2.1	1000	1700	650	850	24132CC/W33
	290	80	3	845	1250	1400	1800	22232CC/W33
	340	114	4	1350	1940	900	1200	22332CC/W33
170	260	67	2.1	600	1040	1500	1900	23034CC/W33

Other dimensions				Contact surface and chamfer dimensions			Calculation coefficient				Weight kg
d2	D1	b	k	da	Da	ra	e	Y1	Y2	Y0	
mm				mm	mm	mm	mm				
126	157	8.3	4.5	120	170	2	0.30	2.30	3.40	2.20	5.55
132	173	8.3	4.5	122	188	2	0.25	2.70	4.00	2.50	7
141	197	13.9	7.5	122	188	2.5	0.35	1.90	2.90	1.80	17.8
134	163	5.5	3	130	170	2	0.22	3.00	4.60	2.80	4.08
132	158	5.5	4	130	170	2	0.30	2.30	3.40	2.20	5.53
139	173	8.3	4.5	130	190	2	0.28	2.40	3.60	2.50	7.8
135	169	5.5	3	130	190	2	0.37	1.80	2.70	1.80	10
143	187	11.1	6	132	203	2	0.25	2.70	4.00	2.50	9.06
141	183	8.3	4.5	132	203	2	0.35	1.90	2.90	1.80	22
152	216	13.9	7.5	134	246	2.5	0.35	1.90	2.90	1.80	22
148	184	8.3	4.5	140	200	2	0.28	2.40	3.60	2.50	8.55
153	200	11.1	6	144	216	2.5	0.26	2.60	3.90	2.50	11
152	196	8.3	4.5	144	216	2.5	0.33	2.00	3.00	2.00	14
157	233	16.7	9	148	262	3	0.35	1.90	2.90	1.80	28.1
159	196	8.3	4.5	152	213	2	0.28	2.40	3.60	2.50	13
166	216	11.1	6	154	236	2.5	0.26	2.60	3.90	2.50	14
175	247	16.7	9	158	282	3	0.35	1.90	2.90	1.80	34.5
169	203	8.3	4.5	162	213	2	0.22	3.00	4.60	2.80	7.95
164	196	5.5	3	162	213	2	0.30	2.30	3.40	2.20	10.3
173	216	11.1	6	162	238	2	0.30	2.30	3.40	2.20	16
179	234	13.9	7.5	164	256	2.5	0.26	2.60	3.90	2.50	18
179	234	13.9	7.5	164	256	2.5	0.25	2.60	3.90	2.50	18.4
189	267	16.7	9	168	302	3	0.35	1.90	2.90	1.80	41.5
181	217	11.1	6	172	228	2	0.22	3.00	4.60	2.80	9.7
185	234	13.9	7.5	172	258	2	0.30	2.30	3.40	2.20	20.5
181	228	8.3	4.5	172	258	2	0.4	1.70	2.50	1.60	25
191	250	13.9	7.5	174	276	2.5	0.26	2.60	3.90	2.50	22.5
201	282	16.7	9	178	322	3	0.35	1.90	2.90	1.80	50
192	232	11.1	6	182	248	2	0.23	2.90	4.40	2.80	13

Spherical Roller Bearing(CC)

d 170~300 mm

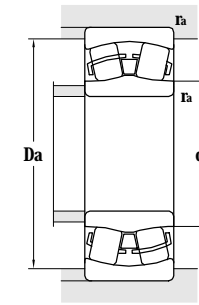
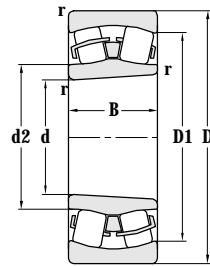
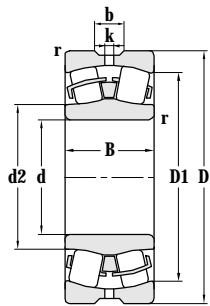

Principal dimensions				Basic load ratings		Limit speed ratings		Designations
d	D	B	r _{min}	C _r	C _{Or}	Grease	Oil	
mm				kN		r/min		
170	280	88	2.1	800	1400	1100	1500	23134CC/W33
310	86	4	900	1410	1200	1600	22234CC/W33	
360	120	4	1490	2100	900	1200	22334CC/W33	
180	280	74	2.1	700	1220	1300	1700	23036CC/W33
300	96	3	1160	1760	1600	2100	23136CC/W33	
320	86	4	980	1500	1200	1600	22236CC/W33	
380	126	4	1680	2390	850	1100	22336CC/W33	
190	290	75	2.1	700	1280	1200	1600	23038CC/W33
340	92	4	1100	1650	1200	1500	22238CC/W33	
340	120	4	1390	2300	800	1500	23238CC/W33	
400	132	5	1800	2580	800	1000	22338CC/W33	
200	360	98	4	1200	1880	1000	1400	22240CC/W33
420	138	5	1960	2800	800	1000	22340CC/W33	
220	370	150	4	1800	3300	450	600	24144CC/W33
400	144	4	2000	3350	700	900	23244CC/W33	
240	360	92	3	1100	2000	1000	1400	23048CC/W33
360	118	3	1300	2650	700	900	24048CC/W33	
400	128	4	1700	3100	790	1000	23148CC/W33	
400	160	4	2000	3800	450	650	24148CC/W33	
260	440	144	4	2470	3900	1000	1400	23152CC/W33
280	420	140	4	1800	3700	600	800	24056CC/W33
300	420	90	3	1150	2440	900	1200	23960CC/W33

Other dimensions				Contact surface and chamfer dimensions			Calculation coefficient				Weight
d2	D1	b	k	da	Da	ra	e	Y1	Y2	Y0	
mm				mm			mm				
195	244	13.9	7.5	182	268	2	0.30	2.30	3.40	2.20	21.5
204	267	16.7	9	188	292	3	0.27	2.50	3.70	2.50	28.5
213	300	16.7	9	188	342	3	0.33	2.00	3.00	2.00	58.5
204	248	13.9	7.5	192	268	2	0.24	2.80	4.20	2.80	17
207	259	13.9	7.5	194	286	2.5	0.30	2.30	3.40	2.20	27
214	277	16.7	9	198	302	3	0.26	2.60	3.90	2.50	29.5
224	317	22.3	12	198	362	3	0.35	1.90	2.90	1.80	69
216	260	13.9	7.5	202	278	2	0.23	2.90	4.40	2.80	18
226	294	16.7	9	208	322	3	0.19	3.60	5.30	3.60	36.5
223	287	16.7	9	208	322	3	0.35	1.90	2.90	1.80	47.5
237	333	22.3	12	212	378	4	0.35	1.90	2.90	1.80	80
238	312	16.7	9	218	342	3	0.26	2.60	3.90	2.50	43.5
249	351	22.3	12	222	398	4	0.33	2.00	3.00	2.00	92.5
248	310	11.1	6	238	352	3	0.4	1.70	2.50	1.60	65
260	338	16.7	9	238	382	3	0.35	1.90	2.90	1.80	79.5
271	325	13.9	7.5	254	346	2.5	0.23	2.90	4.40	2.80	33.5
265	316	11.1	6	254	346	2.5	0.3	2.30	3.40	2.20	42.5
277	347	16.7	9	258	382	3	0.3	2.30	3.40	2.20	65.5
271	337	11.1	6	258	382	3	0.4	1.70	2.50	1.60	80.5
300	379	16.7	9	278	422	3	0.31	2.20	3.30	2.20	90.2
309	368	11.1	6	298	402	3	0.31	2.20	3.30	2.20	68.5
333	385	11.1	6	314	406	2.5	0.19	3.60	5.30	3.60	40.5

Spherical Roller Bearing(Split D)

d 120~800 mm

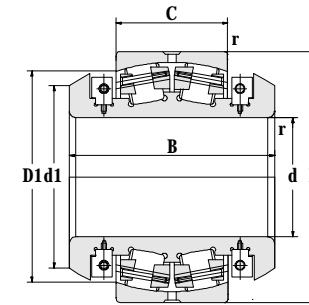
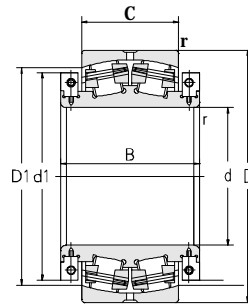

Principal dimensions					Basic load ratings	
d	D	B	C	r _{min}	C _r	Cor
mm					kN	
120	200	80	80	2	540	870
140	230	53	53	2	350	580
180	300	74	74	2.1	680	1050
280	500	176	176	5	2650	4400
300	500	160	160	5	1660	4800
360	540	134	134	5	2150	4480
400	600	148	148	5	2750	5800
420	620	150	150	6	2750	5850
460	700	165	165	6	3150	6500
530	780	185	185	6	3400	8100
560	870	200	200	6	5020	10500
600	980	375	375	7.5	10000	21500
630	920	212	212	7.5	5650	12500
670	980	230	230	7.5	6400	13500
710	950	243	243	6	5720	15100
	1030	236	236	7.5	6900	15500
750	1000	250	250	6	6310	16800
	1090	250	250	7.5	6810	15230
800	1060	258	258	6	6850	18500
	1150	258	258	7.5	6850	15600

Designations	Other dimensions		Calculation coefficient				Weight
	d1	D1	e	Y1	Y2	Y0	
	mm		mm				kg
24124D	165	168	0.37	1.8	2.7	1.8	18.5
23028D	181	190	0.22	3	4.6	2.8	15.2
23136X2D	221	247	0.24	2.8	4.2	2.8	32
23256D	420	438	0.35	1.9	2.9	1.9	178
23160D	419	434	0.3	2.3	3.4	2.2	135
23072D	477	481	0.23	2.9	4.4	2.8	158
23080D	523	540	0.23	2.9	4.4	2.8	210
23084D	542	561	0.22	3	4.6	2.8	160
23092X3D	605	635	0.21	3.2	4.8	3.2	346
230/530D	666	704	0.21	3.2	4.8	3.2	389
230/560X3D	734	785	0.22	3	4.6	2.8	585
241/600D	812	833	0.35	1.9	2.9	1.8	1370
230/630D	799	836	0.21	3.2	4.8	3.2	636
230/670D	862	890	0.21	3.2	4.8	3.2	820
249/710D	862	867	0.22	3	4.6	2.8	710
230/710D	902	938	0.21	3.2	4.8	3.2	895
249/750D	901	915	0.22	3	4.6	2.8	716
230/750D	931	992	0.2	3.4	5	3.2	961
249/800D	957	967	0.21	3.2	4.8	3.2	815
230/800D	885	1045	0.27	2.50	3.70	2.50	1087

Spherical Roller Bearing(Split D)

d 800~1250 mm

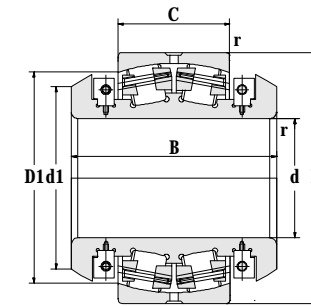
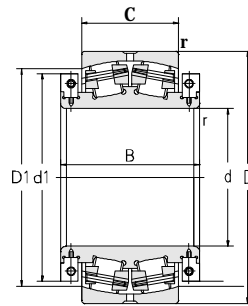

Principal dimensions					Basic load ratings	
d	D	B	C	r _{min}	C _r	C _{or}
mm					kN	
800	1150	540	258	7.5	6850	15600
	1150	490	325	7.5	12200	30500
850	1120	390	272	6	7350	20500
	1220	455	365	7.5	10900	25800
	1220	660	365	7.5	10900	25800
	1220	540	365	7.5	10900	25800
	1280	540	375	7.5	12200	30600
884	1320	478	365	9.5	11000	24900
900	1180	400	280	6	8100	22600
	1270	478	365	9.5	9800	24600
	1270	470	365	9.5	9800	24600
	1270	470	365	9.5	9850	24600
	1280	498	375	9.5	9800	24600
	1320	478	365	9.5	9800	24100
950	1250	420	300	7.5	8800	25200
	1360	420	300	7.5	9100	21000
	1360	640	300	7.5	9100	21000
1000	1470	530	345	9.5	14400	35900
	1420	556	412	7.5	13300	34500
1060	1460	500	335	7.5	11400	33000
	1500	585	438	9.5	15000	40000
	1500	611.5	438	9.5	15000	40000
	1500	575	438	9.5	15000	40000
1120	1460	500	335	7.5	11300	33000
	1540	525	355	7.5	14200	43000
1180	1540	500	355	7.5	10000	31500
1250	1750	560	375	9.5	19500	48000

Designations	Other dimensions		Calculation coefficient				Weight
	d1	D1	e	Y1	Y2	Y0	
	mm		mm				kg
230/800DW	885	1045					1367
240/800X2D	1045	1075	0.27	2.5	3.7	2.5	1990
249/850D	1010	1027	0.22	3	4.6	2.8	835
240/850D	1030	1092	0.27	2.5	3.7	2.5	1650
240/850WD	1030	1092	0.27	2.5	3.7	2.5	1931
240/850WBD	1060	1092	0.27	2.5	3.7	2.5	1781
240/850X3D	1124	1146	0.26	2.6	3.9	2.5	2380
240/884D/HC			0.25	2.7	4	2.6	2457
239/900X2	1059	1085	0.21	3.2	4.8	3.2	1120
240/900X3D	1118	1130	0.25	2.7	4	2.6	1970
240/900X3D-2	1118	1130	0.25	2.7	4	2.6	1970
240/900X3D-3	1118	1130	0.25	2.7	4	2.6	1880
240/900X2D/HC	1118	1130	0.25	2.7	4	2.6	2064
240/900X3D/HCC9-2	1140	1178	0.24	2.8	4.2	2.8	2050
249/950D	1132	1148	0.21	3.2	4.8	3.2	1320
230/950D	1169	1234	0.2	3.4	5	3.2	1956
230/950D-1	1050	1234	0.2	3.4	5	3.2	2338
230/100X3D	1271	1338	0.21	3.2	4.8	3.2	3030
240/1000D	1107	1276					2633
249/1060X1D	1331	1349	0.2	3.4	5	3.2	2476
240/1060D	1164	1349	0.2	3.4	5	3.2	3083
240/1060D-1	1164	1349	0.2	3.4	5	3.2	3089
240/1060D-2	1164	1349	0.2	3.4	5	3.2	3354
249/1120D	1331	1349	0.2	3.4	5	3.2	2100
240/1120X3D	1403	1419	0.2	3.4	5	3.2	2920
249/1180D	1394	1428	0.2	3.4	5	3.2	2254
230/1250D	1562	1607	0.19	3.6	5.3	3.6	3850

Spherical Roller Bearing(Vibration Screen VB)

d 80-170 mm

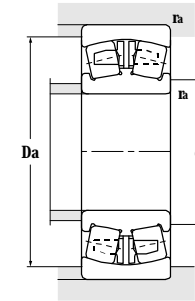
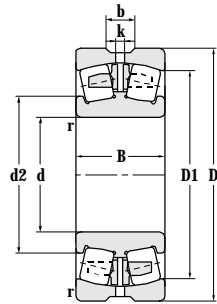

Principal dimensions				Basic load ratings		Limit speed ratings		Designations
d	D	B	r _{min}	C _r	C _{Or}	Grease	Oil	
mm				kN		r/min		
80	170	58	2.1	345	495	2000	2800	22316/VBW33
85	180	60	3	355	505	1900	2600	22317Q1/VB
	180	60	3	355	505	1900	2600	22317Q1/VBW33
90	190	64	3	462	625	1800	2400	22318/VBW33
95	200	67	3	485	685	1800	2400	22319/VBW33
100	215	73	3	530	650	1800	2400	22320Q1/VB
	215	73	3	530	650	1800	2400	22320Q1/VBW33
105	175	56	2	402	550	1900	2700	22321Q1/VB
110	240	80	3	650	910	1600	2000	22322Q1/VB
	240	80	3	650	910	1600	2000	22322Q1/VBW33
120	260	86	3	840	1100	1400	1800	22324Q1/VB
	260	86	3	840	1100	1400	1800	22324Q1/VBW33
130	230	64	3	495	685	1800	2400	22226KQ1/VBW33
	280	93	4	840	1300	1300	1700	22326/VBHAC9W33
	280	93	4	840	1300	1300	1700	22326/VBW33
140	300	102	4	840	1300	1200	1600	22328Q1/VBW33
	300	118	4	1060	1450	1100	1500	23328Q1/VBW33
150	320	108	4	1160	1580	1100	1500	22330Q1/VBW33
160	290	80	3	950	1230	1500	1900	22232KQ1/VBW33
	340	114	4	1400	2050	950	1300	22332Q1/VBW33
	340	136	4	1520	1860	950	1300	23332Q1/VBW33
170	360	120	4	1500	2110	1300	1700	22334Q1/VBW33
	360	136	4	1880	2540	800	1000	23334X2Q1/VBHAC9W33

Other dimensions				Contact surface and chamfer dimensions			Calculation coefficient			Weight	
d1	D1	b	k	da	Da	ra	e	y1	y2		y0
mm				mm			mm			kg	
109	142			92	158	2	0.34	1.99	2.96	1.94	6.24
115	150			99	166	2.5	0.34	1.99	2.96	1.94	8.19
	150			99	166	2.5	0.34	1.99	2.96	1.94	7.59
123	159	8.3	5	104	176	2.5	0.34	1.99	2.96	1.94	8.49
128	167	8.3	5	109	186	2.5	0.34	1.99	2.96	1.94	10.5
135	179			114	201	2.3	0.37	1.80	2.70	1.80	13.5
	179	11.1	5	114	201	2.3	0.37	1.80	2.70	1.80	13.5
127	151			115	165	2	0.31	2.20	3.30	2.20	5.48
150	197			124	226	2.5	0.37	1.80	2.70	1.80	18.9
	197	13.9	6	124	226	2.5	0.37	1.80	2.70	1.80	18.8
165	215			134	246	2.5	0.35	1.90	2.90	1.80	23.3
	215			134	246	2.5	0.35	1.90	2.90	1.80	23.3
172	210	11.1	6	144	216	2.5	0.30	2.50	3.70	2.50	11.2
	232	16.7	6	148	262	3	0.36	1.88	2.79	1.83	28.6
	232	16.7	6	148	262	3	0.36	1.88	2.79	1.83	28.6
186	247	16.7	9	158	282	3	0.37	1.80	2.70	1.80	37.0
	270	16.7	9	158	280	3	0.42	1.69	2.51	1.65	41.8
203	265	16.7	9	168	302	3	0.37	1.80	2.70	1.80	44.6
201	249	13.9	5	174	276	2.5	0.27	2.50	3.70	2.50	22.5
	284	16.7	7	178	322	3	0.36	1.87	2.79	1.83	52.8
	284	22	8	178	322	3	0.35	1.90	2.90	1.80	60.6
	284	22	8	178	322	3	0.35	1.90	2.90	1.80	60.6
215	268	16.7	6	188	292	3	0.27	2.50	3.70	2.50	61.7
	292	22.3	12	188	342	3	0.41	1.65	2.45	1.61	69.0

Spherical Roller Bearing(Vibration Screen VB)

d 180~200 mm

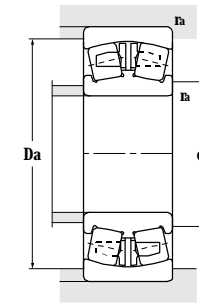
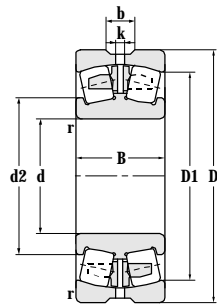

Principal dimensions				Basic load ratings		Limit speed ratings		Designations
d	D	B	r _{min}	C _r	C _{Or}	Grease	Oil	
mm				kN		r/min		
180	380	126	4	1620	2400	900	1200	22336Q1/VBW33
190	340	120	4	1420	2400	850	1100	23238KQ1/VBW33
	400	132	5	1800	2630	850	1100	22338Q1/VBW33
200	420	138	5	1910	2860	850	1100	22340Q1/VBW33

Other dimensions				Contact surface and chamfer dimensions			Calculation coefficient			Weight	
d1	D1	b	k	da	Da	ra	e	y1	y2		y0
mm				mm			mm			kg	
242	316	22.3	8	198	362	3	0.35	1.90	2.90	1.80	71.3
237	288	16.7	7	208	322	3	0.35	1.90	2.90	1.80	48
	334	22.3	8	212	378	4	0.35	1.90	2.90	1.80	82.2
269	350	22.3	8	222	398	4	0.35	1.90	2.90	1.80	97

Spherical Roller Bearing(Continuous Casting Bearing CB)

d 65-160 mm

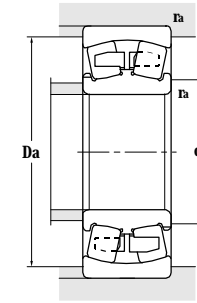
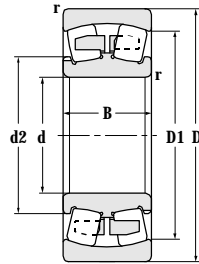
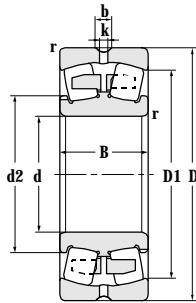

Principal dimensions				Basic load ratings		Limit speed ratings		Designations
d	D	B	r _{min}	C _r	C _{Or}	Grease	Oil	
mm				kN		r/min		
65	100	35	1.1	110	165	3800	4800	24013CB-2RS/HG2
75	115	40	1.1	158	240	2900	3500	24015CB/HG2W33
90	160	52.4	2	300	440	1900	2600	23218CB/HG2W33
95	170	43	2.1	275	370	2400	3200	22219CB/HG2W33
100	180	60.3	2.1	400	570	1700	2200	23220CB/HG2W33
110	180	69	2	410	660	1000	1400	24122CB/HG2W33
120	180	60	2	365	630	1600	2000	24024CB/HG2W33
	200	62	2	430	650	1900	2600	23124CB/HG2W33
130	200	69	2	470	820	1800	2400	24026CB/HG2W33
140	210	69	2	460	860	1800	2400	24028CB/HG2W33
160	240	80	2.1	640	1180	1100	1500	24032CB/HG2W33

Other dimensions				Contact surface and chamfer dimensions			Calculation coefficient			Weight	
d2	D1	b	k	da	Da	ra	e	y1	y2		y0
mm				mm			mm			kg	
75	87			74	90	1					0.966
88	101	5.5	3	82	106	1					1.48
111	137	5.7	3	101	149	2					4.5
120	149	8.4	4.5	107	158	2					4.29
125	153	8.4	4.5	112	168	2					6.44
131	154	5.5	3	120	170	2					6.95
138	158	5.5	4	130	170	2					5.53
	146	175	8.3	4.5	130	190	2				7.97
151	174	5.5	3	140	190	2					7.76
160	184	6	3	150	200	2					8.51
184	209	10	4.5	172	228	2					12.9

Spherical Roller Bearing(SDB)

d 75--220 mm

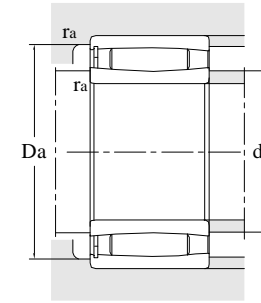
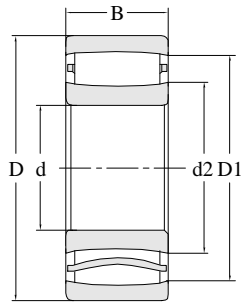
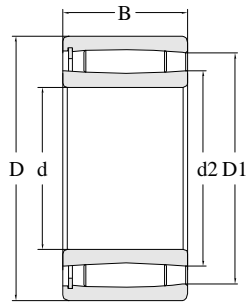

Principal dimensions				Basic load ratings		Limit speed ratings	Designations
d	D	B	r _{min}	C _r	C _{or}		
mm				kN		r/min	
75	105	40	1	204	325	1900	SDB5915V/HG2YAD
	105	40	1	204	325	1900	SDB5915V/YAD
	105	54	1	200	325	1600	SDB6915V-2RS/HG2
	105	54	1	200	325	1600	SDB6915V/HG2C9
85	120	46	1.1	275	465	1700	SDB5917V/YAD
90	125	46	1.1	200	400	1600	SDB5918V/C9
	125	46	1.1	200	400	1600	SDB5918V-2RS/C9
100	150	50	1.5	345	530	1400	SDB4020V/HG2W33AYAD
	150	67	1.5	495	865	1100	SDB5020V/C9YA7
120	180	60	2	510	850	1100	SDB4024V/HG2C9
	180	60	2	510	850	1100	SDB4024V/HG2W33A
	180	60	2	510	850	1100	SDB4024V/W33YAD
130	200	69	2	700	1085	850	SDB4026V/HG2YAD
	200	69	2	700	1100	850	SDB4026V/YAD
150	225	75	2.1	755	1330	750	SDB4030V/C9
160	240	80	2.1	890	1460	600	SDB4032V/HG2W33AYAD
220	340	90	3	1280	2030	220	SDB3044/C9

Other dimensions				Contact surface and chamfer dimensions			Calculation coefficient		Weight
d2	D1	b	k	da	Da	ra	k1	k2	
mm				mm			mm		kg
82	96			81	95	1	0.098	0.114	1.07
82	96			81	95	1	0.098	0.114	1.07
85	94			81	98	1	0.073	0.154	1.36
85	94			81	98	1	0.073	0.154	1.35
95	110			91	113	1	0.098	0.109	1.52
101	113			98	116	1	0.089	0.131	1.71
101	113			98	116	1	0.089	0.131	1.72
112	135	10	3	110	138	1.5	0.098	0.118	3.05
114	135			110	138	1.5	0.112	0.094	4.23
139	164			134	168	2	0.107	0.103	5.48
139	164	10	3	134	168	2	0.107	0.103	5.45
139	164	5.5	4	134	168	2	0.107	0.103	5.44
146	181			142	190	2	0.113	0.097	7.79
146	181			142	190	2	0.113	0.097	8.04
172	204			165	213	2	0.107	0.106	10.4
179	217	11	4	175	220	2	0.109	0.103	12.6
256	311			240	320	2.5	0.11	0.10	29.1

Spherical Roller Bearing(Adapter Sleeve)

d 60-200 mm

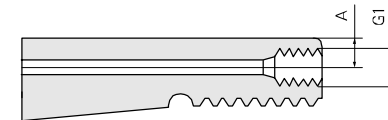
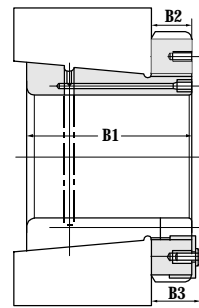
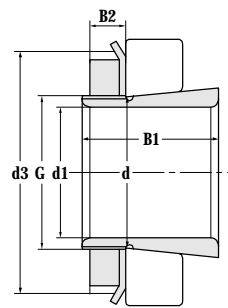

Principal dimensions								
d1	d	d3	B1	B2	B3	G	G1	A
mm								
60	65	85	65	14		M65x2		
70	80	105	46	17		M80x2		
	80	105	46	17		M80x2		
75	85	110	63	18		M85x2		
80	90	120	65	18		M90x2		
90	100	130	97	20		M100x2		
100	110	145	81	21		M110x2		
	110	145	105	21		M110x2		
110	120	145	72	22		M120x2		
	120	155	88	22		M120x2		
115	130	165	121	23		M130x2		
140	160	190	93	28		M160x3		
	160	210	119	28		M160x3		
	160	210	147	28		M160x3		
150	170	200	101	29		M170x3		
	170	220	122	29		M170x3		
160	180	210	109	30		M180x3		
	180	230	131	30		M180x3		
170	190	220	112	31		M190x3		
180	200	240	120	32		M200x3		
	200	250	150	32		M200x3		
200	220	260	126	30	41	Tr220x4	M6	4.2
	220	280	161	35		Tr220x4		

Designation	Lock nut	Locking device	Applicable hydraulic nut	Weight
Adapter sleeve with lock nut and locking devices.				
kg				
H2313	KM13	MB13	HMV13E	0.582
H216	KM16	MB16	HMV16E	0.966
H316	KM16	MB16	HMV16E	1.04
H317	KM17	MB17	HMV17E	1.17
H318	KM18	MB18	HMV18E	1.1
H2320	KM20	MB20	HMV20E	2.76
H3122	KM22	MB22	HMV22E	2.33
H2322	KM22	MB22	HMV22E	2.84
H3024	KML24	MBL24	HMV24E	1.95
H3124	KM24	MB24	HMV24E	2.39
H2326	KM26	MB26	HMV26E	4.72
H3032	KML32	MBL32	HMV32E	6.64
H3132	KM32	MB32	HMV32E	7.47
H2332	KM32	MB32	HMV32E	9.2
H3034	KML34	MBL34	HMV34E	6.31
H3134	KM34	MB34	HMV34E	8
H3036	KML36	MBL36	HMV36E	6.73
H3136	KM36	MB36	HMV36E	9.39
H3038	KML38	MBL38	HMV38E	7.62
H3040	KML40	MBL40	HMV40E	9.71
H3140	KM40	MB40	HMV40E	12
H3044	HML44	MSL44	HMV44E	11.2
H3144	HM44	MS44	HMV44E	15.3

Spherical Roller Bearing(Adapter Sleeve)

d 200~380 mm

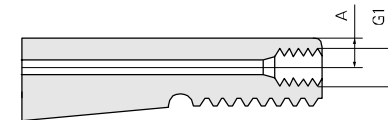
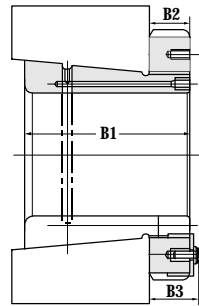
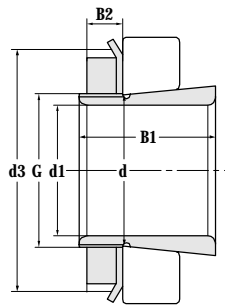

Principal dimensions								
d1	d	d3	B1	B2	B3	G	G1	A
mm								
200	220	280	161	35		Tr220x4	M6	4.2
	220	280	186	35		Tr220x4		
220	240	300	172	37		Tr240x4	M6	4.2
	240	300	172	37		Tr240x4		
240	260	310	116	34	46	Tr260x4	M6	4.2
	260	310	145	34	46	Tr260x4	M6	4.2
	260	330	190	39		Tr260x4	M6	4
	260	330	190	39		Tr260x4		
260	280	330	152	38	50	Tr280x4	M6	4.2
	280	350	195	38	51	Tr280x4	M6	4.2
	280	350	195	38	41	Tr280x4	M6	4.2
	280	350	224	41		Tr280x4		
280	300	360	168	42	54	Tr300x4	M6	4.2
	300	380	208	40	53	Tr300x4	M6	4.2
300	320	380	140	42	55	Tr320x5	M6	4
	320	400	226	42	56	Tr320x5	M6	4
	320	400	258	42	56	Tr320x5	M6	4
320	340	440	254	55	72	Tr340x5	M6	4
340	360	420	188	45	58	Tr360x5	M6	4
	360	460	259	58	75	Tr360x5	M6	4
360	380	450	193	48	62	Tr380x5	M6	4
	380	490	264	60	77	Tr380x5	M6	4
380	400	470	210	52	66	Tr400x5	M6	4
	400	520	272	62	82	Tr400x5	M6	4

Designation	Lock nut	Locking device	Applicable hydraulic nut	Weight
Adapter sleeve with lock nut and locking devices.				
kg				
OH3144XH H2344	HM44	MB44	HMV44E	14.9
	HM44	MB44	HMV44E	16.8
H3148 OH3148H	HM48	MB48	HMV48E	18.4
	HM48	MB48	HMV48E	16
OH3952H H3052 H3152 OH3152H	HML52	MSL48	HMV52E	14.8
	HML52	MSL48	HMV52E	16
	HM52	MB52	HMV52E	22.8
	HM52	MB52	HMV52E	23.3
H3056 H3156 OH3156H H2356	HML56	MSL56	HMV56E	18.4
	KM56	MS52	HMV56E	25.2
	HM56X2	MB56	HMV56E	25.9
	HM56	MB56	HMV56E	29.6
H3060 OH3160H	HML60	MSL60	HMV60E	24
	HM60	MS60	HMV60E	31.4
OH3964H OH3164H H3264	HML64	MSL64	HMV64E	21.4
	HM64	MS64	HMV64E	32.5
	HM64	MS64	HMV64E	40.8
OH3168H	HM68	MS68	HMV68E	52.4
OH3072H OH3172H	HML72	MSL72	HMV72E	20.6
	HM72	MS68	HMV72E	57.3
H3076 H3176	HML76	MSL76	HMV76E	43.5
	HM76	MS76	HMV76E	62.9
H3080 OH3180H	HML80	MSL76	HMV80E	43.5
	HM80	MS80	HMV80E	65

Spherical Roller Bearing(Withdrawal Sleeve)

d 95-1010 mm

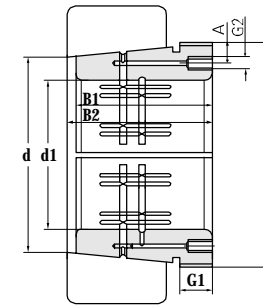
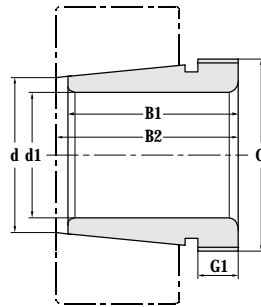

Principal dimensions							
d1	d	B1	B2	G	G1	G2	A
mm							
95	100	64	68	M110x2	11		
105	110	65	72	M120x2	11		
145	150	96	101	M160x3	15		
170	180	105	110	M200x3	17		
	180	116	122	M190x3	19		
200	220	130	136	Tr240x4	20		
220	240	154	161	Tr260x4	25		
	240	189	197	Tr260x4	30		
320	340	225	234	Tr360x5	33		
340	360	167	176	Tr380x5	30	G1/4	9
	269	289	289	Tr380x5	26	G1/4	9
360	380	170	180	Tr410x5	31	G1/4	9.5
400	420	186	196	Tr440x5	34		
440	460	202	213	Tr480x5	37		
460	480	295	307	Tr500x5	45	G1/4	9
510	530	225	235	Tr560x6	54		
540	560	250	261	Tr600x6	54		
560	580	180	190	Tr600x6	47		
	580	300	308	Tr620x6	60		
1010	1060	310	328	Tr1095x8	50	G1/4	15

Designation Withdrawal sleeve	Applicable nut for withdraw	Applicable hydraulic nut	Weight
			kg
AH3120	KM22	HMV22E	0.66
AH3122			0.76
AHX3130	KM32	HMV32E	1.8
AH2236	KM40		3.4
AHX3136	KM38	HMV38E	4.25
AH2244			9.23
AH3148	HM3052	HMV52E	15.9
AH2348	HM3052	HMV52E	15.9
AHX3168	HM3172	HMV72E	28.1
AOH3072	HM3076	HMV3076E	21
AOH24172	HM3176	HMV3076E	29.6
AOH3076			22.8
AHX3084	HM3088	HMV88E	26.9
AHX3092H	HM3096	HMV96E	34
AOH3196	HM31/500	HMV100E	60
AHX06/530			47.8
AH30/560-1			60.6
AH26/580			38
AH26/580-1			86
AOH239/1060			261

Tapered Roller Bearing

Product Characters:

The inner and outer rings of tapered roller bearings have tapered raceways. The tapered rollers are mounted between raceways. If extending the tapered surfaces, the sliding surfaces of cup and the inner ring and the rolling elements converge towards the same single point on the bearing axes. Tapered roller bearings can bear combined loads of radial and axial. The bearing's axial carrying load capacity varies with contact angle. The greater contact angle is, the bigger capacity will be. Tapered roller bearings belong to separable type bearings. The rollers, inner ring and cage consist of cones which can be mounted separately from cup.

These bearings can limit the axial displacement of either shaft or the housing in one direction. When it is given radial loads, the auxiliary axial force can be formed. It is suggested that two of the bearings be put in face-to face or back - to back arrangements in application. The cup and cones should be mounted relatively to their end surfaces.

These bearings are mainly used on automobile wheels (both fromer and rear), variable speed devices, differential mechanisms, pinion shafts, machine tool spindles, construction machines, large-sized agricultural machines, gear deceleration devices for railway vehicles, and the small deceleration devices for mill roll necks.

Product Types:

ZWZ manufacture both metric and inch-sized single-row, double-row and four-row tapered roller bearings.

- Single - row tapered roller bearings
These bearings can only limit the axial

displacement of either the shaft or the housing in one direction and can carry axial load in one direction. When given radial load, the axial force formed inside the bearing must be offset. It is suggested that two of the bearings be put in face-to face or back-to back arrangements in application.

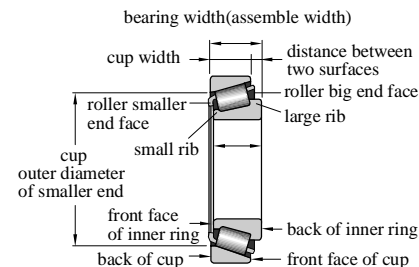
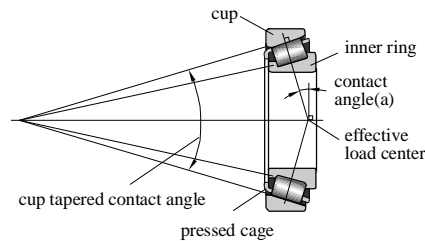

• Double-row tapered roller bearings

These bearings can carry axial load in two directions when they carry radial load. The axial displacement in two directions of the shaft and housing are limited within the bearings radial clearance range.

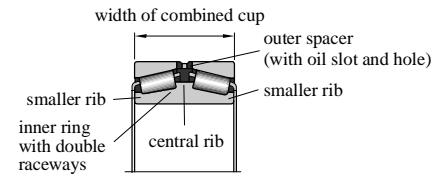
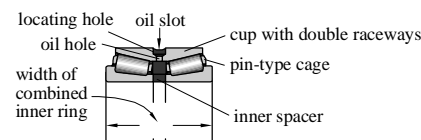

• Four-row tapered roller bearings

The functions and features of these bearings are basically the same as those of the double-row design. However, they can carry heavier load than the double-row tapered roller bearings, but with slightly slower rotation speed. These bearings are mainly applied to heavy machinery such as rolling mills, etc.

• Multi-sealed double row or four-row tapered roller bearings

ZWZ manufacture double - row and four - row tapered roller bearings with long life, multiple seals. Their seal performance is improved by amending traditional design method of full seal bearings, adopting new type seal structure. Compared to open type bearings, the life of multiple seals double - four row tapered bearings can be increased by 20% to 40%, and the lubricating consumption is decreased by 80%.

Multi-sealed double row or four-row tapered roller bearings are denoted with the suffix XRS.

Dimension Range

ZWZ tapered roller bearing basic dimensions are listed in the bearings dimensions table,
Single row tapered roller bearings:
 Bore diameter dimension range: 20 mm -1270mm
 Outer diameter dimension range: 40mm -1465mm
 Width range: 15mm-240mm

Double row tapered roller bearings:

Bore diameter dimension range: 38 mm- 1560mm
 Outer diameter dimension rang: 70mm-1800mm
 Width range: 50mm-460mm

Four-row tapered roller bearings:

Bore diameter dimension range: 130 mm-1600mm
 Outer diameter dimension range: 200mm-2000mm
 Width range: 150mm- 1150mm

Tolerance:

ZWZ manufacture metric tapered roller bearings have the normal tolerance class and also with P0, PX, P6, P5, P4, and P2 precision grade. All of tolerances values conform to GB307.1 Standard. The tolerances are listed in the preface tables.

ZWZ manufacture inch-sized tapered roller bearings have the normal tolerance class and also manufacture inch-sized tapered roller bearings with CL2, CL3, CL10 and CL00 tolerances

Radial clearance:

ZWZ single-row tapered roller bearings have clearance only after being mounted. And the clearance can be determined only when another bearing is located next to it in the opposite direction after adjusting. The radial clearance of double and four-row tapered roller bearing are listed in the preface tables.

Cage

Normally, tapered roller bearings use pressed basket shaped cages of steel sheet but for

Tapered Roller Bearing

bearings with greater dimensions, machined solid support shaped cages are also used.

1. When the bearings $OD \leq 650$ mm, pressed steel-sheet cage are used, the suffix of code name does not denote the structure of cage.

2. When the bearings $OD > 650$ mm, steel solid cages are used, the suffix of code name does not denote the structure of cage.

Allowable Angle Deviation

Usually for tapered roller bearings, there should be no misalignment between the shaft and the housing bore. When there is misalignment, the slope angle should not be greater than 2'.

Single-row tapered roller bearings**Equivalent dynamic load**

When $F_a/F_r \leq e$, $P=Fr$ [KN]

When $F_a/F_r > e$, $P=0.4 Fr+Y Fa$ [KN]

Single-row tapered roller bearings can be used in pairs (their basic dimensions may be different) and when calculating the equivalent dynamic load, the additional axial force caused by the radial load must be taken into

consideration and calculated in. The additional force S of single-row tapered roller bearings can be approximately calculated according to the following formula:

$$S = Fr / 2 Y$$

Equivalent static load**Single-row tapered roller bearings**

$$P_0 = 0.5Fr + Y_0Fa \quad [KN]$$

$$\text{If } P_0 < Fr, \quad P_0=Fr \quad [KN]$$

Double row and four-row tapered roller bearings**Equivalent dynamic load**

When $F_a/F_r \leq e$, $P=0 Fr + Y_1Fa$ [KN]

When $F_a/F_r > e$, $P=0.67Fr + Y_2Fa$ [KN]

Equivalent static load

$$P_0 = Fr + Y_0 Fa \quad [KN]$$

F_r and F_a indicate total load acted on single-row, double-row and four-row tapered roller bearings.

The factors e , Y , Y_1 , Y_2 , Y_0 are listed in the bearing dimension tables.

Suffix Code:

- A: 1. Tapered roller bearings, contact angle α , diameter of outer ring raceway D_1 disagrees with national standard. If there are two or more than two that are different with national standard α and D_1 in the same code, representing as A、A1、A2... in sequence.
- 2. Guided with outer ring
- A6: For inch tapered roller bearings, assembly chamfering is not in accordance with TIMKEN, when there are two or more than two that are different with TIMKEN assembly chamfering, then represent as A61、A62...
- B: 2. Tapered roller bearing, contact angle increases (increase an angle series)
- C: Paired tapered roller bearings, when axial clearance does not conform to ZWZ standard, attach average value of axial clearance after C directly
- /CR: Paired tapered roller bearings, when there is requirement for radial clearance, attach average value of radial clearance after CR directly
- D: Double-row tapered roller bearings, without inner space ring or outer space ring, inch tapered roller bearing without grinding end face, representing double-raceway inner ring or double-raceway outer ring
- /DB: Two tapered roller bearings used for the back to back paired mounting
- /DBY: Two single-row tapered roller bearing, for back to back mounting, with inner spacer, without outer spacer
- /DF: Two tapered roller bearings used for the face to face paired mounting
- D1: Double-row tapered roller bearing, with no inner spacer, grinded end face.
- /HA: Ring rolling elements and cage or only the ring and rolling elements are made from vacuum smelted bearing steel.
- /HC: Ring and rolling elements or only ring or rolling elements are made from case hardened steel (/HC-20Cr2Ni4A; /HC1-20Cr2Mn2MoA; /HC2-15Mn)
- /HCE: If the metric series bearing, indicates rings and rolling elements are choose high quality carburized steel
- /HCER: For the metric series bearing, only the roller is are made by high quality carburized steel
- /HCG2I: Indicates the outer ring & rolling elements are made by carburized steel, inner ring made by GCr18Mo
- /HCI: Indicates the inner ring made by carburized steel
- /HCO: Indicates the outer ring made by carburized steel
- /HCOI: Indicates only the outer ring & inner ring made by carburized steel
- /HCOR: Indicates only the outer ring & rolling element are made by carburized steel
- /HCR: To distinguish the bearing with same designations, only the rolling elements are made by carburized steel

Instruction for Code**Prefix code:**

F: For inch tapered roller bearings, add "F" in front of bearing series to represent bearing cage

G: For inch tapered roller bearings, represent inner space ring or outer space ring of bearing
Representing way of inner space ring: add "G-" in front of component code of inch bearing series

K: For inch tapered roller bearings, the bearing ring and rolling elements or only the ring is made up of high carbon chromium bearing steel

K1: For inch tapered roller bearings, the bearing ring and rolling elements or only the ring is made by 100CrMo7

K2: For inch tapered roller bearings, the bearing ring and rolling elements or only the ring is made by ZGCr15

R: For inch tapered roller bearings, add "R" in front of bearing series to represent tapered roller

Tapered Roller Bearing

Suffix Code:

- /HE: Ring, rolling elements and cage or only the ring and rolling elements are made by electroslag remelting bearing steel (military first grade steel) ZGCr15
- /HG: Made by ZGCr15. Ring and rolling elements or only ring are made by other bearing steel (/HG-5GrMnMo; /HG1-55SiMoVA; /HG2-GCr18Mo; /HG3-42CrMo/ HG4-GCr15SiMn)
- /HG2CR: Indicates the bearing ring is made by GCr18Mo, rolling elements is made by carburized steel
- /HG2I: If belongs to radial bearing, indicates the inner ring is made by GCr18Mo, outer ring & rolling elements is made by GCr15.
- /HG2O: Indicates the bearing outer ring made by GCr18Mo
- /HN: Ring and rolling elements are made by heat resistant steel (/HN-GCr4Mo4V; /HN1-Cr14Mo4; /HN2-Cr15Mo4V; /HN3-W18Cr4V)
- /HP: Ring and rolling elements are made from beryllium bronze or other anti-magnetic materials. When material is changed, it is indicated by the added digitals
- /HQ: Ring and rolling elements are made from the unusual materials (/HQ- plastic; /HQ1-ceramic alloy)
- /HU: Ring, rolling elements and cage or only the ring and rolling elements are made from the unhardened stainless steel 1Cr18Ni9Ti
- /HV: Ring, rolling elements and cage or only the ring and rolling elements are made from the unhardened stainless steel (/HV-9Cr18; /HV1-9Cr18Mo)
- K: Tapered bore bearing, conicity is 1: 12
- K30: Tapered bore bearing, conicity is 1: 30
- P: Bearing precision grade, the appended digital indicates specific precision grade
- R: Bearing with snap rib on outer ring (convex outer ring)
- RS: Bearing with frame system rubber seal ring (contact system)
- RS1: Bearing with frame system rubber seal ring (contact system), the material of seal ring is sulfured rubber
- RS2: Bearing with frame system rubber seal ring (contact system), the material of seal ring is fluoride rubber
- 2RS: Bearing with RS sealed on both sides
- 2RS1: Bearing with RS1 sealed on both sides
- 2RS2: Bearing with RS2 sealed on both sides
- RZ: Bearing with frame type rubber sealing ring (non-contact type)
- 2RZ: Bearing with RZ sealed on both sides
- S: Martensite quenching
- /SP: Ultra precision grade, dimension tolerance equals to P5, rotating precision equals to P4
- /S0: Bearing ring tempered in high temperature, which can reach 150°C

Suffix Code:

- /S1: Bearing ring tempered in high temperature, which can reach 200*
- /S2: Bearing ring tempered in high temperature, which can reach 250*
- /S3: Bearing ring tempered in high temperature, which can reach 300*
- /S4: Bearing ring tempered in high temperature, which can reach 350*
- SC: Radial bearing with outer cover
- T: When the assemble height dimension of the paired tapered roller bearing not conform to the standard specification, the assemble height dimension will be added directly after T
- V: Inch
- X1: Non-standard outer diameter
- X2: Non-standard width (height)
- X3: Non-standard outer diameter, width (height) (standard bore diameter)
- X4: Inner diameter select the integer of non-standard bearing, while inner diameter is not integer and have two and more decimal places, indicated by X4 as select integer of the figures
- XRS: Four-row tapered roller bearing, with multi sealed parts. (more than two sealings)
 - Y: Y Combines with another letter (such as YA, YB) or more digitals to identify the change of the non-series which can not be indicated with the present suffix code
 - YA: Structure change
 - YA1: Outside surface of outer ring has changed comparing to standard design
 - YA2: Bore of inner ring has changed comparing to the standard design
 - YA3: End face of bearing ring has changed comparing to the standard design
 - YA4: Raceway of bearing ring has changed comparing to the standard design
 - YA5: Bearing rolling elements has changed comparing to the standard design
 - YA6: Bearing mounting chamfer has changed comparing to the standard design
 - YA7: Bearing rib or flange has changed comparing to the standard design
 - YA8: Bearing cage structure changed
 - YA9: Bearing contact angle has changed comparing to the standard design
 - YA10: Double-row tapered roller bearing, inner spacer with oil groove and oil hole
 - YAB: Structure and technical specification has changed at the same time
 - YAD: One type of bearing has two or more changes on structure
 - YB: Technical specification has changed
 - YB1: Surface of bearing ring has plated coating
 - YB2: Bearing dimension and tolerance changed
 - YB3: Surface roughness of bearing ring changed
 - YB4: Heat treating specification (e.g. hardness) changed
 - YB5: Structure and position tolerance have special requirements
 - YBD: One type of bearing has two or more changes on technical specification
 - Z: Bearing with shield on one side
 - Z2: Bearing with shields on both sides

Single-row Tapered Roller Bearing(Metric)

d 20-30 mm

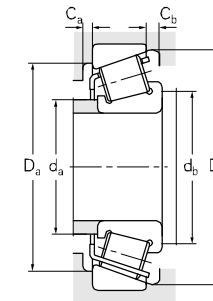
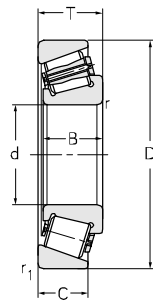
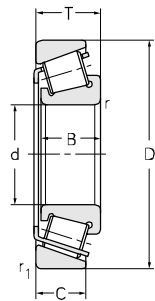

Principal dimensions									Basic load ratings		Limit speed ratings	
d	D	T	B	C	r _{radial}	r _{axial}	r _{1radial}	r _{1axial}	C _R	C _{OR}	Grease	Oil
mm												
									kN	r/min		
20	42	15	15	12	0.6	0.6	0.6	0.6	26.3	29.9	9500	12000
	47	19.25	18	15	1	1	1	1	27.5	31	7500	10000
	47	15	14	12	1	1	1	1	30.5	29.7	8000	11000
	47	15.25	14	12	1	1	1	1	30	31	8000	11000
	52	16.25	15	13	1.5	1.5	1.5	1.5	38.2	32.5	8000	11000
	52	22.25	21	18	1.5	1.5	1.5	1.5	50	45	7500	10000
25	47	15	15	11.5	0.6	0.6	0.6	0.6	29.3	36	7500	9500
	47	17	17	14	0.6	0.6	0.6	0.6	32.5	42.5	7500	9500
	52	22	22	18	1	1	1	1	52.9	56	7500	9500
	52	22	22	18	1	1	1	1	52.9	56	7500	9500
	52	19.25	18	16	1	1	1	1	40.5	46	7000	9500
	52	16.25	15	13	1	1	1	1	34.8	33.5	7500	9500
	52	16.25	15	13	1	1	1	1	34.8	33.5	7500	9500
	52	16.25	15	13	1	1	1	1	34.8	33.5	7500	9500
	62	18.25	17	13	1.5	1.5	1.5	1.5	48	47	9000	13000
	62	18.25	17	15	1.5	1.5	1.5	1.5	48	46.5	9000	13000
	62	18.25	17	13	1.5	1.5	1.5	1.5	42.5	46	5600	7500
	62	25.25	24	20	1.5	1.5	1.5	1.5	67	72.5	9000	13000
28	52	16	16	12	1	1	1	1	35.5	39.2	7100	8900
30	55	17	17	13	1	1	1	1	36	47	6700	9000
	62	21.25	20	17	1	1	1	1	57.3	65	6300	8500
	62	21.25	20	17	1	1	1	1	57	59.5	6300	8500
	62	25	25	19.5	1	1	1	1	70.5	75	5600	7500
72	28.75	27	23	1.5	1.5	1.5	1.5	86.2	84	5300	7000	
72	20.75	19	16	1.5	1.5	1.5	1.5	62.7	62.5	5600	7500	
72	20.75	19	16	1.5	1.5	1.5	1.5	62.7	62.5	5600	7500	
72	20.75	19	14	1.5	1.5	1.5	1.5	54	59.5	5600	7500	
72	20.75	20	14	1.5	1.5	1.5	1.5	54.5	59.5	5000	6700	

Designations	Abutment and fillet dimensions							Calculation coefficient				Weight
	da _{max}	db _{min}	Da _{min}	Da _{max}	Db _{min}	Ca _{min}	Cb _{min}	e	Y	Y0	a	
mm												
												kg
32004-DW	28	28	44	45	48	3	3.3	0.37	1.6	0.88	10	0.0987
32204	26	24	38	43	44	2	4.3	0.33	1.8	1	12	0.158
30204X2/P6XYB5	28	24	40	43	44	2.5	3	0.35	1.7	0.96	11	0.123
30204/YA8	28	24	40	43	45	2.5	3.3	0.35	1.7	0.96	11	0.124
30304	28	28	44	45	48	3	3.3	0.3	2	1.1	11	0.167
32304	26	27	43	45	48	3	4.5	0.3	2	1.1	13	0.238
32005-DW	34	32	47	55	59	3	5	0.43	1.39	0.77	11	0.11
33005	31	28	40	44	45	2	3	0.29	2.1	1.14	11	0.129
33205	30	29	42	48	50	2	4	0.35	1.7	0.94	14	0.216
33205-DW	30	29	42	48	50	2	4	0.35	1.7	0.94	14	0.216
32205	31	31	44	48	50	2	3.3	0.36	1.7	0.92	13	0.199
30205	31	31	44	46	49	2	3.3	0.37	1.6	0.88	12	0.16
30205/P6X	31	31	44	46	49	2	3.3	0.37	1.6	0.88	12	0.16
30205/YA8	32	29	43	48	49	2	3.3	0.37	1.6	0.88	12	0.166
30305	35	32	54	55	58	3	5.3	0.3	2	1.1	12	0.25
30305X2	35	33	53	55	58	2	3.3	0.3	2	1.1	13	0.267
31305	34	32	47	55	59	3	5	0.83	0.72	0.4	20	0.263
32305-DW	31	31	44	48	50	2	3.3	0.3	2	1.1	16	0.422
320/28	33	32	44	48	51	2	4	0.43	1.4	0.77	13	0.145
32006/P6XYB5	35	36	48	49	52	3	4	0.43	1.4	0.8	13	0.171
32206	36	36	52	56	58	2	4.3	0.37	1.6	0.88	15	0.356
32206-DZ	36	36	52	56	58	2	4.3	0.37	1.6	0.88	15	0.356
33206	37	34	51	58	60	2	5.5	0.34	1.8	0.97	16	0.343
32306	38	37	59	65	66	2	6	0.31	1.9	1.05	18	0.554
30306/HA	40	37	62	65	66	4	6	0.31	1.9	1.05	15	0.397
30306/HAP6X	40	37	62	65	66	4	6	0.31	1.9	1.05	15	0.397
31306	38	38	55	65	67	2	6.8	0.83	0.7	0.4	34	0.489
31306WB1	38	38	55	65	67	2	6.8	0.83	0.7	0.4	34	0.489

Single-row Tapered Roller Bearing(Metric)

d 30-40 mm

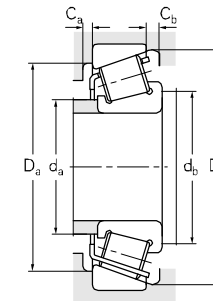
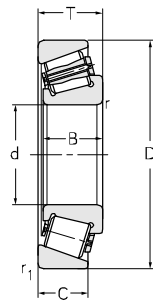
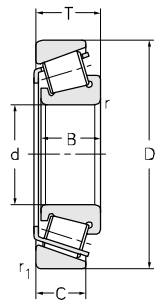

Principal dimensions					Basic load ratings				Limit speed ratings			
d	D	T	B	C	r _{radial}	r _{axial}	r _{1radial}	r _{1axial}	C _R	C _{OR}	Grease	Oil
											r/min	
30	72	20.75	19	14	1.5	1.5	1.5	1.5	54.5	59.5	5600	7500
	72	24	23	16.5	1.5	1.5	1.5	1.5	59	61	5000	6700
	72	24	23	16.5	1.5	1.5	1.5	1.5	59	61	5000	6700
35	62	18	18	14	1	1	1	1	42	52	6000	8000
	62	18	18	14	3.3	3.3	1	1	48	57	6000	8000
	65	18	18	14	3.5	3.5	1.2	1.2	35	41	5000	7000
	65	18	18	14	3.5	3.5	1.5	1.5	38.5	42	5000	7000
	72	24.25	23	19	1.5	1.5	1.5	1.5	75	80	5300	7000
	72	24.25	23	19	1.5	1.5	1.5	1.5	75	80	5300	7000
	72	18.25	17	15	1.5	1.5	1.5	1.5	57.3	56	5300	7000
	72	18.25	17	15	1.5	1.5	1.5	1.5	57.3	56	5300	7000
	80	18.25	17	15	1.5	1.5	1.5	1.5	54.5	60	5600	7500
	80	22.75	21	15	2	2	1.5	1.5	70	76	4500	6000
	80	32.75	31	25	2	2	1.5	1.5	94.5	94	4800	6300
	80	32.75	31	25	0.3	0.3	1.5	1.5	95	110	4800	6300
	80	32.75	31	25	2	2	1.5	1.5	94.1	110	4800	6300
	80	32.75	31	25	2	2	1.5	1.5	95	110	4800	6300
	80	29.15	28.5	22	2	2	2	2	93	112	4800	6300
	89	38	38	27.5	1	1	1.5	1.5	111	148	4800	6300
	89	38	38	27.5	1	1	1.5	1.5	111	148	4800	6300
36.512	90	35.25	33	27	2	2	1.5	1.5	114	148	4800	6300
37	92	35.3	34	26	0.5	0.5	1.5	1.5	121	138	4600	5800
39.7	90	25.4	22	21	0.8	0.8	0.8	0.8	78.5	94.5	4500	5700
40	73	21	21	15.5	1	1	1	1	59	74.5	5300	7000
	75	19	19	14.5	1	1	1	1	55	76	5000	6700
	75	26	26	20.5	1.5	1.5	1.5	1.5	90	104	5000	6700

Designations	Abutment and fillet dimensions						Calculation coefficient				Weight	
	da _{max}	db _{min}	Da _{min}	Da _{max}	Db _{min}	Ca _{min}	Cb _{min}	e	Y	Y0		a
mm												
31306B/HAP5	41	38	59	65	68	2	6.8	0.55	1.1	0.6	18	0.370
31306X2A-1-SG	39	38	56	65	67	2	7.5	0.62	0.97	0.53	21	0.455
31306X2A/HAP5-1	39	38	56	65	67	2	7.5	0.62	1	0.53	21	0.455
32007	40	41	54	56	59	4	4	0.45	1.3	0.73	15	0.384
32007/YA6	40	41	54	56	59	4	4	0.45	1.3	0.73	15	0.222
30607	42	47	55	65	62	2	4	0.38	1.6	0.88	14	0.229
30607-1	39	36	52	58	58	2	4	0.33	1.8	0.99	13	0.251
32207	42	42	61	65	68	2	5.3	0.37	1.6	0.88	17	0.452
32207/YA8	42	42	61	65	68	2	5.3	0.37	1.6	0.88	17	0.465
30207	44	42	62	65	67	3	3.3	0.37	1.6	0.88	15	0.318
30207-DZ	44	42	62	65	67	3	3.3	0.37	1.6	0.88	15	0.318
30207X1	47	44	68	73	75	3	5.5	0.37	1.6	0.88	17	0.43
31307	45	44	62	71	76	3	7.5	0.83	0.7	0.4	25	0.515
32307	43	44	66	71	74	4	8.5	0.31	1.9	1.05	20	0.755
32307A/HAP5	45	36	61	73	75	3	7.8	0.47	1.3	0.7	23	0.768
32307B	45	36	61	73	75	3	7.8	0.55	1.1	0.6	25	0.789
32307/HAP6X	43	44	66	71	74	4	8.5	0.31	1.9	1.05	20	0.755
32307X2A/YAB	43	44	66	71	74	4	8.5	0.55	1.1	0.6	23	0.697
32307X3A/HAP5	47	39	64	82	85	3	11	0.62	1	0.53	29	1.22
32307X3A-SG	47	39	64	82	85	3	11	0.62	1	0.53	29	1.22
323/36X4/YB2	48	42	64	84	85	3	8.3	0.55	1.1	0.6	28	1.18
306/37	48	40	69	87	86	4	9.3	0.55	1.1	0.6	27	1.19
306/39X4	58	43	74	85	85	2	4.4	0.4	1.49	0.82	23	0.769
32008X3	47	50	59	64	67	2	3	0.43	1.4	0.76	26	0.362
32008R-DZ	47	50	59	64	67	2	3	0.38	1.58	0.87	15	0.299
33108	65	47	65	68	71	4	5.5	0.35	1.7	0.9	18	0.499

Single-row Tapered Roller Bearing(Metric)

d 40-50 mm

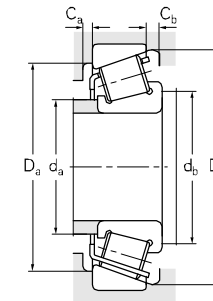
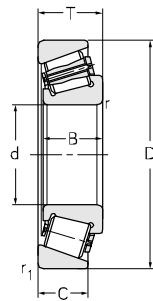
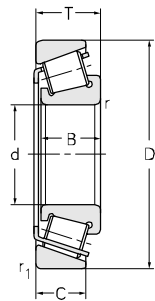

Principal dimensions					Basic load ratings				Limit speed ratings			
d	D	T	B	C	r _{radial}	r _{axial}	r _{1radial}	r _{1axial}	C _R	C _{OR}	Grease	Oil
										r/min		
40	80	30	29	23	2	2	2	2	103	120	4300	5600
	80	19.75	18	16	1.5	1.5	1.5	1.5	70	73	4800	6300
	90	25.25	23	17	2	2	1.5	1.5	71.5	77	4000	5300
	80	24.75	23	19	1.5	1.5	1.5	1.5	83.5	93	4800	6300
	80	24.75	23	19	3	3	1.5	1.5	83.5	94	4800	6300
	90	35.25	33	27	2	2	1.5	1.5	117	140	4000	5300
	90	35.25	33	27	2	2	1.5	1.5	114	148	4000	5300
	90	35.25	33	27	1.8	1.8	1.8	1.8	102	119	4000	5300
42	76	24	27.5	19.8	2	2	0.6	0.6	77.5	104	5000	6300
	76	23.8	27.5	19.8	0.7	0.7	0.1	0.1	77.5	104	5000	6300
45	75	20	20	15.5	1	1	1	1	66.4	80	4800	6300
	75	20	20	15.5	1	1	1	1	66.4	80	4800	6300
	75	20	20	15.5	1	1	1	1	66.4	80	4800	6300
	75	24	24	19	1	1	1	1	75.4	104	4800	6300
	80	26	26	20.5	1.5	1.5	1.5	1.5	95.3	118	4500	6000
	85	20.75	19	16	1.5	1.5	1.5	1.5	80.3	83	4500	6000
	85	24.75	23	19	1.5	1.5	1.5	1.5	90.3	105	4500	6000
	85	24.75	23.5	20	1.5	1.5	1.5	1.5	90.3	105	4500	6000
	100	27.25	25	22	2	2	1.5	1.5	123	120	4000	5300
	100	32	29	20.5	2	2	1.5	1.5	99	107	4000	5300
	100	27.25	25	18	2	2	1.5	1.5	105	102	3600	4800
	100	32	29	20.5	2	2	1.5	1.5	148	163	3400	4500
	100	38.25	36	30	2	2	1.5	1.5	153	174	3600	4800
	100	31.8	29	20.5	2	2	1.5	1.5	98	108	3600	4800
47	100	42.5	43	37	1.8	1.8	1.8	1.8	137	190	4000	5100
50	80	20	20	15.5	1	1	1	1	67.8	88	4500	6000
	80	20	20	15.5	1	1	1	1	67.8	88	4500	6000
	80	22	20	17.5	4	4	1.5	1.5	60	86	4500	6000
	80	24	24	19	1	1	1	1	77	111	4500	6000

Designations	Abutment and fillet dimensions						Calculation coefficient				Weight	
	da _{max}	db _{min}	Da _{min}	Da _{max}	Db _{min}	Ca _{min}	Cb _{min}	e	Y	Y0		a
mm												kg
33208X2A	49	49	65	72	77	3	7	0.43	1.4	0.77	21	0.669
30208	49	47	69	73	75	3	3.8	0.37	1.6	0.88	17	0.43
31308	48	49	71	81	87	4	9.5	0.83	0.7	0.4	29	0.731
32208	48	47	68	73	76	3	5.8	0.37	1.6	0.88	18	0.561
32208/YA6	48	47	68	73	76	3	5.8					0.561
32308	49	49	73	81	83	4	8.5	0.35	1.7	0.96	22	1.080
32308B	50	49	67	83	85	3	8.3	0.55	1.1	0.6	27	1.06
32308/YA8	49	49	73	81	83	4	8.5	0.35	1.7	0.96	22	1.020
306/42	48	48	65	73	73	2	4	0.28	2.16	1.19	16	0.479
306/42/P6XYB2	48	48	65	73	73	2	4	0.28	2.16	1.19	16	0.479
32009	52	49	65	71	73	3	6	0.39	1.5	0.84	17	0.343
32009/HA	52	49	65	71	73	3	6	0.39	1.5	0.84	17	0.343
32009/P6X	52	49	65	71	73	3	6	0.39	1.5	0.84	17	0.343
33009	50	48	66	72	72	3	5	0.29	2.04	1.12	16	0.414
33109R	52	52	69	73	77	4	5.5	0.37	1.6	0.9	19	0.538
30209	53	52	74	78	80	3	5	0.4	1.5	0.81	18	0.464
32209	53	52	73	78	81	3	5.8	0.4	1.5	0.81	20	0.576
32209X2A	53	53	69	78	78	3	4.8	0.4	1.5	0.83	19	0.621
30309	59	54	86	91	94	4	8.5	0.35	1.7	0.96	21	0.987
30309X2B	56	54	77	93	95	4	12	0.72	0.8	0.46	30	1.08
31309	54	54	79	91	96	4	9.5	0.83	0.7	0.4	32	0.977
31309X2	55	54	75	93	95	3	12	0.81	0.7	0.41	33	1.16
32309	56	54	82	91	93	4	8.5	0.35	1.7	0.96	25	1.44
32309X2A	56	54	77	93	95	4	11	0.72	0.8	0.46	30	1.14
306/47	55	54	80	93	94	3	5.5	0.31	1.94	1.07	27	1.66
32010	57	54	70	76	78	4	4.5	0.42	1.4	0.78	18	0.381
32010-AAM/P6	57	54	70	76	78	4	4.5	0.42	1.4	0.78	18	0.386
32010X2A/HAP5-1	57	64	70	73	78	4	4.5	0.42	1.4	0.78	19	0.388
33010	55	58	70	77	76	4	4.5	0.32	1.9	1.04	17	0.442

Single-row Tapered Roller Bearing(Metric)

d 50-55 mm

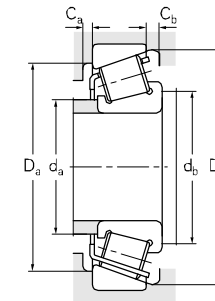
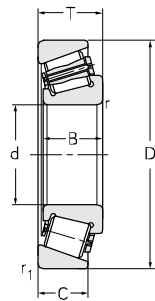
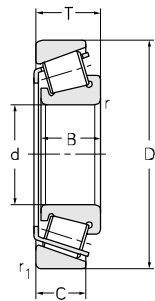

Principal dimensions					Basic load ratings				Limit speed ratings			
d	D	T	B	C	r _{radial}	r _{axial}	r _{1radial}	r _{1axial}	C _R	C _{OR}	Grease	Oil
											r/min	
50	82	21.5	21.5	17	3	3	0.5	0.5	81.6	100	3200	4300
	83	20.5	20.5	15.5	4	4	1	1	66	91	4500	6000
	83	20.5	20.5	15.5	4	4	1	1	66	91	4500	6000
	85	26	26	20	1.5	1.5	1.5	1.5	98.7	122	4400	5500
	90	32	32	24.5	1.5	1.5	1.5	1.5	119	160	3800	5000
	90	21.75	20	17	1.5	1.5	1.5	1.5	84.9	91.5	4300	5600
	90	23.75	20	19	1.5	1.5	1.5	1.5	79.5	96.5	4200	5500
	90	24.75	23	19	1.5	1.5	1.5	1.5	94	100	4300	5600
	90	25	23	19	1.3	1.3	1.3	1.3	62	77	4300	5600
	110	29.25	27	23	2.5	2.5	2	2	141	140	3600	4800
110	29.25	27	23	2.5	2.5	2.5	2.5	141	140	3600	4800	
110	29.25	27	19	2.5	2.5	2	2	110	124	3200	4300	
110	42.25	40	33	2.5	2.5	2	2	173	214	3600	4800	
110	42.25	40	33	2.3	2.3	2.3	2.3	173	214	3600	4800	
50.8	100	35	35	29	2	2	2	2	119	171	3900	4900
55	90	27	27	21	1.5	1.5	1.5	1.5	108	147	4000	5300
	90	23	23	17.5	1.5	1.5	1.5	1.5	92.4	116	4000	5300
	95	30	30	23	2	2.5	2	2.5	110	163	4000	5300
	95	30	30	23	1.5	1.5	1.5	1.5	100	163	3800	5000
	100	26.75	25	21	2	2	1.5	1.5	108	133	3800	5000
	100	26.75	25	21	2	2	1.5	1.5	98	133	3800	5000
	100	35	35	27	2	2	1.5	1.5	136	190	3400	4500
	100	35	35	27	2	2	1.5	1.5	136	190	3400	4500
	100	32	31	24.5	2	2	2	2	142	174	3400	4500
	100	22.75	21	18	2	2	1.5	1.5	102.8	106	3800	5000
100	22.75	21	18	2	2	1.5	1.5	102.8	106	4000	5300	
100	26.75	25	21	6	6	1.5	1.5	108	133	3800	5000	
120	31.5	29	25	2.5	2.5	2	2	165	163	3200	4300	
120	31.5	29	25	2.5	2.5	2	2	165	163	3200	4300	

Designations	Abutment and fillet dimensions						Calculation coefficient				Weight	
	da _{max}	db _{min}	Da _{min}	Da _{max}	Db _{min}	Ca _{min}	Cb _{min}	e	Y	Y0		a
mm												
30610	57	62	72	82	79	3	4.5	0.31	2	1.08	16	0.331
32010X3A/HAP5	57	64	73	79	80	4	5	0.36	1.7	0.92	17	0.430
32010X3A-SG	57	64	73	79	80	4	5	0.36	1.7	0.92	17	0.43
33110	56	55	72	80	82	4	6	0.41	1.46	0.8	20	0.581
33210	57	58	75	83	88	3	7.5	0.41	1.5	0.8	23	1.17
30210	58	57	79	83	86	3	5	0.42	1.4	0.79	20	0.55
30210X2-HQ	57	57	78	83	86	3	5.8	0.42	1.4	0.79	21	0.576
32210	58	57	78	83	85	3	5.5	0.43	1.4	0.8	21	0.640
32210A	60	59	76	90	86	3	6	0.42	1.4	0.78	21	0.612
30310-1	65	60	95	100	103	4	6	0.35	1.74	0.96	23	1.26
30310	65	60	95	100	103	4	6	0.35	1.7	0.96	23	1.26
31310	63	10	86	102	104	3	10	0.83	0.7	0.4	35	1.25
32310	61	60	90	100	102	5	9.5	0.35	1.7	0.96	27	1.26
32310/YA6	64	51	89	110	103	4	9.3	0.35	1.7	0.96	27	1.97
306/50.8	61	57	84	94	95	4	6	0.3	2	1.1	23	1.27
33011	62	65	78	83	87	4.5	5.5	0.31	1.92	1.06	19	0.839
32011	64	63	79	83	88	4.5	5.5	0.41	1.5	0.81	20	0.564
33111	64	63	81	88	92	3	7	0.37	1.6	0.88	22	0.881
33111/HA	64	63	81	88	92	3	7	0.37	1.6	0.88	22	0.881
32211	62	64	87	91	95	4	5.7	0.4	1.5	0.81	22	0.878
32211/HAP6X	62	64	87	91	95	4	5.7	0.4	1.5	0.81	22	0.878
33211	63	64	85	93	96	6	8	0.4	1.5	0.8	25	1.17
33211/HAP6X	63	64	85	93	96	6	8	0.4	1.5	0.8	25	1.17
33211X2A	64	64	85	92	97	4.5	7.5	0.4	1.5	0.81	24	1.01
30211	64	64	88	91	95	4	5	0.4	1.5	0.81	21	0.713
30211/YA	65	64	87	93	95	3	4.8	0.4	1.5	0.81	21	0.689
32211/YA6	65	74	85	93	95	3	5.8	0.4	1.5	0.81	22	0.875
30311	70	65	104	110	112	4	6.5	0.35	1.7	0.96	25	1.65
30311R	70	65	104	110	112	4	6.5	0.35	1.7	0.96	25	1.71

Single-row Tapered Roller Bearing(Metric)

d 55-65 mm

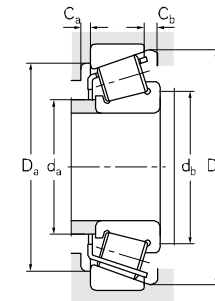
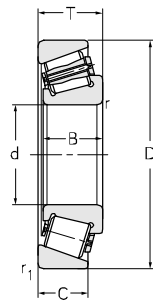
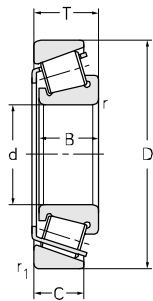

Principal dimensions					Basic load ratings				Limit speed ratings			
d	D	T	B	C	r _{radial}	r _{axial}	r _{1radial}	r _{1axial}	C _R	C _{OR}	Grease	Oil
											r/min	
55	120	31.5	29	21	2.5	2.5	2	2	155	166	2800	3800
	120	31.5	29	21	2.5	2.5	2	2	141	166	2800	3800
	120	31.5	29	21	2.5	2.5	2	2	135	139	2800	3800
	120	31.5	29	21	2.5	2.5	2	2	138	162	2800	3800
	120	45.5	43	35	2.5	2.5	2	2	248	280	3000	4000
	120	45.5	43	35	2.5	2.5	2	2	240	283	3000	4000
	120	45.5	44	35	2.5	2.5	2	2	252	286	3000	4000
	120	45.5	43	35	7	7	2	2	248	280	3000	4000
	120	31.5	29	25	2.5	2.5	2	2	165	163	3200	4300
	125	37	36	25	3	3	2	2	148	172	2800	3800
	130	36.25	33	22	3	3	2	2	165	175	3200	4000
	60	85	17	17	14	1	1	1	1	40	65	3900
85		17	17	14	1	1	1	1	40	65	3900	5100
85		17	16	14	1	1	1	1	42.5	67.5	3900	5100
95		27	27	21	1.5	1.5	1.5	1.5	104	143	3800	5000
95		23	23	17.5	2	2.5	2	2.5	93.5	122	3800	5000
95		27	27	21	1.5	1.5	1.5	1.5	104	143	3800	5000
110		23.75	22	19	2	2	1.5	1.5	111	114	3400	4500
110		29.75	28	24	2	2	1.5	1.5	133	170	3400	4500
110		29.75	28	24	2	2	1.5	1.5	133	170	3400	4500
110		29.75	28	24	2.5	2.5	2.5	2.5	133	170	3400	4500
110		38	38	29	2	2	1.5	1.5	168	235	3000	4000
115		40	39	33	4	4	3	3	193	204	3200	4300
130	33.5	31	26	3	3	2.5	2.5	163	185	3000	4000	
130	48.5	46	37	3	3	2.5	2.5	229	289	2600	3600	
130	33.5	31	22	3	3	2.5	2.5	138	155	2600	3600	
140	42	41	28	3	3	2.5	2.5	187	225	2600	3600	
150	51	51	38	4	4	3	3	260	370	2800	3500	
65	100	23	23	17.5	1.5	1.5	1.5	1.5	94.8	127	3400	4500
	100	23	23	17.5	1.5	1.5	1.5	1.5	94.8	127	3400	4500

Designations	Abutment and fillet dimensions						Calculation coefficient				Weight		
	da _{max}	db _{min}	Da _{min}	Da _{max}	Db _{min}	Ca _{min}	Cb _{min}	e	Y	Y0		a	
mm													
31311	68	65	92	112	112	3	11	0.83	0.7	0.4	38	1.78	
	31311-SG	65	92	112	112	3	11	0.83	0.7	0.4	38	1.78	
	31311/YA8	68	65	92	112	112	3	11	0.83	0.7	0.4	38	1.71
	31311/YB4	68	65	92	112	112	3	11	0.83	0.7	0.4	38	1.71
32311	68	65	99	110	111	5	11	0.35	1.7	0.96	29	2.43	
	32311A	66	65	99	110	111	5	11	0.55	1.1	0.6	230	2.51
	32311X2A1	66	65	99	112	111	5	10.5	0.35	1.7	0.9	29	2.43
	32311/YA6	68	65	99	110	111	5	11	0.35	1.7	0.96	29	2.43
	30311X3R	66	65	104	110	112	4	6.5	0.35	1.7	0.96	25	1.84
	30611B	70	67	95	117	117	3	12	0.73	0.8	0.45	38	2.1
	30611	69	67	95	117	117	3	12	0.83	0.730	0.4	41	2.16
	69	65	68	76	81	79	4	3	0.38	1.6	0.87	17	0.284
32912	65	68	76	81	79	4	3	0.38	1.6	0.87	17	0.285	
32912/P6-GKN	65	68	76	81	79	4	3	0.38	1.6	0.87	17	0.285	
32912X2A	65	68	76	81	79	4	3	0.38	1.6	0.87	17	0.277	
33012	67	67	85	88	90	5	6	0.33	1.8	1	20	0.688	
	32012	68	68	83	88	92	5	5.5	0.4	1.4	0.77	21	0.597
	33012-RS	67	67	85	88	90	5	6	0.33	1.8	1	20	0.727
30212	69	69	96	101	103	4	5	0.4	1.5	0.81	23	0.923	
	32212	69	68	95	101	104	4	5.8	0.4	1.5	0.81	25	1.26
	32212/HAP6X	69	68	95	101	104	4	5.8	0.4	1.5	0.81	25	1.26
	32212X3R/YA6	69	68	95	101	104	4	5.8	0.4	1.480	0.81	25	1.33
	33212	69	68	93	103	105	6	9	0.4	1.5	0.8	27	1.51
33212X3	70	71	98	104	109	6	7	0.33	1.8	1	28	1.81	
	30312	76	72	112	118	121	3.5	7.5	0.35	1.7	0.96	26	1.96
	32312	72	72	107	118	122	6	12	0.35	1.7	0.96	31	2.90
	31312	69	72	103	118	124	5	12	0.83	0.7	0.4	41	1.92
	31312X3	78	72	106	131	130	5	14	0.73	0.8	0.45	42	3.42
	30612	77	71	105	140	142	5	13	0.76	0.790	0.43	49	4.76
32013	72	72	90	93	97	4	5.5	0.46	1.3	0.7	22	0.612	
	32013/P6X	72	72	90	93	97	4	5.5	0.46	1.3	0.7	22	0.612

Single-row Tapered Roller Bearing(Metric)

d 65 mm

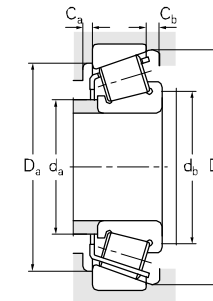
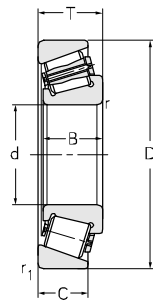
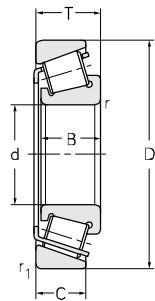

Principal dimensions					Basic load ratings				Limit speed ratings			
d	D	T	B	C	r _{radial}	r _{axial}	r _{1radial}	r _{1axial}	C _r	C _{0r}	Grease	Oil
											r/min	
											kN	
65	100	23.3	22	19	1.5	1.5	1.5	1.5	81	116	3400	4500
	100	23.3	22	19	1.5	1.5	1.5	1.5	73.5	116	3400	4500
	100	27	27	21	1.5	1.5	1.5	1.5	108	158	3400	4500
	110	34	34	26.5	1.5	1.5	1.5	1.5	157	220	3200	4300
	110	30.5	30	24	3	4	1.8	1.8	79	166	3200	4300
	110	34	34	26.5	1.5	1.5	1.5	1.5	157	220	3200	4300
	120	41	41	32	2	2	1.5	1.5	222	282	2800	3800
	120	41	41	32	2	2	1.5	1.5	191	270	2800	3800
	120	41	41	32	2	2	1.5	1.5	191	270	2800	3800
	120	32.75	31	27	2	2	1.5	1.5	151	192	3000	4000
	120	33	31	27	1.8	1.8	1.8	1.8	130	163	3000	4000
	120	24.75	23	20	2	2	1.5	1.5	131	134	3000	4000
130	45	43	35	7	7	2	2	223	298	2800	3800	
130	51	48	39	2.5	2.5	2.5	2.5	235	320	2400	3400	
130	51	48	39	3	3	2.5	2.5	245	335	2400	3400	
140	51	48	39	6	6	3.5	3.5	264	335	2200	3200	
140	36	33	28	3	3	2.5	2.5	192	228	2600	3600	
140	40	37	30	3	3	2.5	2.5	192	255	2600	3600	
140	40	39	26	3	3	5	5	202	237	2600	3600	
140	36	33	28	3	3	6	6	192	228	2600	3600	
140	36	33	28	6	6	2.5	2.5	192	228	2600	3600	
140	36	33	28	6	6	2.5	2.5	192	228	2600	3600	
140	36	33	23	3	3	2.5	2.5	171	198	2800	3800	
140	36	33	23	3	3	2.5	2.5	190	193	2600	3600	
140	36	33	23	3.8	5	2.5	2.5	191	194	2800	3800	
140	36	33	23	3	3	2.5	2.5	192	195	2200	3200	
140	51	48	39	3	3	2.5	2.5	264	335	2400	3400	
140	51	48	39	3	3	2.5	2.5	253	350	2400	3400	
140	36	33	23	3	3	2.5	2.5	193	196	2200	3200	

Designations	Abutment and fillet dimensions						Calculation coefficient				Weight	
	da _{max}	db _{min}	Da _{min}	Da _{max}	Db _{min}	Ca _{min}	Cb _{min}	e	Y	Y0		a
											kg	
											mm	
32013X2	72	72	90	93	97	4	5.5	0.35	1.7	0.94	20	0.629
32013X2A	72	72	90	93	97	4	5.5	0.35	1.7	0.94	20	0.629
33013	72	73	87	93	97	3.5	6	0.3	1.7	0.95	21	0.732
33113	76	73	94	103	107	3.5	7.5	0.39	1.6	0.85	26	1.30
33113X2	75	77	93	110	105	3.5	6.2	0.39	1.6	0.85	25	1.17
33113/YB2	76	73	94	103	107	3.5	7.5	0.39	1.6	0.85	26	1.30
33213	75	74	102	113	115	6	9	0.4	1.5	0.8	29	2.00
33213/HA	75	74	102	113	115	6	9	0.4	1.5	0.8	29	2.00
33213/YB2	75	74	102	113	115	6	9	0.4	1.5	0.8	29	2.00
32213	75	74	104	111	115	4	5.8	0.4	1.5	0.81	28	1.58
32213A/YA6	75	74	104	111	115	3.5	6	0.37	1.6	0.89	26	1.50
30213	77	74	106	111	114	4	5	0.4	1.5	0.81	24	1.14
30613	80	66	108	122	122	3.5	10	0.33	1.8	0.99	30	2.64
32313X1	79	75	107	121	122	5	12	0.33	1.8	0.99	32	3.01
32313X1A	80	77	107	121	124	5	12	0.35	1.7	0.93	33	2.93
32313/YA6	80	77	107	121	124	5	12	0.35	1.7	0.96	33	3.68
30313	83	72	120	131	131	3.5	8	0.35	1.7	0.96	28	2.49
30313X2A	83	72	120	131	131	3.5	8	0.47	1.28	0.7	34	2.84
30313X2/YA6	80	77	109	132	133	3.5	14	0.73	0.8	0.45	42	2.65
30313/YA6-1	86	77	120	122	131	5	8	0.35	1.7	0.96	28	2.49
30313/YA6	86	84	120	131	131	5	8	0.35	1.7	0.96	28	2.49
30313/YA6-2	86	84	120	131	131	5	8	0.35	1.7	0.96	28	2.49
31313	75	77	111	128	134	5	13	0.83	0.7	0.4	44	2.46
31313/YA5	84	77	122	128	130	5	8	0.35	1.7	0.9	28	2.45
31313/YA6	75	77	111	128	134	5	13	0.83	0.7	0.4	44	2.45
31313/YB4	80	77	111	128	132	5	13	0.83	0.72	0.4	42	2.46
32313	79	77	117	128	131	6	12	0.35	1.7	0.96	33	3.68
32313A	80	77	117	128	130	6	12	0.35	1.7	0.9	33	3.72
31313-ZQ/P6X	80	77	111	128	132	5	13	0.83	0.72	0.4	44	2.38

Single-row Tapered Roller Bearing(Metric)

d 65-70 mm

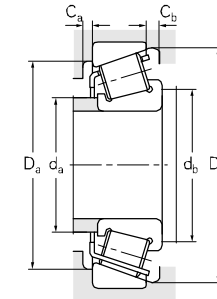
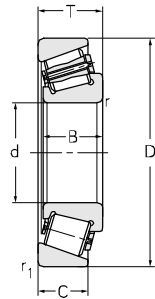
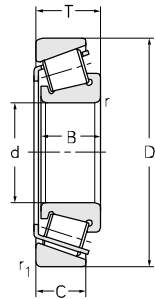

Principal dimensions					Basic load ratings				Limit speed ratings			
d	D	T	B	C	r _{radial}	r _{axial}	r _{1radial}	r _{1axial}	C _r	C _{Or}	Grease	Oil
											r/min	
65	150	53.5	54	44.5	2.3	2.3	2.3	2.3	296	390	2400	3400
	152	48	45.5	35	2.5	2.5	3	3	200	286	2400	3400
70	100	20	20	16	1	1	1	1	70.5	114	3000	4000
	100	20	19	16	1	1	1	1	60.5	97	3000	4000
	110	31	31	25.5	1.5	1.5	1.5	1.5	128	196	3000	4000
	110	25	25	19	1.5	1.5	1.5	1.5	115	152	3000	4000
	110	25	25	19	1.5	1.5	1.5	1.5	115	152	3000	4000
	120	33	33	27	2	2	2	2	158	220	3000	4000
	120	45	42	37	2.5	2.5	2.5	2.5	138	198	3000	4000
	120	45	42	37	2.5	2.5	2.5	2.5	138	198	3000	4000
	125	33.25	31	27	2	2	1.5	1.5	170	227	2800	3800
	125	33.25	31	27	2.5	2.5	2.5	2.5	201	248	2800	3800
125	26.25	24	21	2	2	1.5	1.5	124	156	3000	4000	
130	57	56	35	10.5	11	1.5	1.5	250	345	3000	4000	
130	57	56	35	SP	SP	1.5	1.5	250	345	3000	4000	
145	59	59	47	8.5	8.5	2.5	2.5	340	495	2500	3600	
150	54	51	42	6	6	2.5	2.5	305	395	2200	3200	
150	54	51	42	3	3	2.5	2.5	315	400	2200	3200	
150	54	51	42	6	6	2.5	2.5	315	410	2200	3200	
150	54	51	42	6	6	2.5	2.5	305	395	2200	3200	
150	38	35	30	3	3	2.5	2.5	223	262	2400	3400	
150	38	35	30	3	3	0.5	0.5	226	267	2400	3400	
150	41	35	33	3	3	0.5	0.5	226	267	2400	3400	
150	38	35	30	8.5	8.5	2.5	2.5	226	267	2400	3400	
150	38	35	25	3	3	2.5	2.5	214	220	2400	3400	
150	38	35	25	3	3	2.5	2.5	214	220	2000	3000	
150	38	35	25	3	3	2.5	2.5	214	220	2000	3000	
150	54	51	42	3	3	2.5	2.5	300	425	2200	3200	
150	54	51	42	3	3	2.5	2.5	305	390	2200	3200	
150	38	35	25	3	3	2.5	2.5	214	220	2000	3000	

Designations	Abutment and fillet dimensions						Calculation coefficient				Weight		
	da _{max}	db _{min}	Da _{min}	Da _{max}	Db _{min}	Ca _{min}	Cb _{min}	e	Y	Y0		a	
mm													kg
30613-1	86	75	117	150	137	3.5	9	0.36	1.7	0.9	37	4.43	
31313X3A/P6XYA6	75	77	111	128	134	5	13	1.05	0.57	0.31	60	4.32	
32914	76	76	90	96	96	5	4	0.32	1.9	1.05	18	0.475	
32914X2A	77	74	90	96	96	5	4	0.36	1.7	0.92	19	0.477	
33014	77	75	97	105	107	3	5.5	0.28	2.11	1.16	22	1.09	
32014	93	78	112	103	125	5	6	0.43	1.4	0.76	26	0.972	
32014/YA8	93	78	112	103	125	5	6	0.43	1.4	0.76	26	0.993	
33114X2A/YA6	81	79	104	112	113	5	6	0.28	2.2	1.19	23	1.51	
30614R	79	80	99	111	115	3.5	8	0.39	1.5	0.84	32	1.94	
30614	79	80	99	111	115	3.5	8	0.39	1.5	0.84	32	1.89	
32214	79	79	106	118	120	4	6.3	0.42	1.4	0.79	29	1.66	
32214/YA6	81	80	106	116	120	5	6.3	0.42	1.4	0.79	29	1.66	
30214	81	69	110	116	118	4	5.3	0.42	1.4	0.79	26	1.29	
30214X3/YA6	82	71	109	123	124	5	22	0.33	1.8	0.99	30	2.92	
30214X3/YA6-1	82	71	109	123	124	5	22	0.33	1.8	0.99	30	2.83	
32314X3A	78	82	113	130	130	5	13	0.44	1.4	0.4	47	4.5	
32314/YA6	88	89	123	141	140	5	12	0.35	1.7	0.96	36	4.38	
32314/YA6-1	88	89	123	141	140	5	12	0.35	1.7	0.96	36	4.33	
32314/YA6-2	88	89	123	141	140	5	12	0.35	1.7	0.96	36	4.33	
32314/YA6	88	89	123	141	140	5	12	0.35	1.7	0.96	36	4.38	
30314	89	82	130	138	141	5	8	0.35	1.7	0.96	30	3.08	
30314N	89	82	130	138	141	5	8	0.35	1.74	0.96	30	2.96	
30314X2N/YB2	89	82	130	138	141	5	8	0.35	1.74	0.96	33	3.11	
30314/YA6	92	71	128	141	140	5	8	0.35	1.7	0.96	30	3.08	
31314	78	82	118	138	140	5	13	0.83	0.7	0.4	47	2.87	
31314/HC3	85	82	118	138	141	5	13	0.83	0.72	0.4	45	2.87	
31314/HC4	85	82	118	138	141	5	13	0.83	0.72	0.4	46	2.87	
32314B	84	82	125	138	141	6	12	0.55	1.1	0.6	45	4.54	
32314	84	82	125	138	141	6	12	0.35	1.7	0.96	36	4.38	
31314-SG	85	82	118	138	141	5	13	0.83	0.72	0.4	46	2.87	

Single-row Tapered Roller Bearing(Metric)

d 70-75 mm

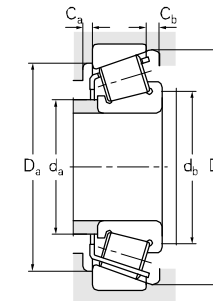
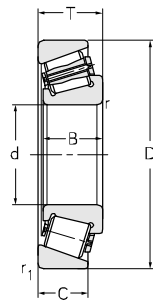
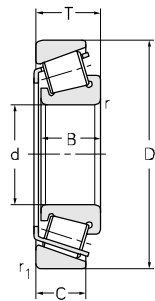

Principal dimensions					Basic load ratings				Limit speed ratings			
d	D	T	B	C	r _{radial}	r _{axial}	r _{1radial}	r _{1axial}	C _R	C _{OR}	Grease	Oil
											r/min	
70	165	57	57	40	6	6	3	3	315	410	2000	3000
	165	57	57	43	4	4	3	3	325	430	2000	3000
75	115	31	31	25.5	1.5	1.5	1.5	1.5	130	213	3000	4000
	115	35	35	25.5	1.5	1.5	1.5	1.5	133	221	3000	4000
	115	25	25	19	1.5	1.5	1.5	1.5	120	163	3000	4000
	125	37	37	29	2	2	1.5	1.5	174	275	2800	3800
	125	37	37	29	4	4	1.5	1.5	174	275	2800	3800
	130	41	41	31	2	2	1.5	1.5	208	300	2600	3600
	130	27.25	25	22	2	2	1.5	1.5	139	175	2800	3800
	130	33.25	31	27	2	2	1.5	1.5	185	253	2600	3600
	130	33.25	31	27	1.8	1.8	1.8	1.8	185	184	2600	3600
	130	33.5	31	27	1.8	1.8	1.8	1.8	139	184	2600	3600
	130	33.25	31	27	3	3	2.5	2.5	185	253	2600	3600
	130	33.25	31	27	2	2	1.5	1.5	185	253	2600	3600
	130	33.25	31	27	2	2	1.5	1.5	185	253	2600	3600
	135	44.5	45	35	2.3	2.3	2.3	2.3	193	277	2600	3600
	135	44	45	35	3	3	2.5	2.5	200	292	2600	3600
	135	44	45	35	3	3	2.5	2.5	200	292	2600	3600
	150	59	59	47	3	3	2.5	2.5	355	530	2200	3200
	150	30.5	29	20	3	3	2.5	2.5	165	202	2200	3200
	160	40	37	31	3	3	2.5	2.5	259	285	2200	3200
	160	40	37	31	3	3	2.5	2.5	224	256	2200	3200
	160	40	37	26	3	3	2.5	2.5	239	245	2200	3200
	160	40	37	26	3	3	2.5	2.5	229	276	2300	3500
	160	40	37	26	3	3	2.5	2.5	226	270	2300	3500
	160	58	55	45	3	3	2.5	2.5	345	455	2000	3000
	160	58	55	45	3	3	2.5	2.5	330	450	2000	3000

Designations	Abutment and fillet dimensions							Calculation coefficient				Weight	
	d _a max	d _b min	D _a min	D _a max	D _b min	C _a min	C _b min	e	Y	Y ₀	a		
													kg
30614-1	85	80	121	155	156	4	6.3	0.7	0.86	0.47	52	6.09	
31314X3A/P6XYA6	85	82	118	138	141	5	13	0.7	0.86	0.47	51	5.71	
33015	84	82	104	108	110	6	5.5	0.3	2	1.1	23	1.10	
33015X2-RS2	84	82	104	108	110	6	5.5	0.3	2	1.1	23	1.23	
32015	84	83	100	108	112	6	6	0.46	1.3	0.72	25	0.922	
33115	87	84	107	118	121	4.5	8	0.4	1.5	0.83	29	1.80	
33115/YA6	84	84	109	117	120	6	8	0.4	1.5	0.8	29	1.76	
33215	87	84	109	123	126	4.5	10	0.43	1.4	0.77	32	2.27	
30215	85	84	115	121	125	4.5	5.3	0.44	1.4	0.76	28	1.4	
32215	85	84	114	122	125	4	6	0.43	1.4	0.8	29	1.72	
32215AR/YA6	87	83	110	125	123	4.5	6.5	0.41	1.5	0.81	29	1.83	
32215A/YA6	87	83	110	125	123	4.5	6.5	0.41	1.5	0.81	29	1.74	
32215/YA6	86	87	111	121	125	6	6.3	0.44	1.4	0.76	30	1.76	
32215-ZQ	86	87	111	121	125	6	6.3	0.44	1.38	0.76	30	1.72	
32215-ZQ/P6X	86	87	111	121	125	6	6.3	0.44	1.38	0.76	30	1.72	
33215X2A	87	85	110	135	128	4.5	9.5	0.4	1.5	0.82	33	2.58	
33215X2A-1	87	87	110	126	128	4.5	9	0.4	1.5	0.82	33	2.66	
30615A	85	83	113	127	128	5	9	0.4	1.49	0.82	34	2.66	
32315X3A	98	87	132	171	168	6	18.7	0.35	1.74	0.96	38	4.81	
31315X3	93	85	126	146	142	5	13	0.64	0.94	0.52	38	2.24	
30315	95	87	139	148	150	4.5	9	0.35	1.7	0.96	32	3.71	
30315/YAD	96	87	139	148	149	5	9	0.35	1.7	0.9	31	3.61	
31315	86	87	127	148	153	6	14	0.83	0.7	0.4	50	3.40	
31315/YB2	93	85	126	146	142	5	13	0.83	0.73	0.4	50	3.4	
31315/YB4	94	88	131	151	150	4.5	13	0.83	0.7	0.4	41	3.4	
32315	94	87	131	151	150	4.5	13	0.35	1.7	0.96	38	5.35	
32315B	94	87	131	151	150	4.5	13	0.55	1.1	0.6	47	5.46	

Single-row Tapered Roller Bearing(Metric)

d 75-80 mm

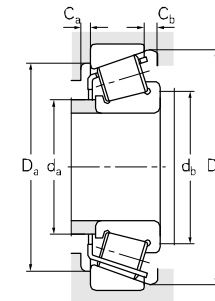
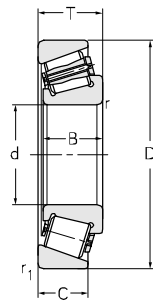
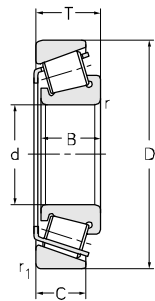

Principal dimensions					Basic load ratings				Limit speed ratings			
d	D	T	B	C	r _{radial}	r _{axial}	r _{1radial}	r _{1axial}	C _r	C _{0r}	Grease	Oil
											r/min	
75	180	63.65	60	45	3	3	2.5	2.5	375	490	2000	3000
	180	63.5	60	45	4	4	3	3	370	480	2000	3000
76	141	28.25	26	22	0.5	0.5	2	2	165	209	2300	2800
80	110	20	20	16	1	1	1	1	71	119	2700	3700
	110	20	19	16	1	1	1	1	63	105	2700	3700
	125	29	29	22	1.5	1.5	1.5	1.5	139	219	2600	3600
	125	36	36	29.5	1.5	1.5	1.5	1.5	172	281	2600	3600
130	37	37	29	2	2	1.5	1.5	179	280	2600	3600	
130	32	31	25	3.5	3.5	2	2	151	218	2400	3400	
140	46	46	35	2.5	2.5	2	2	264	390	2200	3200	
140	45	45	36.5	3	3	2.5	2.5	230	380	2200	3200	
140	28.25	26	22	2.5	2.5	2	2	149	183	2400	3400	
140	29	29	22	0.3	0.3	2	2	156	204	2400	3400	
140	35.25	33	28	2.5	2.5	2	2	198	263	2400	3400	
140	35.5	33	28	2.3	2.3	2.3	2.3	162	216	2400	3400	
140	39.2	39.2	32	2.5	2.5	2	2	205	360	2400	3400	
140	35.25	33	28	5.5	5.5	2	2	198	263	2400	3400	
140	35.25	33	28	3	3	2.5	2.5	180	263	2400	3400	
140	35.25	33	28	4.5	4.5	2	2	198	263	2400	3400	
140	35.25	33	28	2.5	2.5	2	2	214	290	2400	3400	
150	42	38	33	3	3	0.3	0.3	226	320	2200	2700	
165	59	59	39	3	3	4	4	300	450	2200	3200	
165	57	57	43	4	4	3	3	330	500	2200	3200	
170	61.5	58	48	3	3	2.5	2.5	390	510	1900	2800	
170	42.5	39	33	3	3	2.5	2.5	273	320	2000	3000	
170	42.5	39	27	3	3	2.5	2.5	223	260	2200	3200	
170	42.5	39	27	3	3	2.5	2.5	236	280	2200	3200	
180	63.65	60	45	3	3	2.5	2.5	370	550	1800	2800	

Designations	Abutment and fillet dimensions						Calculation coefficient				Weight	
	da _{max}	db _{min}	Da _{min}	Da _{max}	Db _{min}	Ca _{min}	Cb _{min}	e	Y	Y0		a
mm												
32315X3	98	87	132	171	168	6	18.7	0.7	0.86	0.47	57	7.90
32315X3-1	98	87	132	171	168	6	18.7	0.7	0.86	0.47	55	7.89
306/76	91	79	122	134	135	4.5	6.25	0.42	1.43	0.79	28	1.83
32916	86	88	100	106	106	5	6	0.35	1.7	0.96	38	0.548
32916X2A	86	88	100	106	106	5	6	0.32	1.83	1	20	0.500
32016	90	88	109	118	121	6	7	0.42	1.4	0.78	27	1.26
33016	90	87	112	117	119	6	6.5	0.28	2.1	1.1	26	1.62
33116	91	81	111	123	127	4.5	8	0.42	1.4	0.79	31	2.79
33116X2A	91	81	113	122	125	4.5	7	0.38	1.6	0.88	27	1.60
33216	90	90	117	132	136	4.5	11	0.43	1.4	0.78	35	2.89
33216X2A	90	90	117	132	136	4.5	11	0.28	2.16	1.19	30	2.77
30216	90	90	124	130	133	4.5	6.3	0.42	1.4	0.79	29	1.56
30216X2/YA6	90	90	124	130	133	4.5	6.3	0.42	1.43	0.79	29	1.77
32216	89	90	122	130	135	5	7.3	0.42	1.4	0.79	32	2.19
32216A/YA6	94	90	119	140	132	4.5	7.5	0.4	1.5	0.82	31	2.13
32216X2A	94	90	119	140	132	4.5	7.5	0.41	1.47	0.81	33	2.71
32216/YA6-1	91	81	120	132	134	6	7.3	0.42	1.4	0.79	32	2.19
32216/YA6-2	91	81	120	132	134	6	7.3	0.42	1.43	0.79	31	2.12
32216/YA6-3	94	90	119	140	132	4.5	7.5	0.4	1.5	0.82	31	2.13
32216/YB2	94	90	119	140	132	4.5	7.5	0.42	1.43	0.79	31	2.13
33216X3AN/YB2	90	90	117	132	136	4.5	11	0.39	1.55	0.85	35	3.17
32316X3-1	92	91	134	158	161	6	16	0.83	0.7	0.4	53	5.69
32316X3-2-ZQ/P6X	92	91	134	158	161	6	16	0.7	0.86	0.47	53	5.8
32316	97	92	142	158	160	4.5	14	0.35	1.7	0.96	41	6.43
30316	102	92	146	158	160	5	9.5	0.35	1.7	0.96	34	4.32
31316	92	91	128	156	156	6	16	0.83	0.7	0.4	53	3.65
31316/YB2	92	91	128	156	156	6	16	0.83	0.73	0.4	53	4.07
32316X3	97	92	142	158	160	4.5	14	0.76	0.86	0.47	57	7.91

Single-row Tapered Roller Bearing(Metric)

d 85-90 mm

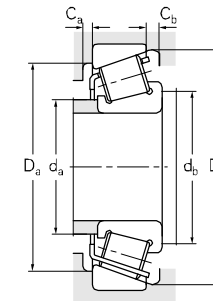
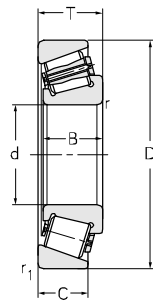
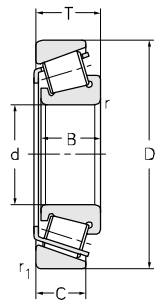

Principal dimensions					Basic load ratings				Limit speed ratings			
d	D	T	B	C	r _{radial}	r _{axial}	r _{1radial}	r _{1axial}	C _r	C _{0r}	Grease	Oil
											r/min	
85	120	23	23	18	1.5	1.5	1.5	1.5	100	172	2700	3300
	130	36	36	29.5	1.5	1.5	1.5	1.5	195	330	2600	3600
	130	29	29	22	1.5	1.5	1.5	1.5	138	220	2400	3400
	140	41	41	32	2.5	2.5	2	2	215	354	2400	3400
	150	49	49	37	2.5	2.5	2	2	286	236	2000	3000
	150	49	49	37	7	7	2	2	287	410	2000	3000
	150	30.5	28	24	2.5	2.5	2	2	175	220	2400	3400
	150	38.5	36	30	2.5	2.5	2	2	230	315	2200	3200
	150	38.5	36	30	2.5	2.5	2	2	230	315	2200	3200
	150	38.5	36	30	2.5	2.5	2	2	232	315	2200	3200
	180	63.5	60	49	4	4	3	3	425	560	1800	2600
	180	44.5	41	34	4	4	3	3	301	365	1900	2800
180	44.5	41	28	4	4	3	3	254	300	2000	3000	
90	140	32	32	24	2	2	1.5	1.5	165	255	2200	3200
	140	39	39	32.5	2	2	1.5	1.5	226	370	2200	3200
	140	32.4	30	26	2	2	1.5	1.5	150	196	2200	3200
	145	35	32	27	6.5	6.5	1.5	1.5	198	305	2200	3200
	150	45	45	35	2.5	2.5	2	2	250	390	2000	3000
	150	38.5	36	30	2.5	2.5	2	2	209	310	2000	3000
	150	45	45	35	2.5	2.5	2	2	250	390	2000	3000
	160	55	55	42	2.5	2.5	2	2	330	495	2000	3000
	160	50	46	39	3	3	3	3	235	320	2000	3000
	160	42.5	40	34	2.5	2.5	2	2	274	280	2000	3000
	160	42.5	40	34	2.3	2.3	2.3	2.3	274	280	2000	3000
	160	42.5	40	34	2.3	2.3	2.3	2.3	274	280	2000	3000
160	42.5	40	34	2.5	2.5	2	2	274	280	2000	3000	
160	32.5	30	26	2.5	2.5	2	2	222	291	2000	3000	
160	32.5	30	26	5	5	3	3	222	291	2000	3000	
170	62	59.5	49	2.5	2.5	2.5	2.5	360	520	2000	3000	

Designations	Abutment and fillet dimensions						Calculation coefficient			Weight		
	d _a max	d _b min	D _a min	D _a max	D _b min	C _a min	C _b min	e	Y		Y ₀	a
											mm	kg
32917	92	90		115	117	2	5	0.33	1.83	1.01	21	0.776
33017	94	92		122	125	6	6.5	0.3	2	1.1	26	1.70
32017	94	93		123	126	7	7	0.44	1.4	0.75	28	1.33
33117	95	95		130	135	7	9	0.4	1.5	0.8	32	2.43
33217	96	95		142	145	4.5	12	0.42	1.4	0.79	37	3.64
33217/YA6	96	95		142	145	4.5	12	0.42	1.4	0.79	37	3.64
30217	96	95		140	142	5	6.5	0.42	1.4	0.79	31	2.05
32217	95	95		140	143	5	8.5	0.42	1.4	0.79	34	2.70
32217-SG	95	95		140	143	5	8.5	0.42	1.4	0.79	34	2.7
32217/YA5	97	95		140	142	5	8.5	0.43	1.4	0.8	33	2.79
32317	102	99		166	168	4.5	15	0.35	1.7	0.96	42	7.37
30317	107	99		166	168	6	11	0.35	1.7	0.96	35	5.39
31317	96	99		166	171	6	17	0.83	0.7	0.4	56	4.92
32018	100	99		133	135	7	8	0.42	1.4	0.78	30	1.77
33018	100	99		132	135	7	6.5	0.27	2.2	1.3	27	2.24
32018X2A	100	99		131	134	6	8	0.34	1.8	0.97	23	1.71
32018X3/YA6	100	99		133	135	7	6.5	0.42	1.4	0.78	30	2.08
33118	104	100		142	145	4.5	10	0.4	1.5	0.83	35	3.22
33118X2(TRA181504)	103	10		142	145	4.5	8.5	0.42	1.4	0.79	34	2.57
33118/YB2	104	100		142	145	4.5	10	0.4	1.5	0.83	35	3.22
33218	95	99		160	126	7	13	0.29	2.1	1.13	33	4.77
33218X2A	103	102		149	149	4.5	11	0.34	1.8	0.97	35	3.82
32218	101	100		150	152	5	8.5	0.42	1.4	0.79	37	3.61
32218R/YA6	106	100		160	151	4.5	9	0.39	1.6	0.85	35	3.47
32218/YA6	106	100		160	151	4.5	9	0.39	1.6	0.85	35	3.36
32218/YB2-1	106	100		160	151	4.5	9	0.42	1.43	0.79	37	3.48
30218	102	100		150	151	5	6.5	0.42	1.4	0.79	33	2.73
30218/YA6	102	100		150	151	5	6.5	0.42	1.4	0.79	33	2.73
30618	107	100		161	161	4.5	13	0.36	1.7	0.92	42	6.04

Single-row Tapered Roller Bearing(Metric)

d 90-100 mm

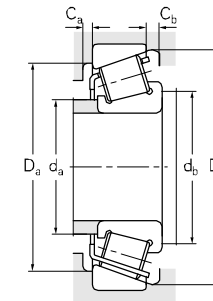
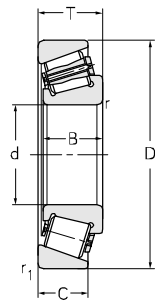
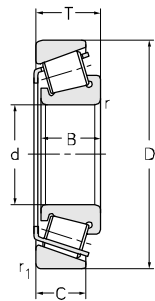

Principal dimensions					Basic load ratings				Limit speed ratings			
d	D	T	B	C	r _{radial}	r _{axial}	r _{1radial}	r _{1axial}	C _R	C _{OR}	Grease	Oil
											r/min	
90	190	46.5	43	36	4	4	3	3	335	410	1800	2600
	190	46.5	43	30	4	4	3	3	283	340	2000	3000
	190	67.5	64	53	4	4	3	3	485	650	1700	2400
90.5	160	42.5	40	34	2.5	2.5	2	2	274	380	2000	3000
95	130	23	22	18	1.5	1.5	1.5	1.5	79.5	135	2300	3300
	145	32	32	24	2	2	1.5	1.5	182	292	2200	3200
	145	32.4	30	26	2	2	1.5	1.5	161	248	2200	3200
	145	39	39	32.5	2	2	1.5	1.5	220	368	2200	3200
	145	39	39	32.5	2	2	1.5	1.5	220	368	2200	3200
	145	39	40	32.5	2	2	1.5	1.5	220	368	2200	3200
	160	47	47	38	3	3	3	3	286	460	2200	3200
	170	45.5	43	37	3	3	2.5	2.5	298	415	1900	2800
	170	45.5	43	37	3	3	2.5	2.5	300	415	1900	2800
	170	34.5	32	27	3	3	2.5	2.5	233	300	1900	2800
170	47	47	37	3	3	3	3	300	460	1900	2800	
170	58	58	44	3	3	2.5	2.5	405	560	1900	2800	
200	49.5	45	38	4	4	3	3	365	445	1800	2600	
200	49.5	45	32	4	4	3	3	305	370	1900	2800	
200	71.5	67	55	4	4	3	3	520	705	1700	2400	
200	71.5	67	55	12	12	3	3	555	765	1700	2400	
100	140	25	25	20	1.5	1.5	1.5	1.5	116	204	2400	3100
	150	32	32	24	2	2	1.5	1.5	190	281	1600	2200
	165	52	52	40	2.5	2.5	2	2	301	510	2200	2800
	180	63	63	48	3	3	2.5	2.5	430	655	1700	2400
	180	63	63	48	3	3	2.5	2.5	450	690	1700	2400
	180	37	34	29	3	3	2.5	2.5	262	340	1900	2800
	180	49	46	39	3	3	2.5	2.5	345	490	1800	2600
	215	77.5	73	60	4	4	3	3	570	780	1600	2200
	215	51.5	47	39	4	4	3	3	405	495	1700	2400
	215	56.5	51	35	4	4	3	3	430	465	1600	2200

Designations	Abutment and fillet dimensions							Calculation coefficient				Weight kg
	da _{max}	db _{min}	Da _{min}	Da _{max}	Db _{min}	Ca _{min}	Cb _{min}	e	Y	Y0	a	
mm												
30318	113	104	165	176	178	6	11	0.35	1.7	0.96	37	5.76
31318	102	104	151	176	181	6	17	0.83	0.7	0.4	59	5.53
32318	107	104	157	176	178	8	15	0.35	1.7	0.96	45	8.97
32218/YB2	101	97	136	153	155	3	8.5	0.42	1.43	0.79	37	3.48
32919X2A	102	103	117	124	126	5	7	0.38	1.59	0.87	25	0.786
32019	105	104	130	138	139	6	8	0.44	1.35	0.8	31	1.87
32019X2A	105	104	130	136	140	6	8	0.36	1.7	0.93	33	1.80
33019	105	104	128	138	140	4.5	6.5	0.28	2.2	1.19	29	2.32
33019-HD	105	104	128	138	140	4.5	6.5	0.28	2.2	1.19	29	2.32
33019X2/YB2	105	104	128	138	140	4.5	6.5	0.28	2.2	1.19	29	2.25
30619	108	107	137	149	153	4.5	9	0.34	1.8	0.97	35	3.79
32219	106	107	145	158	163	5	8.5	0.42	1.4	0.79	40	4.34
32219N1-WTL	106	107	145	158	163	5	8.5	0.42	1.4	0.79	40	4.18
30219	108	107	149	158	160	5	7.5	0.42	1.4	0.79	35	3.27
33020X3A/HA	116	107	146	159	160	7	10	0.29	2.1	1.15	33	4.26
33219	109	107	141	161	164	7	14	0.41	1.5	0.81	43	5.54
30319	118	109	172	186	185	6	12	0.35	1.7	0.96	39	6.91
31319	107	109	157	186	189	6	18	0.83	0.7	0.4	62	6.84
32319	114	109	166	186	187	8	17	0.35	1.7	0.96	47	10.0
32319/YA6	114	109	166	186	187	8	17	0.35	1.7	0.96	47	10
32920	108	105	127	134	137	3	5	0.33	1.82	1	25	1.13
30220	110	109	131	143	145	4.5	8	0.46	1.3	0.72	33	1.87
33120	111	107	140	158	160	10	12	0.41	1.48	0.81	40	4.33
33220	112	112	151	168	172	10	15	0.4	1.5	0.8	43	6.58
33220/P6XYA8	112	112	151	168	172	10	15	0.4	1.5	0.8	43	6.73
30220	114	112	157	168	169	5	8	0.42	1.4	0.79	37	3.56
32220	113	112	154	168	172	5	10	0.42	1.4	0.79	42	5.31
32320	123	115	177	201	200	8	17.5	0.35	1.7	0.9	51	13.1
30320	127	114	184	201	199	6	13	0.35	1.7	0.96	41	8.09
31320	121	115	168	201	202	7	21.5	0.83	0.72	0.4	65	8.78

Single-row Tapered Roller Bearing(Metric)

d 105~110 mm

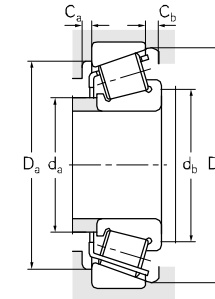
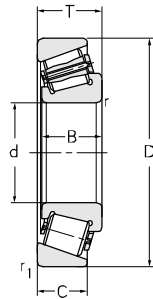
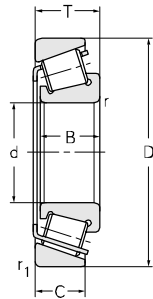

Principal dimensions					Basic load ratings				Limit speed ratings			
d	D	T	B	C	r _{radial}	r _{axial}	r _{1radial}	r _{1axial}	C _R	C _{OR}	Grease	Oil
mm											kN	r/min
105	160	35	35	26	2.5	2.5	2	2	199	320	1900	2800
	160	35	35	26	2.5	2.5	2	2	206	340	1900	2800
	160	35.4	33	28	2.5	2.5	2	2	199	320	1900	2800
	160	43	43	34	2.5	2.5	2	2	266	405	1900	2800
	160	43	43	34	5	5	2	2	266	405	1900	2800
	160	43	43	34	8	8	2	2	266	405	1900	2800
	160	43	43	34	8	8	2	2	254	430	1900	2800
	170	56	56	44	3	3	2.5	2.5	375	605	1700	2200
	170	38	38	29	2.5	2.5	2	2	246	405	1700	2200
	190	39	36	30	3	3	2.5	2.5	292	365	1800	2600
190	68	68	52	3	3	2.5	2.5	475	730	1800	2600	
190	53	50	43	3	3	2.5	2.5	375	605	1800	2600	
215	78	73	60	3	3	3	3	550	755	1900	2800	
225	53.5	49	41	4	4	3	3	430	530	1600	2200	
225	81.5	77	63	4	4	3	3	660	915	1500	2000	
106	160	35	35	26	6.4	6.4	2	2	206	340	1900	2800
	160	35	35	26	6.4	6.4	2	2	206	340	1900	2800
	160	35	35	26	8.5	8.5	3	3	200	324	1900	2800
110	150	25.4	24	20	1.5	1.5	1.5	1.5	120	224	2000	3000
	170	47	47	37	2.5	2.5	2	2	300	465	1800	2600
	170	47	47	37	2.5	2.5	2	2	305	545	1800	2600
	170	52	52	42	2.5	2.5	2	2	310	570	1800	2600
	170	38	38	29	2.5	2.5	2	2	228	365	1800	2600
	170	38.4	36	31	2.5	2.5	2	2	198	297	1800	2600
	170	38	38	29	2.3	2.3	2.3	2.3	228	365	1800	2600
	170	38	38	29	2.5	2.5	2	2	228	365	1800	2600
	180	56	56	43	2.5	2.5	2	2	364	630	1800	2600
	190	49	49	39	3	3	3	3	360	560	1800	2600
	200	56	53	46	3	3	2.5	2.5	465	695	1700	2400
	200	56	53	46	3	3	2.5	2.5	415	600	1400	1900
	200	41	38	32	3	3	2.5	2.5	320	430	1700	2400

Designations	Abutment and fillet dimensions						Calculation coefficient			Weight		
	da _{max}	db _{min}	Da _{min}	Da _{max}	Db _{min}	Ca _{min}	Cb _{min}	e	Y		Y0	a
mm											kg	
32021	116	116	143	150	154	6	9	0.44	1.35	0.8	34	2.38
32021-HD	116	116	143	150	154	6	9	0.44	1.35	0.74	34	2.38
32021X2A	116	116	143	150	154	6	9	0.36	1.69	0.93	32	2.5
33021	117	115	141	152	154	4.5	9	0.28	2.1	1.17	31	2.98
33021/YA6	117	121	141	152	154	7	9	0.28	2.1	1.17	31	2.98
33021/YA6-1	117	125	141	152	154	7	9	0.28	2.1	1.17	31	2.98
33021/YA6-1-HD	117	125	141	152	154	7	9	0.28	2.1	1.17	31	2.92
30621	125	122	148	162	164	4.5	9	0.43	1.4	0.77	37	4.71
32021X3	125	122	148	162	164	4.5	9	0.43	1.4	0.77	37	3.36
30221	125	117	162	181	177	6	9	0.42	1.4	0.79	39	4.47
33221	129	117	165	194	188	4.5	18	0.35	1.9	1.05	49	8.02
32221	120	117	161	178	180	6	10	0.43	1.4	0.8	44	6.26
32321X3	129	117	175	204	198	4.5	18	0.31	1.9	1.05	49	12.3
30321	133	119	193	211	208	7	13	0.35	1.7	0.96	43	9.38
32321	128	119	185	211	210	8	19	0.35	1.7	0.96	54	15.0
320/106/P6X	116	116	143	150	154	6	9	0.44	1.35	0.8	34	2.32
320/106/P6XYA6	116	116	143	150	154	6	9	0.44	1.35	0.8	34	2.35
320/106/YAB	116	116	143	150	154	6	9	0.44	1.35	0.74	35	2.38
32922X2A	120	118	138	143	145	7	5.4	0.28	2.1	1.117	23	1.18
33022	123	120	148	162	162	4.5	10	0.29	2.1	1.15	33	3.75
33022/P6XYA8	123	120	148	162	162	4.5	10	0.29	2.1	1.15	33	3.85
33022X2	123	120	148	162	162	4.5	10	0.29	2.1	1.15	33	4.27
32022	123	121	152	160	163	7	9	0.43	1.4	0.8	36	3.03
32022X2A	122	120	152	160	163	7	9	0.35	1.7	0.95	33	3.10
32022/YA6	123	121	152	160	163	7	9	0.43	1.4	0.8	36	3.08
32022/YA8	123	120	148	162	164	4.5	9	0.43	1.4	0.77	37	3.11
33122	121	121	155	170	174	9	13	0.43	1.4	0.8	44	5.50
33022X3A/HA	125	120	151	172	175	7	13	0.42	1.4	0.79	44	5.87
32222	124	122	170	188	192	6	10	0.42	1.4	0.79	48	7.62
32222/YA8	129	122	167	191	190	4.5	10	0.42	1.4	0.79	48	7.58
30222	132	122	171	191	187	6	9	0.42	1.4	0.79	41	5.27

Single-row Tapered Roller Bearing(Metric)

d 110~130 mm

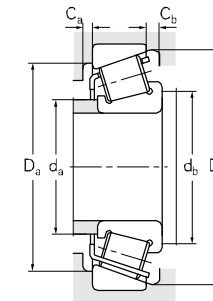
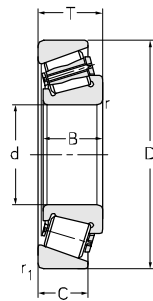
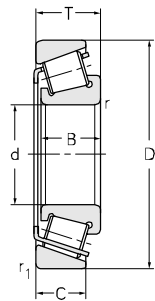

Principal dimensions					Basic load ratings				Limit speed ratings			
d	D	T	B	C	r _{radial}	r _{axial}	r _{1radial}	r _{1axial}	C _R	C _{OR}	Grease	Oil
										r/min		
110	240	54.5	50	42	4	4	3	3	470	580	1600	2200
	240	63	57	38	4	4	3	3	470	595	1600	2200
	240	84.5	80	65	4	4	3	3	670	1030	1400	1900
115	190	49	49	35	2.5	2.5	2.5	2.5	282	440	1600	2200
120	165	29	29	23	1.5	1.5	1.5	2.5	189	320	1600	2200
	180	48	48	38	2.5	2.5	2	2	295	530	1800	2600
	180	48	48	38	2.5	2.5	2	2	305	550	1800	2600
	180	38	38	29	2.5	2.5	2	2	237	395	1700	2400
	180	38	38	29	2.5	2.5	2	2	250	420	1700	2400
	180	38.4	36	31	2.5	2.5	2	2	230	325	1700	2400
	180	38	38	29	2.5	2.5	2	2	250	430	1700	2400
	200	62	62	48	2.5	2.5	2	2	440	770	1700	2400
	215	61.5	58	50	3	3	2.5	2.5	480	720	1600	2200
	215	43.5	40	34	3	3	2.5	2.5	335	465	1600	2200
	260	59.5	55	46	4	4	3	3	560	710	1500	2000
	260	68	62	42	4	4	3	3	531	690	1200	1700
	260	90.5	86	69	4	4	3	3	860	1330	1300	1800
130	180	32.5	30	26	2	2	1.5	1.5	178	350	1700	2400
	200	55	55	43	2.5	2.5	2	2	385	690	1500	2000
	200	45	45	34	2.5	2.5	2	2	340	580	1600	2200
	200	45.5	42	36	2.5	2.5	2	2	271	420	1500	2000
	230	43.75	40	34	4	4	3	3	360	480	1500	2000
	230	55.75	52	42	8	8	3	3	495	750	1400	1900
	230	67.75	64	54	4	4	3	3	555	845	1500	2000
	230	67.75	64	54	4	4	3	3	555	845	1500	2000
	230	67.75	64	54	4	4	3	3	555	845	1500	2000
	280	63.75	58	49	5	5	4	4	625	800	1300	1800
	280	72	66	44	5	5	4	4	620	805	1300	1800
	280	98.75	93	78	3.7	3.7	3.7	3.7	795	1250	1100	1600

Designations	Abutment and fillet dimensions							Calculation coefficient			Weight	
	d _a max	d _b min	D _a min	D _a max	D _b min	C _a min	C _b min	e	Y	Y ₀		a
mm												
30322	142	124	206	226	222	8	13	0.35	1.7	0.96	45	11.1
31322	129	124	188	226	226	7	25	0.83	0.7	0.4	75	12.5
32322	137	125	198	226	222	9	19.5	0.35	1.7	0.9	55	17.9
30623	131	120	160	181	180	4.5	14	0.44	1.4	0.74	42	5.13
32924	131	118	150	158	161	4.5	6	0.35	1.7	0.95	29	1.79
33024A	132	131	160	170	171	6	10	0.3	2	1.1	36	4.17
33024-HD	132	131	160	170	171	6	10	0.31	1.97	1.08	36	4.07
32024	132	120	157	172	175	4.5	9	0.46	1.3	0.72	40	3.31
32024-HD	132	131	161	170	173	7	9	0.46	1.3	0.7	39	3.27
32024X2A	131	130	161	170	173	7	9	0.37	1.6	0.89	29	3.66
32024/YA5-ZQ/P6X	131	130	161	170	173	7	9	0.46	1.31	0.72	39	3.29
33124	135	132	177	190	190	6	9.5	0.44	1.4	0.76	45	7.74
32224	134	132	181	203	206	7	12	0.44	1.4	0.76	52	9.60
30224	139	132	187	203	203	6	9.5	0.44	1.4	0.76	45	6.32
30324	153	135	221	245	237	7	13.5	0.35	1.7	0.9	47	14.2
31324	145	135	203	245	244	9	26	0.83	0.72	0.4	78	15.6
32324	148	135	213	245	239	9	21.5	0.35	1.7	0.9	60	22.4
32926X2A	142	139	164	173	174	9	6.5	0.27	2.2	1.22	28	2.31
33026	144	138	175	193	194	9	12	0.34	1.76	0.97	42	6.04
32026	144	142	178	190	192	7	11	0.43	1.4	0.8	42	5.06
32026X2A	144	140	178	190	192	8	11	0.35	1.7	0.95	39	4.66
30226	150	144	203	216	219	7	10	0.44	1.4	0.76	47	7.02
30226X2	150	144	203	216	219	7	10	0.39	1.56	0.86	48	9.25
32226	143	144	193	216	221	7	14	0.44	1.4	0.76	56	11.8
32226-1	146	146	193	216	219	7	13.5	0.43	1.4	0.8	56	11.6
32226A	146	146	193	216	219	7	13.5	0.43	1.4	0.8	56	11.7
30326	164	150	239	263	255	8	14.5	0.35	1.7	0.9	51	17.4
31326	150	147	218	262	263	9	28	0.83	0.7	0.4	87	18.9
32326/YA6	168	144	227	280	258	4.5	22	0.32	1.9	1.04	65	26.4

Single-row Tapered Roller Bearing(Metric)

d 140~170 mm

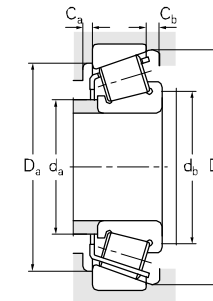
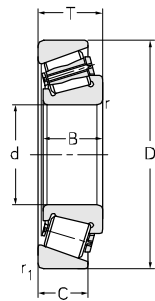
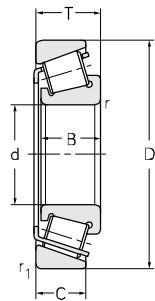

Principal dimensions					Basic load ratings				Limit speed ratings				
d	D	T	B	C	r _{radial}	r _{axial}	r _{1radial}	r _{1axial}	C _r	C _{Or}	Grease	Oil	
										r/min			
140	190	32	32	25	2	2	1.5	1.5	206	390	1600	2200	
	190	32.5	30	26	2	2	1.5	1.5	206	390	1600	2200	
	210	45	45	34	2.5	2.5	2	2	330	560	1600	2200	
	210	45.5	42	36	2.5	2.5	2	2	330	560	1600	2200	
	230	58	57	45	3	3	3	3	400	660	1600	2200	
	230	58	57	45	3	3	3	3	400	660	1600	2200	
	250	45.75	42	36	4	4	3	3	405	540	1400	1900	
	250	71.75	68	58	4	4	3	3	650	1000	1400	1900	
	300	107.75	102	85	5	5	4	4	1090	1630	1200	1700	
	300	67.75	62	53	5	5	4	4	740	945	1200	1700	
	300	77	70	47	5	5	4	4	695	900	1200	1700	
	300	90	82	60	3.7	3.7	3.7	3.7	660	915	1200	1700	
150	210	38	38	30	2.5	2.5	2	2	270	465	1500	2000	
	210	38.5	36	31	2.5	2.5	2	2	220	385	1500	2000	
	225	48	48	36	3	3	2.5	2.5	365	635	950	1400	
	225	48.5	45	38	3	3	2.5	2.5	365	635	950	1400	
	225	48.5	45	38	3	3	2.5	2.5	254	635	950	1400	
	270	49	45	38	4	4	3	3	450	605	1300	1800	
	270	77	73	60	4	4	3	3	735	1140	1200	1700	
	320	114	108	90	5	5	4	4	1280	1880	950	1400	
	320	72	65	55	5	5	4	4	815	1050	1100	1600	
	160	220	38.5	36	31	2.5	2.5	2	2	232	400	1500	2000
		240	51	51	38	3	3	2.5	2.5	415	730	1100	1600
		240	51.5	48	41	3	3	2.5	2.5	415	730	1100	1600
290		52	48	40	4	4	3	3	510	695	1100	1600	
290	84	80	67	4	4	3	3	925	1490	1100	1600		
340	88	79	54	3.7	3.7	3.7	3.7	825	1080	1000	1500		
340	121	114	95	5	5	4	4	1540	2230	1000	1500		
170	220	27	25	19.5	3	3	3	3	166	328	1600	2150	

Designations	Abutment and fillet dimensions							Calculation coefficient				Weight kg
	da _{max}	db _{min}	Da _{min}	Da _{max}	Db _{min}	Ca _{min}	Cb _{min}	e	Y	Y0	a	
mm												
32928	150	150	177	182	184	6	7	0.35	1.7	0.9	33	2.55
32928X2A	142	149	164	183	174	9	6.5	0.27	2.2	0.22	28	2.43
32028	154	150	183	202	204	4.5	11	0.46	1.3	0.72	46	5.84
32028X2A	153	150	187	201	202	8	11	0.37	1.6	0.89	42	4.94
30628	182	152	217	219	242	4.5	13	0.44	1.4	0.74	56	8.97
30628R	182	152	217	219	242	4.5	13	0.44	1.4	0.74	56	9.2
30228	162	154	219	236	234	9	11	0.44	1.4	0.76	50	8.8
32228	156	154	210	236	240	8	14	0.44	1.4	0.76	61	14.7
32328	177	156	239	287	276	9	22.8	0.37	1.6	0.9	74	35.8
30328	176	155	255	282	275	9	15	0.35	1.7	0.96	56	21.2
31328	162	157	235	282	283	9	30	0.83	0.7	0.4	93	23.4
31328X2A	176	154	228	300	276	4.5	30	0.73	0.8	0.45	91	29.0
32930	161	160	190	202	202	9	7.5	0.33	1.83	1	36	3.83
32930X2A	165	160	191	202	201	9	7.5	0.27	2.2	1.21	33	4.56
32030	161	160	197	216	217	9	13	0.46	1.3	0.72	49	6.40
32030X2	164	162	200	213	216	8	13	0.39	1.5	0.85	46	6.84
32030X2A	164	162	200	213	216	8	13	0.39	1.54	0.85	46	6.84
30230	174	164	234	256	252	9	11	0.44	1.4	0.76	53	11.2
32230	168	164	223	256	256	4.5	17	0.44	1.4	0.76	64	18.4
32330	190	166	261	307	299	4.5	24	0.35	1.7	0.96	77	42.2
30330	190	165	273	302	294	4.5	17	0.35	1.7	0.96	60	25.5
32932X2A	175	170	203	212	213	9	7.5	0.27	2.2	1.23	34	3.79
32032	174	173	211	231	232	8	13	0.46	1.3	0.72	53	7.69
32032X2A-1	175	172	213	228	231	8	13	0.37	1.6	0.89	47	7.67
30232	189	174	252	276	271	9	12	0.44	1.4	0.76	57	13.4
32232	180	174	242	276	276	10	17	0.44	1.4	0.76	70	23.3
31332	199	161	265	340	315	4.5	34	0.76	0.8	0.43	100	29.9
32332	199	176	274	327	314	4.5	26	0.35	1.7	0.96	81	51.7
32934X3	175	171	203	211	212	9	7.5	0.47	1.3	0.72	53	2.33

Single-row Tapered Roller Bearing(Metric)

d 170~190 mm

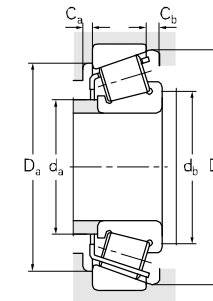
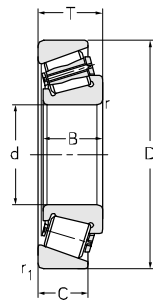
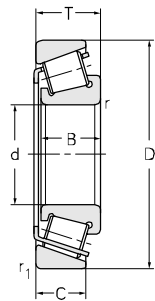

Principal dimensions					Basic load ratings				Limit speed ratings			
d	D	T	B	C	r _{radial}	r _{axial}	r _{1radial}	r _{1axial}	C _R	C _{OR}	Grease	Oil
										r/min		
170	230	38	38	30	2.5	2.5	2	2	280	560	1400	1900
	230	38.5	36	31	2.5	2.5	2	2	235	415	1400	1900
	260	57	57	43	3	3	2.5	2.5	520	870	1200	1700
	260	57	57	43	1.5	1.5	1.5	1.5	520	870	1600	2100
	260	57.5	54	46	3	3	2.5	2.5	430	750	1400	1900
	310	91	86	71	5	5	4	4	1010	1630	1000	1500
	360	80	72	62	5	5	4	4	945	1360	950	1400
	360	128	120	100	3.7	3.7	3.7	3.7	1430	2120	950	1400
	360	127	120	100	5	5	5	5	1440	2140	950	1400
	180	250	45	45	34	2.5	2.5	2	2	345	725	1600
250		45	42	36	2.5	2.5	2	2	345	725	1200	1700
280		64	64	48	3	3	2.5	2.5	610	1070	950	1400
280		64.5	60	52	3	3	2.5	2.5	610	1070	950	1400
280		64.5	60	52	3	3	2.5	2.5	610	1070	950	1400
290		65	63.5	48	2.3	2.3	2.3	2.3	580	1010	950	1400
300		73	70	60	3	3	3	3	730	1210	950	1400
320		57	52	43	5	5	4	4	590	820	1000	1500
320		91	86	71	5	5	4	4	940	1700	950	1400
380		83	75	64	5	5	4	4	1180	1580	900	1300
380	98	88	60	5	5	4	4	1050	1500	900	1300	
190	260	45	45	34	2.5	2.5	2	2	350	670	1100	1600
	260	45.5	42	36	2.5	2.5	2	2	350	670	1100	1600
	290	64	64	48	3	3	2.5	2.5	650	1180	1000	1500
	290	64.5	60	52	3	3	2.5	2.5	650	1180	1000	1500
	290	51	46	40	3	3	2.5	2.5	380	610	950	1400
	290	64.5	60	52	3	3	2.5	2.5	650	1180	1000	1500
	290	64.5	60	52	3	3	2.5	2.5	650	1180	1000	1500
	340	60	55	46	5	5	4	4	680	1040	950	1400
	400	103	90	62	5	5	4	4	1180	1690	810	1000

Designations	Abutment and fillet dimensions						Calculation coefficient				Weight		
	da _{max}	db _{min}	Da _{min}	Da _{max}	Db _{min}	Ca _{min}	Cb _{min}	e	Y	Y0		a	
												mm	kg
32934 32934X2A	183	182	213	220	222	7	8	0.37	1.6	0.9	42	4.51	
	185	180	213	222	224	9	7.5	0.28	2.1	1.17	36	3.864	
32034 32034/P4YA6 32034X2A 32234	188	184	230	246	249	10	14	0.44	1.35	0.8	56	10.6	
	188	184	230	246	249	10	14	0.44	1.35	0.8	56	10.6	
	187	182	230	248	249	10	14	0.31	1.9	1.07	47	10.1	
	196	190	259	293	294	10	20	0.43	1.4	0.8	75	30.0	
30334 32334/YA6 32334/YA6-1	217	185	304	348	333	10	18	0.35	1.74	0.96	68	35.8	
	213	184	288	360	332	4.5	28	0.36	1.7	0.92	87	63.5	
	213	184	288	360	332	4.5	28	0.36	1.7	0.92	87	63.5	
32936 32936X2A 32036 32036X2A 32036X2A/YA8 32036X3A	194	192	225	240	241	8	11	0.48	1.25	0.7	53	6.7	
	194	152	225	240	241	8	11	0.48	1.25	0.7	53	6.44	
	199	192	247	268	267	9	16	0.42	1.4	0.8	75	13.9	
	199	192	247	268	267	9	16	0.28	2.2	1.19	53	13.0	
	199	192	247	268	267	9	16	0.28	2.2	1.19	53	13.1	
	207	196	247	290	274	4.5	17	0.44	1.4	0.75	62	15.6	
	209	198	278	302	300	4.5	14					19.8	
30236 32236 30336 31336	209	198	278	302	300	4.5	14	0.45	1.3	0.73	64	17.8	
	204	200	267	303	303	10	20	0.44	1.35	0.8	78	30.2	
	207	233	362	324	345	10	19	0.36	1.7	0.92	72.4	41.4	
	217	220	289	368	355	12	21	0.55	0.73	0.8	120	46.4	
	205	202	235	252	251	10	9.5	0.48	1.25	0.7	55	6.94	
32938 32938X2A	205	202	235	252	251	10	9.5	0.38	1.6	0.86	49	6.52	
	210	204	257	276	279	10	16	0.44	1.35	0.8	62	14.5	
32038 32038X2A 32038X2A-1 32038X2A/P4 32038X2A/YA8	209	202	257	278	279	10	13	0.37	1.6	0.89	58	15.28	
	215	202	256	281	272	4.5	11	0.38	1.6	0.87	53	10.5	
	209	202	257	278	279	10	13	0.37	1.6	0.89	58	15.3	
	209	202	257	278	279	10	13	0.37	1.6	0.89	58	15.28	
	224	210	298	323	318	9	14	0.43	1.8	0.8	63	20.6	
30238 31338	234	203	306	388	375	13	41	0.83	0.72	0.4	126	53.3	

Single-row Tapered Roller Bearing(Metric)

d 200~240 mm

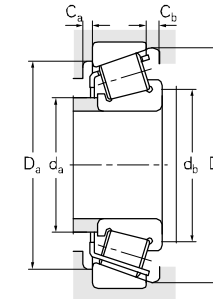
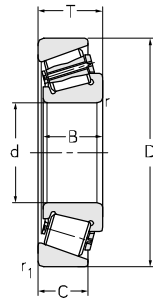
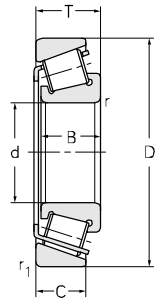

Principal dimensions					Basic load ratings				Limit speed ratings			
d	D	T	B	C	r _{radial}	r _{axial}	r _{1radial}	r _{1axial}	C _R	C _{OR}	Grease	Oil
											r/min	
200	280	51	51	39	3	3	2.5	2.5	455	935	1000	1500
	280	51.5	48	41	3	3	2.5	2.5	455	935	1000	1500
	310	70	70	53	3	3	2.5	2.5	760	1370	950	1400
	310	70.5	66	56	3	3	2.5	2.5	760	1370	950	1400
	310	70	66	56	3	3	2.5	2.5	760	1370	950	1400
	310	70	66	56	3	3	2.5	2.5	760	1370	950	1400
	360	64	58	48	5	5	4	4	780	1100	900	1300
	360	104	98	82	5	5	4	4	1350	2144	900	1300
	420	146	138	115	5	5	5	5	1820	2850	800	1100
	210	285	41	40	33	4	4	3	3	360	710	1000
220	300	51	51	39	3	3	2.5	2.5	465	960	950	1400
	300	51.5	48	41	3	3	2.5	2.5	465	960	900	1400
	340	76	76	57	4	4	3	3	850	1520	900	1300
	340	76	76	57	4	4	3	3	850	1520	900	1300
	340	76.5	72	62	4	4	3	3	850	1520	950	1400
	360	85	82	70	4	4	4	4	1000	1800	830	1050
	400	72	65	54	5	5	4	4	975	1370	900	1300
	400	73	65	54	3.7	3.7	3.7	3.7	975	1370	900	1300
	400	72	65	54	5	5	4	4	993	1400	850	1200
	400	114	108	90	5	5	4	4	1650	2770	900	1300
460	154	145	122	5	5	5	5	2130	3310	710	900	
240	320	51	48	41	3	3	2.5	2.5	505	1080	900	1300
	320	51	48	41	3	3	2.5	2.5	505	1080	900	1300
	360	76	76	57	4	4	3	3	905	1660	850	1200
	360	76	76	57	4	4	3	3	905	1660	850	1200
	360	76.5	72	62	4	4	3	3	770	1400	850	1200
	440	79	72	60	5	5	4	4	1070	1550	750	1000
	440	127	120	100	5	5	4	4	1900	3300	700	950
	440	127	120	100	5	5	4	4	1900	3300	750	1000
	500	165	155	132	6	6	5	5	2360	4100	670	900

Designations	Abutment and fillet dimensions						Calculation coefficient				Weight		
	da _{max}	db _{min}	Da _{min}	Da _{max}	Db _{min}	Ca _{min}	Cb _{min}	e	Y	Y0		a	
mm													
32940	218	215	252	271	270	4.5	11	0.39	1.5	0.84	54	9.56	
	32940X2A	220	212	251	271	270	4.5	11	0.39	1.5	0.84	54	8.86
32040	222	214	273	296	297	11	17	0.43	1.4	0.8	66	19.5	
	32040X2A	221	212	273	298	297	11	17	0.39	1.5	0.84	65	18.2
	32040X2A/P4YA8	221	212	273	298	297	11	17	0.39	1.53	0.84	67	17.8
	32040X2A/YA8	221	212	273	298	297	11	17	0.39	1.5	0.84	65	17.8
30240	236	218	315	342	338	9	16	0.44	1.4	0.76	70	25.4	
	32240	222	218	302	342	11	22	0.41	1.5	0.81	84	42.6	
	32340	239	253	398	346	346	11	31	0.37	1.6	0.88	107	90.5
30642N1-WTL	218	215	252	271	270	4.5	11	0.32	1.9	1.04	52	7.28	
32944	234	234	275	286	290	9	12	0.43	1.4	0.8	58	10.0	
	32944X2A	310	232	342	291	361	10	11	0.39	1.5	0.84	66	10.1
	32044	244	234	300	325	326	12	19	0.43	1.4	0.8	72	23.9
	32044/P6-XD	244	236	300	325	326	12	19	0.43	1.4	0.8	72	24.2
	32044X2A	243	234	300	326	326	12	19	0.35	1.7	0.95	67	23.3
	32044X3	243	234	300	326	326	12	19	0.4	1.51	0.83	77	32.9
	30244	256	220	334	382	382	10	18	0.42	1.4	0.79	77	36.8
	30244A/YA6	256	220	334	382	382	10	19	0.37	1.6	0.88	71	37.6
	30244/HC	259	242	348	383	371	10	18	0.43	1.4	0.8	74	36.8
	32244	256	220	334	382	382	10	24	0.44	1.4	0.76	96	62.7
32344	274	235	372	445	430	13	32	0.37	1.62	0.89	112	114	
32948	259	252	331	387	309	10	11	0.32	1.9	1.04	52	10.8	
	32948X2A/P4	259	252	331	387	309	10	11	0.32	1.9	1.04	52	11.1
	32048	262	256	318	345	346	12	19	0.46	1.3	0.7	78	26
	32048/P6-XD	262	256	318	345	346	12	19	0.46	1.3	0.7	78	26
	32048X2A	261	254	318	346	346	12	19	0.31	1.9	1.05	65	23.8
	30248	267	288	422	384	408	11	19	0.44	1.4	0.74	85	46.8
	32248	276	262	365	420	415	14	27	0.43	1.4	0.8	105	82.5
	32248/HC	276	262	365	420	415	14	27	0.43	1.4	0.8	105	82.5
	32348	279	301	478	410	464	12	33	0.37	1.6	0.88	123	147

Single-row Tapered Roller Bearing(Metric)

d 254~300 mm

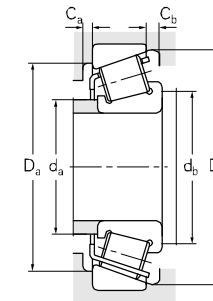
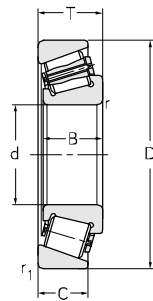
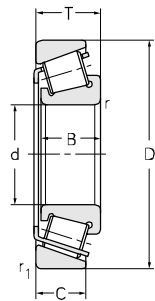

Principal dimensions					Basic load ratings				Limit speed ratings			
d	D	T	B	C	r _{radial}	r _{axial}	r _{1radial}	r _{1axial}	C _R	C _{OR}	Grease	Oil
										r/min		
254	422.275	86.1	79.8	66.7	4.7	4.7	2.5	2.5	1010	1760	710	900
255	560	123.05	104.8	70	6	6	6	6	1920	2690	560	750
260	360	63.5	63.5	48	3	3	2.5	2.5	650	1270	800	1100
	360	63.5	63.5	48	3	3	2.5	2.5	650	1270	800	1100
	360	64.5	60	52	3	3	2.5	2.5	595	1250	800	1100
	360	64.5	60	53	3	3	2.5	2.5	630	1310	800	1100
	400	87	87	65	5	5	4	4	1100	2030	800	1100
	400	87	87	65	5	5	4	4	1100	2030	800	1100
	400	87.7	82	71	5	5	4	4	1050	1960	800	1100
	480	89	80	67	6	6	5	5	1430	2150	670	900
	480	137	130	105	6	6	5	5	2160	3650	670	900
	480	133.5	141	102.5	6	6	5	5	2280	3750	670	900
	540	114	102	85	6	6	6	6	2015	2730	670	900
280	380	63.5	63.5	48	3	3	2.5	2.5	720	1500	800	1100
	380	64.5	60	52	3	3	2.5	2.5	720	1500	800	1100
	420	87	87	65	5	5	4	4	1200	2300	750	1000
	420	87	87	65	5	5	4	4	1200	2300	750	1000
	420	87.7	82	71	5	5	4	4	1200	2300	750	1000
285	370	40	40	28	3	3	2.5	2.5	360	720	730	930
300	420	74.5	72	62	4	4	3	3	710	1810	700	950
	420	76.5	72	62	4	4	3	3	880	1870	700	950
	440	73	70	55	4	4	3	3	860	1460	700	950
	460	100	100	74	5	5	4	4	1460	2740	670	900
	460	100	100	74	5	5	4	4	1430	2740	670	900
	460	100.7	95	77	5	5	4	4	1310	2400	700	950
	540	96	85	71	6	6	5	5	1600	2500	630	760
	540	149	140	115	6	6	5	5	2610	4450	670	900

Designations	Abutment and fillet dimensions						Calculation coefficient			Weight		
	d _a max	d _b min	D _a min	D _a max	D _b min	C _a min	C _b min	e	Y		Y ₀	a
mm												kg
306/254	293	270	371	413	403	12	19	0.36	1.65	0.9	81	45.4
30651	329	274	435	542	510	13	53.1	0.87	0.7	0.38	171	127
32952	286	272	325	351	344	13	13	0.41	1.48	0.81	72	17.9
32952/P4	286	272	325	351	344	13	13	0.3	2	1.09	60	17.9
32952X2A	286	272	325	351	344	13	13	0.3	2	1.09	60	19.2
32952X2A-1	286	272	325	351	344	13	13	0.3	2	1.09	60	19.1
32052	287	282	352	383	383	13	12	0.43	1.4	0.8	84	39.8
32052/HC	287	282	352	383	383	13	22	0.43	1.4	0.8	84	37.5
32052X2A	287	278	352	382	383	14	22	0.3	2	1.11	71	37.8
30252	293	316	458	421	447	12	22	0.44	1.4	0.74	94	63.9
32252	305	279	394	465	451	13	32	0.43	1.4	0.77	113	105
32252X2/HC	302	285	397	465	453	12	30	0.43	1.4	0.77	111	101
30352	332	279	449	522	481	10	29	0.32	1.9	1.04	92	113
32956	305	292	344	371	364	13	13	0.43	1.4	0.77	100	20
32956X2A	305	292	344	371	364	13	13	0.32	1.9	1.03	64	21.3
32056	305	302	370	400	402	14	22	0.46	1.3	0.7	89	40.4
32056/HC	305	302	370	400	402	14	22	0.46	1.3	0.7	89	40.4
32056X2A	305	302	370	400	402	14	22	0.46	1.3	0.7	89	39.6
306/285	308	295	344	361	358	10	12	0.4	1.49	0.82	61	10.1
32960	330	314	379	409	400	13	15	0.28	2.1	1.17	67	30.2
32960X2A	330	314	379	409	400	13	15	0.28	2.12	1.17	70	30.2
32960X3B/P5	335	314	398	429	423	13	18	0.44	1.4	0.75	87	34.2
32060	330	322	404	440	439	15	26	0.43	1.4	0.8	97	56.6
32060/HC	330	322	404	440	439	15	26	0.43	1.4	0.8	97	56.6
32060X2A	329	318	404	442	439	15	26	0.36	1.7	0.9	89	57.0
30260	358	320	458	525	498	15	25	0.44	1.36	0.75	106	84.7
32260/HCYB2								0.43	1.39	0.77	126	138

Single-row Tapered Roller Bearing(Metric)

d 320~420 mm

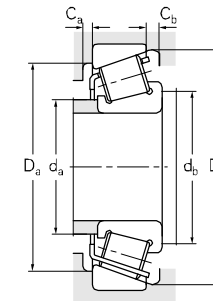
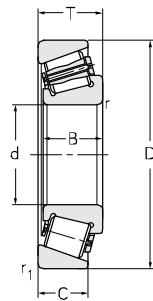
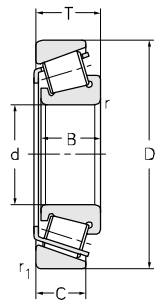

Principal dimensions					Basic load ratings				Limit speed ratings			
d	D	T	B	C	r _{radial}	r _{axial}	r _{1radial}	r _{1axial}	C _R	C _{OR}	Grease	Oil
											r/min	
320	440	76	72	62	4	4	3	3	960	1940	670	900
	480	100	100	74	5	5	4	4	1540	2940	630	850
	480	100	100	74	5	5	4	4	1550	2940	630	850
	480	95	95	70	5	5	4	4	1480	2860	630	850
	580	104	92	75	6	6	5	5	1700	2560	530	750
340	460	76	76	57	4	4	3	3	1000	2350	500	830
	460	76	76	57	4	4	3	3	1000	2350	500	830
	460	76	72	63	4	4	3	3	920	1990	500	830
	500	100	100	74	5	5	5	5	1800	3050	500	630
	500	100	100	74	5	5	5	5	1530	3050	500	630
360	520	86	82	64	5	5	4	4	1200	2050	500	630
	480	76	76	57	4	4	4	4	970	2220	500	630
	530	80	66	59	5	5	5	5	1030	1900	500	630
	540	86	82	63.5	5	5	4	4	1270	2200	480	600
	650	155	150	110	7.5	7.5	7.5	7.5	2900	5650	400	500
380	520	87	82	71	5	5	4	4	1190	2670	560	750
	620	112	106	92	5	5	5	5	2170	3800	400	500
400	500	60	57	47	4	4	3	3	460	950	400	500
	540	70	65	48	4	4	4	4	965	1930	350	450
	540	70	70	53	5	5	4	4	1040	2320	350	450
	540	87	82	71	5	5	4	4	1280	2880	380	480
420	600	125	118	100	6	6	5	5	2170	4550	400	500
	750	130	115	77	6	6	6	6	2660	4180	320	430
420	560	70	65	51	4	4	4	4	1020	2090	420	560
	560	70	65	51	4	4	4	4	1020	2090	420	560
	560	87	82	72	5	5	4	4	1170	2900	420	560
	560	70	65	51	4	4	4	4	1020	2090	420	560
	620	95	90	67	5	5	5	5	1560	2930	380	480

Designations	Abutment and fillet dimensions							Calculation coefficient			Weight	
	d _a max	d _b min	D _a min	D _a max	D _b min	C _a min	C _b min	e	Y	Y ₀		a
											kg	
32964X2A	343	337	402	424	426	13	19	0.43	1.4	0.8	84	32.1
	354	336	419	467	463	13	26	0.46	1.3	0.72	104	62.7
	354	336	419	467	463	13	26	0.46	1.3	0.72	104	62.7
	354	336	419	467	463	13	26	0.46	1.3	0.72	104	57.7
	353	381	558	503	533	14	29	0.44	1.4	0.74	114	103
32968	361	357	421	444	446	14	19	0.44	1.35	0.8	90	36.5
	361	357	421	444	446	14	19	0.44	1.35	0.8	90	31.6
	361	357	421	444	446	14	19	0.41	1.45	0.8	91	31.6
32068X3/HCYB2	371	356	442	484	481	12	26	0.4	1.49	0.82	99	62.8
	371	356	442	484	481	12	26	0.4	1.49	0.82	99	62.8
	378	367	462	507	483	13	20	0.29	2.09	1.15	78	73.9
32972	388	374	433	467	468	13	19	0.46	1.3	0.72	97	38.5
	410	376	476	515	502	13	21	0.4	1.5	0.82	95	53.2
	401	390	482	526	509	13	21	0.37	1.61	0.89	97	73.1
	410	376	476	515	502	13	21	0.6	1.01	0.55	169	219
32976	407	406	502	478	501	16	16	0.39	1.6	0.86	95	50.0
	431	396	534	604	590	12	20	0.46	1.3	0.72	126	123
30680	368	414	406	489	430	13	13	0.38	1.6	0.86	77	25.1
	450	436	500	550	530	8	8	0.42	1.5	0.9	100	39.7
	450	436	500	550	530	8	8	0.42	1.5	0.9	100	44
	450	436	500	550	530	8	8	0.4	1.4	0.8	185	54.1
32080	443	420	527	585	574	14	25	0.36	1.67	0.92	118	118
	480	470	617	730	688	15	15	0.7	0.86	0.47	189	222
31984	458	436	528	528	549	13	28	0.41	1.5	0.81	106	41.7
	458	436	528	528	549	13	28	0.41	1.5	0.81	106	41.8
	448	435	507	547	547	10	15	0.41	1.46	0.8	107	56.8
31984/P4	458	436	528	528	549	13	28	0.41	1.5	0.81	106	41.7
	470	436	552	605	586	13	28	0.41	1.5	0.8	111	88.3

Single-row Tapered Roller Bearing(Metric)

d 420~830 mm

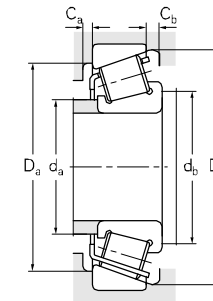
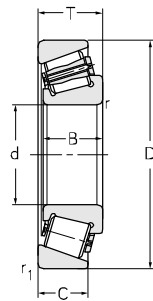
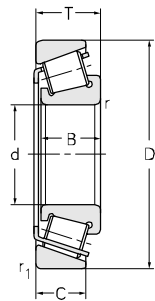

Principal dimensions					Basic load ratings				Limit speed ratings			
d	D	T	B	C	r _{radial}	r _{axial}	r _{1radial}	r _{1axial}	C _R	C _{OR}	Grease	Oil
										r/min		
420	620	95	90	67	5	5	5	5	1560	2940	380	480
	620	125	118	100	6	6	5	5	2300	5100	380	480
	700	130	122	92	6	6	6	6	2700	4990	350	440
440	620	95	90	67	5	5	5	5	1400	2900	360	460
	650	130	126	104	6	6	5	6	2620	5650	350	450
460	600	87	82	71	5	5	4	4	1340	3150	360	460
	600	87	85	63.5	4	4	4	4	1300	3010	360	460
	620	80	74	58	4	4	4	4	1260	2570	350	450
	680	105	100	78	6	6	6	6	1990	3700	330	440
470	630	80	80	62	5	5	5	5	1410	3100	350	450
530	710	88	82	62	5	5	5	5	1560	3150	340	450
600	720	73	69	56	3	3	3	3	1230	3320	340	450
	870	124	118	89	6	6	6	6	3150	6650	340	450
610	820	105	95	80	6	6	6	6	1830	4200	350	460
630	850	132	132	95	6	6	6	6	3080	7150	360	450
	920	134	128	94	7.5	7.5	7.5	7.5	3410	7100	320	430
710	950	114	106	80	6	6	6	6	2860	6900	260	360
	950	130	122	95	6	6	6	6	3400	7800	260	360
710.5	950	130	122	95	6	6	6	6	3400	7800	260	360
711	950	114	106	80	6	6	6	6	2800	6900	260	360
760	890	78	75	59	4.7	4.7	4.7	4.7	1360	3520	250	340
830	1080	156	156	118	6	6	6	6	4600	12000	230	430
	1100	156	152	118	6	6	6	6	4600	12400	230	430

Designations	Abutment and fillet dimensions							Calculation coefficient			Weight		
	da _{max}	db _{min}	Da _{min}	Da _{max}	Db _{min}	Ca _{min}	Cb _{min}	e	Y	Y0		a	
mm												kg	
31084X2/P5	470	436	552	605	586	13	28	0.41	1.5	0.8	111	88.3	
	473	444	572	572	600	13	28	0.37	1.6	0.88	120	125	
	31184X2	491	440	607	680	646	13	38	0.32	1.88	1.04	116	175
32988X3	480	455	555	605	590	10	28	0.41	1.46	0.8	114	81.3	
	32088X2	485	460	574	630	621	12	26	0.36	1.67	0.92	125	141
30692/HC	489	475	546	587	588	12	16	0.47	1.28	0.7	123	59.5	
	31992X3/HC	499	473	569	607	600	12	22	0.4	1.49	0.82	108	59.4
	31992X2	499	473	569	607	600	12	22	0.4	1.49	0.82	108	62.3
	31092X2	514	480	613	660	645	10	27					117
30694	509	485	579	615	605	10	18	0.32	1.88	1.04	94	66	
319/530X2	573	546	655	695	683	13	26	0.39	1.5	0.84	118	81.5	
306/600	624	611	679	709	706	10	17	0.37	1.64	0.9	113	53	
	310/600X2	624	611	679	709	706	10	17	0.41	1.45	0.8	155	231
306/610	662	630	741	800	781	13	25	0.37	1.6	0.88	139	139	
329/630	675	649	766	832	821	13	37	0.46	1.3	0.72	168	200	
	306/630	704	631	819	902	867	13	40	0.43	1.4	0.78	166	286
319/710	774	729	864	932	909	13	34	0.46	1.3	0.72	175	210	
	319/710X2	774	729	864	932	909	13	34	0.43	1.41	0.78	177	238
319/710.5	774	729	864	932	909	13	34	0.43	1.41	0.78	177	238	
319/711	773	731	864	932	909	13	34	0.43	1.41	0.78	61	209	
306/760/HC	785	776	393	870	870	13	22	0.32	1.9	1.04	71	78.3	
306/830/HCYB2	882	851	995	1080	1067	13	38	0.44	1.36	0.75	209	360	
	306/830/HCR	882	850	995	1080	1067	13	38	0.44	1.36	0.75	208	398

Single-row Tapered Roller Bearing(Metric)

d 831~1000 mm

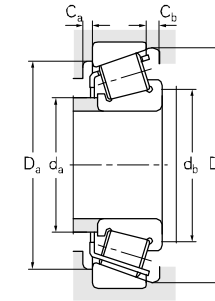
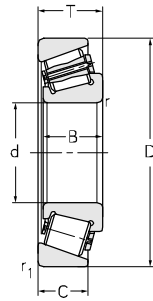
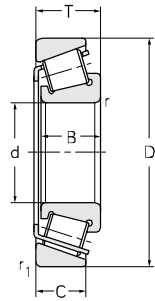

Principal dimensions					Basic load ratings				Limit speed ratings				
d	D	T	B	C	r _{radial}	r _{axial}	r _{1radial}	r _{1axial}	C _r	C _{Or}	Grease	Oil	
mm									kN	r/min			
831	1080	156	156	118	6	6	6	6	4600	12000	230	430	
	1100	156	152	118	6	6	6	6	4600	12400	230	430	
850	1030	90	88	64	6	6	6	6	2200	5900	200	300	
900	1180	124	122	87	6	6	6	6	3500	9000	170	230	
	1280	190	170	135	7.5	7.5	7.5	7.5	6430	14600	170	220	
950	1250	140	132	100	7.5	7.5	7.5	7.5	4400	10500	160	220	
1000	1420	210	195	150	7.5	7.5	7.5	7.5	8100	18000	140	210	

Designations	Abutment and fillet dimensions							Calculation coefficient				Weight	
	d _a max	d _b min	D _a min	D _a max	D _b min	C _a min	C _b min	e	Y	Y ₀	a		
mm													kg
306/831/HCYB2 306/831/HCR	882	851	995	1080	1067	13	38	0.44	1.36	0.75	209	359	
	882	851	995	1080	1067	13	38	0.44	1.36	0.75	209	397	
318/850X2	892	869	968	1012	1004	13	26	0.44	1.4	0.75	176	140	
319/900X2 306/900/HC	965	920	1092	1160	1142	13	37	0.41	1.49	0.82	194	327	
	990	920	1142	1230	1265	13	55	0.44	1.4	0.74	242	246	
319/950X2/HCR	1023	975	1158	1225	1200	13	40	0.33	1.82	1	183	416	
306/1000	1090	1070	1265	1390	1358	16	20	0.46	1.3	0.72	278	966	

Single-row Tapered Roller Bearing(Inch)

d 17.462~28.575 mm

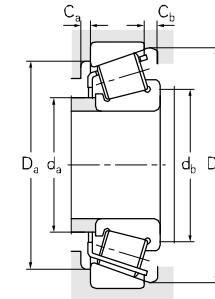
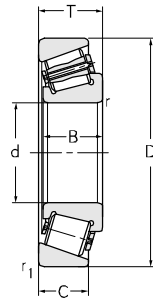
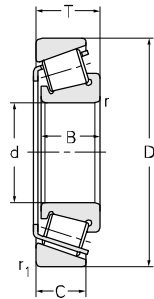

Principal dimensions											
d		D		T		B		C		r _{min}	R _{min}
mm	in	mm	in	mm	in	mm	in	mm	in	mm	
17.462	0.687	39.878	1.57	13.843	0.545	14.605	0.575	10.668	0.42	1.3	1.3
		39.878	1.57	13.843	0.545	14.605	0.575	10.668	0.42	1.3	1.3
19.05	0.75	45.237	1.781	15.494	0.61	16.637	0.655	12.065	0.475	1.2	1.2
		49.225	1.938	18.034	0.71	19.05	0.75	14.288	0.563	1.3	1.3
		49.225	1.938	23.02	0.906	21.539	0.848	17.462	0.687	3.5	1.5
20.625	0.812	49.225	1.938	23.02	0.906	21.539	0.848	17.462	0.687	1.5	1.5
21.43	0.844	45.237	1.781	15.494	0.61	16.637	0.655	12.065	0.475	1.3	1.3
		50.005	1.969	17.526	0.69	18.288	0.72	13.97	0.55	1.3	1.3
		50.005	1.969	17.526	0.69	18.288	0.72	13.97	0.55	1.3	1.3
21.979	0.865	45.237	1.781	15.494	0.61	16.637	0.655	12.065	0.475	1.3	1.3
		45.974	1.81	15.494	0.61	16.637	0.655	12.065	0.475	1.3	1.3
22.225	0.875	50.8	2	15.011	0.591	14.26	0.561	12.7	0.5	1.5	1.5
25.4	1	50.8	2	15.011	0.591	14.26	0.561	12.7	0.5	1.5	1.5
		56.896	2.24	19.368	0.763	19.837	0.781	15.875	0.625	1.3	0.8
		57.15	2.25	17.462	0.687	17.462	0.687	13.495	0.531	1.5	1.3
		57.15	2.25	19.431	0.765	19.431	0.765	14.732	0.58	1.5	1.5
		62	2.441	19.05	0.75	20.638	0.813	14.288	0.563	1.3	1.5
26*		57.15	2.25	17.462	0.687	17.462	0.687	13.495	0.531	1.5	3.5
26.988	1.063	63.5	2.5	20.638	0.813	20.638	0.813	15.875	0.625	1.5	0.8
28*		57.15	2.25	17.462	0.687	17.462	0.687	13.495	0.531	1.5	3.5
28.575	1.125	57.15	2.25	19.845	0.781	19.355	0.762	15.875	0.625	1.5	0.8
		60.325	2.375	19.845	0.781	19.355	0.762	15.875	0.625	1.3	3.5
		64.292	2.531	21.433	0.844	21.433	0.844	16.67	0.656	1.5	1.5
		66.421	2.615	23.812	0.937	25.433	1.001	19.05	0.75	1.3	1.3
		68.262	2.687	22.225	0.875	22.225	0.875	17.462	0.687	1.5	0.8
		73.025	2.875	22.225	0.875	22.225	0.875	17.462	0.687	3.3	0.8

Basic load ratings		Limit speed ratings		Designations	Calculation coefficient				Weight
C _r	C _{0r}	Grease	Oil		e	Y	Y ₀	a	
kN		r/min							kg
25.6	28	9000	13000	KLM11749/KLM11710	0.29	2.1	1.15	9	0.0758
25.6	28	9000	13000	LM11749/LM11710	0.29	2.1	1.15	9	0.0758
31.5	28.9	8500	12000	KLM11949/KLM11910	0.3	2	1.1	10	0.123
37.5	37	8500	12000	K09067/K09195	0.27	2.26	1.24	11	0.176
37.5	37	8500	12000	K09074/K09194	0.27	2.26	1.24	16	0.201
37.5	37	8000	11000	K09081/K09196	0.27	2.26	1.24	12	0.197
29.7	37	8000	11000	KLM12748/KLM12710/YB2	0.31	1.96	1.08	10	0.12
45	43.5	8000	11000	K2M12649/K2M12610	0.28	2.16	1.19	11	0.169
45	43.5	8000	11000	KM12649/KM12610	0.28	2.16	1.19	11	0.169
35.5	40	8000	10000	KLM12749/KLM12710	0.31	1.96	1.08	13	0.116
29.5	34	8000	10000	KLM12749/KLM12711	0.31	1.96	1.08	13	0.118
30.5	33	8000	10000	K07087X/K07210X	0.4	1.49	0.82	12	0.104
31.3	33	7500	10000	K07100S/K07210X	0.4	1.5	0.82	12	0.0908
40	43.5	7000	8800	K1780/K1729	0.31	1.95	1.07	13	0.241
39.4	45.5	7500	10000	K15578/K15520	0.35	1.73	0.95	13	0.214
44.6	45	7500	10000	KM84548/KM84510	0.55	1.1	0.6	16	0.237
47.4	57	7600	9600	K15102/K15245	0.35	1.71	0.94	13	0.298
38	43.5	7500	10000	K15579X/K15520	0.35	1.73	0.95	19	0.207
46	53	7500	9000	K15106/K15250X	0.35	1.71	0.94	15	0.316
38	43.5	7000	9000	KJ15585/K15520	0.35	1.73	0.95	12	0.207
52.9	55	7000	9000	K1985/K1922	0.33	1.82	1	14	0.209
39	42.5	7000	9000	K1988/K1931	0.33	1.82	1	13	0.244
48.5	67.5	7000	9000	KM86647/KM86610	0.55	1.1	0.6	18	0.351
68.5	77	7000	9000	K2689/K2631	0.26	2.28	1.25	14	0.420
53.5	65	7000	9000	K02474/K02420	0.42	1.4	0.79	17	0.410
97	140	7000	9000	K02872/K02820	0.45	1.32	0.73	19	0.825

Note: * indicates the maximum value of IDor OD.

Single-row Tapered Roller Bearing(Inch)

d 29.987~34.925 mm

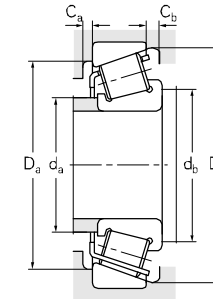
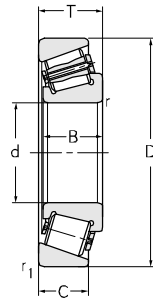
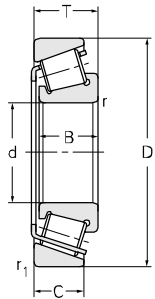

Principal dimensions											
d		D		T		B		C		r _{min}	R _{min}
mm	in	mm	in	mm	in	mm	in	mm	in	mm	
29.987	1.181	72	2.835	19	0.748	18.923	0.745	15.875	0.625	1.5	1.5
30	1.181	72.085	2.838	22.385	0.881	19.202	0.756	18.415	0.725	2.3	0.8
30.162	1.187	62	2.441	16.002	0.63	16.566	0.652	14.288	0.563	1.5	1.5
		64.292	2.531	21.433	0.844	21.433	0.844	16.67	0.656	1.5	1.5
		68.262	2.687	22.225	0.875	22.225	0.875	17.462	0.687	1.5	2.3
		68.262	2.687	22.225	0.875	22.225	0.875	17.462	0.687	2.3	0.8
31.75	1.25	59.131	2.328	15.875	0.625	16.764	0.66	11.811	0.465	1.3	3.6
		59.131	2.328	15.875	0.625	16.764	0.66	11.811	0.465	1.3	3.6
		62	2.441	18.161	0.715	19.05	0.75	14.288	0.563	1.3	4.8
		69.85	2.75	23.812	0.937	25.357	0.998	19.05	0.75	1.3	0.8
		73.025	2.875	29.37	1.156	27.783	1.094	23.02	0.906	3.3	1.3
33.338	1.313	68.262	2.687	22.225	0.875	22.225	0.875	17.462	0.687	1.5	0.8
		68.262	2.687	22.225	0.875	22.225	0.875	17.462	0.687	1.5	0.8
		76.2	3	23.812	0.937	25.654	1.01	19.05	0.75	1.5	3.3
		76.2	3	29.37	1.156	28.575	1.125	23.02	0.906	3.3	0.8
34.925	1.375	65.088	2.563	18.034	0.71	18.288	0.72	13.97	0.55	1.3	3.6
		65.088	2.563	18.034	0.71	18.288	0.72	13.97	0.55	1.3	3.6
		65.088	2.563	18.034	0.71	18.288	0.72	13.97	0.55	1.3	4.7
		69.012	2.717	19.845	0.781	19.583	0.771	15.875	0.625	3.3	3.5
		69.012	2.717	19.845	0.781	19.583	0.771	15.875	0.625	3.5	0.8
		72.233	2.844	25.4	1	25.4	1	19.842	0.781	2.3	2.3
		72.233	2.844	25.4	1	25.4	1	19.842	0.781	2.3	2.3
		73.025	2.875	23.812	0.937	24.608	0.969	19.05	0.75	0.8	0.5
		73.025	2.875	23.812	0.937	24.608	0.969	19.05	0.75	2.3	1.5
		73.025	2.875	23.812	0.937	24.608	0.969	19.05	0.75	0.8	1.5
		73.025	2.875	23.812	0.937	24.608	0.969	19.05	0.75	0.8	3.5
		76.2	3	29.37	1.156	28.575	1.125	23.812	0.937	3.3	1.5
		76.2	3	23.812	0.937	25.654	1.01	19.05	0.75	3.3	3.5

Basic load ratings		Limit speed ratings		Designations	Calculation coefficient				Weight
C _r	C _{0r}	Grease	Oil		e	Y	Yo	a	
kN		r/min							kg
50	53	7000	8500	K26118/K26283	0.36	1.67	0.92	14	0.384
46	55.5	7000	8500	K14118/K14283	0.38	1.57	0.86	17	0.202
40	43.5	7000	8500	K17119/K17244B	0.38	1.57	0.86	14	0.228
54.9	61	7000	8500	KM86649/KM86610	0.55	1.1	0.6	18	0.339
61.7	69.5	5600	7500	KM88043/KM88010	0.55	1.1	0.6	19	0.411
61.7	69.5	5600	7500	KM88043/KM88012	0.55	1.1	0.6	19	0.412
40	50	6300	8500	KLM67048A6/KLM67010A6	0.41	1.46	0.8	13	0.175
44	50	6300	8500	KLM67048/KLM67010	0.41	1.46	0.8	13	0.175
56.5	62	6300	8500	K15123/K15245	0.35	1.71	0.94	13	0.242
71.5	85.5	6300	8500	K2580/K2523	0.27	2.2	1.2	15	0.451
70.5	95	6300	8500	KHM88542/KHM88510	0.55	1.1	0.6	23	1
61.7	69.5	6300	7500	KM88048/KM88010	0.55	1.1	0.6	19	0.382
61.7	69.5	6300	7500	KM88048/KM88010-2-GKN	0.55	1.1	0.6	19	0.382
90	110	5600	7500	K2790/K2720	0.3	1.98	1.09	16	0.559
82	110	5600	7500	KHM89443/KHM89410	0.55	1.1	0.6	24	0.774
52.9	60	5600	7500	KLM48548/KLM48510	0.38	1.59	0.88	14	0.260
52.9	60	5600	7500	KLM48548/KLM48510A6	0.38	1.59	0.88	14	0.261
52.9	60	5600	7500	LM48548/LM48510	0.38	1.59	0.88	14	0.26
52.8	67	5600	7500	K14138A/K14274	0.38	1.57	0.86	14	0.320
52.8	67	5600	7500	K14138A/K14276B	0.38	1.57	0.86	15	0.333
76.4	90	5000	7100	KHM88649/KHM88610	0.55	1.1	0.6	21	0.480
76.4	90	5000	6700	KHM88649/KHM88610-HQ	0.54	1.1	0.6	20	0.473
71.5	85	5600	7500	K25877A6/K25821	0.29	2.07	1.13	16	0.475
71.5	85	5600	7500	K25877/K25820	0.29	2.07	1.13	16	0.475
71.5	85	5600	7500	K25877/K25821	0.29	2.07	1.14	14	0.475
71.5	85	5600	7500	K25878/K25821	0.29	2.07	1.14	14	0.475
84.1	106	5600	7500	K31594SH/K31520SH	0.4	1.49	0.82	21	2.13
90	110	5600	7500	K2796/K2720	0.3	1.98	1.09	16	0.508

Note: * indicates the maximum value of IDor OD.

Single-row Tapered Roller Bearing(Inch)

d 34.925~39.688 mm

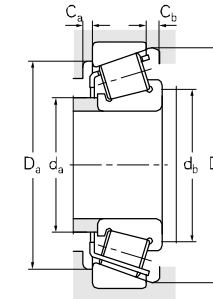
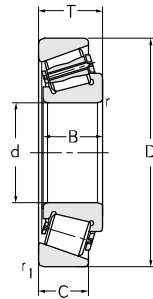
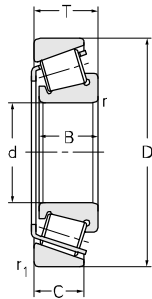

Principal dimensions											
d		D		T		B		C		r _{min}	R _{min}
mm	in	mm	in	mm	in	mm	in	mm	in	mm	
34.925		76.2	3	29.37	1.156	28.575	1.125	23.02	0.906	3.3	3.5
		79.375	3.125	29.37	1.156	29.771	1.172	23.812	0.937	3.3	3.5
		95.25	3.75	11.115	0.438	29.9	1.177	22.225	0.875	0.8	2.3
35*		59.131	2.328	15.875	0.625	16.764	0.66	11.938	0.47	1.3	3.5
		59.974	2.361	15.875	0.625	16.764	0.66	11.938	0.47	1.3	3.5
		62*		16.7	0.657	17	0.669	13.6	0.535	1.5	SP
		62*		16.7	0.657	17	0.669	13.6	0.535	1.5	SP
36.487	1.436	76.2	3	23.812	0.937	25.654	1.01	19.05	0.75	3.3	1.5
36.512	1.437	72.238	2.844	20.638	0.813	20.638	0.813	18.575	0.731	1.3	3.5
		76.2	3	29.37	1.156	28.575	1.125	23.02	0.906	3.3	0.8
		76.2	3	29.37	1.156	28.575	1.125	23.02	0.906	3.3	3.5
38	1.496	63	2.48	17	0.669	19	0.748	13.5	0.531	1.3	1.3
		63	2.48	17	0.669	17	0.669	13.5	0.531	1.3	1.3
38.1	1.5	65.088	2.563	18.034	0.71	18.288	0.72	13.97	0.55	1.3	2.3
		65.088	2.563	18.034	0.71	18.288	0.72	13.97	0.55	1.1	2.3
		65.088	2.563	19.812	0.78	18.288	0.72	15.748	0.62	1.3	2.3
		69.012	2.717	26.195	1.031	26.195	1.031	15.083	0.594	0.8	1.5
		72.238	2.844	20.638	0.813	20.638	0.813	15.875	0.625	1.3	3.5
		76.2	3	23.812	0.937	25.654	1.01	19.05	0.75	3.3	3.5
		79.375	3.125	29.37	1.156	29.771	1.172	23.812	0.937	3.3	3.5
		88.5	3.484	26.988	1.063	29.083	1.145	22.225	0.875	1.5	3.5
		88.5	3.484	25.4	1	23.698	0.933	17.462	0.687	1.5	2.3
39*		72.014	2.835	21.4	0.843	20.638	0.813	16.637	0.655	0.4	3.5
39.688	1.563	73.025	2.875	23.812	0.937	25.654	1.01	19.05	0.75	0.8	3.5
		73.025	2.875	25.654	1.01	22.098	0.87	21.336	0.84	2.3	0.8
		76.2	3	23.812	0.937	25.654	1.01	19.05	0.75	3.3	3.5
		76.2	3	23.812	0.937	25.645	1.01	19.05	0.75	0.8	3.5
		76.2	3	23.812	0.937	25.654	1.01	19.05	0.75	0.8	3.5

Basic load ratings		Limit speed ratings		Designations	Calculation coefficient				Weight
C _r	C _{0r}	Grease	Oil		e	Y	Y ₀	a	
kN		r/min							kg
84.1	106	5600	7500	KHM89446/KHM89410	0.55	1.1	0.6	24	0.670
87.5	106	5600	7500	K3478/K3420	0.37	1.64	0.9	20	0.695
108	129	5600	7500	K449/K432B	0.28	2.11	1.16	19	1.16
34	36	5600	7000	KL68149/KL68110	0.42	1.44	0.79	13	0.166
34.5	24.5	5600	7000	KL68149/KL68111	0.42	1.44	0.79	13	0.166
41.5	53.5	5600	7500	KLM78349/KLM78310A	0.44	1.4	0.74	14	0.206
41.5	53.5	5600	7500	KLM78349SH/KLM78310ASH	0.44	1.35	0.74	14	0.206
90	110	5000	6700	K2780/K2720	0.3	2	1.1	16	0.526
45	61	4800	6300	K16143/K16284	0.4	1.49	0.82	17	0.362
88.2	106	4800	6300	KHM89448/KHM89410	0.55	1.1	0.6	23	0.650
88.2	106	4800	6300	KHM89449/KHM89410	0.55	1.1	0.6	23	0.65
36	56	5800	7400	KJL69345/KJL69310	0.42	1.44	0.79	14	0.211
36	56	5800	7400	KJL69349/KJL69310	0.42	1.44	0.79	14	0.205
49	57	5000	7000	KLM29749/KLM29710	0.33	1.8	0.99	12	0.237
49	57	5000	7000	KLM29749/KLM29710-DZ	0.33	1.8	0.99	12	0.241
49	57	5000	7000	KLM29749/KLM29711	0.33	1.8	0.99	16	0.251
49.5	62	5000	7000	K13686/K13620	0.4	1.49	0.82	16	0.362
54.9	60	5000	7000	K16150/K16284	0.4	1.49	0.82	17	0.345
90	110	5000	7000	K2788/K2720	0.3	1.98	1.09	17	0.507
102	110	5000	7000	K3490/K3420	0.37	1.64	0.9	20	0.653
100	113	5000	6000	K418/K414	0.26	2.28	1.25	18	0.843
76	86	5000	6000	K44150/K44348	0.78	0.77	0.42	28	0.718
49.5	61	4500	6000	KJ16154/KJ16285	0.4	1.49	0.82	17	0.341
90	110	4500	6000	K2789/K2735X	0.3	1.98	1.09	16	0.413
75	86.5	4500	6000	KM201047/KM201011	0.33	1.79	0.99	20	0.437
90	110	4500	6000	K2789/K2720	0.3	1.98	1.09	17	0.468
90	110	4500	6000	K2789/K2729	0.3	1.98	1.09	16	0.507
90	110	4500	6000	K2789SH/K2729SH	0.3	1.98	1.09	16	0.507

Note: * indicates the maximum value of IDor OD.

Single-row Tapered Roller Bearing(Inch)

d 40-44.45 mm

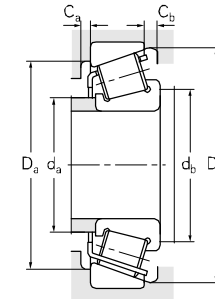
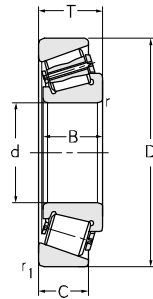
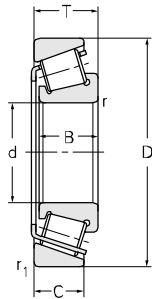

Principal dimensions											
d		D		T		B		C		r _{min}	R _{min}
mm	in	mm	in	mm	in	mm	in	mm	in	mm	
40	1.575	90.119	3.548	23	0.906	21.962	0.865	21.808	0.859	2.3	0.8
40.988	1.614	68*		17.5	0.689	18	0.709	13.5	0.531	0.8	3.6
41*		68*		17.5	0.689	18	0.709	13.5	0.531	1.5	3.6
41.275	1.625	73.025	2.875	16.667	0.656	17.462	0.687	12.7	0.5	1.5	3.5
		73.431	2.891	19.558	0.77	19.812	0.78	14.732	0.58	0.76	3.56
		73.431	2.891	19.558	0.77	19.812	0.78	14.732	0.58	0.76	3.56
		73.431	2.891	21.43	0.844	19.812	0.78	16.604	0.654	0.8	3.5
		76.2	3	18.009	0.709	17.384	0.684	14.288	0.563	1.5	1.5
		76.2	3	22.225	0.875	23.02	0.906	17.462	0.687	0.8	3.5
		80	3.15	21	0.827	22.403	0.882	17.826	0.702	1.3	0.8
		80.167	3.156	29.37	1.156	30.391	1.196	23.812	0.937	3.3	0.8
		82.55	3.25	26.543	1.045	25.654	1.01	20.193	0.795	3.3	3.5
		82.55	3.25	26.543	1.045	25.654	1.01	20.193	0.795	3.3	3.5
		82.55	3.25	26.543	1.045	25.654	1.01	20.193	0.795	3.3	3.5
		87.312	3.437	30.162	1.187	30.866	1.215	23.812	0.937	1.5	3.3
		88.5	3.484	26.988	1.063	29.083	1.145	22.225	0.875	1.5	3.5
		88.9	3.5	30.162	1.187	29.37	1.156	23.02	0.906	3.3	3.5
		104.775	4.125	36.512	1.437	36.512	1.437	28.575	1.125	3.3	1.5
42.862	1.687	82.55	3.25	26.195	1.031	26.988	1.063	20.638	0.813	3.3	3.5
42.875	1.688	80	3.15	21	0.827	22.403	0.882	17.826	0.702	2	3.5
		82.931	3.265	26.988	1.063	25.4	1	22.225	0.875	2.3	3.5
43*		80*		21.001	0.827	22.403	0.882	17.826	0.702	0.8	3.5
44.45	1.75	82.931	3.265	23.812	0.937	25.4	1	19.05	0.75	0.8	3.5
		82.931	3.265	23.812	0.937	25.4	1	19.05	0.75	0.8	0.5
		87.312	3.437	30.162	1.187	30.886	1.216	23.812	0.937	3.3	3.5
		87.312	3.437	30.162	1.187	30.886	1.216	23.812	0.937	3.3	3.6
		88.9	3.5	30.162	1.187	29.37	1.156	23.02	0.906	3.3	3.5

Basic load ratings		Limit speed ratings		Designations	Calculation coefficient				Weight
C _r	C _{0r}	Grease	Oil		e	Y	Y ₀	a	
kN		r/min							kg
73	83.5	4500	5700	K350A/K352	0.31	1.96	1.08	18	0.715
49.0	66.0	4500	6000	KLM300849/KLM300811-DZ	0.35	1.72	0.95	14	0.252
51	60	4500	6000	KLM300849/KLM300811	0.35	1.72	0.95	14	0.241
52.9	56	4500	6000	K18590/K18520	0.35	1.71	0.94	14	0.282
67	73.5	4500	6000	KLM501349/KLM501310	0.4	1.5	0.83	15	0.353
67	73.5	4500	6000	KLM501349/KLM501310-2-GKN	0.4	1.5	0.83	15	0.353
67	73.5	4500	6000	KLM501349/KLM501314	0.4	1.5	0.83	17	0.360
50.5	61.5	4500	6000	K11162/K11300	0.49	1.2	0.68	17	0.343
71	83.5	4500	6000	K24780/K24720	0.4	1.5	0.84	17	0.429
68.5	76	4500	6000	K336/K332	0.27	2.2	1.21	15	0.453
97	114	4500	6000	K3384/K3320	0.27	2.2	1.21	17	0.630
85	107	4500	6000	KM802048/KM802011-2-GKN	0.55	1.1	0.6	23	0.623
84	105	4500	6000	KM802048SH/KM802011SH	0.54	1.1	0.6	22	0.623
85	107	4500	6000	K1M802048/K1M802011	0.55	1.1	0.6	23	0.623
129	175	4500	6000	K3585/K3525	0.53	1.14	0.62	24	0.861
100	113	5000	6000	K419/K414	0.26	2.28	1.25	18	0.804
106	127	4300	5600	KHM803146/KHM803110	0.54	1.1	0.6	26	0.915
146	194	4300	5600	K59162/K59412	0.4	1.49	0.82	26	1.69
84.5	119	4500	6000	K22780/K22720	0.4	1.49	0.82	20	0.687
69	76	4500	6000	K342S/K332US	0.27	2.2	1.21	15	0.432
78	101	4500	6000	K25577/K25523	0.33	1.79	0.99	19	0.646
69	76	4500	6000	K342X/K332B	0.27	2.2	1.21	15	0.440
79.3	106	4500	6000	K25580/K25520	0.33	1.79	0.99	18	0.573
79.3	106	4500	6000	K25581/K25520	0.33	1.79	0.99	18	0.573
95	143	4500	5600	K3578/K3525	0.31	1.96	1.08	20	0.81
114	120	4500	5600	K3578R/K3525-1	0.31	1.96	1.08	20	0.772
106	127	4500	5600	KHM803149/KHM803110	0.55	1.1	0.6	26	0.865

Note: * indicates the maximum value of IDor OD.

Single-row Tapered Roller Bearing(Inch)

d 44.45~45.987 mm

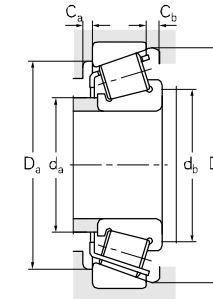
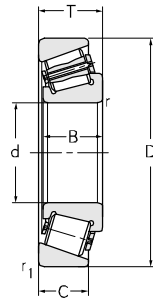
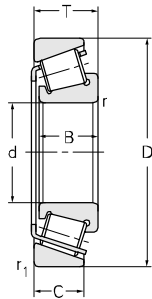

Principal dimensions											
d		D		T		B		C		r _{min}	R _{min}
mm	in	mm	in	mm	in	mm	in	mm	in	mm	
44.45		90.119	3.548	23	0.906	21.692	0.854	21.808	0.859	2.3	3.5
		92.075	3.625	30.162	1.187	29.37	1.156	23.02	0.906	3.3	3.5
		93.264	3.672	30.162	1.187	30.302	1.193	23.812	0.937	3.3	3.5
		93.264	3.672	30.162	1.187	30.302	1.193	23.812	0.937	3.3	3.5
		95.25	3.75	27.783	1.094	28.575	1.125	22.225	0.875	0.8	2
		95.25	3.75	27.783	1.094	28.575	1.125	22.225	0.875	0.8	0.8
		95.25	3.75	30.162	1.187	29.37	1.156	23.02	0.906	3.3	3.5
		95.25	3.75	30.958	1.219	28.575	1.125	22.225	0.875	0.8	3.5
		95.25	3.75	30.958	1.219	28.575	1.125	22.225	0.875	0.8	3.5
		101.6	4	34.925	1.375	36.068	1.42	26.988	1.063	3.3	3.5
		104.7754	4.125	30.162	1.187	30.958	1.219	23.812	0.937	3.3	0.8
		104.7754	4.125	36.512	1.437	36.512	1.437	28.575	1.125	3.3	3.5
		104.7754	4.125	36.512	1.437	36.512	1.437	28.575	1.125	3.3	3.5
44.988	1.771	104.9864	4.133	32.512	1.28	31.75	1.25	23.368	0.92	2.5	2.5
45.23	1.781	79.985	3.149	19.842	0.781	20.638	0.813	15.08	0.594	1.3	2
		84.138	3.313	30.162	1.187	30.886	1.216	23.812	0.937	3.3	3.5
		87.312	3.437	30.162	1.187	30.886	1.216	23.812	0.937	3.3	3.5
45.242	1.781	73.431	2.891	19.558	0.77	19.812	0.78	15.748	0.62	0.8	3.5
		77.788	3.063	19.842	0.781	19.842	0.781	15.08	0.594	0.8	3.5
		77.788	3.063	21.43	0.844	19.842	0.781	16.667	0.656	0.8	3.5
45.618	1.796	82.931	3.265	23.812	0.937	25.4	1	19.05	0.75	0.8	3.5
		82.931	3.265	26.988	1.063	25.4	1	22.225	0.875	2.3	3.5
		82.931	3.265	23.812	0.937	25.4	1	19.05	0.75	0.8	3.5
		83.058	3.27	23.876	0.94	25.4	1	19.114	0.753	2	3.5
		83.058	3.27	23.876	0.94	25.4	1	19.114	0.753	2	3.5
45.987	1.811	74.976	2.952	18	0.709	18	0.709	14	0.551	1.6	2.3
		75*		18	0.709	18	0.709	14	0.551	1.6	2.3

Basic load ratings		Limit speed ratings		Designations	Calculation coefficient				Weight
C _r	C _{Or}	Grease	Oil		e	Y	Yo	a	
kN		r/min							kg
71.5	85	4500	6000	K355X/K352	0.31	1.96	1.08	18	0.668
90	125	4500	6000	KHM803149/KHM803112	0.55	1.1	0.6	26	0.953
103	140	4500	6000	K3782/K3720	0.34	1.77	0.98	22	1.04
103	140	4500	6000	K3782SH/K3720SH	0.34	1.77	0.98	22	1.04
110	140	3800	5300	K33885A6/K33822	0.33	1.79	0.99	24	1.31
110	140	3800	5300	K33885/K33822	0.33	1.79	0.99	24	0.983
107	144	3800	5300	KHM804843/KHM804810-HQ	0.55	1.1	0.6	26	1.01
111	133	4500	6000	KHM903249/KHM903210	0.74	0.81	0.45	32	1.00
101	133	3600	4800	KHM903249/KHM903210-2X	0.75	0.8	0.45	30	1.00
136	168	4500	6000	K527/K522	0.29	2.1	1.16	22	1.36
126	166	4300	5600	K45280/K45220	0.33	1.8	0.99	22	1.25
167	204	4300	5600	K59175/K59412	0.4	1.49	0.82	26	1.63
127	192	4300	5600	KHM807040/KHM807010	0.49	1.23	0.68	29	1.62
127	164	4500	6000	KHM905843/KHM905810	0.78	0.77	0.42	34	1.41
58	76	4500	6000	K17887/K17831	0.37	1.64	0.9	16	0.406
114	120	4500	6000	K3586/K3520-1	0.31	1.96	1.08	20	0.684
114	120	4500	6000	K3586/K3525-1	0.31	1.97	1.08	20	0.758
60.8	75	4500	6000	KLM102949/KLM102910	0.31	1.97	1.08	14	0.318
60.8	69.5	4800	6300	KLM603049/KLM603011	0.43	1.41	0.77	17	0.363
51	71	4800	6300	KLM603049/KLM603012	0.43	1.4	0.77	19	0.358
79.3	106	4500	6000	K25590/K25520	0.33	1.79	0.99	18	0.556
77	100	4500	6000	K25590/K25523	0.33	1.79	0.99	18	0.589
79.3	106	4500	5000	K25590SH/K25520SH	0.33	1.79	0.99	18	0.556
79.3	106	4500	5000	K25590/K25522	0.33	1.79	0.99	18	0.556
79.3	106	4500	5000	K25590SH/K25522SH	0.33	1.79	0.99	21	0.556
53	75	4800	6300	KLM503349/KLM503310-2-GKN	0.4	1.49	0.82	16	0.305
57	79.5	4800	6300	KLM503349/KLM503310-DZ	0.4	1.49	0.82	16	0.305

Note: * indicates the maximum value of ID or OD.

Single-row Tapered Roller Bearing(Inch)

d 46.038~50.8 mm

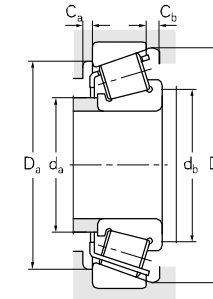
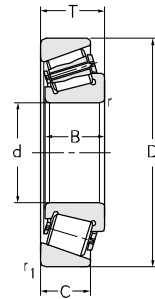
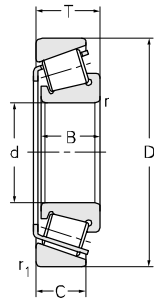

Principal dimensions											
d		D		T		B		C		r _{min}	R _{min}
mm	in	mm	in	mm	in	mm	in	mm	in	mm	
46.038	1.813	79.375	3.125	17.462	0.687	17.462	0.687	13.495	0.531	1.5	2.8
		85	3.346	20.638	0.813	21.692	0.854	17.462	0.687	1.3	2.3
		85	3.346	20.638	0.813	21.692	0.854	17.462	0.687	1.5	2.3
47.625	1.875	93.264	3.672	30.162	1.187	30.302	1.193	23.812	0.937	3.3	3.5
		95.25	3.75	30.162	1.187	29.37	1.156	23.02	0.906	3.3	3.5
		104.775	4.125	30.162	1.187	30.958	1.219	23.812	0.937	3.3	3.5
		123.825	4.875	36.512	1.437	32.791	1.291	25.4	1	3.3	3.5
48.412	1.906	95.25	3.75	30.162	1.187	29.37	1.156	23.02	0.906	3.3	2.3
49.212	1.937	114.3	4.5	44.45	1.75	44.45	1.75	36.068	1.42	3.3	3.5
49.987	1.968	92.075	3.625	24.607	0.969	25.4	1	19.845	0.781	0.8	2.3
50*		83*		22	0.866	22	0.866	17.5	0.689	1.5	3.5
		93.264	3.672	30.162	1.187	30.302	1.193	23.812	0.937	3.3	3.5
		105*		37	1.457	36	1.417	29	1.142	3	2.5
50	1.969	90	3.543	28	1.102	28	1.102	23	0.906	2.5	3
		105	4.134	32	1.26	29	1.142	22	0.866	3	3
		112.712	4.437	26.967	1.062	21.996	0.866	23.812	0.937	3.3	0.8
50.8	2	82.55	3.25	21.59	0.85	22.225	0.875	16.51	0.65	1.3	3.5
		85	3.346	17.462	0.687	17.462	0.687	13.495	0.531	1.5	3.5
		85	3.346	17.462	0.687	17.462	0.687	13.495	0.531	1.5	3.5
		88.9	3.5	20.638	0.813	22.225	0.875	16.513	0.65	1.3	3.5
		90	3.543	25	0.984	22.225	0.875	20	0.787	2	3.5
		92.075	3.625	24.608	0.969	25.4	1	19.845	0.781	0.8	3.5
		93.264	3.672	30.162	1.187	30.162	1.187	23.812	0.937	0.8	0.8
		93.264	3.672	30.162	1.187	30.162	1.187	23.812	0.937	3.3	3.5
		95.25	3.75	27.783	1.094	28.575	1.125	22.225	0.875	0.8	5
		95.25	3.75	27.783	1.094	28.575	1.125	22.225	0.875	0.8	3.5
	96.838	3.813	21	0.827	21.946	0.864	15.875	0.625	0.8	2.3	

Basic load ratings		Limit speed ratings		Designations	Calculation coefficient				Weight
C _r	C _{0r}	Grease	Oil		e	Y	Y ₀	a	
kN		r/min							kg
55.9	62	4500	6000	K18690/K18620	0.37	1.6	0.88	16	0.325
80	81.5	4500	6000	K359S/K354A	0.31	1.9	1.1	16	0.770
80	81.5	4500	6000	K359S/K354X	0.31	1.9	1.1	16	0.770
103	140	3800	5300	K3779/K3720	0.34	1.77	0.98	21	0.921
107	144	3800	5300	KHM804846/KHM804810	0.55	1.1	0.6	26	0.987
126	166	3900	4900	K45282/K45220	0.33	1.8	0.99	22	1.29
142	189	3000	4000	K72187C/K72487	0.74	0.81	0.45	37	2.25
107	144	4100	5200	KHM804848/KHM804810	0.55	1.1	0.6	26	0.967
208	224	3600	4600	KHH506348/KHH506310-2	0.4	1.5	0.83	30	2.24
86	119	4200	5300	K28579/K28521	0.38	1.59	0.88	20	0.702
71	96.5	4000	5000	KJLM704649/KJLM704610	0.44	1.37	0.75	20	0.474
113	136	4000	5000	K50KW01/K3720	0.34	1.77	0.98	23	0.928
140	192	4000	5000	KJHM807045/KJHM807012	0.49	1.23	0.68	29	1.39
106	142	4200	5300	KJM205149/KJM205110	0.33	1.83	1.01	20	0.758
111	140	3800	4800	KJW5049/KJW5010	0.87	0.69	0.38	37	1.22
80	105	3600	4600	K396/K3920	0.4	1.49	0.82	26	1.27
70.7	100	4500	6000	KLM104949/KLM104911	0.31	1.97	1.08	16	0.417
50.5	66.5	4000	5000	K18790/K18720	0.41	1.48	0.81	63	0.378
50	60	4000	5000	K18790/K18720B	0.41	1.48	0.81	63	0.388
75.5	89	4000	5000	K368A/K362A	0.32	1.88	1.03	17	0.520
86.2	91.5	4000	5000	K368A/K362X	0.32	1.88	1.03	17	0.601
86.5	119	4000	5000	K28580/K28521	0.38	1.59	0.88	18	0.701
124	158	4000	5000	K3775/K3730	0.34	1.77	0.98	22	0.870
124	158	4000	4500	K3780/K3720	0.34	1.77	0.98	22	0.870
110	140	4000	4500	K33889A6/K33822	0.33	1.79	0.99	24	1.2
110	140	4000	4500	K33889/K33822	0.33	1.79	0.99	24	0.877
84	108	4000	5000	K385A/K382A	0.35	1.69	0.93	18	0.678

Note: * indicates the maximum value of IDor OD.

Single-row Tapered Roller Bearing(Inch)

d 50.8-54.488 mm

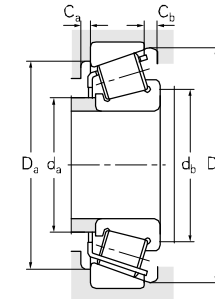
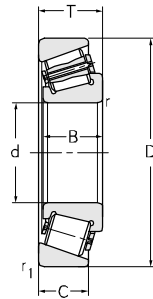
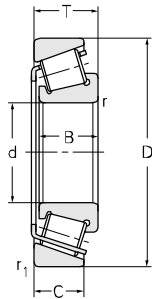

Principal dimensions											
d		D		T		B		C		r _{min}	R _{min}
mm	in	mm	in	mm	in	mm	in	mm	in	mm	
50.8		101.6	4	31.75	1.25	31.75	1.25	25.4	1	0.8	3.5
		104.775	4.125	36.512	1.437	36.512	1.437	28.575	1.125	3.3	3.5
		104.775	4.125	36.512	1.437	36.512	1.437	28.575	1.125	3.3	3.5
		104.775	4.125	36.512	1.437	36.512	1.437	28.575	1.125	3.3	3.5
		104.775	4.125	30.162	1.187	30.958	1.219	23.812	0.937	3.3	6.4
		104.775	4.125	30.162	1.187	30.958	1.219	23.812	0.937	3.3	0.8
		104.775	4.125	30.162	1.187	30.958	1.219	23.812	0.937	0.8	2.3
		107.95	4.25	32.558	1.282	29.317	1.154	27	1.063	0.8	0.8
		107.95	4.25	27.795	1.094	29.317	1.154	27	1.063	0.8	0.8
		107.95	4.25	27.783	1.094	29.317	1.154	22.225	0.875	0.8	0.8
		107.95	4.25	27.782	1.094	29.317	1.154	22.225	0.875	0.8	3.5
		107.95	4.25	36.512	1.437	36.957	1.455	28.575	1.125	3.3	3.5
		112.712	4.437	33.338	1.313	30.048	1.183	26.988	1.063	3.3	3.5
		123.825	4.875	36.512	1.437	32.791	1.291	25.4	1	3.3	3.5
		123.825	4.875	36.512	1.437	32.791	1.291	25.4	1	3.3	3.5
51.75	2.037	104.775	4.125	30.162	1.187	29.317	1.154	24.605	0.969	3.3	2.3
52.388	2.063	92.075	3.625	24.608	0.969	25.4	1	19.845	0.781	0.8	3.5
		92.075	3.625	24.608	0.969	25.4	1	19.845	0.781	0.8	3.5
53.975	2.125	88.9	3.5	19.05	0.75	19.05	0.75	13.492	0.531	2	2.3
		100	3.937	21	0.827	21.946	0.864	17.862	0.703	2	0.8
		104.775	4.125	36.512	1.437	36.512	1.437	28.575	1.125	3.3	3.5
		107.95	4.25	36.512	1.437	36.957	1.455	28.575	1.125	0.5	3.5
		123.825	4.875	36.512	1.437	32.791	1.291	25.4	1	3.3	3.6
		123.825	4.875	36.512	1.437	32.791	1.291	25.4	1	3.3	3.5
		130.175	5.125	36.512	1.437	33.338	1.313	23.812	0.937	3.3	3.5
54.488	2.145	104.775	4.125	36.512	1.437	36.512	1.437	28.575	1.125	3.3	3.5
		104.775	4.125	36.512	1.437	36.512	1.437	28.575	1.125	3.3	3.5

Basic load ratings		Limit speed ratings		Designations	Calculation coefficient				Weight
C _r	C _{Or}	Grease	Oil		e	Y	Yo	a	
kN		r/min							kg
120	151	4000	4500	K49585/K49522	0.4	1.5	0.82	23	1.13
140	192	3500	4500	KHM807046/KHM807010	0.49	1.23	0.68	29	1.48
140	192	3500	4500	KHM807046/KHM807010-2	0.49	1.23	0.68	29	1.48
146	194	3500	4500	K59200/K59412	0.4	1.49	0.82	26	1.49
127	166	3500	4500	K45284/K45220	0.33	1.8	0.99	22	1.23
127	166	3500	4500	K45285ASH/K45220SH	0.33	1.8	0.99	22	1.23
115	166	3500	4500	K45285/K45221	0.33	1.8	0.99	22	1.23
110	143	3700	4700	K455/K452	0.34	1.79	0.98	26	1.38
110	143	3500	4500	K455/K453	0.34	1.79	0.98	21	1.30
110	143	3500	4500	K455/K453A	0.34	1.79	0.98	21	1.24
110	143	3500	4500	K455S/K453B-3	0.34	1.79	0.98	21	1.3
153	190	3700	4700	K537/K532X	0.3	2.02	1.11	24	1.54
115	170	3600	4500	K3975/K3926	0.4	1.49	0.82	29	1.62
142	189	2800	4000	K72200C/K72487	0.74	0.81	0.45	38	2.13
142	189	2800	4000	K72200C/K72487-3	0.74	0.81	0.45	38	2.13
100	145	3500	4500	K462/K453X	0.34	1.79	0.98	25	1.05
86.5	119	3500	4000	K28584A6/K28521	0.38	1.59	0.88	18	0.678
86.5	119	3500	4000	K28584/K28521	0.38	1.59	0.88	18	0.678
65.7	78	4100	5200	KLM806649/KLM806610-2-AAM	0.55	1.1	0.6	21	0.431
82.5	103	3000	4000	K389A/K383A	0.35	1.69	0.93	19	0.692
127	192	3000	4000	KHM807049/KHM807010	0.49	1.23	0.68	29	1.41
153	190	3000	4000	K539/K532XA6	0.3	2.02	1.11	23	1.47
156	190	2800	4000	K72212CA6/K72487-2	0.74	0.81	0.45	38	2.12
142	189	2800	4000	K72212C/K72487	0.74	0.81	0.45	38	2.12
153	168	3000	4000	KHM911242SH/KHM911210SH	0.81	0.74	0.41	41	2.24
140	192	3000	4000	KHM807048/KHM807010	0.49	1.23	0.68	29	1.39
146	204	3000	4000	KHM807048YB2/KHM807010	0.49	1.23	0.68	29	1.39

Note: * indicates the maximum value of IDor OD.

Single-row Tapered Roller Bearing(Inch)

d 55-60.325 mm

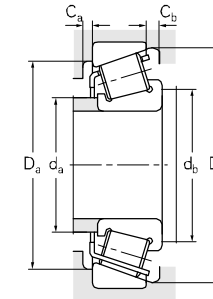
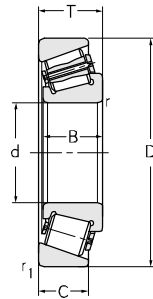
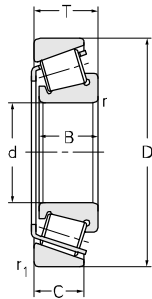

Principal dimensions											
d		D		T		B		C		r _{min}	R _{min}
mm	in	mm	in	mm	in	mm	in	mm	in	mm	
55	2.165	90	3.543	23	0.906	23	0.906	18.5	0.728	0.5	1.5
		120	4.724	29.002	1.142	29.007	1.142	23.444	0.923	3.3	0.8
55*	90*			23	0.906	23	0.906	18.5	0.728	0.5	1.5
	90*			23	0.906	23	0.906	18.5	0.728	0.5	1.5
	90	3.5433		23	0.906	23	0.906	18.5	0.728	0.5	1.5
	95*			29	1.142	29	1.142	23.5	0.925	2.5	1.5
	110*			39	1.535	39	1.535	32	1.26	2.5	3
55.562	2.187	97.63	3.844	24.608	0.969	24.608	0.969	19.446	0.766	0.8	3.5
56*	95		3.7402	29	1.142	29	1.142	23.5	0.925	2.5	1.5
57.15	2.25	96.838	3.813	21	0.827	21.946	0.864	15.875	0.625	0.8	3.5
		96.838	3.813	21	0.827	21.946	0.864	15.875	0.625	0.8	5
		97.63	3.844	24.608	0.969	24.608	0.969	19.446	0.766	0.8	3.5
		104.775	4.125	30.162	1.187	29.317	1.154	24.605	0.969	3.3	2.3
		104.775	4.125	32.545	1.281	29.317	1.154	26.988	1.063	3.3	3.5
		104.775	4.125	30.162	1.187	29.317	1.154	24.605	0.969	3.3	3.5
		112.712	4.437	26.967	1.062	21.996	0.866	23.812	0.937	3.3	2.3
		123.825	4.875	38.1	1.5	36.678	1.444	30.162	1.187	3.3	3.5
		140.03	5.513	36.512	1.437	33.236	1.309	23.52	0.926	2.3	3.5
59.987	2.362	146.05	5.75	41.275	1.625	39.688	1.563	25.4	1	3.3	3.5
		146.05	5.75	41.275	1.625	39.688	1.563	25.4	1	3.3	3.5
		130.175	5.125	36.513	1.438	30.924	1.217	23.812	0.937	3.3	3.5
60*	112.712	4.4375	30.162	1.187	30.048	1.183	23.812	0.937	3.3	3.5	
	135	5.3147	33.45	1.317	30.95	1.219	22	0.866	3.5	3.5	
60	2.362	120	4.724	29.795	1.173	29.007	1.142	24.237	0.954	2	2
		125	4.921	37	1.457	33.5	1.319	26	1.024	3	3
60.325	2.375	100	3.937	25.4	1	25.4	1	19.845	0.781	3.3	3.5

Basic load ratings		Limit speed ratings		Designations	Calculation coefficient				Weight
C _r	C _{Or}	Grease	Oil		e	Y	Yo	a	
kN		r/min							kg
81	114	4100	5100	KJLM506849SH/KJLM506810SH/YB2-3 K475/K472A	0.4	1.5	0.8	20	0.553
135	188	3400	4300		0.38	1.56	0.86	25	1.64
78	113	3000	4000	KJLM506849/KJLM506810	0.4	1.5	0.82	20	0.568
78	113	3000	4000	KJLM506849/KJLM506810-2	0.4	1.5	0.82	20	0.568
81	114	4000	5300	KJLM506849SH/KJLM506810SH-3	0.4	1.5	0.8	20	0.553
77	152	3000	4000	KJM207049/KJM207010	0.33	1.8	0.99	21	0.831
164	203	3000	4000	KJH307749/KJH307710	0.35	1.69	0.93	26	1.69
89.5	129	3000	4000	K28680/K28622	0.4	1.49	0.82	21	0.760
110	152	3000	4000	KJM207049/KJM207010-3	0.33	1.8	0.99	21	0.831
82.5	103	3000	4000	K387A/K382A	0.35	1.7	0.9	21	0.581
75	103	3000	4000	K387AS/K382A	0.35	1.7	0.9	21	0.573
94.5	138	3000	4000	K28682/K28622	0.4	1.49	0.82	21	0.74
119	160	3600	4600	K462A/K453X	0.34	1.79	0.98	24	1.06
119	160	3600	4600	K469/K453E	0.34	1.79	0.98	26	1.14
119	160	3600	4600	K469/K453X	0.34	1.79	0.98	26	1.07
92.5	125	3500	4400	K390/K3920	0.4	1.49	0.82	26	1.14
161	223	3200	4100	K555S/K552A	0.35	1.73	0.95	29	2.04
155	185	3000	4000	K78225C/K78551	0.87	0.69	0.38	45	2.53
206	240	3000	4000	KH913840/KH913810	0.78	0.77	0.42	45	3.28
206	240	3000	4000	KH913840/KH913810-3	0.78	0.77	0.42	45	3.28
145	168	3000	4000	KHM911244SH1/KHM911210SH1	0.82	0.73	0.4	44	2.11
115	170	3000	4000	K3977/K3920	0.4	1.49	0.82	25	1.30
137	175	3000	4000	KHM911244B/KHM911216B	0.82	0.73	0.4	41	2.06
135	188	3300	4100	K476/K472	0.38	1.56	0.86	26	1.54
150	194	3200	4000	KJW6049/KJW6010	0.82	0.73	0.4	42	2
95	75.5	3000	4000	K28985/K28921	0.43	1.41	0.77	24	0.812

Note: * indicates the maximum value of ID or OD.

Single-row Tapered Roller Bearing(Inch)

d 60.325~63.5 mm

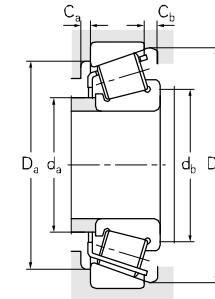
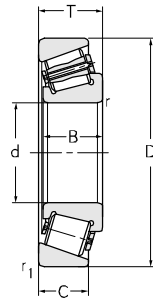
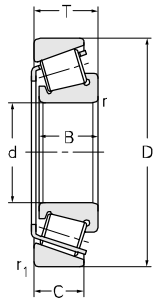

Principal dimensions											
d		D		T		B		C		r _{min}	R _{min}
mm	in	mm	in	mm	in	mm	in	mm	in	mm	
60.325		101.6	4	25.4	1	25.4	1	19.845	0.781	3.3	3.5
		122.238	4.813	38.1	1.5	38.354	1.51	29.718	1.17	3.3	8
		122.238	4.813	38.1	1.5	38.354	1.51	29.718	1.17	3.3	8
		122.238	4.813	43.658	1.719	43.764	1.723	36.512	1.437	3.3	3.5
		122.238	4.813	43.658	1.719	43.764	1.723	36.512	1.437	3.3	3.5
		123.825	4.875	38.1	1.5	36.678	1.444	30.162	1.187	3.3	2.3
		127	5	44.45	1.75	44.45	1.75	34.925	1.375	3.3	3.5
		136.525	5.375	46.038	1.813	46.038	1.813	36.512	1.437	3.3	3.5
61.912	2.437	112.712	4.437	26.967	1.062	21.996	0.866	23.812	0.937	3.3	0.8
		127	5	36.512	1.437	36.512	1.437	26.988	1.063	3.3	3.5
		136.525	5.375	46.038	1.813	46.038	1.813	36.512	1.437	3.3	3.5
63.5	2.5	94.458	3.719	19.05	0.75	19.05	0.75	15.083	0.594	1.5	1.5
		104.775	4.125	21.433	0.844	22	0.866	15.875	0.625	2.0	2.0
		107.95	4.25	25.4	1	25.4	1	19.05	0.75	0.8	3.5
		107.95	4.25	25.4	1	25.4	1	19.05	0.75	3.3	1.5
		107.95	4.25	25.4	1	25.4	1	19.05	0.75	0.8	1.5
		110	4.331	22	0.866	21.996	0.866	18.824	0.741	1.3	3.5
		110	4.331	25.4	1	25.4	1	19.05	0.75	1.3	3.5
		112.712	4.437	30.162	1.187	30.048	1.183	23.812	0.937	3.3	3.5
		112.712	4.437	30.162	1.187	30.162	1.187	23.812	0.937	3.3	3.5
		112.712	4.437	30.162	1.187	30.162	1.187	23.812	0.937	3.3	3.5
		122.238	4.813	38.1	1.5	38.354	1.51	29.718	1.17	1.5	7
		122.238	4.813	38.1	1.5	38.354	1.51	29.718	1.17	3.3	7
		123.825	4.875	38.1	1.5	36.678	1.444	30.162	1.187	3.3	3.5
		127	5	36.512	1.437	36.17	1.424	28.575	1.125	3.3	3.5
		127	5	36.512	1.437	36.512	1.437	26.988	1.063	3.3	3.5
		130.175	5.125	41.275	1.625	41.275	1.625	31.75	1.25	3.3	3.5

Basic load ratings		Limit speed ratings		Designations	Calculation coefficient				Weight
C _r	C _{0r}	Grease	Oil		e	Y	Y ₀	a	
kN		r/min							kg
95	75.7	3000	4000	K28985/K28920	0.43	1.41	0.77	24	0.851
233	154	3000	4000	KHM212044/KHM212011	0.34	1.78	0.98	31	2.08
233	154	3000	4000	KHM212044/KHM212011-3	0.34	1.78	0.98	31	2.08
220	315	3000	4000	K5583/K5535	0.36	1.67	0.92	31	2.39
220	315	3000	4000	K5583/K5535-2	0.36	1.67	0.92	31	2.39
162	223	3000	4000	K558/K552A	0.35	1.73	0.95	31	2.09
211	274	3000	4000	K65237/K65500	0.49	1.2	0.68	35	2.65
249	405	3000	4000	KH715332/KH715311	0.47	1.27	0.7	37	3.47
91	105	3000	4000	K392/K3920	0.4	1.49	0.82	27	1.06
166	234	2600	3400	KHM813843/KHM813810	0.5	1.2	0.66	37	2.16
249	405	2600	3400	KH715334/KH715311	0.47	1.3	0.7	37	3.41
62	105	3000	4000	KL610549/KL610510	0.42	1.4	0.78	20	0.453
92.5	119	3000	4000	K39250/K39412	0.39	1.6	0.86	20	0.711
92.5	141	3000	4000	K29585/K29522	0.46	1.31	0.72	24	0.914
92.5	141	3000	4000	K29586/K29520	0.46	1.31	0.72	18	0.914
92.5	141	3000	4000	K29586/K29522	0.46	1.31	0.72	24	0.914
90	117	3000	4000	K395/K394A	0.4	1.5	0.82	21	0.853
92.5	141	3000	4000	K29585/K29521	0.46	1.31	0.72	24	0.965
121	183	2900	3900	K3982/K3920	0.4	1.49	0.82	24	1.22
121	183	2900	3900	K39585/K39520	0.35	1.7	0.93	24	1.27
121	183	2900	3900	K39585/K39520/HE1	0.35	1.7	0.93	24	1.27
173	250	2900	3900	KHM212047/KHM212010	0.34	1.78	0.98	27	1.9
190	250	2900	3900	KHM212047/KHM212011	0.34	1.78	0.98	24	1.90
162	223	2900	3900	K559/K552A	0.35	1.73	0.95	29	1.99
163	237	2900	3900	K565/K563	0.36	1.65	0.91	29	2.09
166	234	2900	3900	KHM813842/KHM813810	0.5	1.2	0.66	32	2.12
199	271	2800	3800	K639/K633	0.36	1.66	0.91	30	2.52

Note: * indicates the maximum value of IDor OD.

Single-row Tapered Roller Bearing(Inch)

d 63.5-69.85 mm

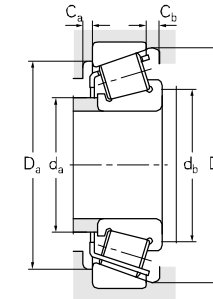
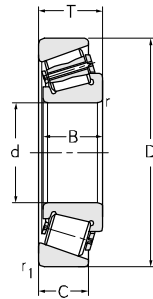
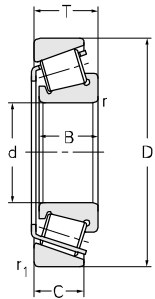

Principal dimensions											
d		D		T		B		C		r _{min}	R _{min}
mm	in	mm	in	mm	in	mm	in	mm	in	mm	
63.5		136.525	5.375	41.275	1.625	41.275	1.625	31.75	1.25	3.3	3.5
		136.525	5.375	41.275	1.625	41.275	1.625	31.75	1.25	3.3	3.5
65.088	2.563	135.755	5.345	53.975	2.125	56.007	2.205	44.45	1.75	3.3	3.5
66.675	2.625	107.95	4.25	25.4	1	25.4	1	19.05	0.75	0.8	3.5
		107.95	4.25	25.4	1	25.4	1	19.05	0.75	0.8	3.5
		110	4.331	22	0.866	21.996	0.866	18.824	0.741	1.3	0.8
		110	4.331	22	0.866	21.996	0.866	18.824	0.741	1.3	0.8
		110	4.331	22	0.866	21.996	0.866	18.824	0.741	1.3	3.5
		112.712	4.437	26.967	1.062	21.996	0.866	23.812	0.937	3.3	0.8
		112.712	4.437	30.162	1.187	30.162	1.187	23.812	0.937	3.3	3.5
		112.712	4.437	30.162	1.187	30.162	1.187	23.812	0.937	3.3	3.5
		117.475	4.625	30.162	1.187	30.162	1.187	23.812	0.937	3.3	3.5
		122.238	4.813	38.1	1.5	38.354	1.51	29.718	1.17	SP	SP
		122.238	4.813	38.1	1.5	38.354	1.51	29.718	1.17	1.5	3.5
		122.238	4.813	38.1	1.5	38.354	1.51	29.718	1.17	3.3	3.6
		122.238	4.813	38.1	1.5	38.354	1.51	29.718	1.17	3.3	3.5
		122.238	4.813	38.1	1.5	38.354	1.51	29.718	1.17	3.3	3.5
		122.238	4.813	38.1	1.5	38.354	1.51	29.718	1.17	3.3	3.5
		127	5	36.512	1.437	36.512	1.437	26.988	1.063	3.3	3.5
		136.525	5.375	41.275	1.625	41.275	1.625	31.75	1.25	3.3	3.5
		135.755	5.345	53.975	2.125	56.007	2.205	44.45	1.75	3.3	4.3
		136.525	5.375	46.038	1.813	46.038	1.813	36.512	1.437	3.3	3.5
		136.525	5.375	46.038	1.813	46.038	1.813	36.512	1.437	3.3	3.5
68.262	2.687	136.525	5.375	41.275	1.625	41.275	1.625	31.75	1.25	3.3	3.5
		136.525	5.375	41.275	1.625	41.275	1.625	31.75	1.25	3.3	3.5
		136.525	5.375	46.038	1.813	46.038	1.813	36.512	1.437	3.3	3.5
		161.925	6.375	49.212	1.937	46.038	1.813	31.75	1.25	3.3	3.5
69.85	2.75	112.712	4.437	25.4	1	25.4	1	19.05	0.75	3.3	1.5
		117.475	4.625	30.162	1.187	30.162	1.187	23.812	0.937	3.3	3.5

Basic load ratings		Limit speed ratings		Designations	Calculation coefficient				Weight
C _r	C _{Or}	Grease	Oil		e	Y	Yo	a	
kN		r/min							kg
264	340	2800	3800	KH414235A6/KH414210B2	0.36	1.66	0.91	30	2.96
264	340	2800	3800	KH414235/KH414210	0.36	1.66	0.91	30	3.03
280	400	2600	3400	K6379/K6320	0.32	1.88	1.02	36	3.63
92.5	141	2800	3800	K29590A6/K29522	0.46	1.31	0.72	24	0.853
92.5	141	2800	3800	K29590/K29522	0.46	1.31	0.72	18	0.853
90	117	2800	3800	K395A/K394A	0.4	1.49	0.82	21	0.797
90	117	2800	3800	K395A/K394A-3	0.4	1.49	0.82	21	0.797
90	117	2800	3800	K395S/K394A	0.4	1.49	0.82	21	0.397
90	117	2800	3800	K395A/K3920	0.4	1.49	0.82	26	0.981
121	183	2800	3800	K39590/K39520	0.35	1.7	0.93	24	1.23
141	201	2800	3800	K39590SH/K39520SH	0.35	1.7	0.93	24	1.23
123	180	2800	3800	K33262/K33462	0.44	1.38	0.76	28	1.37
233	154	2600	3400	KHM212049A6/KHM212010A6	0.34	1.78	0.98	27	1.90
233	154	2800	3800	KHM212049/KHM212010	0.34	1.78	0.98	27	1.90
233	154	2800	3800	KHM212049/KHM212011	0.34	1.78	0.98	24	1.90
233	154	2600	3400	KHM212049/KHM212011-3	0.34	1.78	0.98	27	1.90
190	250	2600	3400	KHM212049/KHM212011-HEND	0.34	1.78	0.98	27	1.91
190	250	2600	3400	KHM212049/KHM212011-NA	0.34	1.78	0.98	27	1.92
179	256	2800	3800	KHM813844/KHM813810	0.5	1.2	0.66	33	2.01
199	271	2600	3400	K641/K632	0.36	1.66	0.91	30	2.74
280	400	2600	3400	K6386/K6320	0.32	1.85	1.02	36	3.56
249	405	2600	3400	KH715341/KH715311	0.47	1.3	0.7	37	3.24
238	380	2600	3400	KH715341/KH715311-3	0.47	1.3	0.7	37	3.24
199	271	2600	3400	K642/K632	0.36	1.66	0.91	30	2.69
220	340	2600	3400	KH414245/KH414210	0.36	1.67	0.92	30	2.7
238	380	2600	3400	KH715343/KH715311	0.47	1.3	0.7	37	3.18
248	490	2800	3800	K9278/K9220	0.71	0.85	0.47	56	4.58
112	156	2600	3600	K29675/K29620	0.49	1.23	0.68	26	0.952
107	180	2600	3600	K33275/K33462	0.44	1.38	0.76	28	1.28

Note: * indicates the maximum value of IDor OD.

Single-row Tapered Roller Bearing(Inch)

d 69.85~75.987 mm

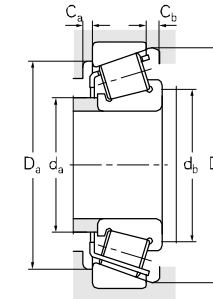
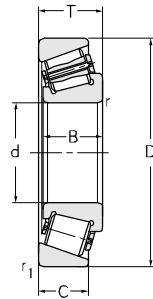
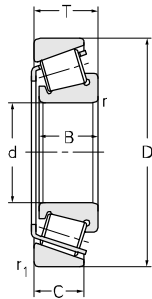

Principal dimensions												
d		D		T		B		C		r _{min}	R _{min}	
mm	in	mm	in	mm	in	mm	in	mm	in	mm		
69.85		120	4.724	32.545	1.281	32.545	1.281	26.195	1.031	3.3	3.5	
		120	4.724	29.795	1.173	29.007	1.142	24.237	0.954	2	3.5	
		127	5	36.512	1.437	36.17	1.424	28.575	1.125	3.3	3.5	
		130.175	5.125	41.275	1.625	41.275	1.625	31.75	1.25	3.3	3.5	
		146.05	5.75	41.275	1.625	39.688	1.563	25.4	1	3.3	3.6	
		146.05	5.75	41.275	1.625	39.688	1.563	25.4	1	3.3	3.5	
		146.05	5.75	41.275	1.625	39.688	1.563	25.4	1	3.3	3.5	
		149.225	5.875	41.275	1.625	41.275	1.625	31.75	1.25	3.3	3.5	
		150.089	5.909	44.45	1.75	46.672	1.837	36.512	1.437	3.3	3.5	
	70	2.756	130	5.118	43	1.693	42	1.654	35	1.378	2.5	7
	70*		110*		26	1.024	25	0.984	20.5	0.807	2.5	1
			120	4.7244	29.795	1.173	29.007	1.142	24.237	0.954	2	2
71.438	2.813	117.475	4.625	30.162	1.187	30.162	1.187	23.812	0.937	3.3	3.5	
		120	4.724	32.545	1.281	32.545	1.281	26.195	1.031	3.3	3.5	
		136.525	5.375	41.275	1.625	41.275	1.625	31.75	1.25	3.3	3.5	
		136.525	5.375	41.275	1.625	41.275	1.625	31.75	1.25	3.3	6.4	
73.025	2.875	112.712	4.437	25.4	1	25.4	1	19.05	0.75	3.3	3.5	
		117.475	4.625	30.162	1.187	30.162	1.187	23.812	0.937	3.3	3.5	
		127	5	36.512	1.437	36.17	1.424	28.575	1.125	3.3	3.5	
		139.992	5.511	36.512	1.437	36.098	1.421	28.575	1.125	3.3	3.5	
		150.089	5.909	44.45	1.75	46.672	1.837	36.512	1.437	3.3	3.5	
73.817	2.906	127	5	36.512	1.437	36.17	1.424	28.575	1.125	3.3	0.8	
75	2.953	145	5.709	51	2.008	51	2.008	42	1.654	2.5	3	
75*		115*		25	0.984	25	0.984	19	0.748	2.5	3	
		120*		31	1.22	29.5	1.161	25	0.984	2.5	3	
75.987	2.992	131.976	5.196	39	1.535	39	1.535	32	1.26	3.5	7	

Basic load ratings		Limit speed ratings		Designations	Calculation coefficient				Weight
C _r	C _{Or}	Grease	Oil		e	Y	Yo	a	
kN		r/min							kg
157	229	3000	4000	K47487/K47420	0.35	1.7	0.9	25	1.50
				K482/K472					
				K566/K563					
199	271	2600	3600	K643/K633	0.36	1.66	0.91	29	2.30
				KH913849A6/KH913810-2					
				KH913849/KH913810					
				KH913849/KH913810-3					
				K655/K652A					
215	315	2600	3600	K745A/K742	0.41	1.47	0.81	33	3.54
				K745A/K742					
225	325	2900	3700	KJF7049A/KJF7010	0.33	1.8	0.99	30	2.5
				KJF7049A/KJF7010					
102	156	3000	4000	KJLM813049/KJLM813010	0.49	1.23	0.68	26	0.894
				K484/K472					
				K484/K472					
121	190	2600	3600	K33281/K33462	0.44	1.38	0.76	28	1.24
				K47490/K47420					
				KH414249/KH414210					
				K645/K632					
112	156	2600	3600	K29685/K29620	0.49	1.23	0.68	25	0.878
				K33287/K33462					
				K567/K563					
				K576/K572					
				K744/K742					
				K744/K742					
172	255	2900	3700	K568/K563	0.36	1.65	0.91	29	1.78
				K568/K563					
303	435	2700	3400	KJH415647/KJH415610	0.36	1.66	0.91	37	3.89
				KJH415647/KJH415610					
105	152	2600	3600	KJLM714149/KJLM714110	0.46	1.3	0.72	25	8.58
				KJM714249/KJM714210					
128	204	2600	3600	KJM714249/KJM714210	0.44	1.35	0.74	28	1.28
				KJM714249/KJM714210					
203	305	2600	3600	KHM215249/KHM215210	0.33	1.84	1.01	28	2.14
				KHM215249/KHM215210					

Note: * indicates the maximum value of ID or OD.

Single-row Tapered Roller Bearing(Inch)

d 76.2-80.962 mm

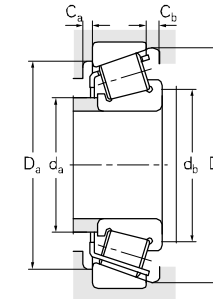
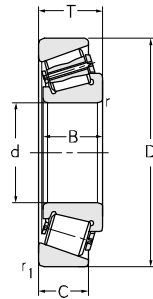
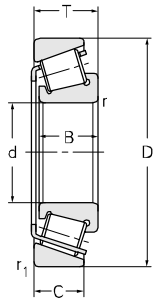

Principal dimensions												
d		D		T		B		C		r _{min}	R _{min}	
mm	in	mm	in	mm	in	mm	in	mm	in	mm		
76.2	3	125.412	4.937	25.4	1	25.4	1	19.845	0.781	1.5	3.5	
		127	5	30.162	1.187	31	1.22	22.225	0.875	3.3	3.5	
		127	5	30.162	1.187	31	1.22	22.225	0.875	3.3	6.4	
			133.35	5.25	33.338	1.313	33.338	1.313	26.195	1.031	3.3	3.5
			135.733	5.344	44.45	1.75	46.1	1.815	34.925	1.375	3.3	3.5
			136.525	5.375	30.162	1.187	29.769	1.172	22.225	0.875	3.175	3.5
			139.992	5.511	36.512	1.437	36.098	1.421	28.575	1.125	3.302	3.5
			139.992	5.511	36.512	1.437	36.098	1.421	28.575	1.125	3.5	3.5
			150.089	5.909	44.45	1.75	46.672	1.837	36.512	1.437	3.3	3.5
			150.089	5.909	44.45	1.75	46.672	1.837	36.512	1.437	3.3	3.5
			161.925	6.375	47.625	1.875	48.26	1.9	38.1	1.5	3.3	3.5
			161.925	6.375	53.975	2.125	55.1	2.169	42.862	1.687	3.3	3.5
		171.45	6.75	49.212	1.937	46.038	1.813	31.75	1.25	3.3	3.6	
		171.45	6.75	49.212	1.937	46.038	1.813	31.75	1.25	3.3	3.5	
		171.45	6.75	49.212	1.937	46.038	1.813	31.75	1.25	3.3	3.5	
		171.45	6.75	49.212	1.937	46.038	1.813	31.75	1.25	3.3	3.5	
		180.975	7.125	53.975	2.125	53.183	2.094	35.72	1.406	3.3	3.5	
		180.975	7.125	53.975	2.125	53.183	2.094	35.72	1.406	3.3	3.5	
77.788	3.063	117.475	4.625	25.4	1	25.4	1	19.05	0.75	3.3	3.5	
		121.442	4.781	24.608	0.969	23.012	0.906	17.462	0.687	2	3.5	
		135.733	5.344	44.45	1.75	46.1	1.815	34.925	1.375	3.3	3.5	
77.8	3.063	288.925	11.375	63.5	2.5	63.5	2.5	47.625	1.875	3.3	7	
79.375	3.125	146.05	5.75	41.275	1.625	41.275	1.625	31.75	1.25	3.3	3.5	
80*	130*	35	1.378	34	1.339	28.5	1.122	2.5	3			
		35	1.378	34	1.339	28.5	1.122	2.5	3			
80.962	3.187	136.525	5.375	30.162	1.187	29.769	1.172	22.225	0.875	3.175	3.503	
		150.089	5.909	44.45	1.75	46.672	1.837	36.512	1.437	3.3	5	

Basic load ratings		Limit speed ratings		Designations	Calculation coefficient				Weight						
C _r	C _{Or}	Grease	Oil		e	Y	Yo	a							
kN		r/min							kg						
91	160	2600	3600	K27684/K27620	0.45	1.32	0.73	29	1.25						
		2600	3600							K42687/K42620	0.42	1.43	0.79	27	1.44
		2600	3600							K42688/K42620	0.42	1.43	0.79	27	1.44
162	260	2400	3400	K47679/K47620	0.38	1.57	0.86	65	1.97						
		2600	3600							K5760/K5735	0.41	1.5	0.81	33	2.73
215	340	2600	3600	K495A/K493	0.44	1.35	0.74	29	1.82						
134	198	2400	3400												
187	290	2400	3400	K575/K572	0.4	1.49	0.82	32	2.44						
187	290	2400	3400							K575/K572A6	0.4	1.49	0.82	32	2.44
264	365	2400	3400	K748S/K742	0.33	1.84	1.01	33	3.62						
264	365	2400	3400							K748S/K742-3	0.33	1.84	1.01	33	3.62
273	390	2400	3400	K755/K752	0.34	1.76	0.97	40	4.85						
315	475	2400	3400							K6576/K6535	0.4	1.49	0.82	41	5.46
282	350	2000	2800	K9380A6/K9321-2	0.76	0.79	0.43	55	5.17						
267	325	2000	2800							K9380/K9321	0.76	0.79	0.43	54	5.20
282	350	2000	2800	K9380/K9321-3	0.76	0.79	0.43	54	5.20						
282	350	2000	2800							K9380/K9321/YB4	0.76	0.79	0.43	54	5.17
207	210	2000	2800	KH917840/KH917810	0.73	0.82	0.45	63	6.56						
320	400	2000	2800							KH917840/KH917810/YA8-3	0.73	0.82	0.45	63	6.66
114	163	3000	3800	KLM814849/KLM814810	0.51	1.18	0.65	28	0.979						
84	131	3000	3700							K34306/K34478	0.45	1.33	0.73	26	0.934
215	340	2600	3600							K5795/K5735	0.41	1.5	0.81	33	2.73
575	1010	1600	2000	K94700/K94113	0.47	1.28	0.71	62	15.5						
225	320	2600	3300	K661/K653/YB4	0.41	1.47	0.81	33	3.01						
175	280	2400	3400	KJM515649/KJM515610	0.41	1.48	0.81	30	1.82						
175	280	2400	3400							KJM515649/KJM515610-BZ	0.41	1.48	0.81	30	1.82
134	198	2400	3400	K496/K493	0.44	1.35	0.74	29	1.75						
270	365	2500	3200							K740/K742	0.33	1.84	1.01	32	3.31

Note: * indicates the maximum value of ID or OD.

Single-row Tapered Roller Bearing(Inch)

d 82.55~85.725 mm

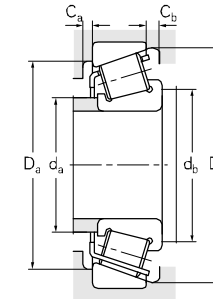
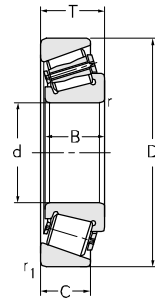
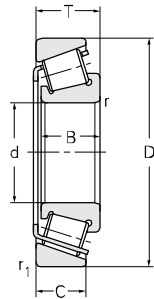

Principal dimensions											
d		D		T		B		C		r _{min}	R _{min}
mm	in	mm	in	mm	in	mm	in	mm	in	mm	
82.55	3.25	125.412	4.937	25.4	1	25.4	1	19.845	0.781	1.5	3.5
		125.412	4.937	25.4	1	25.4	1	19.845	0.781	1.5	3.5
	133.35	5.25	33.338	1.313	33.338	1.313	26.195	1.031	3.3	3.5	
	133.35	5.25	33.338	1.313	33.338	1.313	26.195	1.031	3.3	6.8	
	133.35	5.25	39.688	1.563	39.688	1.563	32.545	1.281	3.3	3.5	
	139.7	5.5	36.512	1.437	36.098	1.421	28.575	1.125	3.3	3.556	
	139.992	5.511	36.512	1.437	36.098	1.421	28.575	1.125	3.302	3.556	
	139.992	5.511	36.512	1.437	36.098	1.421	28.575	1.125	3.556	3.556	
	139.992	5.511	36.512	1.437	36.098	1.421	28.575	1.125	3.3	6.8	
	146.05	5.75	41.275	1.625	41.275	1.625	31.75	1.25	3.505	0.254	
	146.05	5.75	41.275	1.625	41.275	1.625	31.75	1.25	3.3	3.5	
	150	5.906	44.45	1.75	46.672	1.837	36.512	1.437	3.3	3.5	
168.275	6.625	53.975	2.125	56.363	2.219	41.275	1.625	3.3	3.5		
180.975	7.125	53.975	2.125	53.183	2.094	35.72	1.406	3.3	3.3		
83.345	3.281	125.412	4.937	25.4	1	25.4	1	19.845	0.781	1.5	3.5
84.138	3.313	133.35	5.25	30.162	1.187	29.769	1.172	22.225	0.875	3.3	3.5
84.976	3.346	125.412	4.937	25.4	1	25.4	1	19.845	0.781	1.5	5
85.026	3.347	150.089	5.909	44.45	1.75	46.672	1.837	36.512	1.437	3.3	3.5
		150.089	5.909	44.45	1.75	46.672	1.837	36.512	1.437	3.3	3.5
		150.089	5.909	44.45	1.75	46.672	1.837	36.512	1.437	3.3	5
85.725	3.375	133.35	5.25	30.162	1.187	29.769	1.172	22.225	0.875	3.3	3.556
		136.525	5.375	30.163	1.188	29.769	1.172	22.225	0.875	3.175	3.556
		142.138	5.596	42.862	1.687	42.862	1.687	34.133	1.344	3	4.8
		146.05	5.75	41.275	1.625	41.275	1.625	31.75	1.25	3.175	6.4
146.05	5.75	41.275	1.625	41.275	1.625	31.75	1.25	3.3	3.5		
147.638	5.813	35.717	1.406	36.322	1.43	26.192	1.031	0.8	3.5		
152.4	6	39.688	1.563	36.322	1.43	30.162	1.187	3.175	3.5		

Basic load ratings		Limit speed ratings		Designations	Calculation coefficient				Weight
C _r	C _{Or}	Grease	Oil		e	Y	Yo	a	
kN		r/min							kg
109	177	2400	3400	K27687/K27620-AK K27687SH/K27620SH	0.45	1.32	0.73	27	1.06
115	151	2400	3400		0.45	1.32	0.73	27	1.1
142	218	2400	3400	K47686/K47620 K47687/K47620	0.4	1.48	0.82	28	1.80
142	218	2400	3400		0.4	1.48	0.82	28	1.74
186	310	2400	3400	KHM516449/KHM516410	0.4	1.48	0.82	32	2.12
187	290	2400	3400	K580/K572X K580/K572	0.4	1.48	0.82	31	2.21
217	275	2400	3400		0.4	1.49	0.82	31	2.21
217	275	2400	3400	K580/K572A6 K582/K572	0.4	1.49	0.82	31	
184	277	2400	3400		0.4	1.48	0.82	31	2.19
265	360	2400	3400	K663/K653 663/653	0.41	1.47	0.81	36	2.87
215	315	2400	3400		0.41	1.47	0.81	33	2.87
264	365	2400	3400	K749A/K742A	0.33	1.84	1.01	38	3.33
405	466	2300	2900	K842/K832	0.3	2	1.1	35	5.36
207	210	2000	3000	KH917849/KH917810	0.73	0.82	0.45	50	6.25
100	160	2400	3400	K27690/K27620	0.42	1.44	0.79	26	1.08
134	198	2400	3400	K498/K492A	0.44	1.35	0.74	29	1.47
100	160	2400	3400	K27695/K27620	0.45	1.32	0.73	31	1.01
264	365	2400	3400	K749/K742 K749/K742-3 K749S/K742	0.33	1.84	1.01	31	3.22
265	365	2200	3200		0.33	1.8	1	32	3.22
264	365	2400	3400		0.33	1.84	1.01	33	3.20
134	198	2200	3200	K497/K492A K497/K493 KHM617049/KHM617010	0.44	1.35	0.74	23	1.47
134	198	2400	3400		0.44	1.35	0.74	29	1.60
220	345	2200	3200		0.43	1.4	0.76	35	2.63
217	315	2200	3200	K665A/K653 K665/K653A6	0.41	1.47	0.81	33	2.74
217	315	2200	3200		0.4	1.5	0.8	33	2.74
197	310	2200	3200	K596/K592XE	0.44	1.36	0.75	33	2.46
315	167	2000	3400	K596/K592A	0.44	1.36	0.75	39	2.92

Note: * indicates the maximum value of IDor OD.

Single-row Tapered Roller Bearing(Inch)

d 88.9-95.25 mm

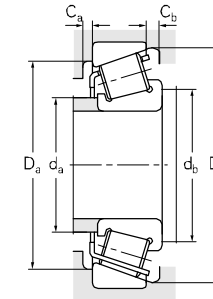
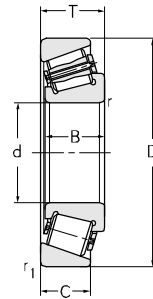
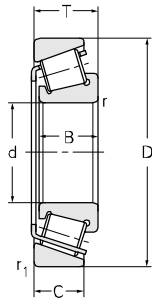

Principal dimensions											
d		D		T		B		C		r _{min}	R _{min}
mm	in	mm	in	mm	in	mm	in	mm	in	mm	
88.9	3.5	118.618	4.67	39.688	1.563	39.688	1.563	30.162	1.187	3.556	6.35
		152.4	6	39.688	1.563	39.688	1.563	30.162	1.187	SP	SP
		152.4	6	39.688	1.563	36.322	1.43	30.162	1.187	3.175	6.4
		152.4	6	39.688	1.563	36.322	1.43	30.162	1.187	3.3	3.5
		152.4	6	39.688	1.563	39.688	1.563	30.162	1.187	SP	SP
		161.925	6.375	47.625	1.875	48.26	1.9	38.1	1.5	3.3	3.5
		161.925	6.375	47.625	1.875	48.26	1.9	39.675	1.562	3.3	3.5
		161.925	6.375	53.975	2.125	55.1	2.169	42.862	1.687	3.3	3.5
		168.275	6.625	41.275	1.625	41.275	1.625	30.162	1.187	3.3	3.5
		190.5	7.5	57.15	2.25	57.531	2.265	44.45	1.75	3.3	8
		190.5	7.5	57.15	2.25	57.531	2.265	44.45	1.75	3.3	8
		190.5	7.5	57.15	2.25	57.531	2.265	46.038	1.813	3.3	8
89.975	3.542	146.975	5.786	40	1.575	40	1.575	32.5	1.28	3.5	7
90	3.543	147	5.787	40	1.575	40	1.575	32.5	1.28	3.5	5.8
90*		145*		35	1.378	34	1.339	27	1.063	2.5	6
		147*		40	1.575	40	1.575	32.5	1.28	SP	SP
		147*		40	1.575	40	1.575	32.5	1.28	3.5	7
		147*		40	1.575	40	1.575	32.5	1.28	5.8	3.5
92.075	3.625	146.05	5.75	33.338	1.313	34.925	1.375	26.195	1.031	3.3	3.5
		152.4	6	39.688	1.563	36.322	1.43	30.162	1.187	3.302	6.35
		152.4	6	39.688	1.563	36.322	1.43	30.162	1.187	3.3	3.5
		180.975	7.125	47.625	1.875	48.006	1.89	38.1	1.5	3.3	3.5
95	3.74	135	5.315	20	0.787	20	0.787	14	0.551	2.5	5
95*		150*		35	1.378	34	1.339	27	1.063	2.5	3
95.25	3.75	147.638	5.813	35.717	1.406	36.322	1.43	26.192	1.031	0.8	5
		152.4	6	39.688	1.563	36.322	1.43	30.162	1.187	3.302	5.08
		152.4	6	39.688	1.563	36.322	1.43	30.162	1.187	3.3	3.5
		152.4	6	39.688	1.563	36.322	1.43	30.162	1.187	3.3	8

Basic load ratings		Limit speed ratings		Designations	Calculation coefficient				Weight
C _r	C _{0r}	Grease	Oil		e	Y	Y ₀	a	
kN		r/min							kg
286	350	2000	3000	KHM518445/KHM518410	0.4	1.49	0.82	33	2.86
255	370	1800	2700	KHM518445/KHM518410-HEND	0.4	1.49	0.82	34	2.86
190	305	1800	2700	K593A/K592A	0.44	1.36	0.75	39	2.80
207	169	1800	2700	K593/K592A	0.44	1.36	0.75	39	2.63
255	370	1800	2700	KHM518445A6/KHM518410A6	0.4	1.49	0.82	34	2.86
375	390	2400	3400	K759/K752	0.34	1.76	0.97	35	4.26
305	410	2400	3400	K759/K752BX2	0.34	1.76	0.97	35	4.4
315	475	2400	3400	K6580/K6535	0.4	1.49	0.82	41	4.73
205	350	1800	2700	K679/K672	0.47	1.28	0.7	38	4.03
380	555	2400	3400	855/854B	0.33	1.79	0.99	40	7.71
380	555	1900	2600	K855/K854	0.33	1.8	0.99	42	7.69
445	610	1700	2400	KHH221434/KHH221410	0.33	1.79	0.99	24	7.87
229	345	2400	3100	KHM218248/KHM218210-HEND	0.33	1.8	0.99	31	2.51
230	370	2400	3100	KHM218248SH/KHM218210SH/YB2	0.33	1.8	0.99	31	2.57
189	315	2200	3200	KJM718149A/KJM718110	0.44	1.36	0.75	33	2.17
215	345	2200	3200	KHM218248A6/KHM218210A6	0.33	1.8	0.99	31	2.51
216	345	2200	3200	KHM218248/KHM218210	0.33	1.8	0.99	31	2.51
253	370	2200	3200	KHM218248SH/KHM218210SH	0.33	1.8	0.99	31	2.58
160	295	1900	2800	K47890/K47820	0.45	1.34	0.74	32	2.08
232	315	1900	2800	598A/592A	0.44	1.36	0.75	34	2.67
232	315	1900	2800	K598/K592A	0.44	1.36	0.75	34	2.66
288	435	1900	2800	K778/K772	0.39	1.56	0.86	44	5.55
86.5	151	1900	2800	KJL819349/KJL819310	0.58	1.04	0.57	31	0.82
187	290	1900	2800	KJM719149/KJM719113	0.44	1.4	0.75	33	2.23
228	310	1900	2800	594A/592XE	0.44	1.39	0.75	34	2.13
228	310	1900	2800	K594A/K592A	0.44	1.36	0.75	34	2.54
207	169	1900	2800	K594/K592A	0.44	1.36	0.75	34	2.54
207	169	1900	2800	K594R/K592A	0.44	1.36	0.75	34	2.52

Note: * indicates the maximum value of ID or OD.

Single-row Tapered Roller Bearing(Inch)

d 95.25~104.775 mm

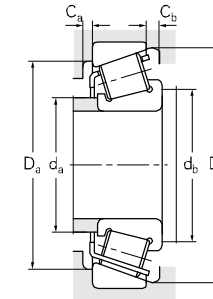
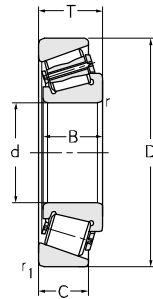
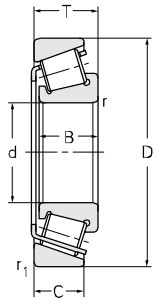

Principal dimensions											
d		D		T		B		C		r _{min}	R _{min}
mm	in	mm	in	mm	in	mm	in	mm	in	mm	
95.25		168.275	6.625	41.275	1.625	41.275	1.625	30.162	1.187	3.3	3.5
		190.5	7.5	57.15	2.25	57.531	2.265	46.038	1.813	3.3	8
96.838		3.813	148.43	5.844	28.575	1.125	28.971	1.141	21.433	0.844	3
			149.225	5.875	31.75	1.25	28.971	1.141	24.608	0.969	3.3
			188.912	7.437	50.8	2	46.038	1.813	31.75	1.25	3.3
			188.912	7.437	50.8	2	46.038	1.813	31.75	1.25	3.3
			188.912	7.437	50.8	2	46.038	1.813	31.75	1.25	3.3
99.974		3.936	156.975	6.18	42	1.654	42	1.654	34	1.339	3.5
99.975		3.936	212.725	8.375	66.675	2.625	66.675	2.625	53.975	2.125	3.3
101.6		4	136.525	5.375	21.433	0.844	21.433	0.844	16.67	0.656	1.5
			157.162	6.187	36.512	1.437	36.116	1.422	26.195	1.031	3.3
			168.275	6.625	41.275	1.625	41.275	1.625	30.162	1.187	3.3
			180.975	7.125	47.625	1.875	48.006	1.89	38.1	1.5	3.3
			190.5	7.5	57.15	2.25	57.531	2.265	44.45	1.75	3.3
			190.5	7.5	57.15	2.25	57.531	2.265	44.45	1.75	3.3
			190.5	7.5	57.15	2.25	57.531	2.265	44.45	1.75	3.3
			190.5	7.5	57.15	2.25	57.531	2.265	46.038	1.813	3.3
			190.5	7.5	57.15	2.25	57.531	2.265	46.038	1.813	3.3
			212.725	8.375	66.675	2.625	66.675	2.625	53.975	2.125	3.3
			212.725	8.375	66.675	2.625	66.675	2.625	53.975	2.125	3.3
			212.725	8.375	66.675	2.625	66.675	2.625	53.975	2.125	3.3
			212.725	8.375	66.675	2.625	66.675	2.625	53.975	2.125	3.3
			212.725	8.375	66.675	2.625	66.675	2.625	53.975	2.125	3.3
			214.312	8.437	55.562	2.187	52.388	2.063	39.688	1.563	3.3
			250.825	9.875	76.2	3	73.025	2.875	50.8	2	6.4
			250.825	9.875	76.2	3	73.025	2.875	50.8	2	6.4
104.775		4.125	180.975	7.125	47.625	1.875	48.006	1.89	38.1	1.5	3.3
			180.975	7.125	47.625	1.875	48.006	1.89	38.1	1.5	3.3
			180.975	7.125	47.625	1.875	48.006	1.89	38.1	1.5	3.3

Basic load ratings		Limit speed ratings		Designations	Calculation coefficient				Weight
C _r	C _{0r}	Grease	Oil		e	Y	Yo	a	
kN		r/min							kg
228	365	1900	2800	K683/K672	0.48	1.25	0.7	38	3.75
465	610	1800	2700	KHH221440/KHH221410	0.33	1.79	0.99	42	7.5
146	230	1900	2800	K42381/K42584	0.49	1.22	0.67	32	1.68
145	230	1900	2800	K42381/K42587B-3	0.49	1.22	0.67	36	1.89
270	345	1900	2800	K90381/K90744	0.87	0.69	0.38	62	5.63
270	345	1900	2800	K90381/K90744-3	0.87	0.69	0.38	62	5.63
278	360	1900	2800	K90381/K90744/YA8-3	0.87	0.69	0.38	62	5.72
253	400	1900	2800	KHM220149/KHM220110	0.33	1.84	1.01	42	2.89
600	830	1900	2800	KHH224334/KHH224310	0.33	1.84	1.01	54	11.2
90	165	2200	3000	KL420449/KL420410	0.37	1.63	0.9	24	0.846
193	315	2000	2800	K52400/K52618	0.47	1.3	0.69	36	2.48
228	365	2000	2800	K687/K672	0.47	1.28	0.7	38	3.43
290	435	2000	2600	K780/K772	0.39	1.6	0.83	39	5.00
380	555	1900	2600	K861/K854	0.33	1.8	0.99	42	6.80
380	555	1900	2600	K861/K854-2	0.33	1.8	0.99	42	6.80
380	555	1900	2600	K861/K854-3	0.33	1.8	0.99	42	6.80
445	610	1800	2600	KHH221449/KHH221410	0.33	1.79	0.99	24	7.87
465	645	1800	2600	KHH221449/KHH221410-3	0.33	1.79	0.99	24	7.87
655	900	1800	2600	KHH224335/KHH224310	0.33	1.84	1.01	48	11.1
655	900	1800	2600	KHH224335/KHH224310-3	0.33	1.84	1.01	48	11.1
450	675	1800	2600	K941/K932	0.33	1.84	1.01	48	11.0
450	675	1800	2600	K941/K932-3	0.33	1.84	1.01	48	11.1
595	900	1700	2200	HH224335/HH224310-DG	0.33	1.84	1.01	47	11.1
375	590	1800	2600	KH924033/KH924010	0.67	0.89	0.49	62	9.15
550	695	1400	1900	KHH923649/KHH923610	0.71	0.85	0.47	74	17.6
550	695	1400	1900	KHH923649/KHH923611	0.71	0.85	0.47	74	17.6
288	435	2000	2600	K782/K772	0.39	1.56	0.86	39	4.81
288	435	2000	2600	K786/K772	0.39	1.56	0.86	39	4.79
288	435	2000	2600	K787/K772	0.39	1.6	0.86	39	4.78

Note: * indicates the maximum value of IDor OD.

Single-row Tapered Roller Bearing(Inch)

d 107.95~120.65 mm

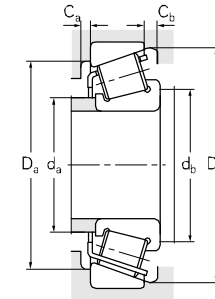
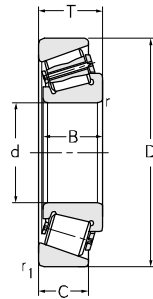
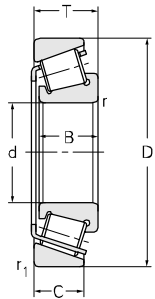

Principal dimensions											
d		D		T		B		C		r _{min}	R _{min}
mm	in	mm	in	mm	in	mm	in	mm	in	mm	
107.95	4.25	146.05	5.75	21.433	0.844	21.433	0.844	16.67	0.656	1.5	1.5
		158.75	6.25	23.02	0.906	21.438	0.844	15.875	0.625	3.3	3.5
		165.1	6.5	36.512	1.437	36.512	1.437	26.988	1.063	3.3	3.5
109.538	4.313	158.75	6.25	23.02	0.906	21.438	0.844	15.875	0.625	3.3	5
		158.75	6.25	23.02	0.906	21.438	0.844	15.875	0.625	3.3	3.5
100*		145*		24	0.945	22.5	0.886	17.5	0.689	5	3
		157*		42	1.654	42	1.654	34	1.339	SP	SP
110*		165*		35	1.378	35	1.378	26.5	1.043	2.5	3
		165*		35	1.378	35	1.378	26.5	1.043	3	2.5
		180*		47	1.85	46	1.811	38	1.496	2.5	3
		180*		47	1.85	46	1.811	38	1.496	2.5	3
		180	7.087	47	1.85	46	1.811	38	1.496	2.5	3
111.125	4.375	214.312	8.437	55.562	2.187	52.388	2.063	39.688	1.563	3.3	3.5
114.3	4.5	177.8	7	41.275	1.625	41.275	1.625	30.162	1.187	3.3	3.5
		190.5	7.5	47.625	1.875	49.212	1.937	34.925	1.375	3.3	3.5
		212.725	8.375	66.675	2.625	66.675	2.625	53.957	2.124	3.3	7
		228.6	9	53.975	2.125	49.428	1.946	38.1	1.5	3.3	3.5
114.976	4.527	180.975	7.125	41.275	1.625	41.275	1.625	30.162	1.187	3.3	9
117.8	4.638	247.65	9.75	47.625	1.875	47.625	1.875	38.1	1.5	3.3	10.5
120*		170*		27	1.063	25	0.984	19.5	0.768	3	3
120.65	4.75	174.625	6.875	35.72	1.406	36.512	1.437	27.783	1.094	1.5	3.5
		182.562	7.187	39.688	1.563	38.1	1.5	33.338	1.313	3.3	3.5
		206.375	8.125	47.625	1.875	47.625	1.875	34.925	1.375	3.3	3.3
		254	10	77.78	3.062	82.55	3.25	61.912	2.437	6.4	9.7
		273.05	10.75	82.55	3.25	82.55	3.25	53.975	2.125	6.4	6.4
		273.05	10.75	82.55	3.25	82.55	3.25	53.975	2.125	6.4	6.4

Basic load ratings		Limit speed ratings		Designations	Calculation coefficient				Weight
C _r	C _{Or}	Grease	Oil		e	Y	Yo	a	
kN		r/min							kg
106	180	1900	2800	KL521949/KL521910	0.39	1.54	0.85	26	0.993
107	174	1900	2800	K37425/K37625	0.61	0.99	0.54	39	1.36
198	330	1900	2800	K56425/K56650	0.5	1.2	0.7	38	2.67
107	174	1900	2800	K37431A/K37625	0.61	0.99	0.54	39	1.32
107	174	1900	2800	K37431/K37625	0.61	0.99	0.54	39	1.33
116	171	1900	2800	KJP10049A/KJP10010	0.47	1.27	0.7	30	1.13
253	400	1900	2800	KHM220149A6/KHM220110A6	0.33	1.8	0.99	33	2.89
195	320	1900	2800	KJM822049/KJM822010	0.5	1.21	0.66	39	2.63
211	360	1900	2800	KM822049/KM822010	0.5	1.2	0.66	38	2.63
320	510	1900	2800	KJHM522649/KJHM522610	0.41	1.48	0.81	40	4.56
320	510	1900	2800	KJHM522649/KJHM522610-2	0.41	1.48	0.81	40	4.56
320	510	1900	2800	KRJHM522649/JHM522610	0.41	1.48	0.81	40	4.56
375	590	1700	2300	H924045/H924010-DG	0.67	1.01	0.67	65	8.49
250	400	1900	2800	K64450/K64700	0.52	1.23	0.64	43	3.50
305	480	1900	2800	K71450/K71750	0.41	1.48	0.81	41	5.26
450	675	1700	2400	K938/K932	0.33	1.8	1	47	9.95
400	590	1500	2200	KHM926740/KHM926710-3	0.74	0.81	0.45	68	9.78
250	400	1900	2800	K64452A/K64713	0.52	1.15	0.63	43	3.72
420	520	1600	2300	K67791/K67720	0.44	1.36	0.75	52	6.82
155	243	1900	2800	KJP12049/KJP12010	0.47	1.3	0.69	35	1.75
210	365	1700	2400	KM224749/KM224710	0.33	1.8	0.99	32	2.66
228	430	1700	2400	K48282/K48220	0.3	2	1.1	34	3.56
330	550	1600	2200	K795/K792	0.46	1.3	0.72	46	6.28
730	1060	1500	2000	KHH228340/KHH228310-3	0.32	1.9	1	31	18.2
810	940	2200	3200	KHH926749/KHH926710	0.63	0.95	0.52	76	22.1
810	940	2200	3200	KHH926749/KHH926710-3	0.63	0.95	0.52	76	22.1

Note: * indicates the maximum value of ID or OD.

Single-row Tapered Roller Bearing(Inch)

d 123.825~146.05 mm

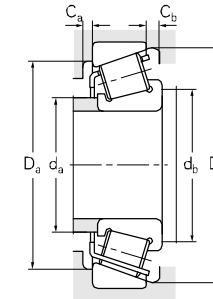
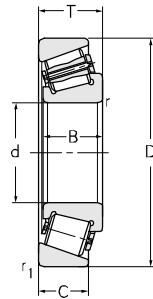
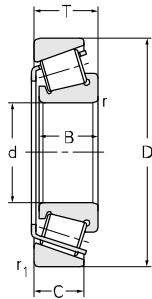

Principal dimensions											
d		D		T		B		C		r _{min}	R _{min}
mm	in	mm	in	mm	in	mm	in	mm	in	mm	
123.825	4.875	254	10	77.788	3.063	82.55	3.25	61.912	2.437	6.4	9.7
127	5	182.562	7.187	39.688	1.563	38.1	1.5	33.338	1.313	3.3	3.5
		182.562	7.187	39.688	1.563	38.1	1.5	33.338	1.313	3.3	3.5
		228.6	9	53.975	2.125	49.428	1.946	38.1	1.5	3.3	3.5
		228.6	9	53.975	2.125	49.428	1.946	38.1	1.5	3.3	3.5
		234.95	9.25	63.5	2.5	63.5	2.5	49.212	1.937	3.3	6.4
		254	10	77.788	3.063	82.55	3.25	61.912	2.437	6.4	9.7
		304.8	12	88.9	3.5	82.55	3.25	57.15	2.25	6.4	6.4
128.588	5.063	206.375	8.125	47.625	1.875	47.625	1.875	34.925	1.375	3.3	3.3
130.175	5.125	196.85	7.75	46.038	1.813	46.038	1.813	38.1	1.5	3.3	3.5
133.35	5.25	190.5	7.5	39.688	1.563	39.688	1.563	33.338	1.313	3.3	3.5
		196.85	7.75	46.038	1.813	46.038	1.813	38.1	1.5	3.3	3.5
		196.85	7.75	46.038	1.813	46.038	1.813	38.1	1.5	3.3	3.5
		234.95	9.25	63.5	2.5	63.5	2.5	49.212	1.937	3.3	9.7
		234.95	9.25	63.5	2.5	63.5	2.5	49.212	1.937	3.3	9.7
139.7	5.5	228.6	9	57.15	2.25	57.15	2.25	44.45	1.75	3.3	3.5
		236.538	9.313	57.15	2.25	56.642	2.23	44.45	1.75	3.3	3.5
		254	10	66.675	2.625	66.675	2.625	47.625	1.875	3.3	7
		295.275	11.625	82.55	3.25	87.312	3.437	57.15	2.25	6.4	9.7
142.875	5.625	200.025	7.875	41.275	1.625	39.688	1.563	34.13	1.344	3.3	7.9
		241.3	9.5	57.15	2.25	56.642	2.23	44.45	1.75	3.3	8
		241.3	9.5	57.15	2.25	56.642	2.23	44.45	1.75	3.3	8
146.05	5.75	193.675	7.625	28.575	1.125	28.575	1.125	23.02	0.906	1.5	1.5
		193.675	7.625	28.575	1.125	28.575	1.125	23.02	0.906	1.5	1.5
		236.538	9.313	57.15	2.25	56.642	2.23	44.45	1.75	3.3	3.5
		304.8	12	88.9	3.5	82.55	3.25	57.15	2.25	6.4	6.4
		304.8	12	88.9	3.5	82.55	3.25	57.15	2.25	6.4	6.4

Basic load ratings		Limit speed ratings		Designations	Calculation coefficient				Weight
C _r	C _{0r}	Grease	Oil		e	Y	Y ₀	a	
kN		r/min							kg
730	1060	1500	2000	KHH228344/KHH228310	0.32	1.87	1.03	54	18.6
240	430	1700	2400	48290/48220	0.3	2	1.1	34	3.20
228	430	1700	2400	K48290/K48220	0.3	2	1.1	34	3.20
400	590	1700	2400	KHM926747/KHM926710	0.74	0.81	0.45	68	8.88
400	590	1700	2400	KHM926747/KHM926710-3	0.74	0.81	0.45	68	8.88
515	810	1700	2400	K95500/K95925	0.37	1.62	0.89	51	11.6
730	1060	1500	2200	KHH228349/KHH228310	0.32	1.87	1.03	54	18.2
875	1210	1400	2000	KHH932132/KHH932110/YA8-3	0.73	0.82	0.45	93	27.7
330	550	1600	2200	K799/K792	0.46	1.3	0.72	46	5.70
330	590	1600	2200	67389/67322	0.34	1.74	0.96	40	4.96
247	455	1600	2200	K48385/K48320	0.32	1.88	1.04	35	3.52
330	590	1600	2200	67390/67322-BZ	0.35	1.7	0.9	39	4.71
330	590	1600	2200	67390/67322-BZ	0.35	1.7	0.9	39	4.71
515	810	1500	2000	95525/95925	0.37	1.62	0.89	51	11.1
515	810	1500	2000	K95525/K95925	0.37	1.62	0.89	51	11.1
370	680	1400	1900	K898/K892	0.42	1.43	0.79	50	8.85
510	810	1400	1900	KHM231132/KHM231110	0.31	1.9	1.1	45	10.1
715	1100	1400	1900	K99550/K99100	0.41	1.47	0.81	54	14.0
820	1100	1200	1700	KHH231649/KHH231615-2	0.32	1.88	1.04	55	24.7
250	515	1600	2000	K48684/K48620	0.34	1.78	0.98	37	3.88
420	730	1400	1800	82562A/82950-DANA	0.44	1.36	0.75	54	10.4
420	730	1400	1800	82562A/82950/HCOI-DANA	0.44	1.36	0.75	54	10.4
186	370	1600	2200	K36690/K36620B	0.37	1.6	0.9	34	2.22
186	370	1600	2200	K36690/K36620B	0.37	1.6	0.9	34	2.22
406	700	1300	1900	K82576/K82931	0.44	1.36	0.75	52	9.56
835	1140	1100	1600	KHH932145/KHH932110	0.73	0.82	0.45	105	28.3
875	1210	1100	1600	KHH932145/KHH932110/YA8	0.73	0.82	0.45	93	27.7

Note: * indicates the maximum value of IDor OD.

Single-row Tapered Roller Bearing(Inch)

d 152.4~180 mm

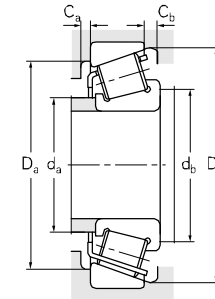
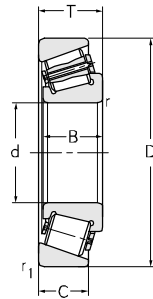
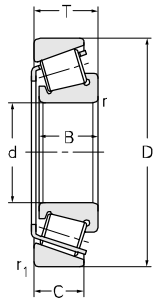

Principal dimensions											
d		D		T		B		C		r _{min}	R _{min}
mm	in	mm	in	mm	in	mm	in	mm	in	mm	
152.4	6	222.25	8.75	46.83	1.844	46.83	1.844	34.925	1.375	1.5	3.5
		222.25	8.75	46.83	1.844	46.83	1.844	34.925	1.375	1.5	3.5
		254	10	66.675	2.625	66.675	2.625	47.625	1.875	3.3	7
		268.288	10.563	74.612	2.937	74.612	2.937	57.15	2.25	6.4	6.4
		268.288	10.563	74.612	2.937	74.612	2.937	57.15	2.25	6.4	6.4
		307.975	12.125	88.9	3.5	93.662	3.687	66.675	2.625	6.8	9.7
155.575	6.125	330.2	13	85.725	3.375	79.375	3.125	53.975	2.125	6.4	6.4
158.75	6.25	225.425	8.875	41.275	1.625	39.688	1.563	33.338	1.313	3.3	3.5
165.1	6.5	225.425	8.875	41.275	1.625	39.688	1.563	33.338	1.313	3.3	3.5
		225.425	8.875	41.275	1.625	39.688	1.563	33.338	1.313	3.3	3.5
		247.65	9.75	47.625	1.875	47.625	1.875	38.1	1.5	3.3	3.5
		288.925	11.375	63.5	2.5	63.5	2.5	47.625	1.875	7	3.3
170*		240*		46	1.811	44.5	1.752	37	1.457	2.5	3
171.45	6.75	260.35	10.25	66.675	2.625	66.675	2.625	52.388	2.063	3.3	3.5
174.625	6.875	288.925	11.375	63.5	2.5	63.5	2.5	47.625	1.875	3.3	7
		288.925	11.375	63.5	2.5	63.5	2.5	47.625	1.875	3.3	7
177.8	7	227.012	8.937	30.162	1.187	30.162	1.187	23.02	0.906	1.5	1.5
		247.65	9.75	47.625	1.875	47.625	1.875	38.1	1.5	3.3	3.5
		260.35	10.25	53.975	2.125	53.975	2.125	41.275	1.625	3.3	3.5
		260.35	10.25	53.975	2.125	53.975	2.125	41.275	1.625	3.3	3.5
		260.35	10.25	53.975	2.125	53.975	2.125	41.275	1.625	3.3	3.5
		260.35	10.25	53.975	2.125	53.975	2.125	41.275	1.625	3.3	3.5
		288.925	11.375	63.5	2.5	63.5	2.5	47.625	1.875	3.3	7
		319.964	12.597	88.9	3.5	85.725	3.375	65.088	2.563	4.8	3.5
428.628	16.875	106.362	4.187	95.25	3.75	61.912	2.437	6.4	6.4		
180*		250*		47	1.85	45	1.772	37	1.457	3	2.5
		250	9.843	47	1.85	45	1.772	37	1.457	3	2.5

Basic load ratings		Limit speed ratings		Designations	Calculation coefficient				Weight
C _r	C _{0r}	Grease	Oil		e	Y	Y ₀	a	
kN		r/min							kg
368	630	1100	1600	KM231649/KM231610	0.33	1.8	0.99	28	5.76
368	630	1100	1600	M231649/M231610	0.33	1.8	0.99	41	5.76
595	930	1100	1600	K99600/K99100	0.41	1.5	0.81	55	12.5
670	1070	1200	1700	EE107060/107105	0.39	1.55	0.85	58	16.8
670	1070	1200	1700	KEE107060/K107105	0.39	1.55	0.85	58	16.8
1190	1350	1100	1600	KHH234048/KHH234010	0.33	1.84	1.01	63	30.9
825	1140	1100	1600	KH936340/KH936310	0.81	0.74	0.41	106	31.6
261	440	1100	1600	K46780/K46720	0.38	1.57	0.86	44	5.24
260	565	1100	1600	46790/46720	0.38	1.57	0.86	43	4.64
261	565	1100	1600	K46790/K46720	0.38	1.57	0.86	44	4.64
415	520	1000	1400	K67780/K67720	0.44	1.36	0.75	52	8.16
625	670	1100	1600	KHM237535/KHM237510	0.32	1.88	1.04	52	16.8
355	675	1000	1400	JM734449/JM734410	0.44	1.37	0.75	49	6.28
550	1070	1000	1400	KHM535349/KHM535310	0.4	1.6	0.83	64	12.3
570	670	1000	1400	HM237542/HM237510	0.32	1.88	1.04	53	15.6
815	850	1000	1400	KHM237542/KHM237510	0.33	1.84	1.01	54	16.9
180	410	1000	1400	K36990/K36920	0.44	1.36	0.75	43	3.06
415	520	1000	1400	K67790/K67720	0.44	1.36	0.75	52	7.12
430	840	1000	1400	KM236849/KM236810	0.33	1.8	0.99	47	9.08
450	830	1000	1400	KM236849/KM236810/YAD-3	0.33	1.8	0.99	47	9.24
430	840	1000	1400	M236849/M236810	0.33	1.8	0.99	47	9.08
815	850	900	1300	KHM237545/KHM237510	0.33	1.84	1.01	54	16.7
930	1420	1000	1400	KH239640/KH239610	0.32	1.88	1.04	65	28.2
1320	1840	900	1000	KEE350701/K351687	0.76	0.82	0.43	121	68.1
400	780	900	1000	JM736149/JM736110	0.48	1.25	0.69	56	6.80
365	780	900	1000	JM736149/JM736110-BZ	0.48	1.25	0.69	56	6.80

Note: * indicates the maximum value of ID or OD.

Single-row Tapered Roller Bearing(Inch)

d 184.15~220.662 mm

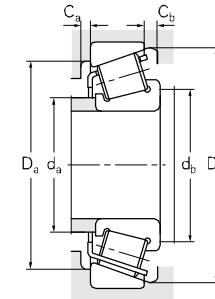
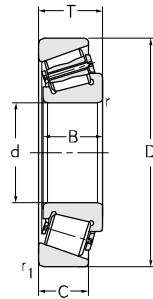
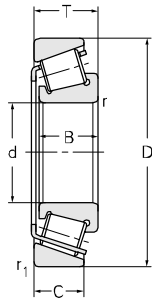

Principal dimensions											
d	D	T	B	C	r _{min}	R _{min}					
mm	in	mm	in	mm	in	mm	in	mm	in	mm	
184.15	7.25	280	11.024	46.525	1.832	46.833	1.844	36	1.417	3.3	3.5
187.325	7.375	269.875	10.625	55.562	2.187	55.562	2.187	42.862	1.687	3.3	3.5
		320.675	12.625	88.9	3.5	85.725	3.375	65.088	2.563	4.8	5.5
190.5	7.5	266.7	10.5	47.625	1.875	46.833	1.844	38.1	1.5	3.3	3.5
		336.55	13.25	98.425	3.875	95.25	3.75	73.025	2.875	6.4	6.4
		365.049	14.372	92.075	3.625	88.897	3.5	63.5	2.5	3.3	6.4
		428.625	16.875	106.362	4.187	95.25	3.75	61.912	2.437	6.4	6.4
196.85	7.75	241.3	9.5	23.812	0.937	23.017	0.906	17.462	0.687	1.5	1.5
		241.3	9.5	23.812	0.937	23.017	0.906	17.462	0.687	1.5	1.5
		254	10	28.575	1.125	27.783	1.094	21.433	0.844	1.5	1.5
		254	10	28.575	1.125	27.783	1.094	21.433	0.844	1.5	1.5
		257.175	10.125	39.688	1.563	39.688	1.563	30.162	1.187	3.3	3.5
		266.7	10.5	39.688	1.563	39.688	1.563	30.162	1.187	3.3	3.5
		317.5	12.5	63.5	2.5	63.5	2.5	46.038	1.813	3.3	4.3
198.5	7.815	257.175	10.125	39.688	1.563	39.688	1.563	30.162	1.187	3.3	3.5
200*	300*		65	2.559	62	2.441	51	2.008	2.5	3.5	
200.025	7.875	393.7	15.5	111.125	4.375	111.125	4.375	84.138	3.313	6.4	6.4
203.2	8	292.1	11.5	57.945	2.281	57.945	2.281	46.038	1.813	3.3	3.5
209.55	8.25	317.5	12.5	63.5	2.5	63.5	2.5	46.038	1.813	3.3	4.3
		317.5	12.5	63.5	2.5	63.5	2.5	46.038	1.813	3.3	4.3
215.9	8.5	285.75	11.25	46.038	1.813	46.038	1.813	34.925	1.375	3.3	3.6
219.969	8.66	290.01	11.418	31.75	1.25	31.75	1.25	22.225	0.875	3.3	3.5
220.662	8.687	314.325	12.375	61.912	2.437	61.912	2.437	49.212	1.937	3.3	6.4

Basic load ratings		Limit speed ratings		Designations	Calculation coefficient				Weight
C _r	C _{0r}	Grease	Oil		e	Y	Y ₀	a	
kN			r/min					kg	
360	760	900	1000	K67883/K67830	0.48	1.26	0.69	58	10.1
425	860	900	1000	KM238849/KM238810	0.33	1.81	1	49	9.63
930	1420	800	900	KH239649/KH239612	0.32	2.11	2.06	56	26.7
345	725	1100	1500	K67885/K67820	0.48	1.3	0.69	58	8.04
965	1720	1000	1200	KHH840249/KHH840210	0.58	1.04	0.57	93	35.8
990	1460	900	1000	KEE420751/K421437	0.4	1.6	0.83	79	39.3
1440	1840	800	900	EE350750/351687/YB2	0.76	0.79	0.44	121	64.6
160	330	1200	1700	KLL639249/KLL639210	0.43	1.4	0.8	41	2.10
160	330	1200	1700	KLL639249/KLL639210/P6XYB2	0.43	1.4	0.8	42	2.1
251	460	1100	1600	L540049/L540010/HCOIP6X	0.4	1.51	0.83	43	3.48
251	460	1100	1600	L540049/L540010/P6X	0.4	1.51	0.83	43	3.48
275	635	1100	1600	KLM739749/KLM739710	0.44	1.35	0.8	50	5.20
275	635	1100	1600	KLM739749/KLM739719	0.44	1.35	0.8	50	6.14
605	1130	850	1200	K93775/K93125	0.52	1.15	0.63	73	18.8
275	635	1100	1600	JKLM739749AX/JKLM739710	0.45	1.34	0.74	51	5.08
615	1240	850	1200	JHM840449/JHM840410	0.52	1.15	0.63	72	15.5
1470	2300	800	1000	KHH144642/KHH144614-3	0.3	2	1.1	77	59
525	1060	850	1200	KM241547/KM241510	0.33	1.8	0.99	53	12.6
605	1130	850	1200	93825/93125	0.52	1.15	0.63	73	16.6
605	1130	850	1200	K93825/K93125	0.52	1.15	0.63	73	16.6
370	780	850	1200	KLM742749/KLM742710-WTL	0.48	1.25	0.69	61	7.66
261	495	850	1200	K543086/K543114	0.39	1.55	0.85	47	5.08
620	1220	1000	1500	KM244249/KM244210	0.33	1.88	0.99	58	14.9

Note: * indicates the maximum value of ID or OD.

Single-row Tapered Roller Bearing(Inch)

d 228.397~260.35 mm

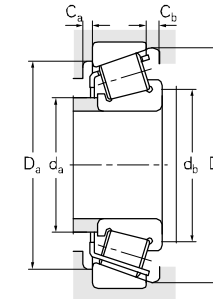
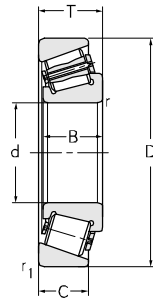
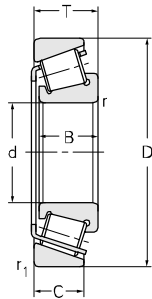

Principal dimensions											
d	D		T		B		C		r _{min}	R _{min}	
mm	in	mm	in	mm	in	mm	in	mm	in	mm	
228.397	8.992	431.8	17	92.075	3.625	85.725	3.375	49.212	1.937	6.4	6.4
228.6	9	355.6	14	69.85	2.75	69.85	2.75	49.212	1.937	1.5	6.8
		355.6	14	68.262	2.687	66.675	2.625	47.625	1.875	3.3	7
		358.775	14.125	71.438	2.813	71.438	2.813	53.975	2.125	3.3	3.5
		488.95	19.25	123.825	4.875	111.125	4.375	73.025	2.875	6.4	6.4
488.95	19.25	123.825	4.875	111.125	4.375	73.025	2.875	6.4	6.4		
231.775	9.125	336.55	13.25	65.088	2.563	65.088	2.563	50.8	2	3.3	6.4
234.95	9.25	314.325	12.375	49.212	1.937	49.212	1.937	36.512	1.437	3.3	3.5
		384.175	15.125	112.712	4.437	112.712	4.437	90.488	3.563	6.4	6.4
237.33	9.344	336.55	13.25	65.088	2.563	65.088	2.563	50.8	2	3.3	6.4
241.3	9.5	327.025	12.875	52.388	2.063	52.388	2.063	36.512	1.437	3.3	6.4
		444.5	17.5	101.6	4	100.012	3.937	76.2	3	4.8	6.4
247.65	9.75	304.8	12	22.225	0.875	22.225	0.875	15.875	0.625	1.5	1.5
		406.4	16	115.888	4.563	117.475	4.625	93.662	3.687	6.4	6.4
254	10	324.975	12.794	39	1.535	41.5	1.634	28	1.102	3.3	1.5
		324.975	12.794	39	1.535	41.5	1.634	28	1.102	3.3	1.5
254*		324.975*	39	1.535	41.5	1.634	28	1.102	3.3	1.5	1.5
		533.4	21	133.35	5.25	120.65	4.75	77.788	3.063	6.4	6.4
255.6	10.063	342.9	13.5	57.15	2.25	63.5	2.5	44.45	1.75	3.3	1.5
		342.9	13.5	57.15	2.25	63.5	2.5	44.45	1.75	3.3	1.5
257.175	10.125	342.9	13.5	57.15	2.25	57.15	2.25	44.45	1.75	3.3	6.4
		358.775	14.125	71.438	2.813	76.2	3	53.975	2.125	3.3	1.5
		358.775	14.125	71.438	2.813	76.2	3	53.975	2.125	3.3	1.5
		358.775	14.125	71.438	2.813	76.2	3	53.975	2.125	3.3	1.5
260.35	10.25	422.275	16.625	86.121	3.391	79.771	3.141	66.675	2.625	3.3	6.8

Basic load ratings		Limit speed ratings		Designations	Calculation coefficient				Weight
C _r	C _{0r}	Grease	Oil		e	Y	Y ₀	a	
kN		r/min							kg
1080	1600	850	1150	KEE113089/K113170	0.88	0.77	0.75	116	51.9
840	1280	850	1150	EE130902/131400	0.33	1.82	1	60	23.5
650	1290	950	1300	K96900/K96140-3	0.59	1.02	0.56	86	23.8
750	1500	950	1300	KM249732/KM249710-1	0.33	1.8	0.99	65	27.2
1820	2490	750	1000	HH949549/HH949510	0.94	0.64	0.35	174	101
1800	2400	750	1000	HH949549/HH949510/YAD-3	0.94	0.64	0.35	174	102
640	1360	850	1200	KM246942/KM246910	0.33	1.8	0.99	61	18.5
485	980	850	1200	LM545849/LM545810/HCOI	0.4	1.51	0.83	57	10
1360	2540	750	1000	KH247549/KH247510	0.33	1.88	0.99	84	50.0
640	1360	850	1200	KM246949/KM246910	0.33	1.8	0.99	61	17.5
470	950	900	1200	K8578/K8520	0.41	1.5	0.81	60	11.3
1340	2000	750	1000	KEE923095/K923175	0.34	1.78	0.98	83	65.9
155	370	750	1000	K28880YB2/K28820YB2	0.32	1.87	1.03	39	3.29
1690	3200	750	1000	HH249949/HH249910	0.33	1.8	0.99	87	58.0
315	800	850	1200	1-7009	0.56	1.07	0.59	71	8.06
315	800	850	1200	JL848849/JL848811/YB2	0.56	1.07	0.59	71	8.06
365	800	850	1200	L848849SH/L848810SH	0.56	1.07	0.59	71	8.06
365	800	850	1200	HH953749/HH953710	0.94	0.64	0.35	179	129
582	1220	850	1200	KM349547/KM349510	0.35	1.73	0.95	59	16.1
582	1220	850	1200	M349547SH/M349510SH	0.35	1.73	0.95	59	14.4
725	880	850	1200	KM349549/KM349510	0.35	1.73	0.95	80	14.0
825	1760	850	1200	KM249747/KM249710	0.33	1.8	0.99	64	21.7
825	1760	850	1200	M249747/M249710/YAD	0.33	1.8	0.99	64	21.7
1100	1800	900	1300	HM252348/HM252310	0.33	1.8	0.99	78	42.8

Note: * indicates the maximum value of ID or OD.

Single-row Tapered Roller Bearing(Inch)

d 266.7~406.4 mm

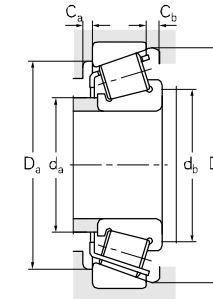
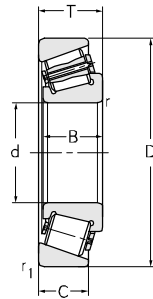
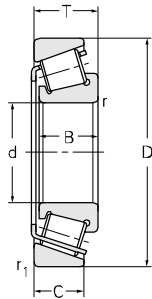

Principal dimensions											
d		D		T		B		C		r _{min}	R _{min}
mm	in	mm	in	mm	in	mm	in	mm	in	mm	
266.7	10.5	325.438	12.813	28.575	1.125	28.575	1.125	25.4	1	1.5	1.5
		355.6	14	57.15	2.25	57.15	2.25	44.45	1.75	3.3	3.5
		444.5	17.5	120.65	4.75	117.475	4.625	88.9	3.5	6.4	6.4
274.574	10.81	406.413	16.001	76.2	3	76.2	3	60.325	2.375	4.3	3
		457.2	18	76.556	3.014	76.2	3	57.15	2.25	4.3	3
288.925	11.375	406.4	16	77.788	3.063	77.788	3.063	60.325	2.375	3.3	6.4
		406.4	16	77.788	3.063	77.788	3.063	60.325	2.375	3.3	6.4
304.8	12	393.7	15.5	50.8	2	50.8	2	38.1	1.5	3.3	6.4
		406.4	16	63.5	2.5	63.5	2.5	47.625	1.875	3.3	6.4
		495.3	19.5	95.25	3.75	92.075	3.625	69.85	2.75	6.4	16
317.5	12.5	447.675	17.625	85.725	3.375	85.725	3.375	68.262	2.687	3.3	3.5
330.2	13	415.925	16.375	47.625	1.875	47.625	1.875	34.925	1.375	3.3	3.5
342.9	13.5	450.85	17.75	66.673	2.625	66.675	2.625	52.388	2.063	3.5	8.5
371.5	14.626	622.3	24.5	147.6385	5.813	131.762	5.187	82.55	3.25	12.7	14.3
377.825	14.875	522.288	20.563	85.725	3.375	84.138	3.313	61.912	2.437	3.3	6.4
381	15	522.288	20.563	85.725	3.375	84.138	3.313	61.912	2.437	3.3	6.4
		546.1	21.5	104.7754	4.125	104.775	4.125	82.55	3.25	6.4	6.4
384.175	15.125	546.100	21.5	104.7754	4.125	104.775	4.125	82.550	3.25	6.4	6.4
385.762	15.187	514.35	20.25	82.55	3.25	82.55	3.25	63.5	2.5	3.3	6.4
396.875	15.625	546.1	21.5	76.2	3	61.12	2.406	55.562	2.187	6.4	6.4
406.4	16	508	20	61.912	2.437	61.912	2.437	47.625	1.875	3.3	3.3
		546.1	21.5	76.2	3	61.12	2.406	55.562	2.187	6.4	6.4

Basic load ratings		Limit speed ratings		Designations	Calculation coefficient				Weight
C _r	C _{0r}	Grease	Oil		e	Y	Y ₀	a	
kN		r/min							kg
207	501	850	1200	K38885/K38820	0.37	1.64	0.9	48	4.78
715	800	850	1200	KLM451349/KLM451310	0.36	1.67	0.92	62	15.1
1610	3050	670	900	KH852849/KH852810	0.58	1.04	0.57	121	73.1
1000	1790	670	900	306/274X4-1	0.37	1.62	0.89		31.8
1170	1880	670	900	306/274X4					46.5
1250	1900	670	900	M255449/M255410	0.34	1.78	0.98	72	30.5
1000	2050	670	900	M255449/M255410/HE	0.34	1.78	0.98	72	30.7
580	1210	670	900	KL357049/KL357010	0.36	1.68	0.92	64	14.6
740	1580	600	750	KLM757049/KLM757010	0.44	1.38	0.76	79	21.2
1330	2480	500	700	EE724120/724195	0.4	1.49	0.82	97	67.1
960	2330	670	900	HM259048/HM259010	0.33	1.8	0.99	80	41.3
475	1140	670	900	KL860049/KL860010	0.5	1.2	0.7	83	14.3
770	1750	630	850	KLM361649/KLM361610	0.33	1.8	1	78	26.5
2300	3600	420	580	H961649/H961610	0.94	0.64	0.35	210	180
1170	2580	670	900	KLM565946/KLM565910	0.38	1.56	0.86	93	51.9
1170	2580	650	870	KLM565949/KLM565910	0.38	1.56	0.86	93	51.2
1860	4100	560	750	KHM266446/KHM266410	0.33	1.8	1	96	77.7
1850	4150	530	700	HM266449/HM266410	0.33	1.8	1	96	77.6
1420	2790	630	850	LM665949/LM665910	0.42	1.43	0.79	100	47.4
840	1830	630	850	KEE234156/K234215	0.48	1.26	0.69	114	44.6
900	1920	630	850	L467549/L467510	0.37	1.63	0.9	82	27.1
840	1830	630	850	KEE234160/K234215	0.48	1.26	0.69	107	41.8

Note: * indicates the maximum value of ID or OD.

Single-row Tapered Roller Bearing(Inch)

d 415.925~930 mm

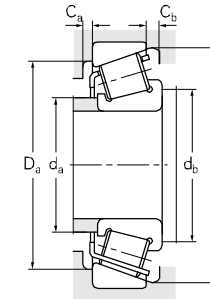
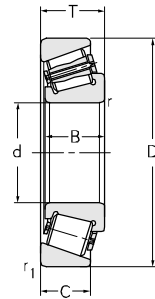
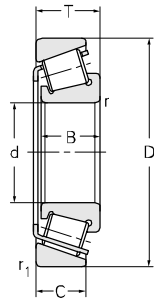

Principal dimensions											
d	D		T		B		C		r _{min}	R _{min}	
mm	in	mm	in	mm	in	mm	in	mm	in	mm	
415.925	16.375	590.55	23.25	114.3	4.5	114.3	4.5	88.9	3.5	6.4	6.4
431.800	17	571.5	22.5	74.612	2.937	74.612	2.937	52.388	2.063	3.3	3.3
447.625	17.623	635	25	120.650	4.75	120.650	4.75	95.250	3.75	6.4	6.4
457.2	18	573.088	22.563	74.612	2.937	74.612	2.937	57.150	2.25	6.4	6.4
		596.9	23.5	76.2	3	73.025	2.875	53.975	2.125	3.3	9.7
		596.9	23.5	76.2	3	73.025	2.875	53.975	2.125	3.3	9.7
482.6	19	634.873	24.995	80.962	3.187	80.962	3.187	63.5	2.5	3.3	6.4
498.475	19.625	634.873	24.995	80.962	3.187	80.962	3.187	63.5	2.5	3.3	6.4
501.65	19.75	711.2	28	136.525	5.375	136.525	5.375	106.363	4.188	6.4	6.4
549.275	21.625	692.15	27.25	80.962	3.187	80.962	3.187	61.912	2.437	6.4	6.4
607.72	23.926	787.4	31	93.662	3.687	93.662	3.687	69.85	2.75	6.4	6.4
		787.4	31	93.662	3.687	93.662	3.687	69.85	2.75	6.4	6.4
609.6	24	787.4	31	93.662	3.687	93.662	3.687	69.85	2.75	6.4	6.4
		787.4	31	93.662	3.687	93.662	3.687	69.85	2.75	6.4	6.4
660.4	26	812.8	32	95.25	3.75	95.25	3.75	73.025	2.875	6.4	6.4
760	29.921	889	35	88.9	3.5	88.9	3.5	72	2.835	3.3	3.3
760*		889	35	88.9	3.5	88.9	3.5	72	2.835	4	4
762	30	889	35	88.9	3.5	88.9	3.5	72	2.835	4	4
		889	35	88.9	3.5	88.9	3.5	72	2.835	3.3	3.3
928*		1060*		92	3.622	90	3.543	76	2.992	3.3	3.3
930*		1060*		92	3.622	90	3.543	76	2.992	3.3	3.3

Basic load ratings		Limit speed ratings		Designations	Calculation coefficient				Weight
C _r	C _{0r}	Grease	Oil		e	Y	Y ₀	a	
kN		r/min							kg
1810	4030	480	650	M268749/M268710	0.33	1.8	0.99	104	96.6
965	2080	500	670	KLM869448/KLM869410-3-SJ	0.44	1.35	0.8	111	47.2
2300	5450	430	560	M270749/M270710	0.33	1.8	1	111	121
1030	2690	480	630	KL570649/KL570610-3-SJ	0.4	1.5	0.8	101	41.9
1200	2500	450	600	EE244180/244235	0.4	1.5	0.8	102	50.8
1200	2500	450	600	KEE244180/K244235	0.4	1.5	0.8	102	50.8
1340	2950	630	850	KEE243190/K243250	0.34	1.76	0.97	100	66.2
1340	2950	420	580	EE243196/243250/HE	0.35	1.7	0.9	98	58.3
2760	6110	400	530	M274149/M274110	0.35	1.7	0.9	102	163
1350	3470	560	750	KL476549/KL476510	0.37	1.6	0.9	113	69.0
2200	2800	340	450	EE649239/649310	0.38	1.58	0.87	124	108
2120	5250	340	450	KEE649239/K649310	0.37	1.61	0.89	127	113
2120	5250	340	450	EE649240/649310	0.38	1.58	0.87	124	108
2080	5250	340	450	KEE649240/K649310	0.37	1.6	0.9	125	112
1800	4950	300	400	KL281147/KL281110	0.33	1.82	1	122	101
2270	6050	300	400	L183448/L183410/HCE-2-XD	0.32	1.88	1.04	127	92.5
2200	3200	260	360	L183448/L183410	0.32	1.88	1.04	127	93.5
2200	3200	260	360	L183449/L183410	0.32	1.88	1.04	127	91.9
2270	6050	260	360	L183449/L183410/HCE-2-XD	0.32	1.88	1.04	127	90.9
2120	7450	190	280	JL286948H/JL286910	0.33	1.8	1	152	117
2120	7450	190	280	JL286949H/JL286910	0.33	1.8	1	152	115

Note: * indicates the maximum value of ID or OD.

Double-row Tapered Roller Bearing(Metric DF)

d 55-120 mm

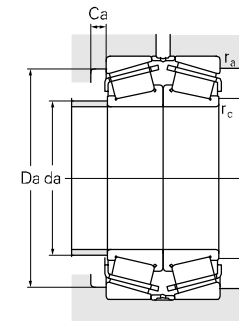
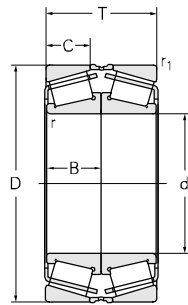
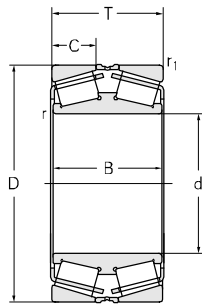

Principal dimensions							Basic load ratings		Limit speed ratings	
d	D	T	B	C	r _{min}	r _{1min}	C _r	C _{Or}	Grease	Oil
mm							kN		r/min	
55	90	54	27	21	0.5	1.5	174	292	3300	4400
60	130	67	67	22	1	2.5	261	350	1900	2800
70	110	55.5	55.5	19	0.5	1.5	178	324	2300	3000
75	130	55	50	22	0.5	1.5	214	350	2000	2600
	130	51.5	50	22	2	2.3	265	400	2000	2600
	130	54.5	50	22	2	2.3	265	400	2000	2600
	130	54.5	50	22	2	2.3	308	400	2000	2600
80	140	56.5	26	22	0.7	2	280	410	2100	2800
	140	56.75	52	22	0.7	2	228	356	2100	2800
	125	58	58	22	0.5	1.5	238	430	2100	2600
	110	50	20	50	0.5	1	132	240	2200	2800
	140	56.75	52	22	1	3	310	470	2100	2800
	140	56.75	52	22	1	3	310	470	2100	2800
140	56.75	52	22	1	3	310	470	2100	2800	
85	130	72	72	29.5	0.6	1.5	309	610	2000	2500
90	190	93	86	30	1	3	530	760	1400	1900
	140	78	78	32.5	0.3	1.5	381	735	1800	2300
100	180	74	68	29	0.8	2.5	450	710	1500	1900
	180	74	68	29	0.8	2.5	450	710	1500	1900
	180	74	68	29	0.8	2.5	450	710	1500	1900
	150	66	66	27	2*30*	1.5	294	560	1800	2300
110	220	76	76	38	0.8	2.5	395	615	1500	2000
	200	112	112	46	0.8	2.5	700	1350	1400	1700
	170	94	94	37	0.5	2	470	930	1300	1800
	170	66	70	27	1.5	2	350	690	1300	1800
120	215	87	80	34	0.8	2.5	570	890	1400	1900
	260	136	136	42	1	3	916	1380	950	1400

Designations	Calculation coefficient				Weight kg
	e	Y1	Y2	Yo	
33011/DF	0.31	2.16	3.22	2.12	1.73
31312/C9DF	0.83	0.81	1.2	0.8	4.05
32014/P5DFYA8	0.43	1.55	2.31	1.52	2.18
30215/DFP69YB2	0.44	1.55	2.31	1.52	3
370215/C9YAB-QC	0.44	1.55	2.31	1.52	2.95
370215/C91YAB-QC	0.44	1.55	2.31	1.52	2.95
370215/P6XC9YAB	0.44	1.55	2.31	1.52	2.95
30216/DF-1	0.42	1.61	2.39	1.57	3.28
30216/DF	0.42	1.61	2.39	1.57	3.28
32016/DF	0.42	1.6	2.38	1.56	2.61
32916/P5DF	0.35	1.92	2.86	1.88	1.28
370216/C9YAB-QC	0.42	1.61	2.39	1.57	3.71
370216/P6XYAB	0.42	1.61	2.39	1.57	3.71
370216/YAB-QC	0.42	1.61	2.39	1.57	3.71
33017/C9DF	0.29	2.32	3.45	2.26	3.49
31318/DF	0.83	0.82	1.22	0.8	11.7
33018/C9DF	0.27	2.51	3.74	2.45	4.58
370220/C9YAB-QC	0.42	1.61	2.39	1.57	7.89
370220/P6XYAB	0.42	1.61	2.39	1.57	7.89
370220/YAB-QC	0.42	1.61	2.39	1.57	7.89
370620/YAD	0.32	2.04	3.03	1.99	4.04
30622/DF	0.42	1.61	2.39	1.57	10.3
32222/DF	0.42	1.61	2.39	1.57	15.1
33022/C9DF	0.29	2.35	3.5	2.3	7.79
370622	0.32	2.11	3.14	2.06	5.66
30224/DF	0.44	1.55	2.31	1.52	13.4
31324/DF	0.83	0.81	1.2	0.8	33.5

Double-row Tapered Roller Bearing(Metric DF)

d 130~190 mm

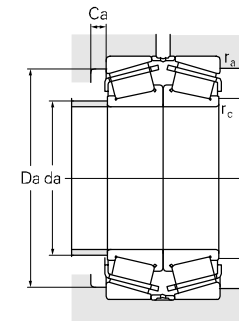
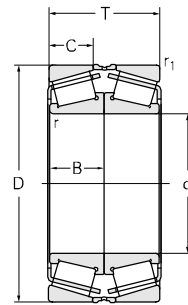
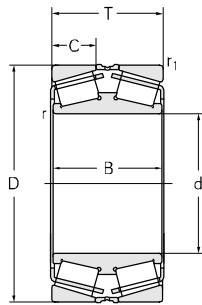

Principal dimensions							Basic load ratings		Limit speed ratings	
d	D	T	B	C	r _{min}	r _{1min}	C _r	C _{Or}	Grease	Oil
mm							kN		r/min	
130	200	90	90	34	0.6	2	600	1210	1300	1800
	230	135.5	135.5	54	1	3	933	1650	1100	1500
	280	144	132	44	1.3	4	1100	1680	1100	1500
140	210	90	90	34	0.6	2	550	1120	1200	1700
	240	100	100	40	1.5	3	950	1450	1000	1300
	270	120	120	41	3	3	1100	1600	970	1200
	300	154	70	47	1.3	4	1210	1842	900	1300
	300	154	70	47	1.3	4	1200	1840	850	1200
150	210	76	38	30	0.5	2	455	920	1200	1500
	225	96	96	36	0.6	2.5	625	1270	1200	1500
	225	97	90	38	1.1	2.5	450	930	1200	1500
	270	154	146	60	1	3	1210	2450	900	1300
160	240	102	102	38	0.8	2.5	722	1450	1000	1500
	240	102	102	41	0.9	2.5	722	1420	1000	1500
	240	102	102	41	0.9	2.5	722	1420	1000	1500
	240	76	76	29	1.5	3	485	910	1100	1400
	290	168	160	67	1	3	1480	2970	900	1300
	343	160	160	53.975	3.3	3.3	1520	2290	740	950
	290	168	160	67	1	3	1480	2970	900	1300
170	230	76	38	30	0.6	2	480	1120	1000	1400
	230	76	38	30	0.6	2	485	1120	1000	1400
	230	65	65	27	0.7	2	450	945	1000	1400
	260	114	114	43	1.3	2.5	890	1740	850	1400
	295	100	100	35	2.5	4	860	1360	950	1300
	310	182	172	71	1.3	4	1685	3250	850	1200
180	250	90	90	34	0.6	2	590	1430	950	1400
	250	90	90	36	0.7	2	500	1060	950	1400
	280	128	128	48	1	2.5	1080	2170	900	1300
	330	190	190	76	1.5	5	1800	3700	820	1040
	280	128	128	48	1	2.5	1080	2170	900	1300
190	290	128	128	48	1	2.5	1090	2280	850	1200

Designations	Calculation coefficient				Weight kg
	e	Y1	Y2	Yo	
32026/DF	0.43	1.55	2.31	1.52	10.5
32226/DF	0.44	1.53	2.28	1.5	23.7
31326/DF	0.55	0.82	1.22	0.8	40.9
32028/DF	0.46	1.47	2.18	1.43	11.8
370628X3/GW/HCYB2	0.39	1.74	2.59	1.7	18.8
370628D/HCYA3/W283	0.7	0.97	1.44	0.94	29.5
31328/DF	0.83	0.818	1.22	0.8	50.3
31328/DFC235	0.83	0.81	1.2	0.8	50.3
32930/DF	0.33	2.06	3.06	2.01	7.99
32030/DF	0.46	1.47	2.18	1.43	12.9
32030X2A/DF	0.37	1.83	2.72	1.79	14.1
32230/C3DF	0.44	1.55	2.31	1.52	38.4
32032/DFC425	0.46	1.47	2.19	1.44	15.8
32032X1A/DF	0.37	1.83	2.72	1.79	15.7
32032X2A/DFC150	0.37	1.83	2.72	1.79	15.7
370632	0.47	1.43	2.12	1.4	11.4
32232/DF	0.44	1.55	2.31	1.52	48.1
370632D/HC/W281	0.81	0.83	1.23	0.81	65.3
32934/P6DF-XD	0.38	1.76	2.62	1.72	9.31
32934/P59DF	0.38	1.76	2.62	1.72	9.31
370634	0.29	2.36	3.51	2.31	6.79
32034/DF	0.44	1.52	2.26	1.49	21.9
370634-1/C9	0.87	0.78	1.16	0.76	27.8
370634-1D	0.87	0.78	1.16	0.76	26.7
32234/HCDF	0.44	1.55	2.31	1.52	61.9
32936/DF	0.48	1.4	2.1	1.4	13.5
32936X2A-1/DF	0.48	1.4	2.1	1.4	12.7
32036/DFC425	0.42	1.6	2.38	1.56	28.9
370636D/HCYA3	0.58	1.16	1.72	1.13	71.6
32038/DFC395	0.44	1.53	2.27	1.49	30.1

Double-row Tapered Roller Bearing(Metric DF)

d 190~280 mm

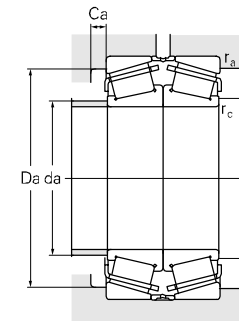
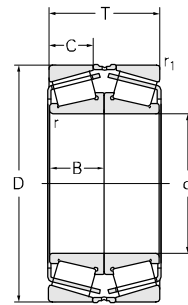
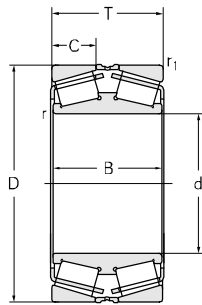

Principal dimensions							Basic load ratings		Limit speed ratings	
d	D	T	B	C	r _{min}	r _{1min}	C _r	C _{Or}	Grease	Oil
mm							kN		r/min	
190	290	100	100	39	2.5	2.5	815	1670	850	1200
200	310	140	70	53	0.8	2.5	1270	2620	840	1100
	310	140	140	53	0.8	2.5	1260	2620	840	1100
	310	140	70	53	0.8	2.5	1270	2620	840	1100
	310	140	140	53	0.8	2.5	1260	2620	840	1100
203.2	292.1	107.95	107.95	46.038	3	3.3	850	2000	840	1100
210	300	100	100	38	2	3	760	1780	820	1000
	365	170	170	68	4	4	1850	3600	730	930
220	340	152	152	57	1.1	3	1510	3100	750	1000
	360	120	120	39	3	4	1000	2000	750	1000
	360	120	120	39	3	4	1000	2000	750	1000
230	350	92	92	33	3	4	795	1640	680	870
240	360	152	76	57	1	3	1820	3300	690	920
	360	152	76	57	1	3	1820	3300	690	920
	440	254	254	100	1.3	4	1870	3550	680	930
259.5	481	250	250	98	2.5	5	3630	7100	580	770
	481	250	250	250	2	5	3450	7050	580	770
260	400	174	174	65	1.3	4	1940	4100	630	840
	480	274	260	105	1.3	5	3800	7600	460	590
	420	170	170	70	5	5	1790	4050	630	840
	420	170	170	70	5	5	1970	4050	630	840
280	420	174	87	65	1.3	4	2050	4600	600	800
	380	129	120	52	0.9	2.5	1100	2770	620	820
	389.5	92	92	30	4	4	870	1880	600	800
	389.5	92	92	30	4	4	1028	2222	600	800
	389.5	92	92	30	4	4	870	1450	600	800

Designations	Calculation coefficient				Weight kg
	e	Y1	Y2	Yo	
372038X2A	0.4	1.68	2.5	1.64	23.8
32040/DF	0.43	1.57	2.34	1.53	40.2
32040/DFC275YB2	0.43	1.6	2.3	1.6	40.2
32040/DFC485	0.43	1.57	2.34	1.53	40.2
32040/HCDF	0.43	1.6	2.3	1.6	40.2
3706/203.2/C9YA3	0.33	2.03	3.02	1.98	24.3
370642-FM	0.58	1.17	1.75	1.15	23.2
370642/HC	0.42	1.61	2.4	1.58	76.1
32044/DFC525	0.43	1.57	2.34	1.53	49.5
370644/C9	0.87	0.78	1.16	0.76	47.5
370644D	0.87	0.78	1.16	0.76	44.4
370646/HG2	0.55	1.24	1.84	1.21	31.9
32048/DF	0.46	1.47	2.19	1.44	54.0
32048/HCDF	0.46	1.5	2.2	1.4	53.9
32248/DF	0.43	1.6	2.3	1.6	169
3706/259.5	0.45	1.5	2.23	1.47	214
3706/259.5-1/HCC9	0.49	1.38	2.06	1.35	211
32052/DF	0.43	1.55	2.31	1.52	82.6
32252/DF	0.43	1.57	2.34	1.53	218
370652D	0.48	1.41	2.09	1.37	88.4
370652D/HC	0.48	1.41	2.09	1.37	88.4
32056/DFC660	0.46	1.5	2.2	1.4	84.0
32956X2A/DF	0.32	2.1	3.13	2.05	44.1
370656	0.82	0.82	1.22	0.8	33.3
370656/HC	0.82	0.82	1.22	0.8	33.3
370656/YAD	0.82	0.82	1.22	0.8	30.8

Double-row Tapered Roller Bearing(Metric DF)

d 290~305.1 mm

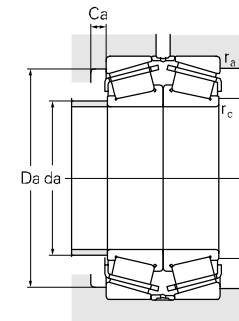
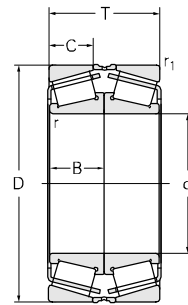
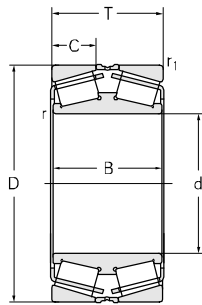

Principal dimensions							Basic load ratings		Limit speed ratings	
d	D	T	B	C	r _{min}	r _{1min}	C _r	C _{Or}	Grease	Oil
mm							kN		r/min	
290	450	180	180	65	3	4	2150	4300	560	750
295.3	557	170	180	44	5	5	3150	3750	360	460
300	420	152	152	57	1.3	3	1754	3600	600	800
	440	105	105		4	4	980	2050	560	740
	440	104.749	105	35	4	4	980	2050	560	740
	440	105	105	35	4	4	1020	2300	560	740
	440	105	105	35	4	4	1020	2300	560	740
	440	105	105	35	4	4	925	2030	560	740
	560	170	170	50	5	5	3520	3800	500	660
	560	170	170	50	5	5	3520	3800	500	660
	560	170	170		5	5	3150	3750	500	660
	440	105	105	35	4	4	925	2030	560	740
	460	105	105	35	4	2	925	2030	560	740
	500	200	200	70	5	5	2550	5200	390	490
	420	152	152	53	3	3	1754	3600	600	800
	423	152	152	53	3	3	1630	3300	600	800
305	500	200	200	63.5	4.3	6	3100	4850	530	710
	500	200	200	63.5	4.3	6	3100	4850	530	710
	500	200	200	63.5	4.3	6	3100	4850	530	710
305.03	499.948200.025	200.025	200.025	63.5	3.3	6.4	2630	4850	530	710
	499.948200.025	200.025	200.025	63.5	3.3	6.4	2630	4850	530	710
	499.948200.025	200.025	200.025	63.5	3.3	6.4	2630	4850	530	710
	499.948200.025	200.025	200.025	63.5	3.3	4	2630	4850	530	710
305.034	499.948200.025	200.025	200.025	63.5	3.3	6.5	2630	4850	530	710
305.07	500	200	200	70	6.4	4.8	1870	3550	530	710
	500	200	200	67	6.4	4.8	2350	5020	530	710
	500	200	200	67	6.4	4.8	2350	5020	530	710
	500	200	200	67	3	5	2400	5100	530	710
305.1	500	200	200	70	6.4	4.8	1870	3550	450	620

Designations	Calculation coefficient				Weight kg
	e	Y1	Y2	Yo	
370658D/HCEYAT	0.87	0.78	1.16	0.76	103
370660-RS/HCC9-1	0.81	0.83	1.23	0.81	194
32960/DFC695	0.39	1.71	2.54	1.67	62.9
370660D/HCYAD	0.88	0.77	1.15	0.8	55.5
370660D/HCYAD-1	0.88	0.77	1.15	0.8	55.4
370660D/HCYAD-2	0.88	0.77	1.15	0.8	56.0
370660D/HCYAT	0.88	0.77	1.15	0.8	56.3
370660D/YAD	0.88	0.77	1.15	0.8	55.5
370660/HCC9	0.81	0.823	1.23	0.81	197
370660/HC	0.81	0.823	1.23	0.81	197
370660-RS/HCC9	0.81	0.823	1.23	0.81	189
370660/YA3	0.88	0.77	1.15	0.8	58.8
370660/YAD	0.88	0.77	1.15	0.8	62.2
371160X2	0.7	0.97	1.44	0.94	153
372960/HCYAD	0.67	1	1.5	1	64.4
372960X1/HCYAD	0.67	1.01	1.5	0.99	65.8
370661D/HCEYADT	0.88	0.77	1.15	0.8	144
370661D/HCEYADT-1	0.88	0.77	1.15	0.75	144
370661D/YADT	0.88	0.77	1.15	0.75	144
3706/305X4D/HCEYAD-1	0.88	0.77	1.15	0.75	143
3706/305X4D/HCEYAD-1/W281	0.88	0.77	1.15	0.8	143
3706/305X4D/HCEYADT	0.88	0.77	1.15	0.75	144
3706/305X4D/HCEYADT-1	0.88	0.77	1.15	0.8	144
3706/305X4D/HCEYAD	0.88	0.77	1.15	0.75	143
3706/305X4	0.79	0.854	1.27	0.835	122
3706/305X4D/HCYA3-1	0.88	0.77	1.15	0.8	155
3706/305X4D/HCYA3-2	0.88	0.77	1.15	0.8	155
3706/305X4/HCC9YAB	0.88	0.77	1.15	0.8	163
3706/305.1D/HCYAB	0.79	0.85	1.27	0.83	115

Double-row Tapered Roller Bearing(Metric DF)

d 305.2~390 mm

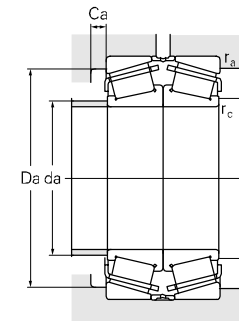
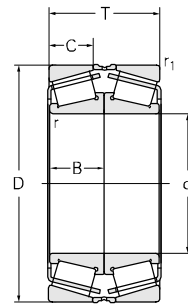
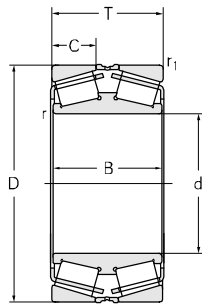

Principal dimensions							Basic load ratings		Limit speed ratings	
d	D	T	B	C	r _{min}	r _{1min}	C _r	C _{or}	Grease	Oil
mm							kN		r/min	
305.2	500	200	70	200	6.4	4.8	1870	3550	530	710
320	480	200	74	200	1.3	4	2587	6200	530	700
	440	152	57	152	1.5	3	1720	4370	410	520
	620	282	85	250	2.5	5	4100	7700	400	550
	620	280	115	280	3	5	5300	10600	400	550
	620	280	115	280	3	5	5300	10600	400	550
	620	280	115	280	6	5	5300	10600	400	550
	620	280	85	250	4	5	4100	7700	400	550
	459.5	140	57	140	3	2	1550	3750	410	520
330	520	180	70	180	3	3	2250	5050	360	460
	540	186	73	186	5	5	3700	6250	350	450
	540	176	62	176	5	5	2450	5100	430	570
339	600.5	264	100	264	3	6	4800	9700	500	660
340	580	243	94	243	4	4	4150	8500	370	500
360	680	330	110	300	5	6	5960	11800	380	500
	680	330	110	300	6	6	6540	10800	380	500
	560	160	160	3	5	2350	4640	380	500	500
	680	330	300	4	7.5	6300	12000	320	400	400
	560	160	55	160	3	5	2300	4800	380	500
	680	330	128	300	2.5	7.5	6300	12000	380	500
379	681.5	307	115	307	5	6	5700	11500	530	710
380	570	180	70	180	2	5	2910	6150	410	540
	570	180	70	180	2	5	2910	6150	410	540
	570	180	65	180	2	4	2600	5850	410	540
	520	145	56	145	4	4	2050	4950	340	440
385	530	180	65	180	2	4	2220	5700	330	420
390	570	200	69	200	5	5	2800	7000	380	500

Designations	Calculation coefficient				Weight kg
	e	Y1	Y2	Yo	
3706/305.2D	0.79	0.854	1.27	0.835	115
32064/DF	0.46	1.47	2.19	1.44	130
32964/DFC725	0.42	1.62	2.42	1.59	69.5
370664/HCC9	0.73	0.92	1.37	0.9	353
370664X2	0.43	1.57	2.43	1.53	408
370664X2/HCC9YA6	0.43	1.57	2.43	1.53	408
370664X2/HCC9YA6	0.43	1.57	2.43	1.53	408
370664/YAB	0.73	0.92	1.38	0.9	350
375964X3	0.41	1.66	2.47	1.63	79.2
370666D/HCEYAB	0.87	0.78	1.16	0.76	142
370666/HCC9YA3-1	0.33	2.03	3.02	1.98	174
370666/HCC9YAB	0.87	0.77	1.15	0.8	173
306/339/HCC9DFYAB	0.43	1.57	2.43	3.06	324
370668/HC					271
30672/DFYAB	0.6	1.15	1.7	1.1	506
30672/HCDFYAB	0.62	1.1	1.63	1.07	503
370672	0.72	0.94	1.4	0.9	141
370672/HC	0.6	1.1	1.7	1.1	526
370672/HCYA3-1	0.72	0.94	1.4	0.9	133
370672/HCYAD	0.6	1.1	1.7	1.1	523
306/379/DF	0.43	1.57	2.34	3.14	492
371076X3D/HCEYAB	0.87	0.78	1.16	0.76	162
371076X3D/HCYAD	0.87	0.78	1.16	0.76	162
371076X3/HCEC9YB2	0.87	0.78	1.16	0.76	165
371976	0.38	1.77	2.64	1.73	89.2
3706/385	0.38	1.77	2.64	1.73	116
370678	0.83	0.81	1.2	0.8	166

Double-row Tapered Roller Bearing(Metric DF)

d 390~431.902 mm

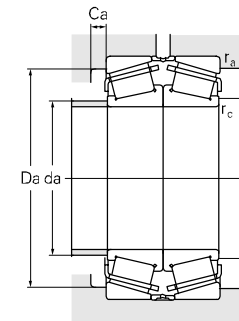
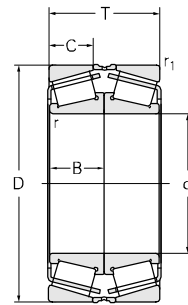
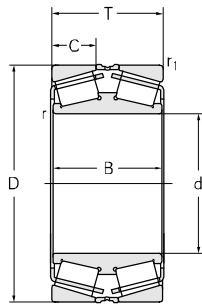

Principal dimensions							Basic load ratings		Limit speed ratings	
d	D	T	B	C	r _{min}	r _{1min}	C _r	C _{Or}	Grease	Oil
mm							kN		r/min	
390	568	180	180	63	3	5	2280	5420	380	500
	567.5	180	180	70	3	5	2610	6520	380	500
400	650	240	240	77	6	6	3550	7300	360	480
	650	240	240	80	6	6	3400	8400	360	480
	650	240	240	77	6	6	3550	7300	360	480
	650	240	240	80	6.4	6.4	3450	8200	360	480
	650	240	240	80	6	6	3400	8400	360	480
	650	240	240	80	SP	6	3400	8400	360	480
	650	240	240	77	6	6	3550	7300	360	480
	560	240	240	77	6	6	4170	7300	360	480
	560	240	240	80	6	6	3400	8400	360	480
	560	240	240	77	6	6	3740	8400	360	480
	780	380	380	135	5	6	7300	14800	330	450
	650	240	240	80	6	6	3400	8400	360	480
	650	200	200	60	6	6	2900	6250	360	480
	650	200	200	68.25	6	6	3400	6500	360	480
	780	380	380	155	7.5	7.5	10000	17300	330	450
	780	380	380	135	5	6	7300	14800	330	450
	600	189	190	63	5	4	2680	5500	410	540
406.4	762	330	330	116.5	3.3	6.4	6000	13100	330	450
	762	330	330	116.5	3.3	6.4	6000	13100	330	450
410	580	160	160	55	7	4	2060	5080	360	480
420	740	330	330	135	3	6	6500	16000	350	450
	700	224	224	86	6	6	4540	9480	360	480
	700	224	224	86	6	5	4900	9550	360	480
431.902	685.698254	254	106	3.3	6.4	4500	10700	280	380	
	685.698253.873	253.873	106	3.5	8	5010	11000	280	380	

Designations	Calculation coefficient				Weight kg
	e	Y1	Y2	Yo	
370678/HC-1	0.83	0.81	1.21	0.79	153
370678/HCYA3	0.73	0.92	1.37	0.9	157
370680D/HCEYAD	0.87	0.78	1.16	0.76	279
370680D/HCEYAD-1	0.87	0.78	1.16	0.76	299
370680D/HCEYAD-2	0.87	0.78	1.16	0.76	279
370680D/HCEYAT	0.88	0.77	0.15	0.8	290
370680D/HCYA3	0.87	0.78	1.16	0.76	299
370680D/HCYA36	0.87	0.78	1.16	0.76	299
370680D/HCYA38	0.87	0.78	1.16	0.76	279
370680D/HCYAD	0.88	0.77	0.15	0.8	279
370680D/HCYADT	0.88	0.77	0.15	0.8	300
370680D/YAD	0.87	0.78	1.16	0.76	279
370680/HCC9-3	0.7	0.96	1.44	0.94	854
370680/HCYAB	0.87	0.78	1.16	0.76	313
370680X2-2/HCC9YAB	1.05	0.64	0.96	0.63	264
370680X2D/HCYAB	0.87	0.78	1.16	0.76	252
370680X3/HCYAD	0.38	1.78	2.65	1.74	883
370680X3/YAB	0.7	0.96	1.44	0.94	856
371080X2	0.38	1.78	2.65	1.74	174
3706/406.4D/HC-JG	0.75	0.9	1.34	0.88	659
3706/406.4/HCYAD	0.75	0.9	1.34	0.88	660
370682/HCYA3	0.87	0.78	1.16	0.76	133
370684/HC	0.32	2.12	3.15	2.07	642
373184	0.32	2.12	3.15	2.07	382
373184/HCC9	0.32	2.12	3.15	2.07	382
3706/431X4	0.33	2	3	2	358
3706/431X4/HC	0.33	2.03	3.02	1.98	358

Double-row Tapered Roller Bearing(Metric DF)

d 431.902~510.13 mm

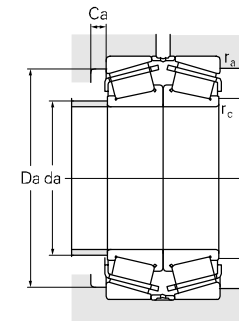
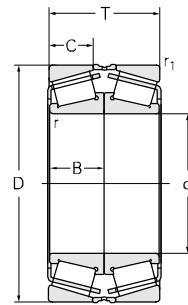
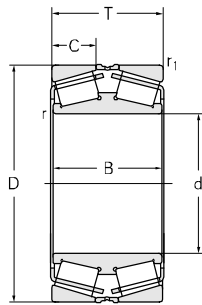

Principal dimensions							Basic load ratings		Limit speed ratings	
d	D	T	B	C	r _{min}	r _{1min}	C _r	C _{Or}	Grease	Oil
mm							kN		r/min	
431.902	685.698	254	254	106	3.3	6.4	5010	11000	280	380
440	820	360	360	135	4	7.5	6100	11000	320	420
460	860	420	210	155	7.5	7.5	9490	20300	300	400
	860	420	380	162	6	5	10600	20600	300	400
	860	420	380	162	6	5	10600	20600	300	400
	860	420	380	162	2.5	5	10600	20600	300	400
	950	480	450	180	6	5	11600	24800	300	400
680	230	230	85	4	4	3910	9400	360	480	
465	845	410	410	155	7.5	7.5	9200	19600	220	300
480	950	500	500	185	9	9	13600	25000	250	320
	950	480	450	180	4	7.5	11900	25100	250	320
	950	480	450	180	4	7.5	11900	25100	250	320
	950	440	440	160	9.5	9.5	11900	22100	250	320
	950	430	400	160	5	7.5	11700	22100	250	320
	950	440	400	165	5	7.5	11700	22100	250	320
	950	480	450	180	4	7.5	11200	25100	250	320
482.6	733.425	199.263	200	65	3.3	4	4050	7400	250	320
500	720	218	185	80	6	6	3000	7400	220	280
501.65	711.2	250.825	250.825	106.363	3.2	6.4	4950	13400	220	280
509.948	733.425	200.025	200.025	68	3.3	4.8	3850	8400	330	430
509.998	733.5	200.02	200.02	68	3.3	4.8	3830	8320	330	430
510	800	350	350	121	7.5	7.5	8400	17600	330	430
	733.5	200	200	68	3.3	3.3	3830	8320	330	430
510.13	800	285	285	100	5	10	4950	12500	330	430
	800	285	285	100	5	8	5440	12500	330	430

Designations	Calculation coefficient				Weight kg
	e	Y1	Y2	Yo	
3706/431X4/HCEC9YAD	0.33	2	3	2	358
370688/HC	0.58	1.17	1.75	1.15	892
30692-1/HCDF	0.57	1.2	1.8	1.1	1110
370692-1/HCYA6	0.68	0.99	1.48	0.97	1130
370692-1/YA6	0.68	0.99	1.48	0.97	1130
370692/HC-1	0.68	0.99	1.48	0.97	1130
370692/HCC9YAD	0.68	0.99	1.48	0.97	1668
371092	0.61	1.11	1.66	1.09	293
30693/DF	0.42	1.62	2.42	1.59	1021
370696/HCC9YB2-2	0.7	0.96	1.44	0.94	1720
370696/HCEYB2-1	0.73	0.92	1.38	0.9	1640
370696/HCEYB2-1	0.73	0.92	1.38	0.9	1640
370696X2/HCC9YB2	0.58	1.17	1.75	1.15	1467
370696X2/HCEC9	0.58	1.16	1.73	1.14	1431
370696X2/HCEC9-1	0.58	1.16	1.73	1.14	1453
370696/YB2	0.73	0.92	1.37	0.9	1640
3706/482.6/HC	0.78	0.86	1.29	0.84	285
3706/500-1/C9	0.7	0.97	1.44	0.94	288
3706/500/HC	0.35	1.92	2.86	1.88	323
3706/509X4D/HCYAT	0.87	0.78	1.16	0.76	265
3706/509X4D/HCYA3	0.87	0.78	1.16	0.76	265
306/510/HCC9DF	0.47	1.44	2.14	2.8	914
3706/510D/HCYAB	0.87	0.78	1.16	0.76	265
3706/510X4D/HCYA3	0.88	0.76	1.34	0.75	532
332171	0.89	0.763	1.14	0.746	532

Double-row Tapered Roller Bearing(Metric DF)

d 530~690 mm

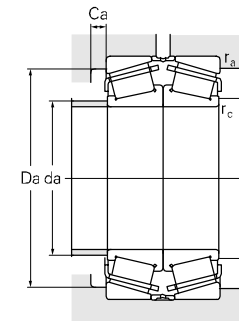
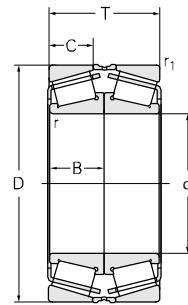
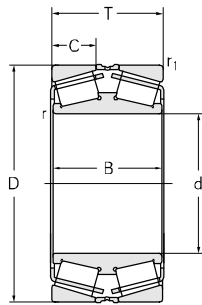

Principal dimensions							Basic load ratings		Limit speed ratings	
d	D	T	B	C	r _{min}	r _{1min}	C _r	C _{Or}	Grease	Oil
mm							kN		r/min	
530	730	250	250	104	6	6	5060	13400	320	420
	730	250	250	104	6	6	5150	13700	320	420
	730	250	250	104	6	6	5050	13400	320	420
	710	190	190	65	5	5	2660	7650	320	430
540	860	256	256	92	7.5	7.5	5400	12400	320	420
560	1000	450	450	190	9.5	6	15200	30300	160	210
570	750	240	240	100	6	6	3850	11800	310	410
580	990	390	390	145	7.5	7.5	10600	24000	290	380
	830	280	280	115	3	6	6250	16400	290	380
600	870	270	270	98	6	6	5670	14300	280	380
	800	190	190	68	5	4	3470	9200	290	390
600.5	819	172	172	66	2	2	3920	8900	280	380
620	1030	370	370	148	15	10	12600	23600	300	390
	1030	400	400	143	3.3	6.4	10100	23400	300	390
630	1030	400	400	143	3.3	6.4	10100	23400	300	390
	1030	400	400	143	3.3	6.4	10100	23400	300	390
635	939.8	304.8	305.105	110	3.3	6.4	5800	17000	280	380
	939.8	305	305	107.95	3.3*7.5	6.4	5800	17000	280	380
	939.8	304.8	304.8	110	3.3	6.4	5800	17000	280	380
	940	305	305	107.95	3.3	6.4	5800	17000	280	380
	939.8	304.8	304.8	110	3.3	6.4	5400	9400	280	380
670	980	230	230	78	7.5	9.5	6000	13000	250	340
685.8	939.8	227.81	234.8	80	3.3	6.4	4550	12200	220	310
	939.8	228.6	234.95	82.55	6.4	6.4	4550	12200	220	310
690	980	355	355	152	6.5	6.5	9380	25900	210	280

Designations	Calculation coefficient				Weight kg
	e	Y1	Y2	Yo	
3706/530	0.34	2	2.97	1.95	323
3706/530/HC-1	0.34	2	2.97	1.95	318
3706/530/HC	0.34	2	2.97	1.95	323
3719/530	0.73	0.92	1.37	0.9	212
3706/540/HC	0.7	0.97	1.44	0.94	581
3706/560/HC	0.42	1.59	2.37	1.55	1620
3706/570/HC	0.5	1.36	2.02	1.33	287
306/580/HCC9DFYB2	0.31	2.2	3.3	2.4	1297
	0.31	2.2	3.3	2.2	546
3710/600	0.61	1.11	1.66	1.09	726
3719/600X2	0.61	1.11	1.66	1.09	270
3706/600.5/HCYA6	0.61	1.11	1.66	1.09	265
3706/620/HCC9	0.32	2.12	3.15	2.07	1265
3706/630	0.75	0.9	1.34	0.88	1330
	0.75	0.9	1.34	0.88	1330
3706/635D/HC	0.83	0.818	1.22	0.8	697
3706/635D/HCER-1	0.83	0.818	1.22	0.8	731
3706/635/HC	0.83	0.818	1.22	0.8	721
3706/635/HC-1	0.88	0.77	1.14	0.75	762
3706/635/HCC9	0.83	0.82	1.22	0.8	721
3706/670/HCC9YA3	0.7	0.97	1.44	0.94	576
3706/685.8D/HCYAB	0.87	0.78	1.16	0.76	444
3706/685.8D/HCYADT	0.87	0.78	1.16	0.76	447
3706/690/HCC9YB2	0.35	1.95	2.9	1.91	880

Double-row Tapered Roller Bearing(Metric DF)

d 690~900 mm

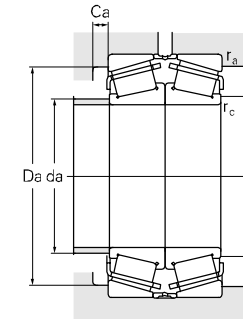
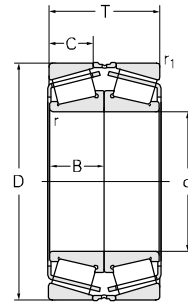
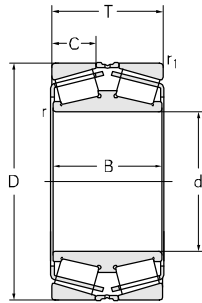

Principal dimensions							Basic load ratings		Limit speed ratings	
d	D	T	B	C	r _{min}	r _{1min}	C _r	C _{Or}	Grease	Oil
mm							kN		r/min	
690	980	355	355	152	6.5	6.5	9380	25900	210	280
	980	355	355	152	6	6.5	9380	25900	210	280
710	900	197	197	79	3	6	4750	13700	250	320
724	915	187	187	70	5	5	3450	11600	250	320
800	1100	300	300	112	1.5	6	6980	20700	210	270
	1100	300	300	112	1.5	6	7000	20700	210	270
	1100	300	300	112	1.5	6	7000	20700	210	270
900	1220	300	300	108	3.3	12.7	9100	23000	200	250

Designations	Calculation coefficient				Weight kg
	e	Y1	Y2	Yo	
3706/690/HCC91YB2	0.35	1.95	2.9	1.91	880
3706/690/HCEC9YB2	0.35	1.95	2.9	1.91	880
3706/710/HCC9	0.35	1.9	2.9	1.8	314
3706/724/HC	0.38	1.77	2.64	1.73	293
3706/800D	0.79	0.85	1.25	0.8	853
3706/800/HCC9	0.79	0.85	1.25	0.8	862
3706/800/HC-JG	0.79	0.85	1.25	0.8	862
3706/900/HCYA6	0.81	0.83	1.23	0.81	997

Double-row Tapered Roller Bearing(Inch DF)

d 34.925~190.5 mm

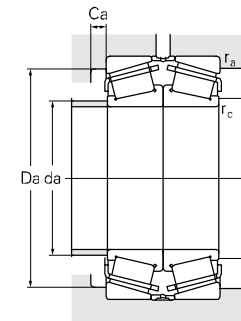
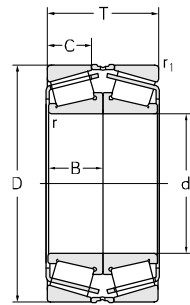
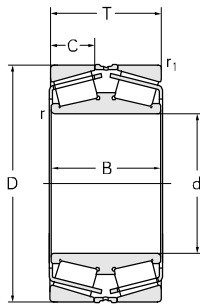

Principal dimensions											
d		D		T		B		C		r _{1min1}	r _{min}
mm	in	mm	in	mm	in	mm	in	mm	in	mm	
34.925	1.375	65.088	2.563	36.068	1.42	36.068	1.42	13.97	0.55	1.3	0.7
63.5	2.5	112.712	4.437	60.452	2.38	60.452	2.38	23.812	0.937	3.3	0.6
72.072	2.837	120	4.724	69.04	2.718	67.539	2.659	24.237	0.954	2	0.8
76.2	3	171.45	6.75	98.424	3.875	98.424	3.875	31.75	1.25	3.3	0.8
85	3.346	130	5.118	60	2.362	29	1.142	24	0.945	2.5	0.6
85.136	3.352	139.992	5.511	80.962	3.187	80.134	3.155	28.575	1.125	3.3	0.8
90*		147		80	3.15	40	1.575	32.5	1.28	3.5	0.5
100.211	3.945	168.275	6.625	95.25	3.75	95.25	3.75	30.162	1.187	3.3	0.8
101.6	4	214.312	8.437	111.124	4.375	52.388	2.063	39.688	1.563	3.3	0.7
127	5	182.562	7.187	72.6	2.858	72.6	2.858	33.338	1.313	3.3	1.5
133.35	5.25	196.85	7.75	92.075	3.625	92.075	3.625	38.1	1.5	3.3	1.5
		196.85	7.75	92.075	3.625	92.075	3.625	38.1	1.5	3.3	1.5
136.525	5.375	215.9	8.5	123.825	4.875	123.825	4.875	34.925	1.375	3.3	1.5
139.7	5.5	200.025	7.875	77.788	3.063	75.408	2.969	34.13	1.344	3.3	0.8
147.638	5.813	241.3	9.5	133.35	5.25	132.334	5.21	44.45	1.75	3.3	1.5
152.4	6	298.45	11.75	107.95	4.25	111.125	4.375	44.45	1.75	3.3	3.3
161	6.339	231.775	9.125	84.138	3.313	90.488	3.563	34.925	1.375	3.3	1.5
180.975	7.125	288.925	11.375	158.75	6.25	158.75	6.25	47.625	1.875	3.3	1.5
190.5	7.5	266.7	10.5	90.488	3.563	89.695	3.531	38.1	1.5	3.3	1.5

Basic load ratings		Limit speed ratings		Designations	Calculation coefficient				Weight
C _r	C _{0r}	Grease	Oil		e	Y	Y ₀	a	
kN		r/min						kg	
80	120	4400	5500	KLM48548/KLM48510-2/C9DF	0.38	1.79	2.67	1.75	0.546
198	345	2400	3100	K3982/K3920YA4-2/C9DF	0.4	1.68	2.5	1.64	2.57
232	380	3100	4000	K487TD/K472/YA10	0.38	1.78	2.64	1.74	2.84
480	700	1700	2200	K9380/K9321-2/DF	0.76	0.88	1.31	0.86	10.3
250	460	2000	2700	KJM716649/KJM716610/DFYA8	0.44	1.53	2.28	1.5	2.89
300	520	1900	2500	K579TD/K572	0.4	1.67	2.49	1.63	4.8
410	690	1800	2400	KHM218248/KHM218210/C9DF	0.33	2.03	3.02	1.98	5.19
370	700	1800	2400	K688TD/K672	0.47	1.43	2.14	1.4	8.29
700	1170	1500	2000	KH924033/KH924010/DF	0.67	1.01	1.5	0.99	18.3
375	815	1200	1500	K48290DW/K48220	0.31	2.21	3.29	2.16	6.38
590	1250	1200	1500	K67390D/K67322	0.34	1.96	2.92	1.92	9.68
590	1250	1200	1500	K67390TD/K67322	0.34	1.96	2.92	1.92	9.66
550	1020	1200	1500	K74539TD/K74850	0.32	2.12	3.15	2.07	9.9
475	955	1200	1500	K48680D/K48620	0.34	2.01	2.99	1.96	8.18
700	1400	1200	1500	K82581TD/K82950	0.44	1.52	2.27	1.49	32.6
990	1720	940	1300	KEE517060D/K517117	0.33	2.05	3.05	2	35.7
590	1230	1000	1300	KM333546TD/KM333510	0.33	2.03	3.02	1.98	13.2
985	2020	940	1300	K94713TD/K94113	0.47	1.44	2.15	1.41	39.8
615	1520	940	1300	K67885DW/K67820	0.48	1.41	2.11	1.38	15.9

Note: * indicates the maximum value of ID or OD.

Double-row Tapered Roller Bearing(Inch DF)

d 203.2~304.8 mm

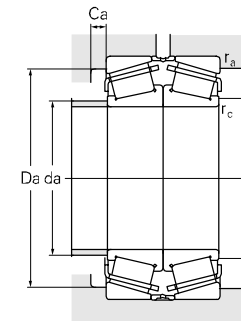
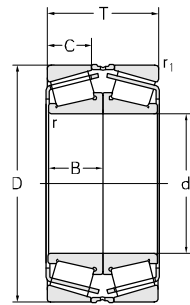
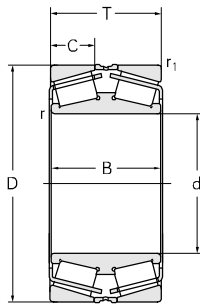

Principal dimensions											
d		D		T		B		C		r1min1	rmin
mm	in	mm	in	mm	in	mm	in	mm	in	mm	
203.2	8	317.5	12.5	133.35	5.25	133.35	5.25	46.038	1.813	3.3	6.4
220.662	8.687	314.325	12.375	115.886	4.562	115.888	4.563	49.213	1.938	3.3	1.5
		314.325	12.375	115.886	4.562	115.888	4.563	49.213	1.938	3.3	1.5
231.775	9.125	317.5	12.5	95.25	3.75	52.388	2.063	36.512	1.437	3.3	0.8
247.65	9.75	406.4	16	215.9	8.5	219.075	8.625	93.662	3.687	6.4	3.3
254	10	438.15	17.25	165.1	6.5	165	6.496	63.5	2.5	6.4	3.3
		444.5	17.5	133.35	5.25	133.35	5.25	50.8	2	6.4	3.3
260.35	10.25	406.4	16	155.575	6.125	152.4	6	66.675	2.625	6.4	3.3
		444.5	17.5	196.85	7.75	196.85	7.75	73.025	2.875	6.4	5
269.875	10.625	381	15	136.525	5.375	136.525	5.375	57.15	2.25	3.3	3.3
279.4	11	457.2	18	244.475	9.625	244.475	9.625	106.362	4.187	6.4	1.5
279.578	11.007	380.898	14.996	117.475	4.625	117.475	4.625	49.212	1.937	3.3	1.5
		380.898	14.996	117.475	4.625	117.475	4.625	49.212	1.937	3.3	1.5
288.925	11.375	406.4	16	144.462	5.687	144.462	5.687	60.325	2.375	3.3	1.5
		406.4	16	144.462	5.687	144.462	5.687	60.325	2.375	3.3	3.3
300	11.811	479.5	18.878	180	7.087	180	7.087	64	2.52	4.0	2.5
		479.5	18.878	180	7.087	180	7.087	64	2.52	4	2.5
		479.5	18.878	180	7.087	180	7.087	64	2.52	4	2.5
300.038	11.813	422.275	16.625	150.812	5.937	150.812	5.937	63.5	2.5	3.3	3.3
		422.275	16.625	150.812	5.937	150.812	5.937	63.5	2.5	3.3	3.3
303.212	11.937	495.3	19.5	263.525	10.375	263.525	10.375	114.3	4.5	6.4	3.3
304.8	12	501.65	19.75	161.922	6.375	161.925	6.375	61.117	2.406	6.4	3.3

Basic load ratings		Limit speed ratings		Designations	Calculation coefficient				Weight
Cr	Cor	Grease	Oil		e	Y	Yo	a	
kN		r/min						kg	
1040	2270	720	910	K93801D/K93125	0.52	1.29	1.92	1.26	38.8
1010	2350	760	1000	KM244249DW/KM244210/YB2	0.33	2.03	3.02	1.98	28.6
				M244249DW/M244210/YB2	0.33	2.03	3.02	1.98	29.3
835	1850	760	1000	KLM245848/KLM245810/DF	0.33	2.03	3.02	1.98	22.8
2900	6400	760	1000	KHH249949D/KHH249910	0.33	2.03	3.15	1.98	114
2200	3900	580	770	EE738101D/738172	0.35	1.92	2.86	1.88	104
				EE822101D/822175	0.33	2.06	3.06	2.01	88
1620	3520	670	900	EE324103D/324160	0.33	2.03	3.02	1.98	79.9
				EE823103D/823175A6/YB2	0.55	1.23	1.83	1.2	126
1600	3700	540	700	M252349D/M252310-1/C9	0.33	2.03	3.02	1.98	51.5
3850	7400	600	800	HH255149D/HH255110	0.33	2.03	3.02	1.98	164
1130	2830	650	900	KLM654644D/KLM654610	0.43	1.57	2.34	1.53	39.2
				LM654644D/LM654610/C9	0.43	1.57	2.34	1.53	39.2
1790	4200	580	770	KM255449TD/KM255410	0.34	2	2.98	1.96	61.66
				M255449D/M255410	0.34	2	2.98	1.96	63.3
2550	4800	480	650	JHM957540D/JHM957519/HCEC9YA3-2	0.73	0.92	1.38	0.9	127
				JHM957540DW/JHM957519W/HCE-2	0.73	0.92	1.38	0.9	119
				JHM957540D/JHM957519W	0.73	0.92	1.38	0.9	119
1770	4050	580	770	HM256849D/HM256810	0.34	2	2.98	1.96	56.4
				HM256849D/HM256810-3	0.34	2	2.98	1.96	56.4
3900	8850	460	600	KHH258249TD/KHH258210	0.33	2	3	2	215
2800	4700	500	700	HM258949D/HM258910	0.33	2	3	2	129

Note: * indicates the maximum value of IDor OD.

Double-row Tapered Roller Bearing(Inch DF)

d 305.034~393.7 mm

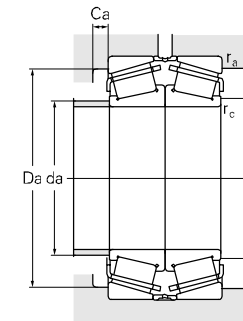
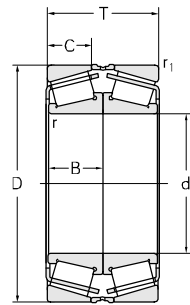
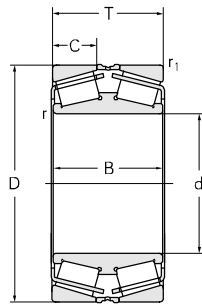

Principal dimensions											
d	D	T	B	C	r _{1min1}	r _{min}					
mm	in	mm	in	mm	in	mm	in	mm	in	mm	mm
305.034	12.009	499.948	19.683	200.025	7.875	200.025	7.875	63.5	2.5	6.4	3.3
		499.948	19.683	200.025	7.875	200.025	7.875	63.5	2.5	6.4	3.3
317.5	12.5	422.275	16.625	128.587	5.062	128.588	5.063	53.975	2.125	3.3	1.5
		447.675	17.625	158.75	6.25	158.75	6.25	53.975	2.125	3.3	1.5
333.375	13.125	469.9	18.5	166.688	6.563	166.688	6.563	71.438	2.813	3.3	3.3
		469.9	18.5	166.688	6.563	166.688	6.563	71.438	2.813	3.3	3.3
		469.9	18.5	166.688	6.563	166.688	6.563	71.438	2.813	3.3	3.3
		469.9	18.5	166.688	6.563	166.688	6.563	71.438	2.813	3.3	3.3
		469.9	18.5	166.688	6.563	166.688	6.563	71.438	2.813	3.3	3.3
		469.9	18.5	166.688	6.563	166.688	6.563	71.438	2.813	3.3	3.3
346.075	13.625	488.95	19.25	174.625	6.875	174.625	6.875	74.612	2.937	3.3	3.3
		488.95	19.25	174.625	6.875	174.625	6.875	74.612	2.937	3.3	3.3
		488.95	19.25	174.625	6.875	174.625	6.875	74.612	2.937	3.3	3.3
		488.95	19.25	174.625	6.875	174.625	6.875	74.612	2.937	3.3	3.3
368.3	14.5	523.875	20.625	185.738	7.313	185.738	7.313	79.375	3.125	6.4	3.3
374.65	14.75	501.65	19.75	130.175	5.125	120.65	4.75	50.8	2	3.3	1.5
380	14.961	567.5	22.343	180	7.087	180	7.087	70	2.756	4	2
384.175	15.125	546.1	21.5	193.675	7.625	193.675	7.625	82.55	3.25	6.4	3.3
		546.1	21.5	193.675	7.625	193.675	7.625	82.55	3.25	6.4	0.8
		546.1	21.5	193.675	7.625	193.675	7.625	82.55	3.25	6.4	3.3
		546.1	21.5	193.675	7.625	193.675	7.625	82.55	3.25	6.4	3.3
390*		570*		180	7.087	180	7.087	63	2.48	4	1.5
390	15.354	567.5	22.343	180	7.087	180	7.087	70	2.756	4	2
		567.5	22.343	180	7.087	180	7.087	70	2.756	4	2
		567.5	22.343	181	7.126	181	7.126	71	2.795	4	2
393.7	15.5	546.1	21.5	138.112	5.437	138.112	5.437	53.975	2.125	6.4	1.5

Basic load ratings		Limit speed ratings		Designations	Calculation coefficient				Weight
C _r	C _{0r}	Grease	Oil		e	Y	Y ₀	a	
kN		r/min							kg
2870	5000	400	500	HM959741DW/HM959710	0.88	0.77	1.15	0.75	149
		460	600	KHM959741DW/KHM959710	0.88	0.77	1.15	0.75	149
1420	3650	490	650	LM258648DW/LM258610/YB2	0.32	2.11	3.15	2.07	49.7
		490	650	HM259049D/HM259010	0.33	2.03	3.02	1.98	80.7
2470	5900	480	630	HM261049D/HM261010	0.33	2	3	2	91.5
		480	630	HM261049D/HM261010-2	0.33	2	3	2	92.8
		480	630	HM261049D/HM261010/YA2	0.33	2	3	2	92.7
		480	630	HM261049D/HM261010/YA2/W281	0.33	2	3	2	92.7
		480	630	HM261049D/HM261010	0.33	2	3	2	92.8
		480	630	KHM261049D/KHM261010	0.33	2	3	2	91.5
2400	5800	480	630	HM262749D/HM262710	0.34	1.99	2.96	1.95	97.8
		480	630	HM262749TD/HM262710/YA10	0.34	1.99	2.96	1.95	100
		480	630	KHM262749D/KHM262710	0.33	2	3	2	97.8
		480	630	KHM262749TD/KHM262710	0.33	2	3	2	97.8
3000	6200	410	540	HM265049DW/HM265010/C9	0.33	2	3	2	128
1600	4000	460	600	KLM765149DW/KLM765110	0.47	1.44	2.14	1.4	69.4
2450	6220	460	600	JM966741DW/JM966711W/ZP	0.73	0.92	1.37	0.9	155
3200	8200	410	540	HM266449D/HM266410	0.33	2.04	3.02	1.98	152
		410	540	HM266449D/HM266410/YAD	0.33	2.03	3.02	1.98	147
		410	540	HM266449DW/HM266410	0.33	2.04	3.02	1.98	151
		410	540	HM266449TD/HM266410	0.33	2.04	3.02	1.98	151
2190	5230	400	520	KJM966748DW/KJM966710	0.83	0.8	1.2	0.8	158
2450	6220	400	520	JM966748D/JM966711/HCEC9YA3-2	0.73	0.92	1.38	0.9	150
		400	520	JM966748DWA/JM966711W/HCE-2	0.73	0.92	1.38	0.9	147
		400	520	JM966748DWA/JM966711W	0.73	0.92	1.38	0.9	147
2150	4650	410	540	LM767745D/LM767710/YB2	0.47	1.42	2.12	1.39	100

Note: * indicates the maximum value of ID or OD.

Double-row Tapered Roller Bearing(Inch DF)

d 406.4~519.112 mm

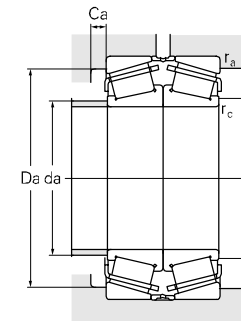
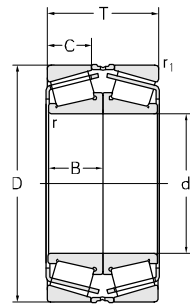
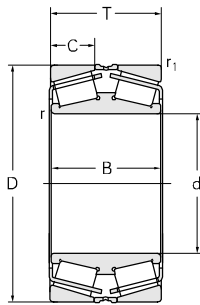

Principal dimensions											
d		D		T		B		C		r _{1min1}	r _{min}
mm	in	mm	in	mm	in	mm	in	mm	in	mm	
406.4	16	590.55	23.25	193.674	7.625	193.675	7.625	80.692	3.177	6.4	3.3
409.575	16.125	546.1	21.5	161.925	6.375	161.925	6.375	66.675	2.625	6.4	1.5
		546.1	21.5	161.925	6.375	161.925	6.375	66.675	2.625	6.4	1.5
		546.1	21.5	161.925	6.375	161.925	6.375	66.675	2.625	6.4	1.5
		546.1	21.5	161.925	6.375	161.925	6.375	66.675	2.625	6.4	1.5
		546.1	21.5	161.925	6.375	161.925	6.375	66.675	2.625	6.4	1.5
		546.1	21.5	161.925	6.375	161.925	6.375	66.675	2.625	6.4	1.5
415.925	16.375	590.55	23.25	209.55	8.25	209.55	8.25	88.9	3.5	6.4	3.3
		590.55	23.25	209.55	8.25	209.55	8.25	88.9	3.5	6.4	3.3
		590.55	23.25	209.55	8.25	209.55	8.25	88.9	3.5	6.4	3.3
		590.55	23.25	209.55	8.25	209.55	8.25	88.9	3.5	6.4	3.3
		590.55	23.25	209.55	8.25	209.55	8.25	88.9	3.5	6.4	3.3
		590.55	23.25	209.55	8.25	209.55	8.25	88.9	3.5	6.4	3.3
431.902	17.004	685.698	26.996	330.2	13	330.2	13	142.875	5.625	6.4	6.4
447.675	17.625	635	25	223.838	8.813	223.838	8.813	95.25	3.75	6.4	3.3
		635	25	223.838	8.813	223.838	8.813	95.25	3.75	6.4	3.3
		635	25	223.838	8.813	223.838	8.813	95.25	3.75	6.4	3.3
		635	25	223.838	8.813	223.838	8.813	95.25	3.75	6.4	3.3
449.948	17.714	594.949	23.423	178	7.008	178	7.008	75	2.953	6	3
479.425	18.875	679.45	26.75	238.125	9.375	238.125	9.375	101.6	4	6.4	3.3*7.5
		679.45	26.75	238.125	9.375	238.125	9.375	101.6	4	6.4	3.3
501.65	19.75	711.2	28	250.825	9.875	250.825	9.875	106.363	4.188	6.4	3.2
505.181	19.889	838.2	33	266.7	10.5	104.775	4.125	104.775	4.125	9.7	6.4
508	20	695.325	27.375	200.025	7.875	200.025	7.875	80.962	3.187	6.4	3.3
	20	762	30	219.075	8.625	219.075	8.625	85.725	3.375	6.4	6.4
519.112	20.437	736.6	29	258.762	10.187	258.762	10.187	111.125	4.375	6.4	3.3

Basic load ratings		Limit speed ratings		Designations	Calculation coefficient				Weight
C _r	C _{0r}	Grease	Oil		e	Y	Y ₀	a	
kN		r/min							kg
3600	7100	410	540	EE833161XD/833232/YB2	0.33	2.03	3.02	1.98	186
2800	6550	410	540	KM667947D/KM667910	0.43	1.6	2.3	1.6	104
2800	8500	410	540	M667947D/M667910	0.43	1.6	2.3	1.6	104
2800	6550	410	540	M667947D/M667910-2	0.43	1.6	2.3	1.6	104
2800	6550	410	540	M667947D/M667910/YA2	0.43	1.6	2.3	1.6	104
2800	6550	410	540	M667947D/M667910/YA2/W281	0.43	1.6	2.3	1.6	104
3900	9600	410	540	M268749DGW/M268710/HEC9YAD	0.33	2	3	2	192
3960	8400	410	540	M268749D/M268710-3	0.33	2.03	3.02	1.98	183
4500	6600	410	540	M268749DWH/M268710S-3/C9	0.33	2.03	3.02	1.98	182
3960	8400	410	540	M268749DW/M268710	0.33	2.03	3.02	1.98	179
4500	6600	410	540	M268749DW/M268710-1/C9	0.33	2.03	3.02	1.98	182
3400	9000	410	540	M268749TD/M268710S/YA10	0.33	2	3	2	195
7100	16000	360	480	EE650171D/650270/C9YA6	0.32	2.12	3.15	2.07	488
3900	10300	360	480	KM270749D/KM270710	0.33	2	3	2	232
3900	10300	360	480	M270749ADW/M270710	0.33	2.03	3.02	1.98	232
3900	10300	360	480	M270749ADW/M270710/ZP	0.33	2.03	3.02	1.98	232
4650	10300	360	480	M270749TD/M270710/C9YB2	0.33	2.03	3.02	1.98	235
2860	7850	360	480	M270449DW/M270410	0.33	2.03	3.02	1.98	147
4500	11900	320	440	KJM272749DA6/KJM272710/YA3-3	0.33	2.03	3.02	1.98	276
4500	11900	320	440	M272749TD/M272710-3	0.33	2.03	3.02	1.98	282
4500	13400	280	360	M274149DGW/M274110/HEC9YAB	0.35	1.92	2.86	1.88	326
5800	12000	280	360	EE426198D/426330/C9	0.48	1.4	2.1	1.4	590
3700	9550	290	380	LM274049DW/LM274010	0.33	2	3	2	225
4650	10200	290	380	KEE531201D/K531300	0.38	1.78	2.09	1.74	347
5200	13300	280	350	M275349D/M275310	0.33	2.03	3.02	1.98	352

Note: * indicates the maximum value of IDor OD.

Double-row Tapered Roller Bearing(Inch DF)

d 519.112~857.25 mm

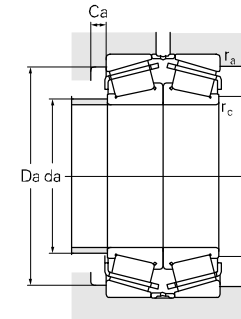
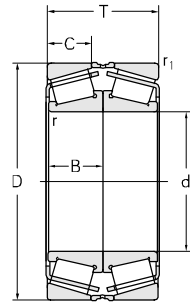
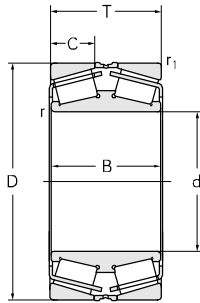

Principal dimensions

d		D		T		B		C		r _{1min}	r _{min}
mm	in	mm	in	mm	in	mm	in	mm	in	mm	mm
519.112		736.6	29	258.762	10.187	258.762	10.187	111.125	4.375	6.4	3.3
		736.6	29	258.762	10.187	258.762	10.187	111.125	4.375	6.4	3.3
536.575		21.125	761.873	29.995	269.875	10.625	269.875	10.625	114.3	4.5	6.4
		761.873	29.995	269.875	10.625	269.875	10.625	114.3	4.5	6.4	3.3
571.5		22.5	812.8	32	285.75	11.25	285.75	11.25	120.65	4.75	6.4
		812.8	32	285.75	11.25	285.75	11.25	120.65	4.75	6.4	3.3
857.25		33.75	1092.2	43	241.3	9.5	241.3	9.5	76.2	3	6.4

Basic load ratings		Limit speed ratings		Designations	Calculation coefficient				Weight
C _r	C _{0r}	Grease	Oil		e	Y	Y ₀	a	
kN		r/min							kg
5200	13300	280	350	M275349D/M275310-3/C9	0.33	2.03	3.02	1.98	352
5200	13300	280	350	M275349D/M275310/W281	0.33	2.03	3.02	1.98	352
5650	16000	280	350	M276449DW/M276410	0.33	2	3	2	400
4500	15000	280	350	M276449DW/M276410/HCRG2	0.33	2.03	3.02	1.98	400
6700	18000	260	330	KM278749DGW/KM278710	0.33	2.03	3.02	1.98	524
7700	18000	260	330	M278749DW/M278710	0.33	2	3	2	524
4710	13100	200	280	EE157337/157430/DF	0.45	1.5	2.24	1.47	499

Double-row Tapered Roller Bearing(Metric DB)

d 40-70 mm

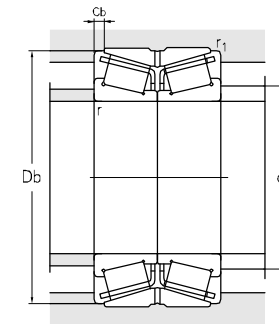
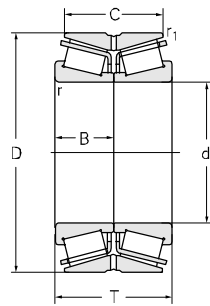
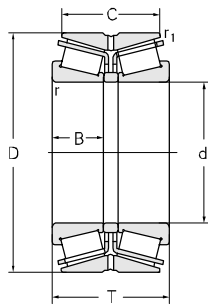

Principal dimensions							Basic load ratings		Limit speed ratings	
d	D	T	B	C	r _{min}	r _{1min}	C _r	C _{or}	Grease	Oil
mm							kN	r/min		
40	70	70	19	64	1	0.3	93.5	152	3600	4800
	70	70	19	64	1	0.3	93.5	152	3600	4800
	73	55	27.5	55	4.2	0.8	90	162	3600	4800
	80	45	22.5	44	2.5	1.5*15*	127	175	3600	4800
45	88	55	27.5	55	5.5	0.4	157	213	3500	4600
50	90	84	32	69	1.5	0.5	200	320	3400	4500
	90	49	20	39	1.8	0.5	111	140	3400	4500
	90	55	23	43.5	1.5	0.6	320	220	3400	4500
	90	55	23	45	1.3	0.5	115	192	3400	4500
55	90	56	56	17.5	3	2	130	243	3300	4400
	90	52	26	41	1.5	0.6	160	245	3300	4400
	90	60	30	60	3.5	0.3	143	279	3300	4400
	100	52	21	42	2	0.5	165	230	3300	4400
	100	52	21	42	2	0.5	165	230	3300	4400
	100	56	25	42.5	2.5	0.5	186	268	3300	4400
	100	56	25	42.5	2.5	0.5	186	268	3300	4400
60	110	52	22	42.5	2	0.5	181	251	2000	3000
	110	52	22	42.5	2	0.5	181	251	2000	3000
63.5	110	68.255	24	61.903	1.5	0.5	174	290	2400	3100
65	100	57.5	57.5	17.5	1.5	0.5	142	256	3400	4500
69.85	126	72	27.5	58.5	1.5	0.3	170	281	3000	4150
	126	72	27.5	58.5	1.5	0.3	170	281	3000	4150
	126	64	27.5	54	2.5	0.4	170	281	3000	4150
	126	64	27.5	54	2.5	0.4	170	281	3000	4150
70	125	71.5	71.5	27	2	0.5	296	460	2400	3200
	125	74	31	61.5	2	0.6	310	495	2400	3200

Designations	Calculation coefficient				Weight kg
	e	Y1	Y2	Yo	
350608/YWG	0.38	1.78	2.65	1.74	0.985
350608/YWG	0.38	1.78	2.65	1.74	0.985
352208X1D1TN1-2RS	0.4	1.69	2.52	1.65	1.04
352208X2D1TN1	0.37	1.82	2.71	1.78	1.04
352209X1D1TN1-2RS	0.4	1.69	2.52	1.65	1.49
33210/C9DBY	0.41	1.65	2.45	1.61	1.75
350210X2	0.42	1.61	2.39	1.57	1.24
352210	0.42	1.61	2.39	1.57	1.39
352210X2	0.42	1.6	2.39	1.57	1.34
32011/DBY	0.41	1.65	2.45	1.61	1.19
352011X2D1	0.41	1.66	2.47	1.62	1.23
352011X2D1TN1-2RS	0.39	1.72	2.56	1.68	1.59
350211X2/C9	0.4	1.67	2.48	1.63	1.60
350211X2/C9	0.4	1.67	2.48	1.63	1.60
352211X2/YA6	0.4	1.67	2.48	1.63	1.87
352211X2/YA6	0.4	1.67	2.48	1.63	1.87
350212X2/C9	0.4	1.69	2.51	1.65	2.01
350212X2/C9	0.4	1.69	2.51	1.65	2.01
3506/63.5R/C9	0.47	1.43	2.12	0.7	2.49
32013T57.5/C9DBY	0.46	1.47	2.18	1.43	1.29
350614X4DR-2	0.58	1.16	1.73	1.13	2.93
350614X4DR-2	0.58	1.16	1.73	1.13	2.93
350614X4DR	0.58	1.18	1.76	1.16	2.59
350614X4DR	0.58	1.18	1.76	1.16	2.59
32214T71.5/C9DBY	0.42	1.61	2.39	1.57	3.41
352214	0.42	1.61	2.39	1.57	3.66

Double-row Tapered Roller Bearing(Metric DB)

d 70-90 mm

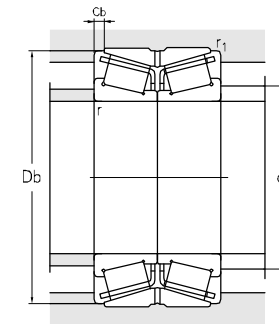
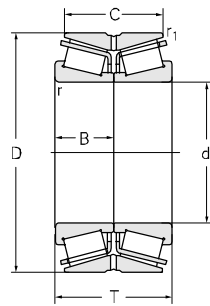
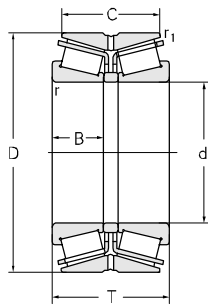

Principal dimensions							Basic load ratings		Limit speed ratings	
d	D	T	B	C	r _{min}	r _{1min}	C _r	C _{or}	Grease	Oil
mm							kN	r/min		
70	125	75	31	62	2	0.6	310	495	2400	3200
	126	71.5	27.5	58.3	1.5	0.3	170	281	2400	3200
	126	71.5	27.5	58.3	1.5	0.3	170	281	2400	3200
	150	83	35	57	3	1	330	450		
71.6	115	74.2	29.5	65.3	1.5	0.3	195	380	2300	2900
75	115	58	25	46	1.5	0.6	178	325	2400	3200
	130	74.5	31	62	1.8	0.3	300	480	2300	3000
76	125.4	62.5	29	65.3	1.5	0.3	203	400	2300	3000
	125.4	56.63	29	59.43	1.5	0.3	203	400	2300	3000
80	125	66	29	52	1.5	0.6	238	430	2200	3000
	129.4	74.2	28.5	65.3	1.5	0.3	205	420	2200	3000
	129.4	74.2	28.5	65.3	1.5	0.3	205	420	2200	3000
	140	80	33	65	2.3	0.7	340	530	2100	2800
85	140	78	33	63.5	2.5	0.6	340	530	2100	2800
	110	46	20	38	1.5	0.3	120	240	2200	3000
	170	94	39	63	3	1	405	560	2000	2600
	150	106	49	82	2.5	0.5	490	825	2000	2700
	150	86	36	69	2.5	0.6	390	620	2000	2700
	150	84	36	66	2.5	0.5	360	630	2000	2700
90	150	82	36	65	2.5	0.6	320	590	2000	2700
	150	85	36.5	66	2.5	0.5	390	620	2000	2700
	180	99	41	66	4	1	560	680	1900	2600
	180	99	41	66	4	1	510	680	1900	2600
	155	85	37.547	63.5	3.5	0.5	330	590	2000	2700
	155	85	37.547	63.5	3.5	0.5	330	590	2000	2700
	160	94	40	78	2.5	0.6	440	525	1900	2500
	160	96	40.8	78	2.5	0.6	440	525	1900	2500
190	103	43	70	4	1	530	760	1700	2200	

Designations	Calculation coefficient				Weight kg
	e	Y1	Y2	Yo	
352214X2	0.42	1.61	2.39	1.57	3.66
350614X4DR-1	0.58	1.18	1.76	1.16	2.93
350614X4DR-1	0.58	1.18	1.76	1.16	2.93
351314	0.83	0.82	1.22	0.8	6.25
3506/71.6R/C9	0.48	1.41	2.09	0.69	2.9
352015	0.46	1.47	2.19	1.44	2.04
352215X2	0.44	1.55	2.31	1.52	3.81
3506/76DR	0.3	2.25	3.43	2.2	2.93
3506/76X2DR	0.3	2.25	3.43	2.2	2.72
352016	0.42	1.61	2.39	1.57	2.76
350616R/C9YA10	0.42	1.61	2.39	1.57	3.10
350616R/C9YA10	0.42	1.61	2.39	1.57	3.10
352216X2	0.4	1.68	2.5	1.64	4.97
352216/YA10	0.42	1.61	2.39	1.57	4.6
352916X3/P5	0.35	1.92	2.86	1.88	1.12
351316	0.4	1.68	2.5	1.64	9.11
33217/DB	0.42	1.61	2.39	1.57	7.58
352217	0.42	1.61	2.39	1.57	5.94
352217X2	0.42	1.61	2.39	1.57	5.59
352217X2-1	0.42	1.61	2.39	1.57	5.52
352217X2-2	0.42	1.61	2.39	1.57	5.96
351317	0.83	0.82	1.22	0.8	11.1
351317/YA10	0.83	0.82	1.22	0.8	11
350618/YA10	0.44	1.55	2.31	1.52	6.12
350618/YA10	0.44	1.55	2.31	1.52	6.12
352218X2	0.42	1.61	2.39	1.57	7.80
352218X2-1	0.42	1.61	2.39	1.57	7.83
351318	0.83	0.82	1.22	0.8	12.3

Double-row Tapered Roller Bearing(Metric DB)

d 95-110 mm

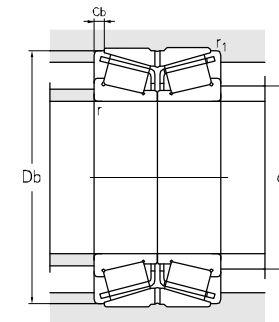
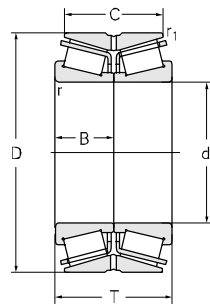
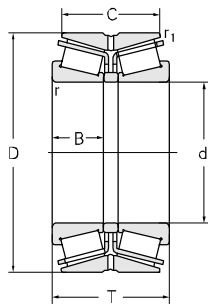

Principal dimensions							Basic load ratings		Limit speed ratings	
d	D	T	B	C	r _{min}	r _{1min}	C _r	C _{or}	Grease	Oil
mm							kN	r/min		
95	170	110	43	93	3	1	535	885	1900	2500
100	140	57	25	47	1.5	0.5	159	335	1500	2000
	150	73	32	57	2	0.6	295	560	1500	2000
	165	112	52	88	2.5	0.5	470	1010	1500	2000
	165	112	52	88	2.5	0.5	470	1010	1500	2000
	175	80	36	60	2.3	0.5	364	634	1500	2000
	180	108	46	88	3	0.8	635	1070	1500	2000
	180	83	34	67	3	1	405	690	1500	2000
	180	111	46	92	3	0.8	670	840	1700	2200
	190	125	62.5	100	3	1.3	630	1050	1500	2000
	190	125	62.5	100	3	1.3	630	1050	1500	2000
	215	280	73	245	4	0.8	1110	1815	1500	2000
	225	124	51	81	4	1	700	1040	1500	2000
105	160	95	43	77	2.5	0.5	410	800	1600	2100
	190	117	50	96	3	0.8	675	1150	1600	2100
	190	118	50	96	3	0.8	670	1210	1600	2100
110	150	80	24	70	1.5	0.5	180	360	1300	1800
	150	80	30	63	0.8	0.3	198	430	1300	1800
	150	80	30	63	0.8	0.3	198	430	1300	1800
	170	86	38	68	2.5	0.6	395	740	1300	1800
	200	122.36	53	102.36	3	0.6	700	1350	1500	2000
	200	92	38	74	3	0.8	560	875	1500	2000
	200	92	46	74	3	3	555	910	1500	2000
	200	92	38	74	3	0.8	560	875	1500	2000
	200	92	46	74	3	3	555	910	1500	2000
	200	124	53	102	3	0.6	680	1150	1500	2000
	200	90	38	72	3	0.8	550	850	1500	2000
	200	125	53.5	102	3	0.6	770	1350	1500	2000
	200	122	53	102	3	1	765	1300	1500	2000

Designations	Calculation coefficient				Weight kg
	e	Y1	Y2	Yo	
32219T110/DBC335	0.42	1.61	2.39	1.57	9.84
352920X3/P5	0.33	2.05	3.05	2	1.95
352020	0.46	1.47	2.19	1.44	4.14
350620/S1YA10	0.41	1.66	2.47	1.63	8.31
350620/S1YA10	0.41	1.66	2.47	1.63	8.31
350620DRTN1	0.39	1.72	2.56	1.68	5.09
32220/DB	0.42	1.61	2.39	1.57	11.1
352220X2	0.42	1.61	2.39	1.57	6.51
352220X2-1	0.42	1.61	2.39	1.57	11.6
350620D1	0.36	1.85	2.76	1.81	14.9
350620D1	0.36	1.85	2.76	1.81	14.9
32320T280/DB	0.35	1.96	2.91	1.91	40.7
351320X1	0.83	0.82	1.22	0.8	21.4
33021/DB	0.28	2.39	3.56	2.34	6.22
352221X2	0.42	1.61	2.39	1.57	13.7
352221X2-1	0.42	1.61	2.39	1.57	13.8
32922X2A/P4ADB	0.28	2.39	3.56	2.34	3.34
350622	0.37	1.82	2.72	1.78	3.61
350622	0.37	1.82	2.72	1.78	3.61
352022	0.43	1.57	2.34	1.53	6.65
32222/DB	0.42	1.61	2.39	1.57	15.7
350222X2	0.42	1.61	2.39	1.57	8.21
350222X2D1/HG2	0.35	1.95	2.9	1.91	11.7
350222X2	0.42	1.61	2.39	1.57	8.21
350222X2D1/HG2	0.35	1.95	2.9	1.91	11.7
352222X2	0.42	1.61	2.39	1.57	16.5
352222X2-1	0.45	1.51	2.25	1.48	11.1
352222X2-2	0.37	1.8	2.7	1.8	16.2
352222X2-3/C9	0.42	1.61	2.39	1.57	16

Double-row Tapered Roller Bearing(Metric DB)

d 115~140 mm

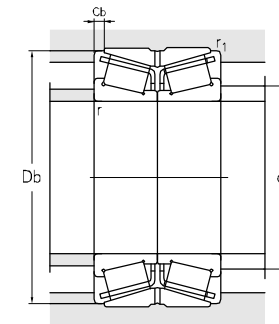
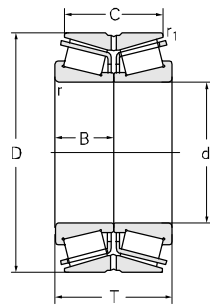
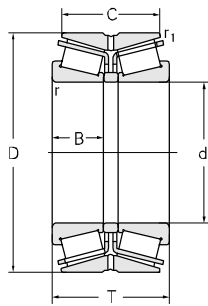

Principal dimensions							Basic load ratings		Limit speed ratings		
d	D	T	B	C	r _{min}	r _{1min}	C _r	C _{or}	Grease	Oil	
mm							kN	r/min			
115	230	116	49.5	84	3	2.5	685	1100	1300	1700	
120	180	88	38	70	2.5	0.6	405	785	1500	2000	
	180	88	88	70	2.5	0.5	430	840	1500	2000	
	215	133	40	114	3	0.8	635	1030	1400	1900	
	215	132	58	109	3	1	770	1390	1400	1900	
	215	132	58	106	3	1	770	1390	1400	1900	
	215	97	41	78	3	1	525	935	1400	1900	
	215	132	58	106	2.5	0.9	770	1390	1400	1900	
	215	129	58	106	3	0.6	885	1570	1400	1900	
	280	185	83.5	155	5	1.5	1410	2250	1100	1500	
130	180	70	30	56	2	0.5	280	565	1400	1900	
	200	95	42	75	2.5	0.7	485	870	1300	1800	
	210	80	35	64	2.5	0.6	455	810	1200	1600	
	214	115.6	48	98	2.3	0.7	605	1070	1300	1700	
	230	145	64	117.5	4	1	890	1760	1300	1700	
	230	149	64	120	4	0.8	980	1760	1300	1700	
	230	149	69	120	4	0.8	870	1660	1200	1650	
	235	145	72.5	115	2.3	1.3	885	1560	1300	1700	
	280	164	66	108	5	1.3	1100	1680	1000	1300	
140	210	100	100	78	2.5	0.5	580	1170	1200	1700	
	210	102	102	80	2.5	0.5	580	1170	1200	1700	
	210	104	45	82	2.5	0.6	580	1170	1200	1700	
	210	104	45	82	2.5	0.6	658	1170	1200	1700	
	210	95	42	75	2.5	0.6	500	950	1200	1700	
		225	100	45	80	2.3	0.7	440	900	1200	1700
		225	100	45	80	2.3	0.7	440	900	1200	1700
		225	115	50	90	2.5	1	640	1180	1200	1700
		240	132	57	106	4	1.5	825	1660	1200	1700

Designations	Calculation coefficient				Weight kg
	e	Y1	Y2	Yo	
350623	0.72	0.94	1.4	0.9	20.2
352024	0.46	1.47	2.19	1.44	7.31
32024T88/DBYAB	0.46	1.47	2.19	1.44	7.23
30224T133/DB	0.44	1.55	2.31	1.52	17.7
352224	0.41	1.64	2.44	1.6	19.2
352224X2	0.41	1.64	2.44	1.6	19.1
352224X2-1	0.42	1.61	2.39	1.57	14.1
352224X2D	0.41	1.64	2.44	1.6	19.6
32224T129/DBYAB	0.44	1.55	2.31	1.52	19.3
350624-1	0.39	1.74	2.59	1.7	54.5
352926X2	0.27	2.49	3.71	2.43	4.87
352026X2	0.35	1.94	2.88	1.89	9.72
352126X2-1	0.39	1.55	2.59	1.7	9.81
352126X2/C9	0.32	2.13	3.17	2.08	15.7
352226/C3					24.0
352226X2	0.44	1.55	2.31	1.52	27.4
352226X2-RS/HCRC9	0.43	1.55	2.31	1.52	26.1
350626D1	0.39	1.74	2.59	1.7	24.7
31326T164/DB	0.83	0.82	1.22	0.8	43.2
32028T100/DBYB2	0.46	1.47	2.18	1.43	12.4
32028T102/DB	0.46	1.47	2.18	1.43	12.5
352028	0.35	1.94	2.88	1.89	11.9
352028/HC	0.35	1.94	2.88	1.89	12.1
352028X2	0.35	1.94	2.88	1.89	8.36
350628DR	0.37	1.8	2.69	1.76	13
350628DR	0.38	1.8	2.69	1.76	13
352128	0.34	2	2.98	1.96	15.5
352228X3	0.44	1.54	2.29	1.5	24.7

Double-row Tapered Roller Bearing(Metric DB)

d 140~160 mm

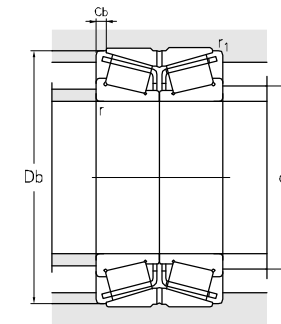
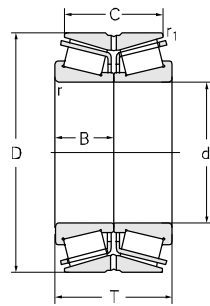
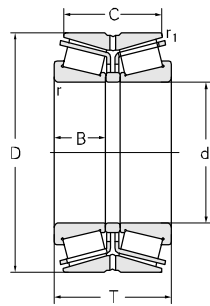

Principal dimensions							Basic load ratings		Limit speed ratings	
d	D	T	B	C	r _{min}	r _{1min}	C _r	C _{or}	Grease	Oil
mm							kN	r/min		
140	250	156.5	68	129	4	1	1150	2080	1200	1600
	250	158	68	130.5	4	1	1040	2080	1200	1600
	250	157	68	128	4	1	1140	2080	1200	1600
	250	106	42	86.5	4	1	635	1030	1200	1600
	300	168	70	108	5	1.1	1280	1970	1000	1200
150	210	80	36	62	2.5	0.7	385	795	1200	1500
	210	80	36	62	2.5	0.7	385	795	1200	1500
	225	79	36	62	2.5	0.7	385	795	1200	1500
	225	112	45	88	3	1	1100	1690	1200	1500
	225	112	45	88	3	1	780	1500	1200	1500
	225	112	45	88	3	1	780	1500	1200	1500
	250	138	60	112	2.5	1	865	1560	1100	1500
	250	80	34	71	3	1	510	860	1200	1500
	255	145	72.5	110	3	1.3	960	1840	1100	1500
	255	145	72.5	110	3	1.3	960	1840	1100	1500
	270	109	45	87	4	1	710	678	1100	1500
	270	109	45	87	4	1	710	678	1100	1500
	270	169	73	138	4	1	1270	2330	1100	1500
	270	164	73	130	4	1	1300	2350	1100	1500
	270	169	73	138	4	1	1270	2330	1100	1500
270	172	74.5	138	4	1	1330	2460	1100	1500	
159	270	150	70	120	2.5	1	960	1720	1100	1500
159.8	270	140	65	120	2.5	1	970	1930	1000	1400
160	160	240	112	51	86	3	715	1450	1100	1500
	220	104	38	88	2.5	0.7	450	1050	1100	1500
	220	90	38	74	2.5	0.7	450	1050	1100	1500
	220	82	36	65	2.5	0.7	415	860	1100	1500
	240	115	48	90	3	0.9	745	1330	1100	1400
240	114	51	84	3	0.6	715	1450	1100	1500	

Designations	Calculation coefficient				Weight kg
	e	Y1	Y2	Yo	
32228T156.5/DB	0.44	1.55	2.31	1.52	31.1
32228T158/DB	0.44	1.55	2.31	1.52	31
352228X2	0.44	1.55	2.31	1.52	31.7
30228T106/DB	0.44	1.55	2.31	1.52	19.8
351328	0.83	0.82	1.22	0.8	51.2
352930X2	0.27	2.48	3.69	2.42	9.32
352930X2D	0.27	2.48	2.69	2.42	9.12
352930X3	0.27	2.48	3.69	2.42	11.8
350630	0.39	1.73	2.58	1.69	14.1
350630/YB2	0.39	1.73	2.58	1.69	14.1
350630/YB2	0.39	1.73	2.58	1.69	14.1
352130	0.25	2.74	4.08	2.68	25.8
352130X2	0.4	1.7	2.53	1.66	15
350630D1	0.44	1.55	2.31	1.52	28.3
350630D1	0.44	1.55	2.31	1.52	28.3
350630-1	0.44	1.55	2.31	1.52	24.5
350630-1	0.44	1.55	2.31	1.52	24.5
352230X2	0.44	1.55	2.31	1.52	39.4
352230	0.44	1.55	2.31	1.52	38.8
352230X2	0.44	1.55	2.31	1.52	39.4
352230X2-1	0.44	1.55	2.31	1.52	39.8
3521/159X2/C3	0.36	1.86	2.76	1.81	28.4
3506/159.8	0.32	2.12	3.15	2.07	31.8
32032T112/DBC345	0.46	1.47	2.19	1.44	16.0
32932/C9DBY	0.35	1.93	2.87	1.89	8.28
32932/P4ADB	0.35	1.95	2.9	1.91	8.52
352932X2	0.27	2.51	3.74	2.45	8.15
352032X2	0.35	1.94	2.88	1.89	16.5
352032X2-1	0.46	1.47	2.19	1.44	16.7

Double-row Tapered Roller Bearing(Metric DB)

d 160~180 mm

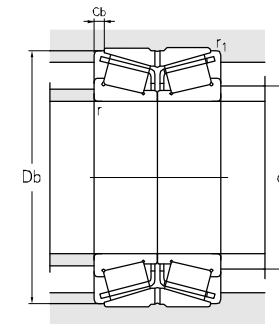
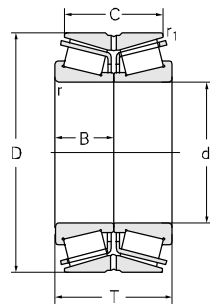
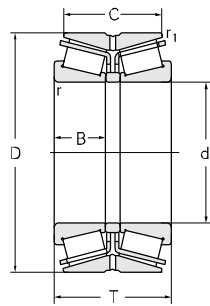

Principal dimensions						Basic load ratings		Limit speed ratings			
d	D	T	B	C	r _{min}	r _{1min}	C _r	C _{or}	Grease	Oil	
mm						kN		r/min			
160	270	140	70	110	2.5	0.9	1720	2610	1000	1400	
	270	140	70	110	2.5	0.9	1720	2610	1000	1400	
	270	150	70	120	2.5	1	965	1720	1000	1400	
	270	140	65	120	2.5	1	970	1930	1000	1400	
	270	150	70	120	2.5	1	965	1720	1000	1400	
	290	178	80	67	4	1	1580	2970	920	1200	
	290	210	80	67	4	1	1580	2970	920	1200	
	290	179	80	67	4	1	1440	2970	920	1200	
	290	178	80	144	4	1	1580	2970	920	1200	
	290	178	80	178	4	1.1	1310	2420	920	1200	
290	180	80	140	3	1.1	1320	2420	920	1200		
165	290	150	70	125	3	1.3	1210	2300	920	1200	
	170	230	82	36	65	2.5	0.7	420	890	1000	1400
		260	120	54	95	3	0.9	755	1550	1000	1300
		260	120	54	95	3	0.9	755	1550	1000	1300
280		150	66	130	2.5	1	1080	2130	950	1300	
280	150	66	120	2.5	1	1070	2000	950	1300		
180	250	95	42	74	2.5	0.7	460	1060	1000	1300	
	250	95	47.5	74	2.5	0.7	520	1300	1000	1300	
	259.5	70	35	70	2.5	1	440	850	1000	1300	
	260	102	45	36	2.5	0.7	605	1450	940	1300	
	270	109.538	47	84.138	2.5	0.6	770	1560	940	1300	
	280	150	63.5	52	3	1	940	1810	940	1300	
	280	142	64	110	3	1	1070	2220	940	1300	
	280	134	60	108	3	0.9	940	1810	940	1300	
	280	130.25	60	108	3	0.9	940	1810	940	1300	
	285	108	54	79.4	2.5	2.3	730	1190	940	1300	
300	164	72	134	3	1	1200	2350	890	1200		
300	120	53.5	96	4	1.5	915	1680	900	1200		
320	196	86	156	5	1.3	1630	3450	890	1200		

Designations	Calculation coefficient				Weight kg
	e	Y1	Y2	Yo	
350632D1	0.36	1.86	2.76	1.81	26.7
350632D1	0.36	1.86	2.76	1.81	26.7
352132X2	0.36	1.86	2.76	1.81	28.3
352132X2/HA	0.32	2.12	3.15	2.07	31.8
352132X2/YB4	0.36	1.86	2.76	1.81	28.3
32232/DBC3	0.44	1.55	2.31	1.52	48.6
32232/DBC3YA10	0.44	1.55	2.31	1.52	53.5
32232T179/DBC230	0.44	1.55	2.31	1.52	48.9
352232	0.44	1.55	2.31	1.52	49.1
352232-2Z	0.4	1.7	2.53	1.66	51.6
352232X2/YA6	0.4	1.7	2.53	1.66	46.2
350633/HCC9	0.31	2.2	3.27	2.15	41.1
352934X2	0.28	2.39	3.56	2.34	8.11
352034X2	0.31	2.18	3.24	2.13	20.4
352034X2D	0.31	2.18	3.24	2.13	20.0
352134-1	0.33	2.02	3	1.97	36.3
352134	0.38	1.78	2.65	1.74	35.6
352936X2	0.37	1.84	2.74	1.8	13.3
352936X2BD1	0.48	1.41	2.09	1.37	13.8
350636D1-1	0.72	0.94	1.4	0.92	11.3
32938X2/DB	0.38	1.76	2.62	1.72	14.4
352936X3	0.37	1.8	2.69	1.76	19.2
32036X2AT150/DBC150	0.28	2.43	3.61	2.37	29.4
352036	0.42	1.61	2.39	1.57	29.8
352036X2	0.28	2.43	3.61	2.37	27.9
352036X2-1	0.28	2.43	3.61	2.37	27.3
350636D1	0.35	1.95	2.9	1.91	23.2
352136	0.26	2.46	3.93	2.58	39.9
352136X2/YA6	0.35	1.95	2.9	1.91	32.4
32236T196/C3DB	0.45	1.5	2.23	1.47	67.5

Double-row Tapered Roller Bearing(Metric DB)

d 180~200 mm

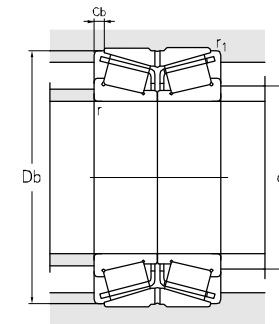
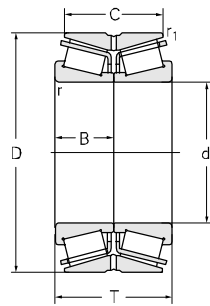
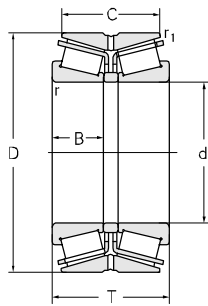

Principal dimensions							Basic load ratings		Limit speed ratings	
d	D	T	B	C	r _{min}	r _{1min}	C _r	C _{or}	Grease	Oil
mm							kN	r/min		
180	320	190	86	145	3.7	1.3	1530	2750	890	1200
	320	192	86	152	5	1.1	1530	2750	890	1200
	340	180	83	140	5	1.1	1700	2860	840	1100
	340	180	83	140	5	2	1620	3100	840	1100
190	260	95	42	75	2.5	0.7	605	1450	940	1300
	290	146	64	48	3	1	1100	2250	890	1200
	290	134	60	104	3	0.9	930	1860	890	1200
	320	170	76	130	3	1	1320	2400	840	1100
	320	172	77	134	3	1	1520	2700	840	1100
	320	172	77	134	3	1	1520	2700	840	1100
	340	204	92	160	5	1.5	1830	3790	800	1000
	200	280	116	51	92	3	1	750	1770	900
280		110	48	85	3	0.9	670	1530	900	1200
280		116	51.5	85	3	1	670	1530	900	1200
280		117	55	97	3	0.6	670	1530	900	1200
280		110	48.5	85	3	1	670	1530	900	1200
280		105	48	85	3	1	685	1570	900	1200
280		112	51	88	3	0.5	785	1870	900	1200
280		112	51	88	3	0.9	785	1870	900	1200
310		154	70	120	3	1	1260	2620	840	1100
310		151	66	120	3	1	995	2080	840	1100
310		151	66	118	3	1	995	2080	840	1100
310		151	66	123	3	1	995	2080	840	1100
310		155	66	56	3	0.8	995	2080	840	1100
310		156	66	128	3	1	995	2080	840	1100
320		110	48.5	85	3	1	890	1560	820	1100
340		112	50.5	100	3	1.5	1070	1850	800	1100
340	112	50.5	100	3	1.5	1070	1850	800	1100	
340	184	82	150	3	1	1810	3400	800	1100	
360	218	174	98	5	1.1	2350	4350	800	1100	
360	218	174	98	5	1.1	2350	4350	800	1100	

Designations	Calculation coefficient				Weight kg
	e	Y1	Y2	Yo	
352236X2/YA6	0.36	1.85	2.76	1.81	52.4
352236/YA6	0.36	1.85	2.76	1.81	60.0
350636	0.35	1.96	2.91	1.91	71.9
350636-1	0.35	1.96	2.91	1.91	71.2
352938X2	0.38	1.76	2.62	1.72	13.3
32038T146/DBC220	0.44	1.53	2.27	1.49	31.6
352038X2	0.37	1.83	2.72	1.79	28.8
352138X2	0.31	2.15	3.2	2.1	52.0
352138X2-1/HCE	0.31	2.15	3.2	2.1	53.2
352138X2-1/HCE	0.31	2.15	3.2	2.1	53.2
352238/YAD	0.44	1.53	2.28	1.5	75.0
352940	0.39	1.72	2.56	1.68	21.0
352940X2	0.39	1.72	2.56	1.68	18.1
352940X2-1	0.39	1.72	2.56	1.68	18.9
352940X2-2	0.39	1.72	2.56	1.68	20.7
352940X2-3	0.39	1.72	2.56	1.68	18.2
352940X2-4	0.39	1.72	2.56	1.68	17.8
352940X2-5/C9	0.39	1.71	2.54	1.67	20.6
32940T112/DB	0.39	1.71	2.54	1.67	20.4
352040	0.43	1.57	2.34	1.53	41.9
352040X2	0.39	1.72	2.56	1.68	38.3
352040X2-1	0.39	1.72	2.56	1.68	38.9
352040X2-2	0.39	1.72	2.56	1.68	38.6
32040X2/DB	0.39	1.72	2.56	1.68	38.9
32040X2T156/DB	0.39	1.72	2.56	1.68	38.9
352940X3/YA10	0.42	1.6	2.38	1.57	30.3
350640	0.25	2.7	4.02	2.64	40.0
350640/C9YA10	0.25	2.74	4.08	2.68	40.0
352140	0.25	2.74	4.08	2.68	63.8
352240/HCYA10	0.41	1.66	2.47	1.62	93.3
352240/YA10	0.41	1.66	2.47	1.62	93.3

Double-row Tapered Roller Bearing(Metric DB)

d 205~240 mm

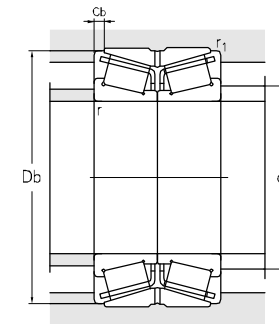
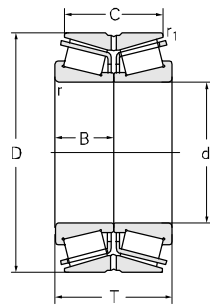
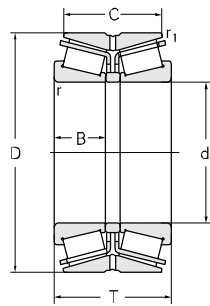

Principal dimensions							Basic load ratings		Limit speed ratings	
d	D	T	B	C	r _{min}	r _{1min}	C _r	C _{or}	Grease	Oil
mm							kN	r/min		
205	320	150	75	110	3.7	1.3	805	1610	940	1100
220	300	110	48	88	3	0.8	705	1720	810	1100
	300	109	47.5	88	3	0.9	730	1825	810	1100
	300	110	48	88	3	0.9	730	1720	810	1100
	340	166	76	128	4	1	1500	3064	750	1000
	340	168	168	130	4	1	1500	3064	750	1000
	340	164	72	130	4	1.1	1370	2730	760	1000
	340	165	72	130	4	1.5	1530	2980	760	1000
	340	113	56.5	90	4	1.5	990	1980	750	1000
	370	195	88	150	4	1.3	1680	3200	760	1000
	370	120	50	107	5	1.5	1130	1910	760	1000
225	360	146.5	73.25	111	3	1.1	1280	2290	760	1000
228.6	488.92	345	150	220	5	1.5	3320	5890	710	900
230	355	145	72.5	110	6	2.3	1180	2310	760	1000
240	320	104	48	82	3	1	675	1550	760	1000
	320	110	48	87	3	1	665	1590	760	1000
	320	110	48	87	3	0.9	665	1590	760	1000
	320	109	48	90	3	1	675	1550	760	1000
	320	105	48.5	82	3	1	675	1550	760	1000
	320	119	119	39	3	0.8	875	2090	760	1000
	320	120	48	100	3	0.8	675	1590	760	1000
	360	172	76	134	4	1	1330	3150	690	920
	360	171	72	62	4	1.1	1350	2900	690	920
	360	170	72	143	4	1.1	1350	2900	690	920
360	165	72	130	4	1.1	1460	2890	690	920	
360	165	72	130	4	1.1	1400	3050	690	920	

Designations	Calculation coefficient				Weight kg
	e	Y1	Y2	Yo	
351041X2D1	0.39	1.72	2.56	1.68	40.2
352944X2	0.31	2.18	3.24	2.13	21.2
352944X2-1	0.31	2.18	3.24	2.13	20.8
352944X2-SMJ	0.31	2.18	3.24	2.13	21.8
32044T166/DBC340	0.43	1.57	2.34	1.53	51.3
32044T168/DB	0.43	1.6	2.3	1.6	50.8
352044X2	0.35	1.95	2.9	1.91	47.7
352044X2-1	0.35	1.95	2.9	1.91	47.9
352044X2D1/YAB	0.36	1.88	2.79	1.83	34.5
352144	0.37	1.83	2.72	1.79	76.3
350644	0.37	1.83	2.72	1.79	46.9
350645D1	0.36	1.87	2.79	1.83	48.2
3506/228X4	0.87	0.78	1.16	0.76	286
350646D1	0.36	1.87	2.79	1.83	
352948X2	0.32	2.12	3.15	2.07	23.6
352948X2-1	0.32	2.12	3.15	2.07	23.2
352948X2-1/YA1W	0.32	2.12	3.15	2.07	23.0
352948X2-2	0.32	2.12	3.15	2.07	23.5
352948X2-3	0.32	2.12	3.15	2.07	22.4
32948T119/C9DBY	0.46	1.47	2.18	1.43	15.2
32948X2AT120/C3DB	0.32	2.12	3.15	2.07	24.5
32048T172/C3DB	0.46	1.47	2.19	1.44	56.9
32048X2AT171/DBCR275	0.31	2.15	3.2	2.1	52.7
32048X2T170/DB	0.31	2.15	3.2	2.1	55.5
352048X2	0.31	2.15	3.2	2.1	52.8
352048X2/HC-XRBL	0.31	2.15	3.2	2.1	53.2

Double-row Tapered Roller Bearing(Metric DB)

d 240~280 mm

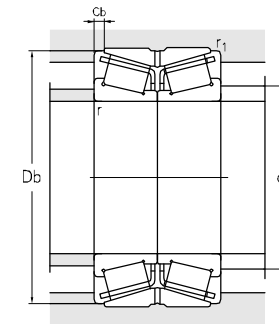
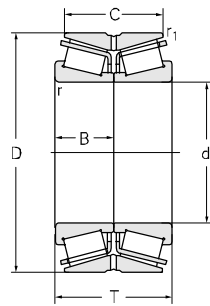
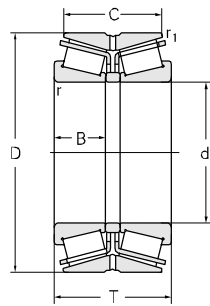

Principal dimensions						Basic load ratings		Limit speed ratings		
d	D	T	B	C	r _{min}	r _{1min}	C _r	C _{or}	Grease	Oil
mm						kN		r/min		
240	400	128	59	114	5	1.5	1240	2270	720	1000
	400	160	71	128	5	1.5	1670	3200	720	1000
	400	210	95	163	3.7	1.3	2060	4050	630	840
	400	210	95	168	4	1	1870	4050	630	840
	420	205	205	69.5	5	1.3	2550	4100	700	950
	440	270	120	216	5	1.3	3200	6300	680	930
	440	294	120	240	5	1.3	3300	6500	680	930
242	406	206	92	162	4	1	2680	5000	670	900
	406	206	97	162	6.4	1.5	2900	5000	670	900
260	360	147	60	124	3	0.9	1080	2620	670	900
	360	141	63.5	110	3	1	1120	2550	670	900
	360	134	60	108	3	0.9	1010	2500	670	900
	360	133	60	109	3	1.1	1010	2500	670	900
	360	134	60	108	3	1	1300	2600	670	900
	360	134	60	108	3	1	1000	2600	670	900
	360	92	40	62	3	1	630	1370	700	950
	360	134	60.5	108	3	1	1040	2550	670	900
	400	186	82	146	5	1.3	1750	3750	630	840
	400	150	75	110	4.7	1.1	1400	2630	630	840
	400	130	57	104	5	1.5	1250	2590	630	840
	400	155	72	108	9.5	1.6	1400	2630	630	840
	400	186	82	146	5	1.5	1850	4100	630	840
	430	180	90	130	7.5	2.3	1560	2990	630	840
440	225	100	180	4	2.3	2410	4750	580	770	
480	284	130	220	6	1.5	3800	7600	580	700	
480	282	282	102.5	6.4	1.6	3700	7300	520	680	
480	282	282	102.5	6.4	1.6	4500	7700	520	680	
280	380	140	60	50	3	0.9	1100	2770	620	820
	380	134	60	108	3	0.9	1030	2650	620	820
	380	134	60	108	3	1	1030	2650	620	820
	380	141	63.5	110	3	1	1250	3100	620	820

Designations	Calculation coefficient				Weight
	e	Y1	Y2	Yo	
kg					
350648	0.43	1.55	2.31	1.52	60
350648/HC-1	0.39	1.74	2.59	1.7	81.2
352148	0.31	2.18	3.24	2.13	98.1
352148X2	0.31	2.18	3.24	2.13	98.5
30648/HCC9DBY	0.44	1.53	2.28	1.5	105
32248/HCC9DBYAB	0.44	1.53	2.28	1.5	168
32248/HCDB	0.44	1.55	2.31	1.52	184
306/242/HCC9/DB	0.43	1.57	2.34	0.77	101
306/242/HCEDBYB2	0.33	2.03	3.02	0.99	98
32952X2AT147/C3DB	0.3	2.23	3.32	2.18	43
352952	0.41	1.66	2.47	1.62	39.0
352952X2	0.3	2.23	3.32	2.18	39.7
352952X2-1	0.3	2.23	3.32	2.18	39.8
352952X2-2/HC	0.3	2.23	3.32	2.18	37.5
352952X2-2/YB2	0.41	1.66	2.47	1.62	37.5
352952X2-3	0.7	0.96	1.44	0.94	25.5
352952X2-3/YB2	0.29	2.23	3.32	2.18	38.3
352052X2	0.29	2.31	3.45	2.26	79.3
352052X2-1	0.29	2.31	3.45	2.26	60.3
352052X2-2/C3	0.29	2.31	3.45	2.26	53.9
352052X2-3	0.35	1.95	2.99	1.91	62.2
352052X2/HCYAD-XRBL	0.43	1.57	2.34	1.53	80.7
350652D1	0.35	1.95	2.9	1.91	87.9
352152X2/YA6	0.24	2.84	4.23	2.78	124
352252	0.43	1.57	2.34	1.53	216
32252X2/DBYB2	0.43	1.6	2.3	1.6	210
32252X2/HCDBYB2	0.33	2.05	3.05	2	208
32956X2A/P4DB	0.32	2.1	3.13	2.05	46.3
352956X2	0.32	2.1	3.13	2.05	44.0
352956X2/P5	0.32	2.1	3.13	2.05	44.0
352956/YA10	0.43	1.6	2.3	1.6	43.2

Double-row Tapered Roller Bearing(Metric DB)

d 280~300 mm

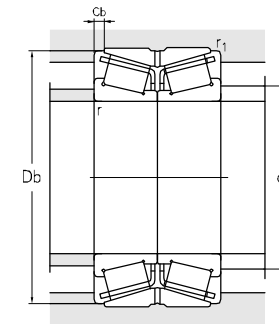
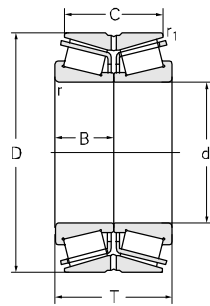
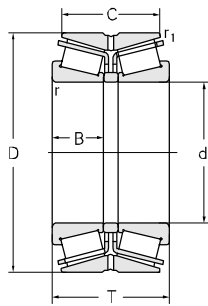

Principal dimensions						Basic load ratings		Limit speed ratings			
d	D	T	B	C	r _{min}	r _{1min}	C _r	C _{or}	Grease	Oil	
mm						kN		r/min			
280	420	186	82	146	5	1.3	1890	4000	580	770	
	420	188	83	154	5	1.3	1890	4000	580	770	
	420	189	83.5	154	5	1.3	1960	4200	580	770	
	420	196	87	152	4	1.1	2000	4400	580	770	
	460	185	82	140	5	1.5	2130	4050	580	770	
	460	146	65	130	6	2	1810	3300	580	770	
	470	250		180	6.4	1.5	3430	6300	500	650	
	300	400	140	62	100	5	1.5	1450	3000	560	740
		400	140	62	100	5	1.5	1450	3000	560	740
		420	175	72	147	4	1.1	1510	3620	580	770
420		160	72	128	4	1	1510	3620	580	770	
420		159	71.5	128	4	1.1	1820	3610	580	770	
420		159	71.5	128	4	1.1	1820	3610	580	770	
420		160	72	128	4	1	1510	3620	580	770	
420		160	72	128	4	1	1510	3620	580	770	
420		160	72	128	4	1.1	1900	4100	580	770	
420		160	72	128	4	1.1	1670	3614	580	770	
460		210	95	165	5	1.3	2240	4800	560	740	
460		210	95	165	5	1.3	2240	4800	560	740	
460		210	95	165	5	1.3	2850	5300	560	740	
500		200	90	160	6	3	2300	4450	530	710	
500		203	91	152	5	1.5	3000	4950	530	710	
500		203	91	152	5	1.5	3000	4950	530	710	
500		203	91	152	5	1.5	2850	5050	530	710	
500		205	90	152	5	1.5	2400	4450	530	710	
500		205	90	152	5	1.5	2400	4450	530	710	
500		205	90	152	6	2.5	2400	4450	530	710	
500	205	90	152	6	2.5	2400	4450	530	710		
320	440	195	72	62	4	1	1650	3900	530	710	
	440	195	195		4	1	1650	3900	530	710	

Designations	Calculation coefficient				Weight
	e	Y1	Y2	Yo	
kg					
352056X2	0.37	1.83	2.72	1.79	81.5
352056X2-1	0.37	1.83	2.72	1.79	82.7
352056X2-2	0.35	1.95	2.99	1.91	82.9
32056/DB	0.46	1.47	2.19	1.44	88.8
351156	0.33	2.05	3.05	2	114
351156X2/YA6	0.4	1.68	2.5	1.64	88.8
350656	0.46	1.5	2.2	1.4	156
350660/C9	0.88	0.77	1.15	0.8	63.2
350660/C9	0.88	0.77	1.15	0.8	63.2
32960X2AT175/C3DB	0.28	2.39	3.56	2.34	67.6
352960X2A	0.28	2.39	3.56	2.34	60.8
352960X2A-1/HCE	0.28	2.39	3.56	2.34	63.6
352960X2A-1/HCYA10	0.28	2.39	3.56	2.34	63.5
352960X2A/P5	0.28	2.39	3.56	2.34	60.8
352960X2A/P6	0.28	2.39	3.56	2.34	60.9
352960X2/HCR-1	0.28	2.39	3.56	2.34	63.9
352960X2/P6	0.28	2.39	3.56	2.34	60.8
352060X2	0.36	1.85	2.76	1.81	118
352060X2/HC	0.36	1.85	2.76	1.81	118
352060X2/HC-XRBL	0.36	1.85	2.76	1.81	117
351160X2	0.32	2.12	3.15	2.07	142
351160X2-1/HCE	0.4	1.68	2.5	1.64	148
351160X2-1/HC-XRBL	0.4	1.68	2.5	1.64	146
351160X2-1/HC-XRBL-1	0.4	1.68	2.5	1.64	140
351160	0.32	2.12	3.15	2.077	141
351160/HAC3	0.32	2.12	3.15	2.077	141
351160/HCYAD	0.32	2.12	3.15	2.07	141
351160/YA6	0.32	2.12	3.15	2.07	141
32964X2AT195/DBCR375	0.31	2.15	3.21	2.11	77.5
32964X2T195/DB	0.31	2.15	3.21	2.11	77.7

Double-row Tapered Roller Bearing(Metric DB)

d 320~380 mm

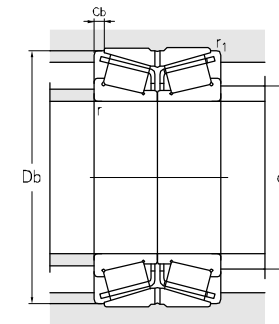
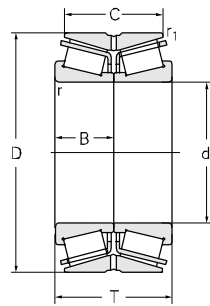
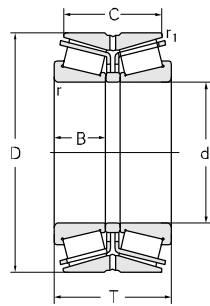

Principal dimensions							Basic load ratings		Limit speed ratings	
d	D	T	B	C	r _{min}	r _{1min}	C _r	C _{or}	Grease	Oil
mm							kN	r/min		
320	440	160	72	128	4	1	1650	3900	530	710
	440	160	72	128	4	1	1650	3900	530	710
480	151	66.5	121	5	1.5	1870	3550	530	710	
	151	66.5	121	5	1.5	2090	3500	530	710	
	151	66.5	121	5	1.5	1870	3550	530	710	
	220	100	186	5	1.1	2540	5750	530	710	
480	210	95	160	5	1.1	2310	5750	530	710	
	215	100	163	5	1.1	2500	5700	530	710	
	225	100	160	5	1.5	3100	5700	510	660	
540	225	100	160	5	1.5	3100	5700	510	660	
	164	164	63	4	1	1500	4050	500	660	
340	166	75	128	4	1.1	1540	4050	500	660	
	160	72	128	4	1.1	1540	4050	500	660	
	160	72	128	4	1.5	1600	4000	500	660	
	180	82	135	5	1.5	2060	4100	480	640	
520	165	82.5	133	6	2	2550	4600	480	640	
	242	106	170	5	1.5	3100	6000	460	620	
	238	107	190	6	2	3350	6600	370	500	
	160	72	128	4	1	1640	2240	510	680	
360	185	82	140	5	1.5	2880	6300	460	620	
	185	82	140	5	1.5	2880	6300	460	620	
	169	70	134	6	2	2180	4400	460	620	
600	242	106	170	5	1.5	3410	6800	400	520	
	242	106	170	5	1.5	3410	6800	400	520	
380	145	65	105	4	1.1	1660	3800	530	710	
	149	65	112	4	1.1	1660	3800	530	710	
	190	82	140	5	1.5	2880	6300	410	540	

Designations	Calculation coefficient				Weight kg
	e	Y1	Y2	Yo	
352964X2	0.31	2.15	3.21	2.11	67.4
352964X2-1	0.31	2.15	3.21	2.11	67.4
350664	0.32	2.08	3.1	2.04	88.9
350664/HCE	0.32	2.08	3.1	2.04	88.9
350664	0.32	2.08	3.1	2.04	88.9
350664/HCE	0.32	2.08	3.1	2.04	88.9
352064	0.46	1.47	2.19	1.44	134
352064X2	0.46	1.47	2.19	1.44	124
352064X2-1	0.46	1.47	2.19	1.44	129
351164	0.4	1.68	2.5	1.64	181
351164	0.4	1.68	2.5	1.64	181
32968X2A/P5DB	0.41	1.65	2.45	1.61	70.1
352968	0.31	2.15	3.2	2.1	72.3
352968X2	0.31	2.15	3.2	2.1	71.0
352968X2/HG2	0.4	1.68	2.5	1.64	70.5
351068	0.29	2.35	3.5	2.3	127
351068X2D1/HC	0.39	1.73	2.58	1.69	117
351168	0.42	1.6	2.38	1.56	235
351168X2	0.4	1.68	2.5	1.64	237
352972X2	0.33	2.05	3.05	2	74.7
351072	0.37	1.82	2.7	1.78	120
351072/HCE-CB	0.37	1.82	2.7	1.78	120
351072X2	0.37	1.82	2.7	1.78	122
351172	0.44	0.54	2.3	1.51	221
351172/HC	0.44	0.54	2.3	1.51	221
351976	0.38	1.77	2.64	1.73	78.8
351976X2	0.38	1.77	2.64	1.73	82.4
351076	0.39	1.75	2.61	1.71	137

Double-row Tapered Roller Bearing(Metric DB)

d 380~460 mm

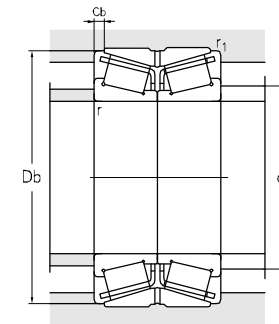
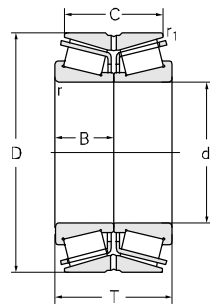
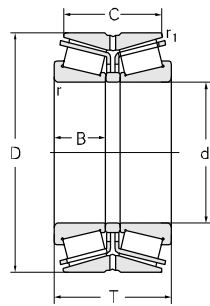

Principal dimensions							Basic load ratings		Limit speed ratings	
d	D	T	B	C	r _{min}	r _{1min}	C _r	C _{or}	Grease	Oil
mm							kN	r/min		
380	560	190	82	140	5	1.5	2880	6300	410	540
	620	242	106	170	5	1.5	3410	6850	410	540
400	540	150	65	105	4	1.1	1650	3850	530	710
	540	150	65	105	4	1.1	1650	3850	530	710
	540	145	65	100	4	1.1	1650	3850	530	710
	600	206	90	150	5	1.5	2890	6300	410	540
	600	206	90	150	6	2	2890	6300	410	540
	600	185	80	148	6	2	2700	5850	410	540
	600	206	90	150	5	1.5	2890	6300	410	540
	600	206	90	150	6	2	2890	6300	410	540
	600	230	100	178	5	1.5	3350	7600	410	540
	600	185	80	148	6	2	2700	5850	410	540
	650	255	112	180	6	2.5	3630	7400	360	480
420	560	145	65	105	4	1.1	1880	4450	360	480
	620	206	90	150	5	1.5	2670	5880	360	480
	620	206	90	150	5	1.5	2670	5880	360	480
	620	188	86	150	6	2	2840	6210	360	480
	620	190	95	125	5	1	2620	5300	360	480
	700	275	122	200	6	2.5	4430	9150	360	480
440	600	170	74	125	4	1.1	2300	5300	400	520
	600	170	74	125	4	1.1	2300	5300	400	520
	650	212	94	152	6	2.5	3150	6900	360	480
	720	275	122	190	6	2.5	4950	10400	360	480
	720	283	131.5	226	6	2.5	5200	11000	360	480
460	620	174	74	130	4	1	1960	5150	400	520
	620	174	74	130	4	1.1	1960	5150	400	520
	680	230	100	175	6	2.5	3410	7450	360	480
	680	204	94	163	3	3	3400	7650	360	480

Designations	Calculation coefficient				Weight kg
	e	Y1	Y2	Yo	
351076/HCERP6XHC9	0.39	1.75	2.61	1.71	137
351176	0.46	1.47	2.18	1.43	250
351980/HC	0.45	1.5	2.23	1.47	84.5
351980/P5	0.45	1.5	2.23	1.47	84.6
351980X2/P5	0.45	1.5	2.23	1.47	82.5
351080/HAC3	0.38	1.78	2.65	1.74	179
351080/HCYAD	0.38	1.78	2.65	1.74	179
351080X2-2/C9	0.37	1.82	2.72	1.78	169
351080/HAC3	0.38	1.78	2.65	1.74	179
351080/HCYAD	0.38	1.78	2.65	1.74	179
351080X2	0.37	1.82	2.72	1.78	203
351080X2-1	0.37	1.82	2.72	1.78	168
351180	0.41	1.66	2.47	1.63	279
351984	0.38	1.77	2.64	1.73	87.0
351084	0.41	1.64	2.44	1.6	191
351084/HC	0.41	1.64	2.44	1.6	191
351084X2-1/HC	0.39	1.74	2.59	1.7	178
351084X2D1	0.41	1.63	2.43	1.6	166
351184J	0.32	2.12	3.15	2.07	376
351988	0.39	1.73	2.58	1.69	123
351988/HG2	0.39	1.73	2.58	1.69	123
351088	0.44	1.52	2.26	1.49	212
351188	0.46	1.48	2.2	1.44	404
351188X2/HCYB2	0.39	1.74	2.59	1.7	426
351992	0.4	1.69	2.51	1.65	134
351992/HC	0.4	1.69	2.51	1.65	134
351092	0.31	2.18	3.24	2.13	253
351092X2/HCP5YA6	0.4	1.68	2.5	1.64	236

Double-row Tapered Roller Bearing(Metric DB)

d 460~560 mm

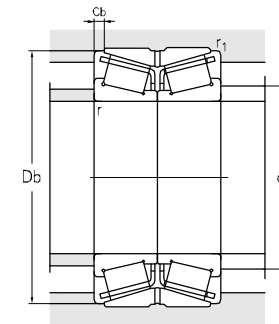
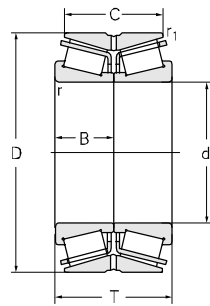
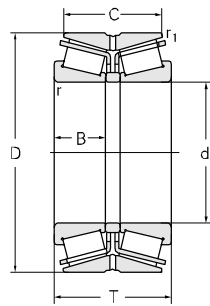

Principal dimensions							Basic load ratings		Limit speed ratings		
d	D	T	B	C	r _{min}	r _{1min}	C _r	C _{or}	Grease	Oil	
mm							kN	r/min			
460	760	300	135	240	7.5	4	5150	11900	350	440	
	760	300	135	240	7.5	4	5900	12700	350	440	
480	650	180	78	130	5	1.5	2150	5150	360	480	
	650	180	78	130	5	1.5	2150	5150	360	480	
	700	240	100	180	6	2.5	3100	8200	250	320	
	700	206	93	165	6	3	3100	6700	250	320	
	700	275	122	200	6	3	4150	9500	250	320	
	720	236	100	180	6	2.5	4200	8300	250	320	
	790	310	136	224	7.5	3	6200	13300	250	320	
500	670	180	78	130	5	1.5	1340	6200	350	460	
	670	180	78	130	5	1.5	1470	6200	350	460	
	670	180	78	130	5	1.5	2360	6700	350	460	
	720	236	100	180	6	2.5	3580	8150	410	540	
	720	236	118	180	6	2.5	3750	8500	410	540	
	720	236	100	180	6	2.5	4200	8300	410	540	
	720	209	94	167	6	3	3250	7700	410	540	
530	710	190	82	136	5	1.5	2670	6300	320	420	
	710	190	82	136	6	2.5	2670	6300	320	420	
	780	255	112	180	6	2.5	4350	9850	320	420	
	780	255	112	180	6	2.5	4350	9850	320	420	
	780	231	106.5	185	3	3	4650	10700	320	420	
539.75	635	120.65	50.8	95.25	6.4	1.5	1190	4000	360	460	
560	735	225	100	180	6.4	1.5	3500	9700	330	420	
	750	213	85	156	5	1.5	3410	8500	310	410	
	750	213	85	156	5	1.5	3780	8500	310	410	
	750	213	85	156	5	1.5	3780	8500	310	410	
	820	260	115	185	6	2.5	2920	5700	310	410	
	820	260	115	185	6	2.5	5000	11500	310	410	
	820	340	155	270	8	2.5	6200	17200	310	410	

Designations	Calculation coefficient				Weight
	e	Y1	Y2	Yo	
kg					
350692/C9	0.45	1.5	2.23	1.47	516
350692/HCYA8	0.45	1.5	2.23	1.47	539
351996	0.42	1.61	2.4	1.58	159
351996/HC	0.42	1.61	2.4	1.58	159
351096	0.41	1.66	2.47	1.62	272
351096X2-1/HC	0.37	1.83	2.72	1.78	232
351096X2/HCC9	0.36	1.87	2.79	1.83	309
351096X3/HC-TS	0.32	2.11	3.14	2.06	303
351196	0.39	1.73	2.58	1.69	540
3519/500	0.43	1.55	2.31	1.52	158
3519/500/HC	0.43	1.55	2.31	1.52	158
3519/500/HCYA5	0.43	1.55	2.31	1.52	156
3510/500	0.32	2.08	3.1	2.04	276
3510/500D	0.32	2.08	3.1	2.04	276
3510/500/HCE	0.32	2.08	3.1	2.04	274
3510/500X2	0.37	1.83	2.72	1.78	256
3519/530	0.39	1.73	2.57	1.69	176
3519/530/YA6	0.39	1.73	2.57	1.69	176
3510/530	0.34	2	2.97	1.95	371
3510/530/HCR	0.34	2	2.97	1.95	371
3510/530X2/HCP5YA6	0.37	1.82	2.71	1.78	356
3506/539X4/HC	0.41	1.64	2.45	1.6	62.2
3506/560/HC	0.35	1.95	2.9	1.9	235
3519/560	0.43	1.57	2.34	1.53	232
3519/560/HC	0.43	1.57	2.34	1.53	232
3519/560/HCCNH	0.43	1.57	2.34	1.53	232
3510/560	0.4	1.7	2.54	1.67	434
3510/560/HC	0.4	1.7	2.54	1.67	449
3510/560X2/YA6	0.32	2.14	3.18	2.09	741

Double-row Tapered Roller Bearing(Metric DB)

d 600~950 mm

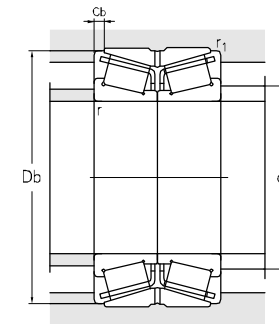
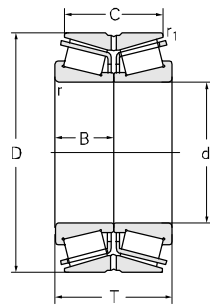
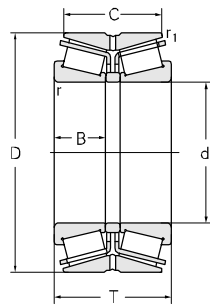

Principal dimensions							Basic load ratings		Limit speed ratings	
d	D	T	B	C	r _{min}	r _{1min}	C _r	C _{or}	Grease	Oil
mm							kN	r/min		
600	800	205	90	156	5	1.5	3410	9050	290	390
	800	205	90	156	5	1.5	3450	9600	290	390
	800	208	90	160	6	2.5	3400	9050	290	390
	870	270	118	198	6	2.5	5390	12700	280	380
	870	270	118	198	6	2.5	5390	12700	280	380
	870	250	110	200	3	3	5250	12400	280	380
630	920	265	114.5	212	7.5	4	7000	14000	270	350
670	900	240	103	180	6	2.5	4200	11200	260	350
	980	310	136	215	7.5	3	6300	15100	260	330
710	950	240	106	175	6	2.5	4730	13200	250	320
720	915	190	83	140	6	2.5	3000	10000	260	330
750	1000	264	112	194	6	2.5	5340	15600	230	310
	1000	264	112	194	6	2.5	4900	15100	230	310
	1000	264	112	194	6	2.5	5400	15100	230	310
	1000	255	112	190	6	2.5	5390	15100	230	310
	1000	255	112	190	6	2.5	5390	15100	230	310
	1000	255	112	190	6	2.5	5390	15100	230	310
800	1060	270	115	204	6	2.5	6870	15200	220	300
	1060	270	115	204	6	2.5	6250	15200	220	300
	1060	270	115	204	6	2.5	6250	15200	220	300
850	1120	268	118	188	6	2.5	6850	18700	210	270
	1120	268	118	190	6	2.5	6250	18700	210	270
	1220	272	116	239	7.5	4	7600	17700	200	260
900	1180	275	122	205	6	2.5	7640	21300	200	260
950	1250	300	132	220	7.5	3	7870	22500	180	240
	1280	280	120	246	7.5	4	8300	22200	170	220

Designations	Calculation coefficient				Weight kg
	e	Y1	Y2	Yo	
3519/600	0.33	2.05	3.05	2	247
3519/600/YAD	0.33	2.05	3.05	2	264
3519/600X2	0.33	2.05	3.05	2	252
3510/600	0.41	1.63	2.43	1.6	517
3510/600/HCR	0.41	1.63	2.43	1.6	517
3510/600X2/HC	0.39	1.73	2.57	1.69	454
3510/630X2/HC	0.36	1.87	2.79	1.83	570
3519/670	0.44	1.53	2.28	1.5	378
3510/670	0.37	1.83	2.73	1.79	714
3519/710	0.46	1.47	2.19	1.44	445
3506/720	0.38	1.75	2.61	1.72	284
3519/750	0.45	1.5	2.24	1.47	546
3519/750/HG	0.45	1.5	2.24	1.47	546
3519/750-JG	0.45	1.5	2.24	1.47	542
3519/750X2	0.45	1.5	2.24	1.47	535
3519/750X2/HC	0.45	1.5	2.24	1.47	535
3519/750X2/HCYA10	0.45	1.5	2.24	1.47	535
3519/800	0.35	1.93	2.87	1.88	606
3519/800/HC	0.35	1.93	2.87	1.88	607
3519/800/HCR	0.35	1.93	2.87	1.88	607
3519/850	0.46	1.46	2.18	1.43	645
3519/850X2	0.46	1.46	2.18	1.43	647
3510/850X2/HCYA6	0.37	1.83	2.72	1.79	1000
3519/900	0.37	1.8	2.69	1.76	763
3519/950	0.33	2.05	3.05	2	897
3506/950	0.4	1.68	2.5	1.64	974

Double-row Tapered Roller Bearing(Metric DB)

d 1092.2~1600 mm

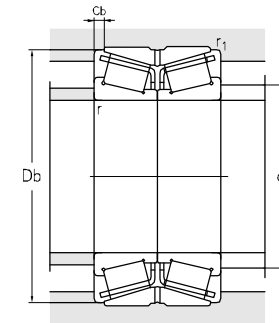
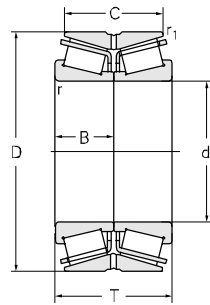
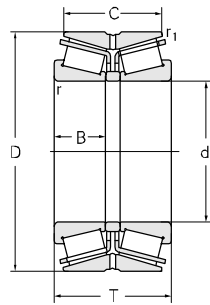

Principal dimensions							Basic load ratings		Limit speed ratings	
d	D	T	B	C	r _{min}	r _{1min}	C _r	C _{or}	Grease	Oil
mm							kN	r/min		
1092.2	1320.8	200	87.5	145	6.4	3.5	5050	16900	170	220
1120	1460	335	158	250	7.5	3	9900	29500	160	210
1180	1600	390	170	250	7.5	4	10500	33700	150	190
1250	1500	250	112	190	6	1.5	7150	24200	100	140
1370	1605	210	96	150	7.5	4	5150	20700	60	75
1450	1770	290	115	170	9.5	5	7780	25800	80	120
1600	1850	200	90	150	6	6	5610	20700	50	65

Designations	Calculation coefficient				Weight kg
	e	Y1	Y2	Yo	
3506/1092X4/HC	0.57	1.18	1.76	1.16	514
3519/1120	0.35	1.93	2.87	1.88	1350
3506/1180	0.7	0.97	1.44	0.94	2100
3506/1250/YA1	0.35	1.9	2.9	1.8	795
3506/1370	0.4	1.68	2.5	1.64	673
3506/1450/HC	0.87	0.78	1.16	0.76	1317
3506/1600/C9	0.32	2.12	3.15	2.08	800

Double-row Tapered Roller Bearing(Inch DB)

d 34.925~101.6 mm

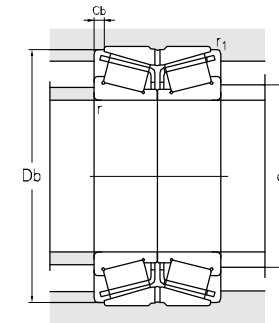
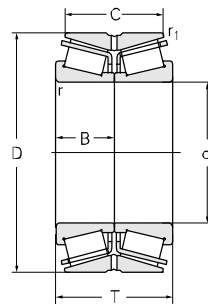
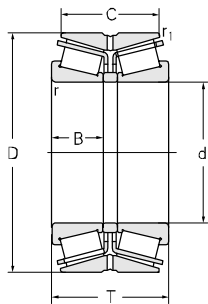

Principal dimensions

d	D	T	B	C	r _{1min1}	r _{min}					
mm	in	mm	in	mm	in	mm					
34.925	1.375	65.088	2.563	39.624	1.56	18.288	0.72	31.496	1.24	0.3	4.7
38.1	1.5	80.035	3.151	57.15	2.25	23.698	0.933	44.958	1.77	0.8	0.8
40	1.575	80.035	3.151	46.04	1.813	20.94	0.824	34.925	1.375	0.8	1.5
50.8	2	82.55	3.25	51.766	2.038	25.883	1.019	41.606	1.638	0.5	3.5
52.388	2.063	112.712	4.437	65.088	2.563	26.909	1.059	46.038	1.813	1.5	3.5
55	2.165	90	3.543	52	2.047	26	1.024	43	1.693	0.3	3.5
57.15	2.25	107.95	4.25	65.09	2.563	29.317	1.154	53.975	2.125	0.8	2.3
63.5	2.5	110	4.331	60.33	2.375	21.996	0.866	18.824	0.741	0.5	1.5
		114.673	4.515	68.255	2.687	21.996	0.866	61.903	2.437	0.5	1.5
		114.673	4.515	68.255	2.687	21.996	0.866	61.903	2.437	0.5	1.5
69.85	2.75	116.586	4.59	76.327	3.005	25.4	1	63.627	2.505	0.3	1.5
		146.05	5.75	91.516	3.603	39.688	1.563	59.766	2.353	1	3.5
		146.05	5.75	91.516	3.603	39.688	1.563	59.766	2.353	1	3.5
76.2	3	155.575	6.125	101.6	4	46.672	1.837	85.725	3.375	1.5	3.5
		161.925	6.375	105.562	4.156	46.038	1.813	70.637	2.781	0.8	3.5
92.075	3.625	152.4	6	82.55	3.25	36.322	1.43	63.5	2.5	0.8	3.5
95.25	3.75	149.225	5.875	66.672	2.625	28.971	1.141	52.388	2.063	0.8	3.5
96.838	3.813	188.912	7.437	107.95	4.25	46.038	1.813	69.85	2.75	1	3.5
		188.912	7.437	107.95	4.25	46.038	1.813	69.85	2.75	1	3.5
98.425	3.875	161.925	6.375	82.547	3.25	36.116	1.422	61.912	2.437	0.8	3.5
101.6	4	168.275	6.625	92.075	3.625	1.625	0.064	69.85	2.75	0.8	3.5
		200.025	7.875	115.888	4.563	49.212	1.937	80.216	3.158	2.3	3.5

Basic load ratings		Limit speed ratings		Designations	Calculation coefficient				Weight
C _r	C _{0r}	Grease	Oil		e	Y	Y ₀	a	
kN		r/min						kg	
80.5	126	4300	5500	KLM48548/KLM48510/DB	0.38	1.79	2.67	1.75	0.562
131	194	4800	6400	K27880/K27820D	0.56	1.2	1.79	1.18	1.33
98.5	134	4800	6400	K28158/K28318D	0.4	1.68	2.5	1.64	0.931
110	180	3200	4100	KLM104949E/KLM104911/DB	0.31	2.21	3.29	2.16	0.956
168	238	3600	4800	K55206/K55444D	0.88	0.76	1.14	0.75	2.87
140	240	3000	3800	KJLM506848E/KJLM506810/DB	0.41	1.66	2.47	1.62	1.24
211	292	3500	4700	K462/K452D	0.32	2.09	3.11	2.04	2.3
156	242	3200	4300	K390A/K394A+K390A/K394AB/DB	0.4	1.68	2.5	1.64	2.22
156	242	3200	4300	K390A/K394A+K390A/K394AB/HA1DB	0.4	1.68	2.5	1.64	2.22
156	242	3200	4300	K390A/K394ABD/HA1	0.4	1.68	2.5	1.64	2.44
165	310	3200	4300	K29675/K29620+K29675/K29620B/DB	0.49	1.38	2.06	1.35	2.63
335	515	3000	3500	KH913849/KH913810D	0.78	0.86	1.28	0.84	4.93
370	515	3000	3500	KH913849/KH913810/DB	0.78	0.86	1.28	0.84	4.86
450	730	1900	2500	K748S/K742D	0.33	2.08	3.09	2.03	8
425	580	1900	2500	K9285/K9220D	0.71	0.95	1.42	0.93	9.22
380	585	1900	2500	598/592D/C9	0.44	1.52	2.27	2.98	5.59
260	490	1900	2500	42376/42587D/C9	0.49	1.37	2.04	1.34	4.05
245	345	1600	2200	K90381/K90744D	0.87	0.78	1.16	0.76	12.2
270	345	1600	2200	K90381/K90744/DB	0.87	0.78	1.16	0.76	12.2
340	650	1800	2400	K52387/K52637D	0.47	1.42	2.12	1.39	6.35
370	700	1800	2400	K687/K672D	0.47	1.43	2.14	1.4	7.43
600	940	1600	2200	K98400/K98789D	0.63	1.07	1.59	1.04	13

Note: * indicates the maximum value of IDor OD.

Double-row Tapered Roller Bearing(Inch DB)

d 110~149.225 mm

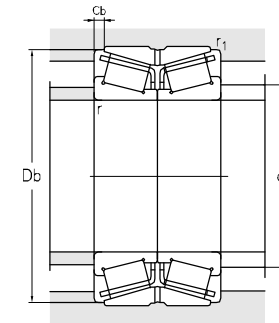
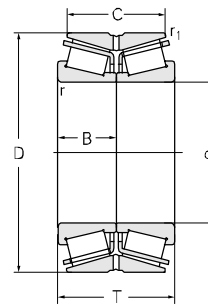
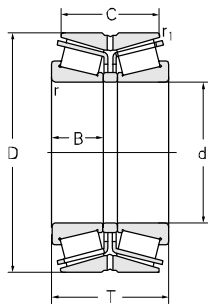

Principal dimensions											
d		D		T		B		C		r1	rmin
mm	in	mm	in	mm	in	mm	in	mm	in	mm	
110	4.331	180	7.087	103	4.055	103	4.055	85	3.346	0.6	3
111.125	4.375	214.312	8.437	115.888	4.563	52.388	2.063	84.138	3.313	1.5	3.5
114.3	4.5	177.8	7	92.075	3.625	41.275	1.625	69.85	2.75	0.8	3.5
		177.8	7	92.075	3.625	41.275	1.625	69.85	2.75	0.8	3.5
		190.5	7.5	106.365	4.188	49.212	1.937	80.962	3.187	1.5	3.5
		190.5	7.5	106.365	4.188	49.212	1.937	80.962	3.187	1.5	3.5
		212.725	8.375	142.875	5.625	66.675	2.625	117.475	4.625	1.5	7
		212.725	8.375	142.875	5.625	66.675	2.625	117.475	4.625	1.5	7
279.4	11	185.24	7.293	82.55	3.25	128.09	5.043	1.5	6.4		
120.65	4.75	174.625	6.875	77.787	3.062	36.512	1.437	61.912	2.437	0.8	3.5
		234.95	9.25	142.875	5.625	63.5	2.5	114.3	4.5	1.5	6.4
124.943	4.919	234.95	9.25	142.875	5.625	63.5	2.5	114.3	4.5	1.5	6.4
127	5	182.562	7.187	93.66	3.687	46.896	1.846	73.025	2.875	0.8	3.5
		182.562	7.187	93.66	3.687	46.896	1.846	73.025	2.875	0.8	3.5
		182.562	7.187	93.66	3.687	46.896	1.846	73.025	2.875	0.8	3.5
127.792	5.031	288.6	11.362	115.888	4.563	49.428	1.946	84.138	3.313	2.3	3.5
133.35	5.25	215.9	8.5	106.362	4.187	47.625	1.875	80.962	3.187	1.5	3.5
136.525	5.375	228.6	9	123.825	4.875	57.15	2.25	98.425	3.875	1.5	3.5
139.7	5.5	215.9	8.5	106.362	4.187	47.181	1.858	80.962	3.187	1.5	3.5
		215.9	8.5	106.362	4.187	47.181	1.858	80.962	3.187	1.5	3.5
		236.538	9.313	131.763	5.188	56.642	2.23	106.363	4.188	1.6	3.6
		244.475	9.625	107.95	4.25	53.975	2.125	79.375	3.125	1.5	3.5
142.875	5.625	200.025	7.875	87.315	3.438	39.688	1.563	73.025	2.875	0.8	3.5
		236.538	9.313	131.763	5.188	56.642	2.23	106.363	4.188	1.6	3.6
149.225	5.875	236.538	9.313	131.762	5.187	56.642	2.23	106.362	4.187	1.5	3.5

Basic load ratings		Limit speed ratings		Designations	Calculation coefficient				Weight
Cr	Cor	Grease	Oil		e	Y	Yo	a	
kN		r/min							kg
545	1020	1600	2200	KJHM522649/KJHM522610T103/DB	0.4	1.69	2.51	1.65	9.81
670	1100	1500	2000	KH924045/KH924010D	0.67	1	1.49	0.98	17.7
445	675	1600	2100	64450/64700D/C9	0.52	1.29	1.92	1.26	8.01
405	675	1600	2100	K64450/K64700D	0.52	1.29	1.92	1.26	8.01
525	965	1600	2100	K71450/K71751D	0.42	1.62	2.42	1.59	11.3
525	965	1600	2100	K71450/K71751DC	0.42	1.62	2.42	1.59	11.3
810	1390	1500	2000	938/932CD	0.33	2	3	4	20.8
810	1390	1500	2000	K938/K932CD	0.33	2	3	2	20.8
1350	2000	1000	1300	KHH926744/KHH926716/DB	0.63	1.07	1.6	1.05	51.9
360	730	1500	1800	KM224749/KM224710D	0.33	2	3	2	11.3
885	1620	1300	1600	K95475/K95927CD/YA10	0.37	1.83	2.72	1.79	26.5
885	1620	1300	1600	K95491/K95927D	0.37	1.83	2.72	1.79	26.9
460	860	1200	1500	NA48290SW/48220D/C9	0.31	2.21	3.29	2.16	7.26
465	895	1200	1500	NA48290SWSH/48220D/C9	0.31	2.21	3.29	2.16	7.34
465	895	1200	1500	NA48290SWSH/48220D/C9YB3	0.31	2.21	3.29	2.16	7.34
790	1350	1200	1500	KHM926749/KHM926710D	0.74	0.92	1.36	0.9	18.8
550	1090	1200	1500	74525/74851CD	0.32	2.12	3.15	2.07	13.7
705	1350	1200	1500	K896/K892D	0.42	1.61	2.39	1.57	19.9
550	1020	1200	1600	K74550/K74851CD	0.32	2.12	3.15	2.07	9.94
550	1020	1200	1600	K74550/K74851D	0.32	2.12	3.15	2.07	9.91
700	1400	1200	1500	K82550/K82932D	0.44	1.52	2.27	1.49	23.4
610	1100	1200	1500	NA81550/81963D/C9	0.35	2.07	3.08	2.02	19.3
430	1030	1200	1600	K48685/K48620D	0.34	2.01	2.99	1.96	8.15
700	1400	1100	1400	K82562/K82932D	0.44	1.52	2.27	1.49	23.3
815	1540	1100	1400	HM231149/HM231111CD	0.32	2.12	3.15	2.07	20.1

Note: * indicates the maximum value of IDor OD.

Double-row Tapered Roller Bearing(Inch DB)

d 152.4~180 mm

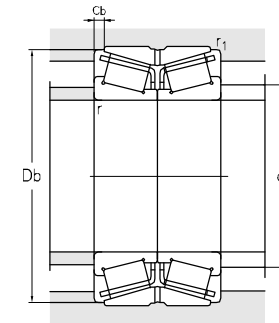
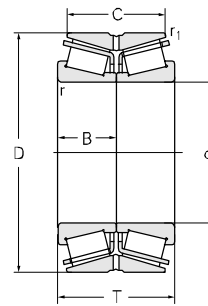
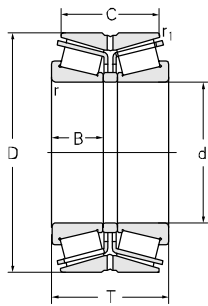

Principal dimensions											
d		D		T		B		C		r1min1	rmin
mm	in	mm	in	mm	in	mm	in	mm	in	mm	
152.4	6	254	10	142.875	5.625	66.675	2.625	111.125	4.375	1.5	7
		268.288	10.563	160.338	6.313	74.612	2.937	125.412	4.937	1.5	6.4
158.75	6.25	225.425	8.875	85.725	3.375	39.688	1.563	69.85	2.75	0.8	3.5
160.325	6.312	288.925	11.375	142.875	5.625	63.5	2.5	111.125	4.375	1.5	7
165.1	6.5	225.425	8.875	104.78	4.125	39.688	1.563	88.906	3.5	0.8	3.5
		247.65	9.75	103.188	4.063	47.625	1.875	84.138	3.313	0.8	3.5
		254	10	101.6	4	46.038	1.813	76.2	3	1.5	4.8
		288.925	11.375	142.875	5.625	63.5	2.5	111.125	4.375	1.5	7
		288.925	11.375	142.875	5.625	71.438	2.813	111.125	4.375	1.5	3.5
168.275	6.625	330.2	13	184.15	7.25	79.375	3.125	120.65	4.75	6.4	1.5
171.45	6.75	288.925	11.375	142.875	5.625	63.5	2.5	111.125	4.375	1.5	7
174.625	6.875	247.65	9.75	103.188	4.063	47.625	1.875	84.138	3.313	0.8	3.5
		247.65	9.75	103.188	4.063	47.625	1.875	84.138	3.313	0.8	3.5
177.8	7	269.875	10.625	119.062	4.687	55.562	2.187	93.662	3.687	1.5	3.5
		269.875	10.625	119.062	4.687	55.562	2.187	93.662	3.687	1.5	3.5
		269.875	10.625	119.062	4.687	55.562	2.187	93.662	3.687	1.5	3.5
		282.575	11.125	107.95	4.25	54.166	2.133	79.375	3.125	1.5	3.5
		288.925	11.375	142.875	5.625	63.5	2.5	111.125	4.375	1.5	7
		288.925	11.375	142.875	5.625	63.5	2.5	111.125	4.375	1.5	7
		288.925	11.375	142.875	5.625	63.5	2.5	111.125	4.375	1.5	7
		288.925	11.375	142.875	5.625	63.5	2.5	111.125	4.375	1.5	7
		288.925	11.375	142.875	5.625	63.5	2.5	111.125	4.375	1.5	7
		320.675	12.625	185.738	7.313	85.725	3.375	138.112	5.437	1.5	3.5
		320.675	12.625	185.738	7.313	85.725	3.375	138.112	5.437	1.5	3.5
180	7.087	250	9.843	103	4.055	45	1.772	83	3.268	1	3

Basic load ratings		Limit speed ratings		Designations	Calculation coefficient				Weight
Cr	Cor	Grease	Oil		e	Y	Yo	a	
kN		r/min							kg
1110	1850	940	1300	K99600/K99102CD	0.41	1.66	2.47	1.62	26.9
1380	2280	940	1300	KEE107060/K107105D-3/C9	0.39	1.74	2.59	1.7	36
460	1200	1000	1300	K46780/K46720CD	0.38	1.76	2.62	1.72	10.9
1080	1940	860	1100	KHM237532/KHM237510CD	0.32	2.12	3.15	2.07	37.2
455	1170	1000	1300	K46790/K46720/DB	0.38	1.76	2.62	1.72	10.8
710	1500	1000	1200	K67780/K67720D-3/C9	0.44	1.54	2.29	1.5	17.5
680	1300	950	1200	M235145/M235113D	0.32	2.12	3.15	2.07	16.9
1080	1940	1000	1200	KHM237535/KHM237510CD	0.32	2.11	3.14	2.06	36.5
1080	1940	1000	1200	KHM237536NA/KHM237510CD	0.32	2.11	3.14	2.06	36.5
1500	2370	840	1100	KH936349/KH936310D	0.81	0.8	1.2	0.8	63.4
985	2020	840	1100	K94675/K94114D	0.47	1.44	2.15	1.41	36.1
710	1500	940	1300	K67787/K67720CD	0.44	1.52	2.27	1.49	15.5
710	1500	940	1300	K67787/K67720D	0.44	1.52	2.27	1.49	15.5
725	1720	940	1300	KM238840/KM238810CD/YA10	0.33	2.03	3.02	1.98	21.4
795	1720	940	1300	KM238840/KM238810D	0.33	2.03	3.02	1.98	22
725	1720	940	1300	M238840/M238810CD/YA10	0.33	2.04	3.03	1.99	21.4
700	1450	940	1300	KNA87700SW/K87112D	0.41	1.66	2.47	1.62	24
1080	1940	940	1300	HM237545/HM237510CD	0.33	2.07	3.09	2.03	32.7
1080	1940	940	1300	HM237545X2/HM237510CDX2	0.33	2.07	3.09	2.03	32.7
1080	1940	940	1300	HM237545X2/HM237510CDX2/C9	0.33	2.07	3.09	2.03	32.7
1010	2020	940	1300	K94700/K94114CD	0.47	1.44	2.15	1.41	34
1080	1940	940	1300	KHM237545/KHM237510CD/YA1	0.32	2.11	3.14	2.06	32.9
1170	2170	940	1300	KHM237545/KHM237510D	0.33	2.07	3.09	2.03	36.2
1400	2760	840	1100	KEE222070/K222127CD	0.4	1.68	2.50	1.64	61.5
1400	2760	840	1100	KEE222070/K222127D	0.4	1.68	2.5	1.64	61.5
1590	2830	840	1100	KH239640/KH239612D	0.32	2.12	3.15	2.07	58.9
655	1490	900	1100	KJM736149/KJM736110/DB	0.48	1.41	2.09	1.37	14.3

Note: * indicates the maximum value of IDor OD.

Double-row Tapered Roller Bearing(Inch DB)

d 187.325~228.46 mm

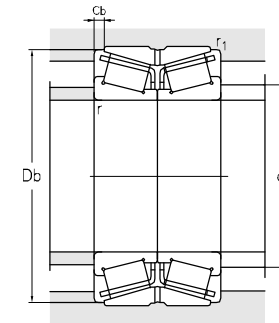
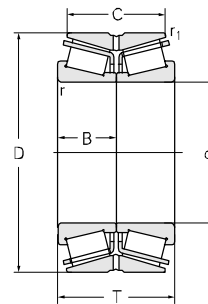
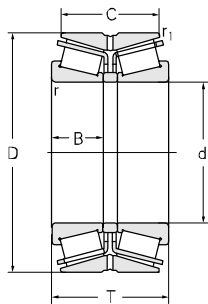

Principal dimensions											
d		D		T		B		C		r1min1	rmin
mm	in	mm	in	mm	in	mm	in	mm	in	mm	
187.325	7.375	269.875	10.625	119.062	4.687	55.562	2.187	93.662	3.687	1.5	3.5
		269.875	10.625	119.062	4.687	55.562	2.187	93.662	3.687	1.5	3.5
		269.875	10.625	119.062	4.687	55.562	2.187	93.662	3.687	1.5	3.5
		320.675	12.625	185.738	7.313	85.725	3.375	138.112	5.437	1.5	5.5
190	7.48	260	10.236	102	4.016	44	1.732	83	3.268	1	8
		368.3	14.5	193.675	7.625	88.897	3.5	136.525	5.375	1.5	6.4
190.5	7.5	266.7	10.5	109.538	4.313	54.961	2.164	84.138	3.313	0.8	3.5
		368.3	14.5	193.675	7.625	88.897	3.5	136.525	5.375	1.5	6.4
		317.5	12.5	146.05	5.75	63.5	2.5	111.125	4.375	1.5	4.3
		317.5	12.5	146.05	5.75	63.5	2.5	111.125	4.375	1.5	4.3
		317.5	12.5	146.05	5.75	63.5	2.5	111.125	4.375	1.5	4.3
200.025	7.875	317.5	12.5	146.05	5.75	63.5	2.5	111.125	4.375	1.5	4.3
		317.5	12.5	146.05	5.75	63.5	2.5	111.125	4.375	1.5	4.3
		317.5	12.5	146.05	5.75	63.5	2.5	111.125	4.375	1.5	4.3
		384.175	15.125	238.125	9.375	112.712	4.437	193.675	7.625	1.5	6.4
		384.175	15.125	238.125	9.375	112.712	4.437	193.675	7.625	1.5	6.4
203.2	8	276.225	10.875	95.25	3.75	47.625	1.875	73.025	2.875	0.8	3.5
		276.225	10.875	95.25	3.75	47.816	1.883	73.025	2.875	0.8	3.5
		276.225	10.875	95.25	3.75	47.816	1.883	73.025	2.875	0.8	3.5
		276.225	10.875	95.25	3.75	47.816	1.883	73.025	2.875	0.8	3.5
		292.1	11.5	125.415	4.938	57.945	2.281	101.6	4	1.5	3.5
		317.5	12.5	146.05	5.75	63.5	2.5	111.125	4.375	1.5	4.3
		317.5	12.5	146.05	5.75	63.5	2.5	111.125	4.375	1.5	4.3
		317.5	12.5	146.05	5.75	63.5	2.5	111.125	4.375	1.5	4.3
		368.3	14.5	193.675	7.625	88.897	3.5	136.525	5.375	1.5	3.3
		368.3	14.5	193.675	7.625	88.897	3.5	136.525	5.375	1.5	3.3
		368.3	14.5	193.675	7.625	88.897	3.5	136.525	5.375	1.5	3.3
		206.375	8.125	336.55	13.25	211.138	8.313	100.012	3.937	169.862	6.687
212.725	8.375	285.75	11.25	98.425	3.875	46.038	1.813	76.2	3	0.8	3.5
220.662	8.687	314.325	12.375	131.762	5.187	61.912	2.437	106.362	4.187	1.5	6.4
		314.325	12.375	131.762	5.187	61.912	2.437	106.362	4.187	1.5	6.4
		314.325	12.375	131.762	5.187	61.912	2.437	106.362	4.187	1.5	6.4
		314.325	12.375	131.762	5.187	61.912	2.437	106.362	4.187	1.5	6.4
228.46	8.994	431.8	17	196.85	7.75	85.725	3.375	111.125	4.375	3.3	6.4

Basic load ratings		Limit speed ratings		Designations	Calculation coefficient				Weight
Cr	Cor	Grease	Oil		e	Y	Yo	a	
kN		r/min							kg
795	1720	940	1300	KM238849/KM238810CD	0.33	2.04	3.03	1.99	19.3
985	1810	940	1300	M238849/M238810CD-2/C9	0.33	2.04	3.03	1.99	19.3
985	1810	940	1300	M238849/M238810DC	0.33	2.04	3.03	1.99	19.3
1590	2830	850	1100	KH239649/KH239612CD	0.32	2.12	3.15	2.07	55.4
630	1460	860	1100	KJM738249A/KJM738210/DB	0.48	1.41	2.11	1.38	14.1
615	1520	940	1300	KNA67885SW/K67820D	0.48	1.41	2.11	1.38	15.3
1680	2900	700	950	KEE420751/K421451CD	0.4	1.68	2.50	1.64	84
1035	2270	840	1100	93787/93127D	0.52	1.29	1.92	1.26	40.8
1035	2270	840	1100	K93787/K93127CD	0.52	1.29	1.92	1.26	40.6
1035	2270	840	1100	K93787/K93127D	0.52	1.29	1.92	1.26	40.8
2320	5080	690	920	KH247535/KH247510CD	0.33	2.03	3.02	1.98	112
2320	5080	690	920	KH247535/KH247510CD-3	0.33	2.03	3.02	1.98	112
635	1440	780	990	LM241149NW/LM241110D/C9	0.32	2.12	3.15	2.07	15.4
580	1350	780	990	LM241149NW/LM241110D/C9YAB	0.32	2.12	3.15	2.07	15
610	1440	940	1300	KLM241149NW/KLM241110D	0.32	2.12	3.15	2.07	15.3
640	1350	840	1100	KLM241149NWSH/KLM241110DSH	0.32	2.1	3.12	2.05	15
990	2120	760	960	M241547/M241510CD	0.33	2.03	3.02	1.98	26.6
1035	2270	840	1100	K93800/K93127D	0.52	1.29	1.92	1.26	39.8
1030	2270	840	1100	KNA93800SW/K93127D	0.52	1.28	1.92	1.26	39.6
1680	2900	840	1100	EE420801/421451CD	0.4	1.69	2.52	1.65	78.8
1530	2900	840	1100	KEE420801/K421451CD	0.4	1.69	2.52	1.65	78.8
1980	4170	670	900	H242649/H242610CD-3	0.34	2	2.98	1.96	67.9
630	1630	670	900	KLM742745/KLM742710CD	0.48	1.41	2.09	1.38	16.9
1050	2450	760	1000	KM244249/KM244210CD-2-JG	0.33	2.03	3.02	1.98	30.5
1050	2450	760	1000	KM244249/KM244210D	0.33	2.03	3.02	1.98	30.5
1050	2450	760	1000	KM244249/KM244210D-3	0.33	2.03	3.02	1.98	31.2
1050	2300	760	1000	M244249/M244210CD	0.33	2.03	3.02	1.98	30.5
1850	3200	600	800	KEE113091/K113171D-2-JG	0.88	0.77	1.14	0.75	111

Note: * indicates the maximum value of ID or OD.

Double-row Tapered Roller Bearing(Inch DB)

d 228.6~260.35 mm

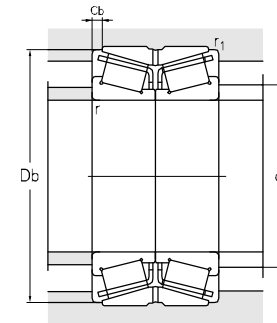
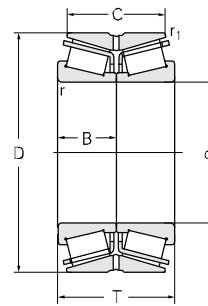
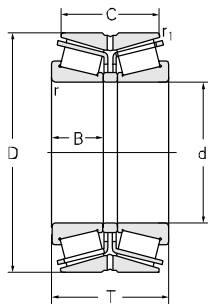

Principal dimensions											
d		D		T		B		C		r1min1	rmin
mm	in	mm	in	mm	in	mm	in	mm	in	mm	
228.6	9	327.025	12.875	114.3	4.5	52.388	2.063	82.55	3.25	1.5	6.4
		355.6	14	152.4	6	69.85	2.75	111.125	4.375	1.5	6.8
		355.6	14	152.4	6	69.85	2.75	114.3	4.5	1.5	6.4
		488.95	19.25	254	10	120.65	4.75	196.85	7.75	1.5	6.4
234.95	9.25	327.025	12.875	114.3	4.5	52.388	2.063	82.55	3.25	1.5	6.4
		327.025	12.875	114.3	4.5	52.388	2.063	82.55	3.25	1.5	6.4
		348.175	13.708	238.125	9.375	112.712	4.437	193.675	7.625	1.5	6.4
237.33	9.344	358.775	14.125	152.4	6	71.438	2.813	117.475	4.625	1.5	6.4
241.3	9.5	327.025	12.875	114.3	4.5	52.388	2.063	82.55	3.25	1.5	6.4
		327.025	12.875	114.3	4.5	52.388	2.063	82.55	3.25	1.5	6.4
		406.4	16	215.9	8.5	100.012	3.937	184.15	7.25	1.5	6.4
		444.5	17.5	209.55	8.25	100.012	3.937	158.75	6.25	1.5	6.4
		444.5	17.5	209.55	8.25	100.012	3.937	158.75	6.25	1.5	6.4
249.25	9.813	381	15	171.45	6.75	76.2	3	127	5	1.5	6.4
		381	15	171.45	6.75	76.2	3	127	5	1.5	6.4
253.975	9.999	347.662	13.687	101.6	4	50.99	2.007	69.85	2.75	1.5	3.5
254	10	347.662	13.687	101.6	4	50.99	2.007	69.85	2.75	1.5	3.5
		347.662	13.687	101.6	4	50.99	2.007	69.85	2.75	1.5	3.5
		358.775	14.125	152.4	6	71.438	2.813	117.475	4.625	1.5	3.5
		358.775	14.125	152.4	6	71.438	2.813	117.475	4.625	1.5	3.5
		358.775	14.125	152.4	6	71.438	2.813	117.475	4.625	1.5	3.5
		358.775	14.125	152.4	6	71.438	2.813	117.475	4.625	1.5	3.5
		393.7	15.5	157.162	6.187	69.85	2.75	109.538	4.313	1.5	6.4
260.35	10.25	365.125	14.375	130.175	5.125	58.738	2.313	98.425	3.875	1.5	6.4
		365.125	14.375	130.175	5.125	58.738	2.313	98.425	3.875	1.5	6.4
		365.125	14.375	130.175	5.125	58.738	2.313	98.425	3.875	1.5	6.4
		400.05	15.75	155.58	6.125	67.47	2.656	107.95	4.25	1.5	9.7
		419.1	16.5	184.15	7.25	84.138	3.313	136.525	5.375	1.5	6.4
		419.1	16.5	184.15	7.25	84.138	3.313	136.525	5.375	1.5	6.4

Basic load ratings		Limit speed ratings		Designations	Calculation coefficient				Weight
Cr	Cor	Grease	Oil		e	Y	Yo	a	
kN		r/min							kg
790	1830	760	1000	K8573/K8520CD	0.41	1.66	2.47	1.62	28.9
1200	2500	760	1000	KEE130902/K131401CD	0.33	2.03	3.02	1.98	50.2
1300	2700	760	1000	KHM746646/KHM746610CD	0.47	1.44	2.15	1.41	52.4
2910	5650	630	840	KEE295950/K295192D/C9	0.31	2.18	3.24	2.13	217
790	1830	760	1000	K8575/K8520CD	0.41	1.66	2.47	1.62	26.9
790	1830	760	1000	K8575/K8520D-C3	0.41	1.66	2.47	1.62	26.9
2320	5080	750	950	KH247549/KH247510D	0.33	2.03	3.02	1.98	111
1530	3090	750	950	KRM249736/M249710CD	0.33	2.03	3.02	1.98	53.2
790	1830	760	1000	K8578/K8520CD	0.41	1.66	2.47	1.62	25
790	1830	760	1000	K8578/K8520DC	0.41	1.66	2.47	1.62	25
2390	4950	760	1000	KH249148/KH249111CD	0.33	2.03	3.02	1.98	110
2480	4650	760	1000	EE923095/923176D	0.34	2.01	2.99	1.96	135
2480	4650	760	1000	KEE923095/K923176D	0.34	2	2.98	1.96	135
1240	2960	690	920	KEE126098/K126151CD	0.52	1.31	1.94	1.28	63.4
1240	2960	690	920	KEE126098/K126151CD-3	0.52	1.31	1.94	1.28	63.4
750	1740	690	920	LM249747NW/LM249710CD/C9YAB	0.33	2.03	3.02	1.98	25.3
825	1740	690	920	KLM249747NW/KLM249710D	0.33	2.03	3.02	1.98	25.3
825	1740	690	920	KLM249747NWSH/KLM249710D	0.33	2.03	3.02	1.98	24.2
1530	3090	690	920	KRM249749/M249710CD	0.33	2.03	3.02	1.98	46.9
1530	3090	690	920	KRM249749/M249710CD-SMJ	0.33	2.03	3.02	1.98	45.8
1530	3090	690	920	M249749/M249710CD	0.33	2.03	3.02	1.98	46.9
1530	3090	690	920	M249749/M249710CD-SMJ	0.33	2.03	3.02	1.98	46.9
1290	2830	690	920	KEE275100/K275156D	0.4	1.68	2.5	1.64	66.4
885	2200	670	900	EE134102/134144CD	0.37	1.8	2.69	1.76	37.3
975	2200	670	900	EE134102/134144D	0.37	1.8	2.69	1.76	37.3
885	2200	670	900	EE134102/134144D/HE	0.37	1.8	2.69	1.76	37.3
1260	2500	670	900	KEE221026/K221576CD	0.39	1.71	2.54	1.67	61.7
1770	3890	670	900	EE435102/435165CD	0.6	1.13	1.68	1.1	92.1
1770	3890	670	900	EE435102/435165CD/YA1	0.6	1.13	1.68	1.1	92.1

Note: * indicates the maximum value of IDor OD.

Double-row Tapered Roller Bearing(Inch DB)

d 260.35~304.8 mm

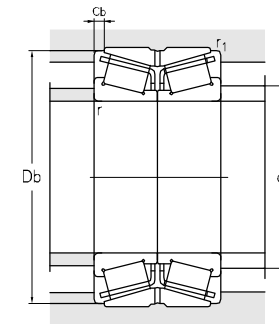
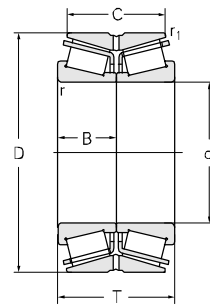
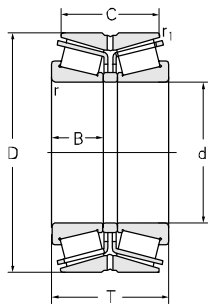

Principal dimensions												
d		D		T		B		C		r _{1min1}	r _{min}	
mm	in	mm	in	mm	in	mm	in	mm	in	mm	mm	
260.35		422.275	16.625	178.592	7.031	79.771	3.141	139.7	5.5	1.5	6.8	
		422.275	16.625	178.592	7.031	79.771	3.141	139.7	5.5	1.5	6.8	
263.525		10.375	355.6	14	127	5	57.15	2.25	101.6	4	1.5	3.5
266.7		10.5	355.6	14	127	5	57.15	2.25	101.6	4	1.5	3.5
269.875		10.625	381	15	158.75	6.25	74.612	2.937	123.825	4.875	1.5	6.4
273.05		10.75	393.7	15.5	157.162	6.187	69.85	2.75	109.538	4.313	1.5	6.4
279.4		11	469.9	18.5	200.025	7.875	93.662	3.687	149.225	5.875	1.5	9.7
			488.95	19.25	254	10	120.65	4.75	196.85	7.75	1.3	1.5
279.982		11.023	380.898	14.996	139.7	5.5	65.088	2.563	107.95	4.25	1.5	3.5
			380.898	14.996	139.7	5.5	65.088	2.563	107.95	4.25	1.5	3.5
280.192		11.031	406.4	16	149.226	5.875	67.673	2.664	117.475	4.625	1.5	6.8
285.75		11.25	380.898	14.996	139.7	5.5	65.088	2.563	107.95	4.25	1.5	3.5
288.925		11.375	406.6	16.008	165.1	6.5	77.788	3.063	130.175	5.125	1	6.4
			406.6	16.008	165.1	6.5	77.788	3.063	130.175	5.125	1	6.4
			406.4	16	165.1	6.5	77.788	3.063	130.175	5.125	1	6.4
			406.6	16.008	165.1	6.5	77.788	3.063	130.175	5.125	1	6.4
			406.6	16.008	165.1	6.5	77.788	3.063	130.175	5.125	1	6.4
			406.6	16.008	165.1	6.5	77.788	3.063	130.175	5.125	1	6.4
			406.6	16.008	165.1	6.5	77.788	3.063	130.175	5.125	1	6.4
300.038		11.813	422.275	16.625	174.625	6.875	82.55	3.25	136.525	5.375	1.5	6.4
			422.275	16.625	174.625	6.875	82.55	3.25	136.525	5.375	1.5	6.4
			422.275	16.625	174.625	6.875	82.55	3.25	136.525	5.375	1.5	6.4
			422.275	16.625	174.625	6.875	82.55	3.25	136.525	5.375	1.5	6.4
304.8		12	393.7	15.5	107.95	4.25	54.166	2.133	82.55	3.25	1.5	6.4
			393.7	15.5	107.95	4.25	50.8	2	82.55	3.25	1.5	6.4

Basic load ratings		Limit speed ratings		Designations	Calculation coefficient				Weight
C _r	C _{0r}	Grease	Oil		e	Y	Y ₀	a	
kN		r/min							kg
1980	3750	670	900	HM252348/HM252310CD	0.33	2.03	3.02	1.98	89.1
1760	3750	670	900	KHM252348/KHM252310CD	0.33	2.03	3.02	1.98	89.1
985	2700	670	900	KLM451345/KLM451310CD	0.36	1.87	2.79	1.83	34
1080	2700	670	900	KLM451349/KLM451310CD	0.36	1.88	2.79	1.83	32.8
1740	3350	600	800	M252349/M252310CD	0.33	2.03	3.02	1.98	51.8
1290	2830	600	800	KEE275108/K275156CD	0.4	1.68	2.5	1.64	56.3
2740	5000	590	780	EE722110/722186D	0.38	1.79	2.67	1.75	132
2910	5650	580	770	EE295110/295192D	0.31	2.18	3.45	2.13	188
1035	2830	600	800	KLM654642/KLM654610CD	0.43	1.57	2.34	1.53	41.6
1130	2830	600	800	KLM654642/KLM654610CD/YA1	0.43	1.57	2.34	1.53	41.6
1320	2950	600	800	KEE128111/K128160CD	0.39	1.71	2.54	1.67	56.7
1130	2830	600	800	LM654649/LM654610CD	0.43	1.57	2.34	1.53	39.2
1720	4150	580	770	KM255449/KM255410CD	0.34	2	2.98	1.96	64.1
1620	4100	580	770	M255449/M255410CD	0.34	2	2.98	1.96	64.1
1620	4100	580	770	M255449/M255410CD-1	0.34	2	2.97	1.95	64.1
1620	4100	580	770	M255449/M255410CD	0.34	2	2.98	1.96	64.1
1620	4100	580	770	M255449/M255410CD/HE	0.34	2	2.98	1.96	64.1
1620	4100	580	770	M255449/M255410CD/HE-SMJ	0.34	2	2.98	1.96	64.1
1620	4100	580	770	M255449/M255410CD-SMJ	0.34	2	2.98	1.96	64.1
1560	4050	580	770	HM256849/HM256810CD	0.33	2	3	2	69.7
1560	4050	580	770	HM256849/HM256810CD/C9	0.33	2	3	2	69.7
1560	4050	580	770	HM256849/HM256810CD/YA1	0.33	2	3	2	69.7
1720	4050	580	770	HM256849/HM256810D	0.34	2	2.98	1.96	69.7
970	2330	580	770	KL357049NW/KL357010D	0.36	1.89	2.81	1.84	30.1
1070	2330	580	770	L357049/L357010CD	0.36	1.89	2.81	1.84	30.5

Note: * indicates the maximum value of IDor OD.

Double-row Tapered Roller Bearing(Inch DB)

d 304.8~368.249 mm

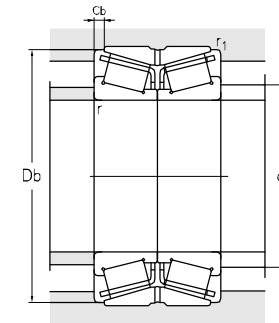
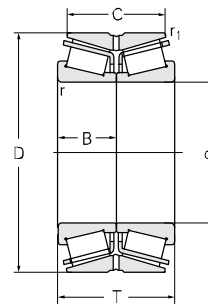
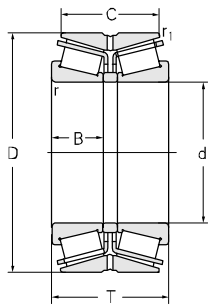

Principal dimensions											
d		D		T		B		C		r1min1	rmin
mm	in	mm	in	mm	in	mm	in	mm	in	mm	
304.8		393.7	15.5	107.95	4.25	50.8	2	82.55	3.25	1.5	6.4
		393.7	15.5	107.95	4.25	54.166	2.133	82.55	3.25	1.5	6.4
		412.75	16.25	123.825	4.875	53.975	2.125	92.075	3.625	1.5	6.4
		444.5	17.5	146.05	5.75	61.912	2.437	98.425	3.875	1.5	8
		495.3	19.5	196.85	7.75	92.075	3.625	146.05	5.75	1.5	16
311.15	12.25	558.8	22	190.5	7.5	82.55	3.25	111.125	4.375	3.3	9.7
317.5	12.5	444.5	17.5	146.05	5.75	61.912	2.437	98.425	3.875	1.5	8
		447.675	17.625	180.975	7.125	85.725	3.375	146.05	5.75	1.5	3.5
		447.675	17.625	180.975	7.125	85.725	3.375	146.05	5.75	1.5	3.5
		447.675	17.625	180.975	7.125	85.725	3.375	146.05	5.75	1.5	3.5
330.2	13	482.6	19	177.8	7	80.167	3.156	127	5	1.5	6.4
333.375	13.125	469.9	18.5	190.5	7.5	90.488	3.563	152.4	6	1.5	6.4
		469.9	18.5	190.5	7.5	90.488	3.563	152.4	6	1.5	6.4
342.9	13.5	457.098	17.996	142.875	5.625	63.5	2.5	104.775	4.125	1.6	3.6
		457.098	17.996	142.875	5.625	63.5	2.5	101.6	4	1.5	3.3
		533.4	21	165.1	6.5	76.2	3	114.3	4.5	1.5	4.8
343.154	13.51	450.85	17.75	189.35	7.455	66.675	2.625	52.388	2.063	1	8.5
346.075	13.625	488.95	19.25	200.025	7.875	95.25	3.75	158.75	6.25	1.5	6.4
		488.95	19.25	200.025	7.875	95.25	3.75	158.75	6.25	1.5	6.4
		488.95	19.25	200.025	7.875	95.25	3.75	158.75	6.25	1.5	6.4
355.6	14	444.5	17.5	136.524	5.375	60.325	2.375	111.125	4.375	1.5	3.5
		444.5	17.5	136.524	5.375	60.325	2.375	111.125	4.375	1.5	3.5
		444.5	17.5	136.524	5.375	60.325	2.375	111.125	4.375	1.5	3.5
		501.65	19.75	155.575	6.125	66.675	2.625	107.95	4.25	1.5	6.4
		501.65	19.75	145.05	5.711	61.413	2.418	107.95	4.25	1.5	6.4
		514.35	20.25	193.675	7.625	84.138	3.313	152.4	6	1.5	6.4
368.249	14.498	523.875	20.625	214.312	8.437	101.6	4	169.862	6.687	1.5	6.4

Basic load ratings		Limit speed ratings		Designations	Calculation coefficient				Weight
Cr	Cor	Grease	Oil		e	Y	Yo	a	
kN		r/min							kg
1070	2330	580	770	L357049/L357010D	0.33	2.04	3.04	2	30.5
970	2330	580	770	L357049NW/L357010CD/C9YAB	0.36	1.89	2.81	1.84	30.1
1060	2350	580	770	EE109120/109163D	0.43	1.6	2.3	1.6	42.4
1240	2770	550	700	EE291201/291751D	0.38	1.79	2.67	1.75	64.9
2300	5000	500	660	EE724120/724196CD-3	0.4	1.68	2.5	1.64	139
2130	4140	550	720	EE148122/148220D	0.88	0.77	1.14	0.75	184
1240	2770	490	650	KEE291250/K291751CD	0.38	1.79	2.67	1.75	59.0
1800	4650	490	650	HM259049/HM259010CD-SMJ	0.33	2	3	2	85.4
1800	4650	490	650	HM259049/HM259010CD	0.33	2	3	2	85.4
1800	4650	490	650	KHM259049/KHM259010CD	0.33	2	3	2	85.4
2130	4650	490	650	EE526130/526191CD-2/C9YAD	0.47	1.44	2.14	1.4	100
2070	5080	490	650	HM261049/HM261010CD/YA1	0.33	2.02	3	1.97	97.7
2070	5080	490	650	HM261049/HM261010D	0.33	2.02	3	1.97	97.7
1300	3500	480	630	KLM961548A6/KLM961511DX2A6	0.7	0.97	1.44	0.94	45
1300	3550	480	630	KLM961548/KLM961511D	0.7	0.97	1.44	0.94	44.8
2200	4500	480	630	KEE971354/K972102D-3	0.33	2.03	3.02	1.98	120
1320	3500	480	630	KLM361649A/KLM361610/C9DB	0.35	1.93	2.87	1.89	59.2
2400	5800	480	630	HM262749/HM262710CD/YA1	0.34	1.99	2.96	1.95	108
2400	5800	480	630	HM262749/HM262710D	0.33	2	3	2	108
2560	6450	480	630	HM262749SH/HM262710CDSH/C9	0.33	2	3	2	114
1110	3450	460	600	KL163149/KL163110CD	0.31	2.2	3.27	2.15	46.1
1110	3450	460	600	KL163149NW/KL163110CD	0.31	2.2	3.27	2.15	46.1
1110	3450	460	600	L163149/L163110CD	0.31	2.2	3.27	2.15	46.1
1410	3450	410	540	EE231400/231976CD/YAD	0.44	1.53	2.28	1.5	88.1
1410	3450	420	560	KEE231400/K231976CDX2	0.44	1.53	2.28	1.5	83.4
2150	4950	410	540	EE333140/333203CD	0.37	1.8	2.7	1.8	120
2520	6070	400	520	HM265049/HM265010D	0.33	2.03	3.02	1.98	136

Note: * indicates the maximum value of IDor OD.

Double-row Tapered Roller Bearing(Inch DB)

d 368.3~479.425 mm

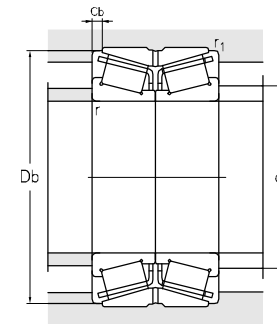
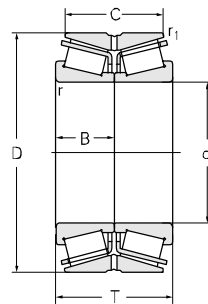
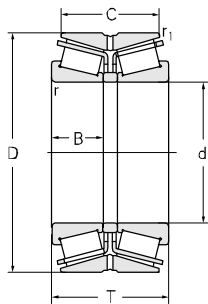

Principal dimensions

d	D	T	B	C	r _{1min1}	r _{min}
mm	in	mm	in	mm	in	mm
368.3	14.5	596.9	23.5	203.2	8	92.075 3.625 133.35 5.25 2.3 9.7
371.475	14.625	501.65	19.75	155.575	6.125	66.675 2.625 107.95 4.25 1.5 6.4
381	15	546.1	21.5	222.25	8.75	104.775 4.125 177.8 7 1.5 6.4
		590.55	23.25	244.475	9.625	114.3 4.5 193.675 7.625 1.5 6.4
		590.55	23.25	244.475	9.625	114.3 4.5 193.675 7.625 1.5 6.4
		590.55	23.25	244.475	9.625	114.3 4.5 193.675 7.625 1.5 6.4
384.175	15.125	546.1	21.5	222.25	8.75	104.775 4.125 177.8 7 1.5 6.4
		546.1	21.5	222.25	8.75	104.775 4.125 177.8 7 1.5 6.4
385.762	15.187	514.35	20.25	177.8	7	82.55 3.25 139.7 5.5 1.5 6.4
		514.35	20.25	177.8	7	82.55 3.25 139.7 5.5 1.5 6.4
406.4	16	609.6	24	187.325	7.375	84.138 3.313 123.825 4.875 1.5 6.8
409.575	16.125	635	25	257.175	10.125	120.65 4.75 206.375 8.125 1.5 6.4
415.925	16.375	590.55	23.25	250	9.843	114.3 4.5 199.2 7.843 1.6 6.4
		590.55	23.25	244.475	9.625	114.3 4.5 193.675 7.625 1.5 6.4
		590.55	23.25	244.475	9.625	114.3 4.5 193.675 7.625 1.5 6.4
		590.55	23.25	244.475	9.625	114.3 4.5 193.675 7.625 1.5 6.4
431.8	17	565.15	22.25	100.22	3.946	44.45 1.75 74.82 2.946 1.5 3.3
		571.5	22.5	155.575	6.125	74.612 2.937 111.125 4.375 1.5 3.3
		571.5	22.5	155.575	6.125	74.612 2.937 111.125 4.375 1.5 3.3
447.675	17.625	635	25	257.175	10.125	120.65 4.75 206.375 8.125 1.5 6.4
457.2	18	596.9	23.5	165.1	6.5	73.025 2.875 120.65 4.75 1.5 9.7
479.425	18.875	679.45	26.75	276.225	10.875	128.588 5.063 222.25 8.75 1.5 6.4
		679.45	26.75	276.225	10.875	128.588 5.063 222.25 8.75 1.5 6.4
		679.45	26.75	276.225	10.875	128.588 5.063 222.25 8.75 1.5 6.4
		679.45	26.75	276.225	10.875	128.588 5.063 222.25 8.75 1.5 6.4

Basic load ratings		Limit speed ratings		Designations	Calculation coefficient				Weight
C _r	C _{0r}	Grease	Oil		e	Y	Y ₀	a	
kN		r/min							kg
2640	5200	400	520	EE181453/182351D	0.42	1.62	2.42	1.59	191
1410	3450	400	520	KEE231462/K231976CD	0.44	1.53	2.28	1.5	76.9
2910	8200	380	500	KHM266447/KHM266410CD-3	0.33	2.03	3.02	1.98	163
2820	8050	380	500	M268730/M268710CD/HE	0.33	2.03	3.02	1.98	245
4500	6600	380	500	M268730/M268710D/C9	0.33	2.03	3.02	1.98	247
3550	8800	380	500	M268730/M268710DC	0.33	2.03	3.02	1.98	245
3200	8200	410	540	HM266448/HM266410CD	0.33	2.04	3.02	1.98	161
3700	7900	410	540	HM266449/HM266410D/YA10	0.33	2	3	2	158
2050	5600	450	680	LM665949/LM665910CD	0.42	1.62	2.42	1.59	100
2050	5600	450	680	LM665949/LM665910DC	0.42	1.62	2.42	1.59	100
2500	5500	380	500	EE911600/912401D	0.38	1.76	2.62	1.72	169
4650	10300	380	500	M270730/M270710CD	0.33	2	3	2	300
3600	8250	380	500	M268749/M268710DX2	0.33	2.03	3.02	1.98	206
3250	8550	380	500	M268749/M268710DC	0.33	2.03	3.02	1.98	205
3250	8550	380	500	M268749/M268710DC/HEC9	0.33	2.03	3.02	1.98	205
3250	8550	380	500	M268749/M268710DC/HE	0.33	2.03	3.02	1.98	205
1010	2810	410	540	K80170/K80222/DB	0.32	2.12	3.15	2.07	61.2
1510	4200	410	540	KLM869448/KLM869410CD	0.55	1.24	1.84	1.21	102
1660	4200	410	540	LM869448/LM869410CD	0.55	1.24	1.84	1.21	102
4650	10300	360	480	M270749/M270710CD	0.33	2	3	2	247
1860	5000	380	500	EE244180/244236CD	0.4	1.67	2.48	1.63	109
4500	11900	320	440	M272749/M272710D-3	0.33	2.03	3.02	1.98	307
4180	10900	320	440	M272749/M272710DC	0.33	2.03	3.02	1.98	307
4200	10900	320	440	M272749/M272710DC/HE	0.33	2.03	3.02	1.98	307
4200	10900	320	440	M272749/M272710DC/HEC9	0.33	2.03	3.02	1.98	307

Note: * indicates the maximum value of IDor OD.

Double-row Tapered Roller Bearing(Inch DB)

d 482.6~723.9 mm

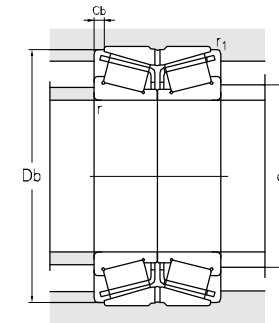
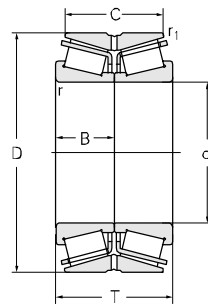
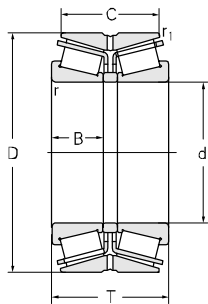

Principal dimensions											
d		D		T		B		C		r1min1	rmin
mm	in	mm	in	mm	in	mm	in	mm	in	mm	
482.6	19	615.95	24.25	184.15	7.25	85.725	3.375	146.05	5.75	1.5	6.4
488.671	19.239	660.4	26	206.375	8.125	94.458	3.719	158.75	6.25	1.5	6.4
488.95	19.25	660.4	26	206.375	8.125	94.458	3.719	158.75	6.25	1.5	6.4
		660.4	26	206.375	8.125	94.458	3.719	158.75	6.25	1.5	6.4
498.475	19.625	634.873	24.995	177.8	7	80.962	3.187	142.875	5.625	1.5	6.4
501.65	19.75	711.2	28	292.1	11.5	136.525	5.375	231.775	9.125	1.5	6.4
		711.2	28	292.1	11.5	136.525	5.375	231.775	9.125	1.5	6.4
533.4	21	812.8	32	269.875	10.625	123.825	4.875	187.325	7.375	3.3	9.7
		812.8	32	269.875	10.625	123.825	4.875	187.325	7.375	3.3	9.7
		812.8	32	269.875	10.625	123.825	4.875	187.325	7.375	3.3	9.7
536.575	21.125	761.873	29.995	311.15	12.25	146.05	5.75	247.65	9.75	1.5	6.4
		761.873	29.995	311.15	12.25	146.05	5.75	247.65	9.75	1.5	6.4
		761.873	29.995	311.15	12.25	146.05	5.75	247.65	9.75	1.5	6.4
546.1	21.5	736.6	29	165.1	6.5	82.741	3.258	114.3	4.5	3.3	6.4
558.5	21.988	736.6	29	225.425	8.875	104.775	4.125	177.8	7	1.5	6.4
		736.6	29	225.425	8.875	104.775	4.125	177.8	7	1.5	6.4
571.5	22.5	812.8	32	333.375	13.125	155.575	6.125	263.525	10.375	1.5	6.4
609.6	24	787.4	31	206.375	8.125	93.662	3.687	158.75	6.25	1.5	6.4
660.4	26	812.8	32	203.2	8	95.25	3.75	158.75	6.25	1.5	6.4
		812.8	32	203.2	8	95.25	3.75	158.75	6.25	1.5	6.4
711.2	28	914.4	36	190.5	7.5	82.55	3.25	139.7	5.5	3.3	6.4
		914.4	36	190.5	7.5	82.55	3.25	139.7	5.5	3.3	6.4
723.9	28.5	914.4	36	187.325	7.375	80.962	3.187	139.7	5.5	3.3	5.5

Basic load ratings		Limit speed ratings		Designations	Calculation coefficient				Weight
Cr	Cor	Grease	Oil		e	Y	Yo	a	
kN		r/min							kg
2540	7510	360	480	LM272249/LM272210D	0.33	2.03	3.02	1.98	130
3000	7600	340	440	EE640191/640261CD-2/C9	0.31	2.21	3.28	2.16	180
3000	7600	340	440	EE640192/640261CD	0.31	2.21	3.28	2.16	181
3000	7600	340	440	EE640192/640261CD-3	0.31	2.21	3.28	2.16	181
2100	5900	340	440	EE243196/243251CD/YA1	0.34	1.98	2.95	1.94	125
4500	13400	300	400	M274149/M274110CD	0.35	1.92	2.86	1.88	355
4500	13400	300	400	M274149/M274110DC	0.33	2	3	2	355
4650	11100	250	260	EE626210/626321CD	0.44	1.54	2.29	1.5	470
4650	11100	250	260	EE626210/626321D	0.44	1.54	2.29	1.5	470
4650	11100	250	260	EE626210/626321D-3	0.44	1.54	2.29	1.5	470
5650	15000	280	350	KM276449/KM276410CD/HCRYA1	0.33	2	3	2	426
5650	15000	280	350	M276449/M276410CD	0.33	2	3	2	426
5650	15000	280	350	M276449/M276410CD/YA1	0.33	2	3	2	427
2500	6150	280	350	KNAEE542215SW/K542291D	0.51	1.33	1.97	1.3	179
4400	12800	280	350	LM377449/LM377410CD	0.35	1.92	2.86	1.88	256
4400	12800	280	350	LM377449/LM377410CD/HE	0.35	1.92	2.86	1.88	256
6400	15900	260	330	M278749/M278710D	0.33	2	3	2	521
4000	10500	260	330	EE649240/649311CD	0.37	1.8	2.7	1.8	233
3080	9900	240	300	KL281148/KL281110CD	0.33	2	3	2	212
3080	9900	240	300	L281148/L281110CD	0.33	2.05	3.05	2	212
3300	10000	220	280	EE755280/755361CD	0.38	1.77	2.64	1.73	282
3300	10000	220	280	EE755280/755361D	0.38	1.77	2.64	1.73	282
3300	10000	200	280	KEE755285/K755361CD-2-JG	0.37	1.8	2.7	1.8	255

Note: * indicates the maximum value of IDor OD.

Double-row Tapered Roller Bearing(Inch DB)

d 723.9~914.4 mm

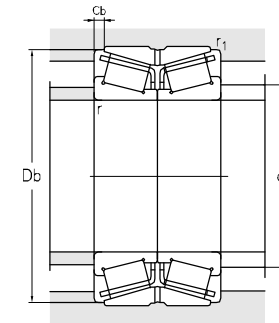
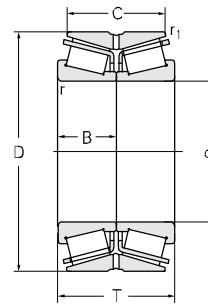
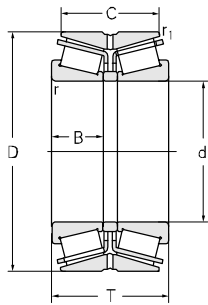

Principal dimensions

d		D		T		B		C		r _{1min1}	r _{min}
mm	in	mm	in	mm	in	mm	in	mm	in	mm	mm
723.9	30	914.4	36	187.325	7.375	80.962	3.187	139.7	5.5	3.3	5.5
		914.4	36	187.325	7.375	80.962	3.187	139.7	5.5	3.3	5.5
762	30	965.2	38	187.325	7.375	80.962	3.187	133.35	5.25	1.5	6.4
914.4	36	1066.8	42	139.7	5.5	63.5	2.5	101.6	4	3.3	6.4

Basic load ratings		Limit speed ratings		Designations	Calculation coefficient				Weight
C _r	C _{0r}	Grease	Oil		e	Y	Y ₀	a	
kN		r/min							kg
3300	10000	200	280	KEE755285/K755361D	0.38	1.77	2.64	1.73	255
3000	10000	200	280	KEE755285/K755361D-C3	0.38	1.77	2.64	1.73	255
3400	10000	180	260	KEE752300/K752381D	0.4	1.7	2.5	1.5	290
2350	7860	160	220	LL686947/LL686910D	0.41	1.64	2.5	1.6	180

Four-row Tapered Roller Bearing(Metric)

d 110.2~200 mm

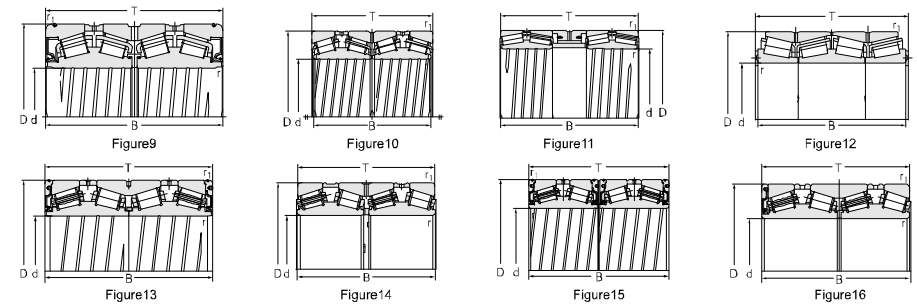
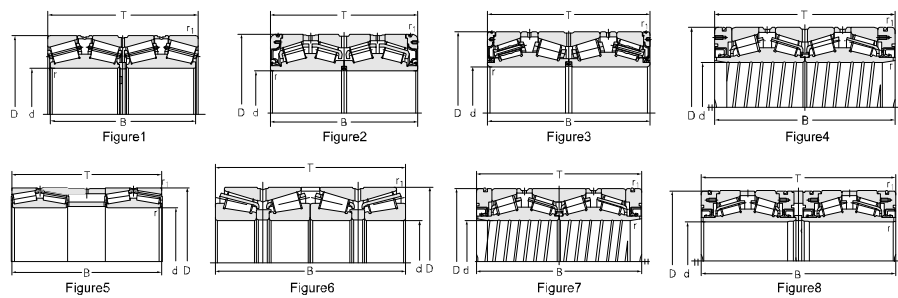

Principal dimensions

d	D	B	T	r _{min}	r _{1min}
mm					
110.2	170	176	176	2.5	2
120.65	166.88	152.413	152.413	0.8	3.3
139.7	200.025	157.162	160.338	1.1	1.8
	200.025	157.162	160.338	1.1	1.8
	200.025	74.581	157.162	1.1	1.8
	200.025	157.162	160.338	1.1	1.8
150	210	186	195	SP	2
	210	165	165	0.7	2.3
	210	165	165	0.7	2.3
	225	136	136	3	2.5
160.2	240	210	210	3	2.5
170	230	175	175	SP	SP
	260	230	230	3	2.5
177.8	273.05	234.95	234.947	1.5	3.3
180	250	190	190	2.5	0.7
	250	207	207	2.5	0.7
	250	190	190	2.5	0.7
	250	185	185	7.4*12.5*	2.5
	260	200	200	2.2	2
	260	200	200	2.5	2
	260	200	200	2.5	2
	280	180	180	3	2.5
190	260	200	200	2.5	2
	260	190	190	2.5	0.7
	260	190	190	2.5	0.7
200	280	206	206	1.5	3

Basic load ratings

C _r	C _{or}	Designations	Weight	Graph
kN				
kg				
670	1460	382022X4	14.6	1
590	1650	380624X4/C9	9.92	1
590	1870	3806/139.7/HCC	16.2	1
695	1870	3806/139.7/HCP59	16.2	1
695	1870	3806/139.7/HCP691	16.2	1
695	1870	3806/139.7/P5	16.2	1
850	2000	372930X2/HCC9DB/W281	19.1	5
660	1590	382930X2	21.2	1
660	1590	382930X2/C9	21.2	1
595	1460	382030X2	17.7	1
1230	2920	382032X4	32.9	1
920	2630	380634/HCC9	20.6	1
1030	3100	382034X2	43	1
1830	3750	3806/177X4/HCYAD	49.7	1
880	2290	352936X2A1/DF	26.7	6
790	2100	352936X2/DF-1	29.00	6
790	2100	352936X2/DF	27.30	6
980	2550	382936/HCC9YAD	26.5	1
1110	2700	382936X3	33.2	1
1110	2700	382936X3-1	33.2	1
1110	2700	382936X3/HCC9	33.7	1
920	2540	380636	39.6	1
1040	2780	382938X2-1/HCC9	29.6	1
1200	2690	382938X2/HCC	27.3	1
1200	2690	382938X2/HG2	27.3	1
1600	3410	380640/HCC9/W283	38.9	1

Four-row Tapered Roller Bearing(Metric)

d 200~220.663 mm

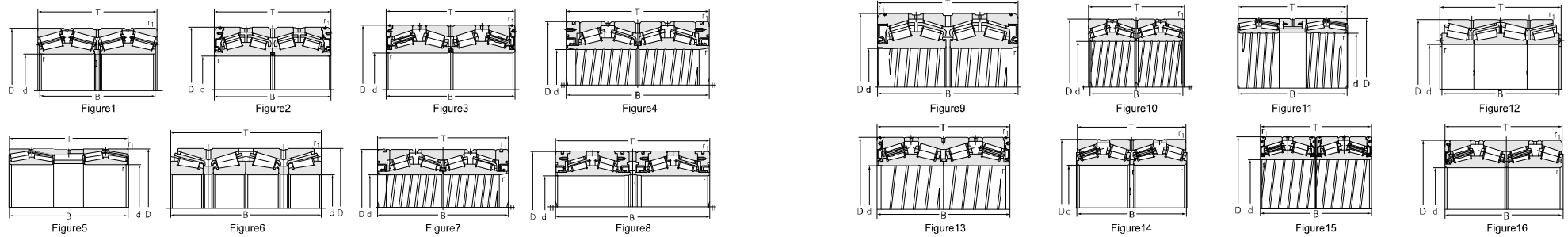

Principal dimensions

d	D	B	T	r _{min}	r _{1min}
mm					
200	280	206	206	3	2.5
	282	206	206	3	2.5
	282	206	206	1.5	2.5
	310	275	275	3	2.5
	310	200	200	3	2.5
	360	210	210	4	4
205	320	205	205	4	3
206.375	282.575	190.5	190.5	7*1	3.3
210	288.925	262	262	10*1.79	3
215.9	288.925	177.8	177.8	7*1	3.3
	288.925	177.8	177.8	7*1	3.3
220	295	315	315	SP	SP
	295	315	315	SP	SP
	295	315	315	SP	SP
	295	315	315	1.5	3
	300	230	230	3	2.5
300	230	230	3	2.5	
300	230	230	3	2.5	
310	220	220	3	2.5	
330	260	260	3	3	
340	305	305	4	3	
340	305	305	4	3	
220.662	314.325	290	290	1.5	3.3
	314.325	290	290	1.5	3.3
	314.325	239.712	239.712	3.8*1.5	3.3
220.663	314.325	330	330	3.8*1.5	3.2

Basic load ratings

C _r	C _{or}	Designations	Weight	Graph
kN			kg	
1280	3580	380640/HCYAD/W283	38.8	1
1280	3580	380640X1/HCYAD/W283	39.5	1
1040	2540	380640-2RS/HCEC9	37.6	2
1350	4200	382040	75.1	1
2170	1520	382040X2-1	55.6	1
1810	3290	382140X2/YB2	90.2	1
1160	2850	380641	55.4	1
1200	2790	3806/206X4-XRS/HC	32.7	2
1510	4050	380642-XRS/HCC9	49.3	S
1070	2440	3806/215.9-XRS/HCC9	30.7	2
1070	2440	3806/215.9-XRS/HCC9/W281	30.7	2
1580	3950	380644-2RS/HCEC9	56.4	2
1270	3780	380644-XRS/HC	56.6	8
1270	3780	380644-XRS/HCYAB	56.6	8
1470	3450	380644/W283	57.2	1
1570	4000	382944X2/HCE/W283-LG	47.9	1
1570	4000	382944X2/HCR	47.9	1
1550	4050	382944X2/HCYA3	47.9	1
1900	4400	380644X2/HCC2H/W283	53.1	1
2200	5300	380644/HC/W283	77.9	1
2800	5950	382044	99.5	1
2800	5950	382044/HC	99.5	1
2140	6150	3806/220X4/HC	73.2	1
2140	6150	3806/220X4/HCP59	73.2	1
1750	4150	380644X4-XRS/HC-1	57.4	2
1910	5480	380644X4-XRS/HC	80.4	4

Four-row Tapered Roller Bearing(Metric)

d 228~260 mm

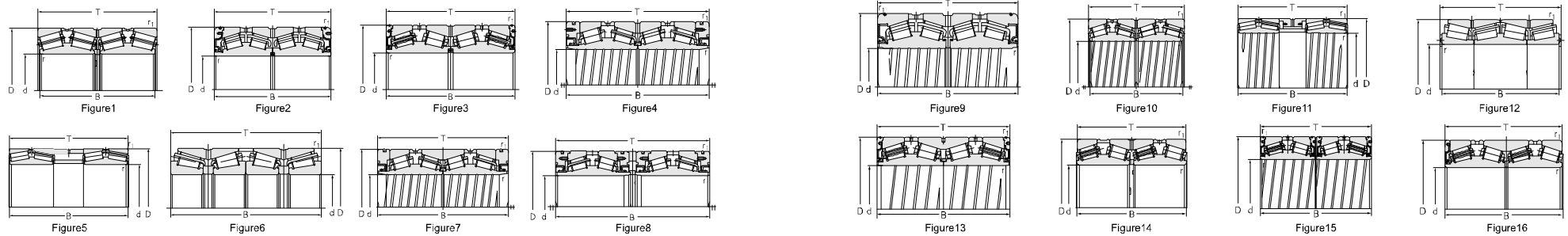

Principal dimensions

d	D	B	T	r _{min}	r _{1min}
mm					
228	338	340	340	10*15*	3.3
240	320	250	250	1.5	2.5
	320	294	294	7*2.06	4
	338	248	248	4	4
	338	248	248	4	4
	338	248	248	4	4
	338	118	248	6.4	6.4
	338	248	248	4	4
	338	248	248	4	4
	338	162	340	SP	3
	338	340	340	SP	4
	338	340	340	SP	4
	338	248	248	3	2.5
	350	230	230	1.5	2
	350	230	230	1.5	2
	360	310	310	4	3
	360	310	310	4	3
250	365	270	270	20*3.12	3
	385	255	255	5	5
	460	270	270	5	4
254	358.775	134.937	269.875	1.5	3.3
260	360	265	265	3	2.5
	360	272	272	3	2.5
	360	272	272	3	2.5
	360	272	272	3	2.5
	360	272	272	3	2.5
	360	272	272	3	2.5
365	340	340	20*1.75	3.5	
365	340	340	16*1	4	

Basic load ratings

C _r	C _{or}	Designations	Weight	Graph
kN				
2650	7130	3806/228-XRS/HCC9YAD	105	2
2100	5350	382948X2-1/HCC9/W283	56.5	1
1550	5000	382948X2-XRS/HC	61.6	4
2030	5400	380648/HCC9	69	1
2210	5950	380648/HCC9-1	69	1
2210	5950	380648/HCC9-3	69.2	1
2210	5950	380648/HCC9YAB	69	1
2210	5950	380648/HCEC9	69	1
2210	5950	380648/HCEC9-1	69	1
2210	5950	380648/HCEC9/W283-LG	69	1
1900	5160	380648X2-XRS/HCC9YAB	78.8	8
1900	5160	380648X2-XRS/HCRG2C9YAB	78.8	8
1900	5160	380648-XRS/HC	78.8	8
2050	5650	380648/C9-3	69.2	1
2050	4700	380648/HC-2	72.2	1
2050	4700	380648-2	72.2	1
3630	2210	382048X2	90.5	1
2400	6100	382048X2/HC	90.5	1
1950	4600	380650X1-XRS/HCC9	90.4	4
2310	5350	380650-1	107	1
2470	6400	380650/HC	192	1
1890	4950	3806/254-XRS/HC	80.5	2
1730	5050	382952/HC	77.8	1
2200	6500	382952X2/HCC2HYA23/W283	83.1	1
2200	6500	382952X2/HCC9YB2	83.1	1
2200	6500	382952X2/HCR	83.1	1
2600	6500	382952X2/HCYA3/W283	83.1	1
2500	6650	380652-XRS/HCC9YB2/W281	107	4
2900	7300	380652-XRS/HCEC9-1/W281	116	2

Four-row Tapered Roller Bearing(Metric)

d 260~300 mm

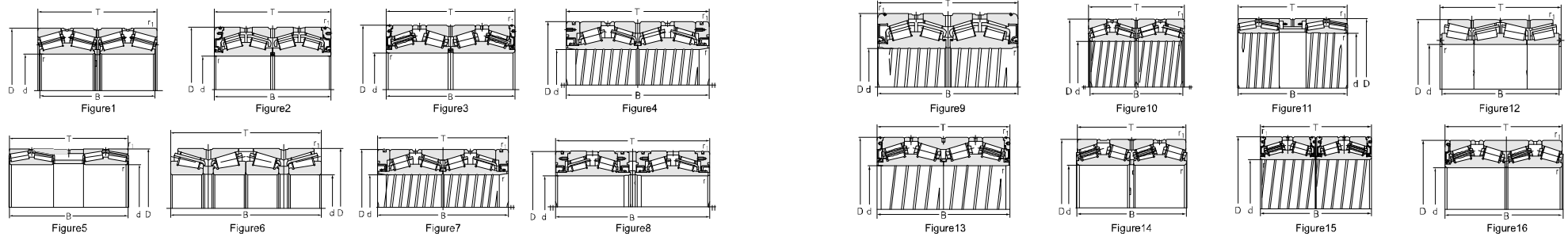

Principal dimensions

d	D	B	T	r _{min}	r _{1min}
mm					
260	365	340	340	20*1.75	3.5
	380	200	200	2	5
	380	280	280	4	7.5
	400	255	255	4	7.5
	400	255	255	4	7.5
	400	255	255	5	4
	400	345	345	5	4
	400	345	345	5	4
266.7	355.6	230.184	228.6	3.3*1.5	3.3
	355.6	230.184	228.6	3.3*1.5	3.3
	355.6	230.184	228.6	3.3*1.5	3.3
274.97	393.7	269.875	269.875	SP	6.4
279.4	393.7	320	320	SP	3.2
	393.7	269.875	269.875	1	6.4
280	395	290	290	SP	4
	395	340	340	SP	3.5
	395	288	288	4	7
	395	288	288	4	7
	420	250	250	5	5
	460	324	324	5	4
	300	420	300	300	4
420		300	300	4	3
420		310	310	4	3
424		148	310	4	3
460		390	390	5	4
460		360	360	5	4
460		390	390	5	4

Basic load ratings

C _r	C _{or}	Designations	Weight	Graph
kN				
2500	6650	380652-XRS/HCP59YAB	107	4
1870	4650	380652-2	76.9	1
2400	6400	380652X3/HC-FM	108	1
2250	4800	380652/HC-1	117	1
2050	4800	380652/HC	117	1
2100	4900	380652/HG2	117	1
2850	7700	382052	161	1
2850	7700	382052/HC	161	1
2670	5850	382152X2/HCYA6	182	1
1750	4450	3806/266.7-XRS/HC	58.9	2
1750	4450	3806/266.7-XRS/HCGP	58.9	2
1750	4450	3806/266.7-XRS/HC/W281	58.9	2
2600	5700	380655X4-XRS/HCEC9/W283	102	9
2500	7200	3806/279.4-XRS/HC	120	4
2200	5300	3806/279.4-XRS/HCYB2	98.3	2
2830	6550	380656-XRS/HC-1	109	2
3300	7600	380656-XRS/HCC9	125	2
2510	7060	382956X3/C9YAD	110	1
2990	7090	382956X3/HCC9YAD	110	1
1690	5300	380656	119	1
3680	8350	381156	219	1
2750	7500	382960/C9	125	1
2750	7500	382960/HC	125	1
2020	8100	382960X2/HCC9YA3	134	1
3300	8500	382960X3/HC	140	1
3850	10200	382060/HC	222	1
4450	9440	382060X2/HCYB2	217	1
4230	10200	382160/HC	222	1

Four-row Tapered Roller Bearing(Metric)

d 300~360 mm

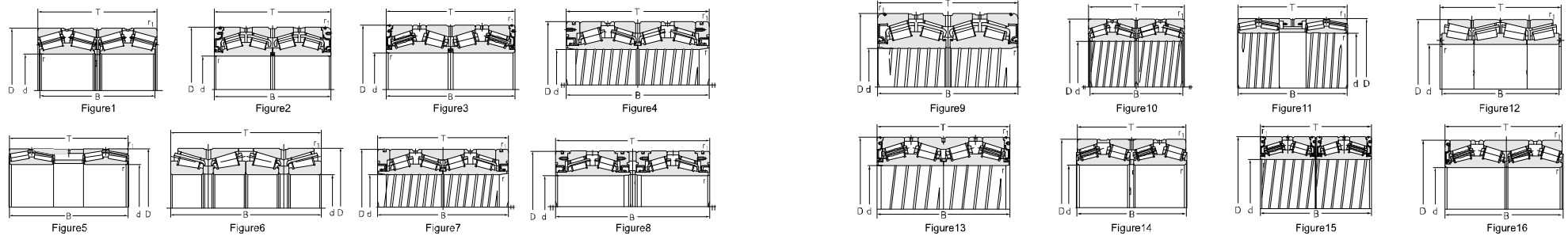

Principal dimensions					
d	D	B	T	r _{min}	r _{1min}
mm					
300	500	350	350	5	4
	500	350	350	5	4
	500	370	370	5	4
310	430	310	310	4	4
	430	310	310	15*10*	4
	430	310	310	11*11*	4
	430	350	350	16*5*	4
317.5	422.275		269.875	1.5	3.3
	422.275	269.875	269.875	1.5	3.3
320	480	380	380	5	4
330.2	444.5	301.625	301.625	3.3	3.3
335	460	342.9	342.9	3.3	3.3
340	460	310	310	4	4
	460	310	310	4	4
	460	310	310	4	4
	520	325	325	5	4
	520	323	323	6.7*9	6.6*8.4
	580	425	425	5	4
343.052	457.098	254	254	1	3.3
355	490	158	316	1.5	3.3
	490	158	316	1.5	3.3
355.6	482.6	265.114	269.875	1.5	3.3
	488.95		317.5	1.5	3.3
	488.95	317.5	317.5	1.5	3.3
360	480	370	370	9*20*	SP

Basic load ratings		Designations	Weight	Graph
C _r	C _{or}			
kN			kg	
2730	8900	380660/HCC9	280	1
4000	8900	380660/HCC91	280	1
3900	8800	381160/HC	282	1
3050	7900	380662/HCC9	135	1
2750	7000	380662-XRS/HC	131	2
3250	7950	380662-XRS/HC-2	133	2
3700	9450	380662-XRS/HCEC9-1/W281	154	2
2490	5950	3806/317.5-XRS/HCC9YAB	99.1	2
2490	5950	3806/317.5-XRS/HCC9YAB2	99.1	2
3300	11500	382064X2/HC	252	1
3240	7850	3806/330.2-XRS/HCC9	126	2
4000	10500	3806/335/HCZPC9	166	1
3000	8950	382968X2/HC	147	1
3000	8950	382968X2/HCC9	146	1
3350	8500	382968X2/HCEP6-AL	141	1
3520	8200	381068	247	1
3850	9060	381068X2/HCC9YA6	243	1
5150	12650	381168	468	1
2300	6000	3806/343X4-XRS/HCC9-LG	108	2
4460	10000	380671/HC	175	1
4460	10000	380671/HCC9	175	1
2570	7440	3806/355.6/HCC9	139	10
4750	11000	3806/355X4-2RS/HCC9	165	2
4750	11000	3806/355X4-2RS/HCC9/W281	165	2
4100	11000	370672/HCC9DBYAD	177	5

Four-row Tapered Roller Bearing(Metric)

d 360~400 mm

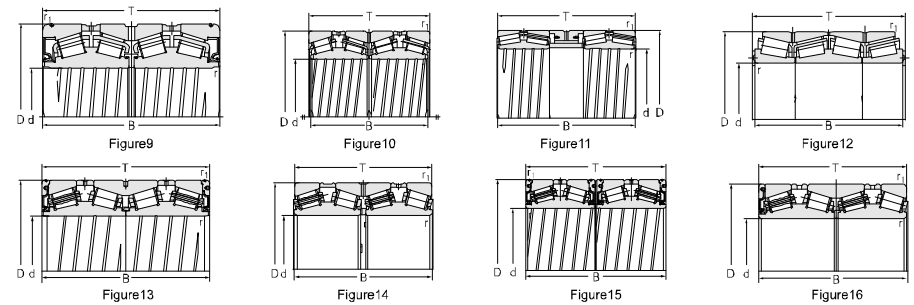
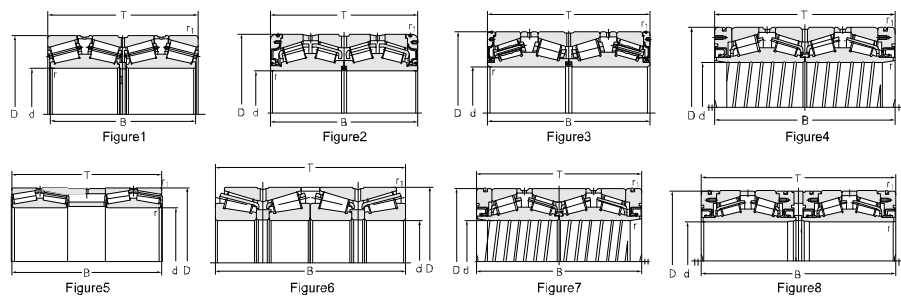

Principal dimensions

d	D	B	T	r _{min}	r _{1min}
mm					
360	480	370	370	9*20*	SP
	480	310	310	4	3
	480	375	375	4	4
	600	420	420	4.7	4.7
380	536	390	390	SP	SP
	550	330	350	5	5
	560	325	325	5	4
	620	388	388	6	6
	620	420	420	5	4
	620	420	420	5	4
	620	420	420	5	4
	620	420	420	5	4
384.175	546.1	400.05	400.05	SP	6.4
385.762	514.35	317.5	317.5	SP	5
390	510	350	350	1.5*3.8	5.5*3
	540	530	530	9*4	7.5*4
395	545	268	288.9	5	10
	545	268.7	288.7	4	7.5
	545	268.7	288.7	4	7.5
	545	268.7	288.7	4	7.5
400	540	280	280	3.7	7.5
	540	400	400	5	5
	540	400	400	5	5
	540	280	280	3.7	7.5
	540	339.96	339.96	SP	1.5
	540	400	400	5	5
	540	280	280	3.7	7.5
	540	400	400	SP	5

Basic load ratings

C _r	C _{or}	Designations	Weight	Graph
kN				
kg				
4100	11000	370672/HCEC9DBYAD	177	5
2870	9000	382972/HC	155	1
2550	11800	382972X2/HCYA3	197	1
3950	13500	381172/HCYA6	423	1
5000	12900	380676/HCC9-2	270	1
2490	9450	380676/HC-1	273	1
4810	10000	381076	263	1
3450	11600	380676/HC	443	1
5050	12600	381176/HC	485	1
5050	12600	381176/HCC9	485	1
5050	12600	381176/HCW33	485	1
5050	12600	381176/HCYA2	484	1
5200	12000	HM266449DW/HM266410-HM266410D-XRS/C9YB2	293	2
3750	9900	3806/385X4-XRS/HCEC9	177	2
3750	12100	380678/HCEC9-HBIS	184	1
5050	14000	370678/HCC9DBYAD	366	1
2130	6500	380679/HCYA3	194	1
2130	6500	380679X2/HC	194	1
2130	6500	380679X2/HCC9	194	1
2130	6500	380679X2/HCYA7	194	1
2690	6500	380680/HC-1	187	1
6350	13300	380680/HC	262	1
6350	13300	380680/HCC9	262	1
2690	6500	380680/HCEC9YA6-1	187	1
4650	11700	380680/HCEC9YAD	214	12
6350	13300	380680/HG2	262	1
2450	6500	380680X2-XRS/HCC9	179	2
6050	12300	380680-XRS/HCC9	248	2

Four-row Tapered Roller Bearing(Metric)

d 400~440 mm

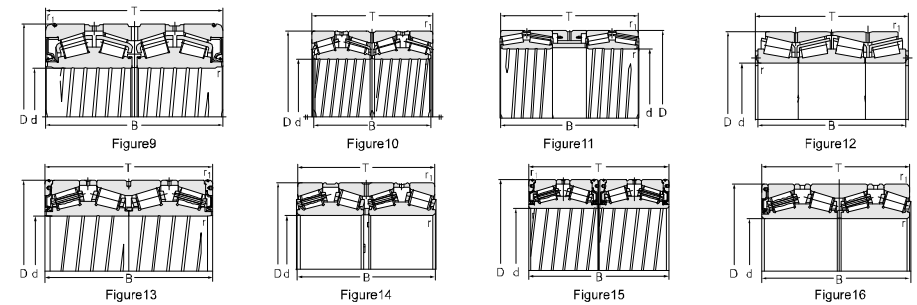
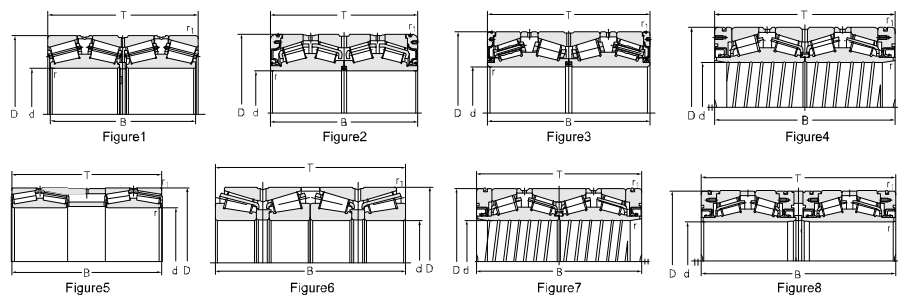

Principal dimensions

d	D	B	T	r _{min}	r _{1min}
mm					
400	600	356	356	5	4
	600	356	356	5	4
406.4	546.1	288.925	288.925	1.5	6.4
	562	381	381	3.3	6.4
	562	381	381	1.5	SP
	562	381	381	4	SP
	562	381	381	SP	3.3
409.575	546.1	334.962	334.962	1.5	6.4
420	560	437	437	5	5
	560	437	437	5	5
	560	437	437	5	5
	560	437	437	SP	6
	592	432	432	5	5
	592	432	432	5	5
	620	356	356	5	4
	700	480	480	6	5
	700	480	480	6	5
	700	480	480	6	5
440	590	480	480	3	5
	590	480	480	3	5
	590	480	480	SP	SP
	590	480	480	3	5
	620	454	454	6	6
	620	454	454	6	6
	620	454	454	6	6
	620	454	454	6	6
	620	454	454	6	6
	620	454	454	6	6
	620	454	454	6	6
	620	454	454	6	6
	620	454	454	SP	7.5

Basic load ratings

C _r	C _{or}	Designations	Weight	Graph
kN				
kg				
4950	12400	381080/HC	345	1
4950	12400	381080/HCRG2C9	345	1
4020	10500	3806/406X4/HC/W281	191	1
4620	13900	3806/406.4/HCC9YB2	283	1
4900	13500	3806/406X4-XRS/HCC9	229	2
4900	13500	3806/406X4-XRS/HCC9YAD	229	2
4900	13500	3806/406X4-XRS/HCC9YAD-1	283	2
4650	12000	3806/409X4/HCEC9	214	10
7900	16300	380684/HC	298	1
4940	16300	380684/HCC3	298	1
4940	16300	380684/HCC9	298	1
4800	15200	380684-XRS/HCP69	292	2
6600	16300	380684/HC-1	375	1
6600	16300	380684/HCE-1	375	1
4560	11700	381084	369	1
10500	11900	381184	755	3
9560	11900	381184/HCW33	755	3
5610	18200	381184X2J/HC	749	1
8000	19000	381188X1-2RS/HCC9	359	2
8000	19000	381188X1-2RS/HCC9/W281	359	2
8000	19000	381188X1-XRS/HC-1	359	2
8000	19000	381188X1-XRS/HC	359	2
6650	18800	380688/HC-1	432	1
6650	18800	380688/HC-1C9	432	1
6650	18800	380688/HCC9	432	1
6050	18800	380688/HCC9-1	432	1
6050	18800	380688/HCC9-2	432	1
6500	20200	380688/HCC9YA8	422	3
6750	16700	380688-XRS/HCC9	408	13

Four-row Tapered Roller Bearing(Metric)

d 440~490 mm

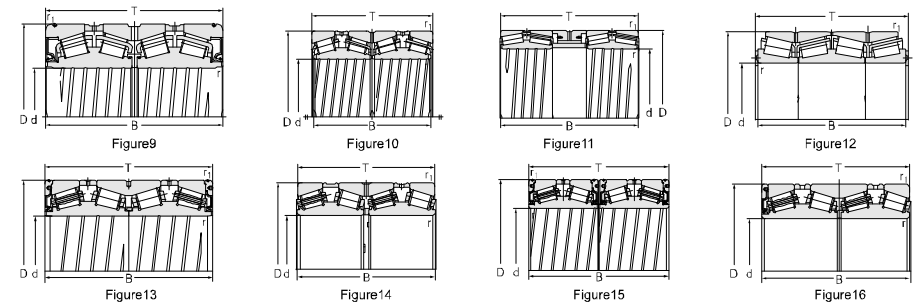
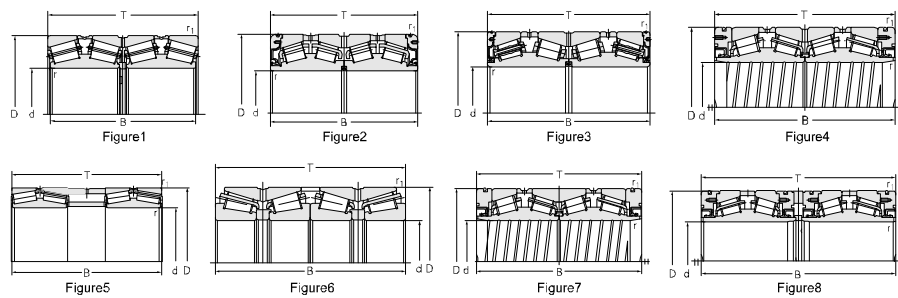

Principal dimensions

d	D	B	T	r _{min}	r _{1min}	
mm						
440	650	355	355	6	5	
	650	355	355	6*	5*	
	650	355	355	4	5	
	650	376	376	6	5	
	650	355	355	6	5	
	650	355	355	6	5	
450	595	415	415	SP	6	
	595	415	415	9*20*	6	
	595	350	350	6	1.5	
	595	368	368	3	6	
	595	368	368	SP	5	
	460	590	360	360	SP	SP
610		360	360	3	6	
610		360	360	3	6	
620		310	310	5	4	
620		310	310	5	4	
650		474	474	6	6	
730		440	440	4	7.5	
475		600	368	368	2	6
		620	380	380	2	6
480		678	494	494	6	6
	700	420	420	5	5	
	700	420	420	6	5	
482.6	615.95	400	400	SP	6.4	
488.95	622.3	365.125	365.125	3.8	6.4	
490	625	385	385	7*3	4	
	625	385	385	7*3	4	
	625	385	385	SP	6	

Basic load ratings

C _r	C _{or}	Designations	Weight	Graph
kN				
kg				
4900	12000	380688	385	1
3680	12100	380688/HC	385	1
4550	12300	380688/HCYA7	385	1
4900	13800	381088/HC	420	1
4550	12300	381088X2/HC	403	3
4550	12300	381088X2/HG2	403	3
4900	16700	370690X2/HCC9DB	305	5
4900	16700	370690X2/HCC9DB/W281	305	5
5350	14700	380690/HC	285	6
6300	16000	380690/HCEC9-1	281	10
5250	13400	380690-XRS/HC	268	2
5100	14400	380692/HCEC9YAD	241	1
6100	16400	381992X3/HC	291	10
6100	16400	381992X3/YA	291	10
3650	10000	381992/HC	260	1
3650	10000	381992/HCC9	260	1
4500	20000	380692/HCC9-1	506	1
5600	14800	381192X3/HC	663	1
4700	15600	3806/475/HCC9YB2	243	1
5000	16200	380695/HCC9YB2	298	1
9130	23800	380696/HC	571	1
4730	16900	381096	582	3
5880	15500	381096/HCYA2	535	1
4700	16000	3806/482.6-XRS/HCEC9YAB	299	2
4600	16200	3806/488X4/HC-TZ	267	1
4900	16500	380698/HC	278	1
4900	16500	380698/HCYA2	278	1
5200	14350	380698-XRS/HCEC9YAD	275	2

Four-row Tapered Roller Bearing(Metric)

d 490~600 mm

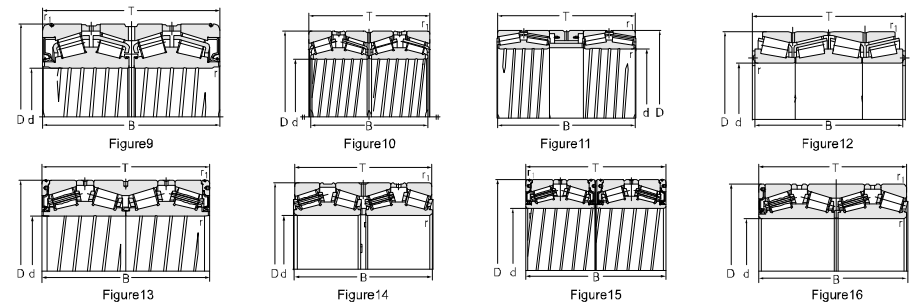
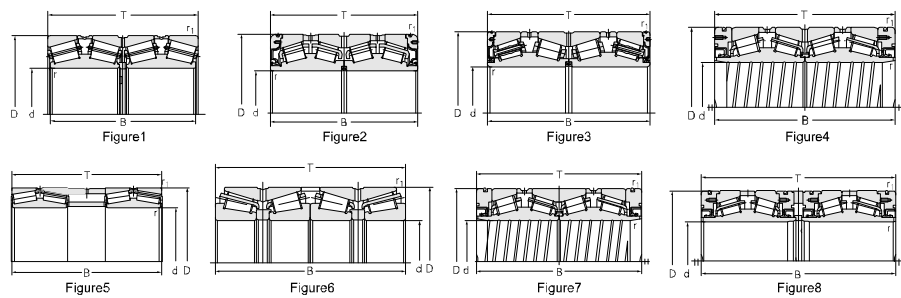

Principal dimensions

d	D	B	T	r _{min}	r _{1min}
mm					
490	625	385	385	SP	4
500	720	400	400	5	5
501.65	673.1	400.05	387.35	3.3	6.4
510	655	377	379	1.5	6.4
	655	377	379	1.5	6.4
514.35	673.1	422.275	422.275	SP	6.4
520	740	540	540	5	6
530	730	515	535	5	5
	780	450	450	6	5
	780	450	450	6	5
540	690	400	400	2	5
558.8	736.6	409.575	409.575	SP	6.4
	736.6	409.575	409.575	3.3	6.4
	736.6	409.575	409.575	SP	6.4
	736.6	450	450	5	5
	736.6	455.612	457.2	3.3	6.4
560	750	368	368	5	4
	920	620	620	7.5	6
570	780	515	515	SP	6
595.312	844.55	615.95	615.95	3.3	6.4
596.9	980	604.838	609.6	6.4	12.7
600	800	365	365	5	5
	800	380	380	5	4

Basic load ratings

C _r	C _{or}	Designations	Weight	Graph
kN				
kg				
5200	14350	380698-XRS/HCEC9YB2	275	2
7500	18600	3810/500X2/HC	542	3
6450	17100	3806/501X4/HC	381	10
5500	16200	3806/510/HCC9	316	10
5150	14700	3806/510-XRS/HCC9YAD	305	2
5320	17100	3806/514X4-XRS/HCC9	379	2
8350	24500	3806/520/HCC9-1	728	1
10200	27400	3806/530/HCYAB	666	1
7200	18200	3810/530	745	3
6550	18200	3810/530/HC	742	3
5700	11400	3806/540J/HC	375	1
6500	20000	3806/558X4-2RS/HCC9	456	3
6500	20000	3806/558X4-2RS/HCC9-1	456	3
6500	20000	3806/558X4-2RS/HCC9/W281	456	3
7250	23600	3806/558X4/HC	534	14
8140	23200	3806/558X4-XRS/HCEC9-1/W281	517	2
7850	15800	3819/560/HC	447	3
20000	32000	3811/560	1690	1
9200	28100	3806/570/HCC9YAB	730	3
13600	36900	3806/595X4/HCC9YAB	1125	1
16100	33700	3806/596.9/HC	1760	14
4000	18100	779/600	489	1
4400	18100	3819/600/HC	497	1

Four-row Tapered Roller Bearing(Metric)

d 600~670 mm

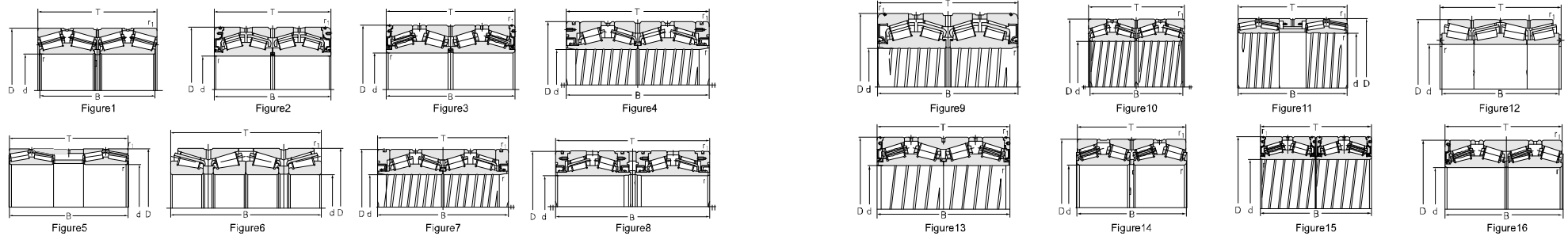

Principal dimensions

d	D	B	T	r _{min}	r _{1min}
mm					
600	800	380	380	5	4
	800	365	365	5	5
	800	365	365	5	5
	870	480	480	6	6
	980	650	650	7.5	7.5
609.6	787.4	361.95	361.95	3.3	6.4
625	815	480	480	3.5	6.5
	815	480	480	3.5	6.5
	815	480	480	3.5	6.5
630	850	418	418	6	6
	850	418	418	6	6
	860	615	615	6.5	6.5
	860	615	615	5	5
	920	515	515	7.5	7.5
	1030	670	670	7.5	6
646.112	857.25	542.925	542.925	3.3	6.4
647.7	1028.7	558.8	558.8	7.5	12
	1028.7	558.8	558.8	7.5	12
650	1030	560	560	7.5	12
	1030	560	560	7.5	12
	1030	560	560	7.5	12
	1030	560	560	7.5	12
	1030	560	560	7.5	12
660.011	855.015	319.99	319.99	SP	5.2
670	900	412	412	6	6
	900	412	412	6	6

Basic load ratings

C _r	C _{or}	Designations	Weight	Graph
kN				
5800	18100	3819/600/HCRG2	497	1
4400	18100	3806/600/HC	489	1
5110	17200	3806/600/HCYA8	521	3
8900	27500	3810/600HC	990	3
9650	37500	3811/600/HC	1950	3
7800	19000	EE649241D/649310-649311D-XRS	411	2
9720	28900	3806/625/GW/HC	658	10
9720	28900	3806/625GW/HC/W281	658	10
9720	28900	3806/625/HC	658	10
6700	22200	3819/630/HC	683	14
7650	22500	3819/630/HCC9YAD	668	1
8810	28500	3806/630/HC	1020	1
13300	37000	3806/630-XRS/HCC9	1034	2
6550	27500	3810/630/HC	1190	14
16500	42000	3811/630/HC	2200	14
9250	29100	3806/646X4-XRS/HCC9	837	2
15000	30000	EE424257X2D/424405X2-424406X2D	1731	14
15000	30000	EE424257X2D/424405X2-424406X2D/W283	1731	14
16020	39300	777/650UY	1712	14
17600	39300	3806/650/HC	1720	14
17600	39300	3806/650/HCC9	1723	14
16000	39300	3806/650/HCYA7	1770	14
16000	39300	3806/650/HCYAD	1735	14
4750	17000	3806/660X4/HC	495	14
5250	24600	3819/670/HC	773	14
5250	24600	3819/670/HCR	773	14

Four-row Tapered Roller Bearing(Metric)

d 676~750 mm

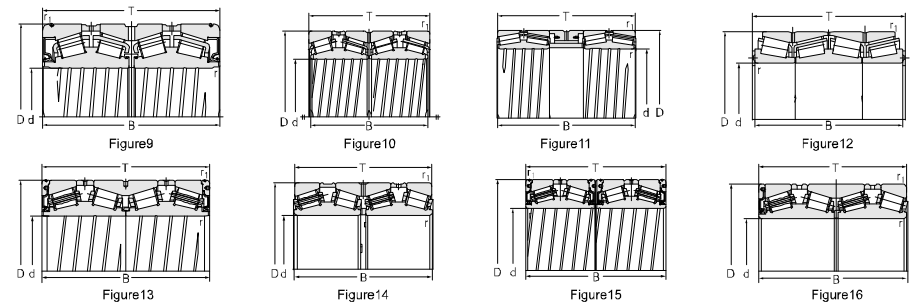
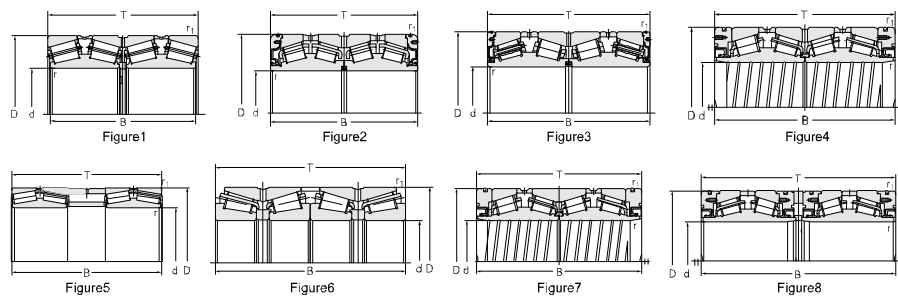

Principal dimensions

d	D	B	T	r _{min}	r _{1min}
mm					
676	910	620	620	4	8
680	930	700	700	3	6
685.8	876.3	352.425	355.6	6.4	6.4
707	914.4	552.45	552.45	3	SP
710	900	410	410	3	6
	900	410	410	3	7.5
	900	410	410	3	7.5
	900	410	410	3	6
	900	410	410	3	6
	900	410	410	3	6
	900	410	410	4	7.5
711.2	914.4	390	420	SP	6.4
	914.4	390	420	SP	5
	914.4	390	420	SP	5
	914.4	387.35	387.35	SP	6.4
	914.4	387.35	387.35	SP	6.4
	914.4	390	390	SP	7.5
730	940	500	500	3.5	8
	1035	755	755	3.3	6.4
				1.1	7.5
749.3	990.6	605	605	4	8
750	950	410	410	6	6
	1130	690	690	7.5	9.5
	1220	840	840	9.5	8
	1220	840	840	6	13
	1220	840	840	9.5	9.5
	1220	840	840	9.5	9.5
	1220	840	840	9.5	9.5
	1220	840	840	9.5	9.5

Basic load ratings

C _r	C _{or}	Designations	Weight	Graph
kN				
11000	37500	3806/676/HCYA3	1162	14
16900	52300	3806/621X4K/HC	1665	14
5800	14500	3806/685.8-XRS/HCC9	490	7
8900	30700	3806/704.85-XRS/HCC9	900	2
7850	27400	779/710	650	14
8400	24100	3806/710-2RS/HCC9	619	13
8400	24100	3806/710-2RS/HCC9/W281	619	13
9250	26400	3806/710/HCC9YAD	601	1
8080	27400	3806/710/HCEYB2	643	1
5880	27500	3806/710/HCYA2	650	1
8400	24100	3806/710-XRS/HCC9	620	2
6200	19400	3806/711.2-XRS/HCEC9	671	7
6200	19400	3806/711.2-XRS/HCEP59	671	7
7900	20100	3806/711X4-XRS	674	13
7900	20100	3806/711X4-XRS/HCC91YAD	614	13
7900	20100	3806/711X4-XRS/HCC91YAD-1	622	13
7900	20100	3806/711X4-XRS/HCE	620	13
7900	20100	3806/711X4-XRS/HCEC9YB2	622	13
11000	33000	3806/730/HCEYB2-1	868	14
20500	58500	3806/730/HCYB2	2120	14
13000	45300	3806/749.3/HC-JG	1284	14
9560	27780	3806/750/HCEC9	703	14
1680	49000	3810/750X3/HC	2490	14
21800	63000	3711/750X2-2RS/HCP69DB	3920	15
21100	70500	3806/780/HCC9	3810	14
17700	68500	3811/750	3985	14
30500	71500	3811/750/HCE	3979	14
24600	64500	3811/750-RS/HCC9	3880	16

Four-row Tapered Roller Bearing(Inch)

d 127~220.662 mm

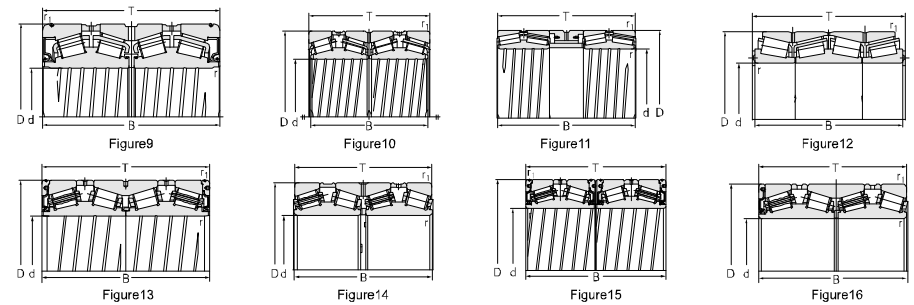
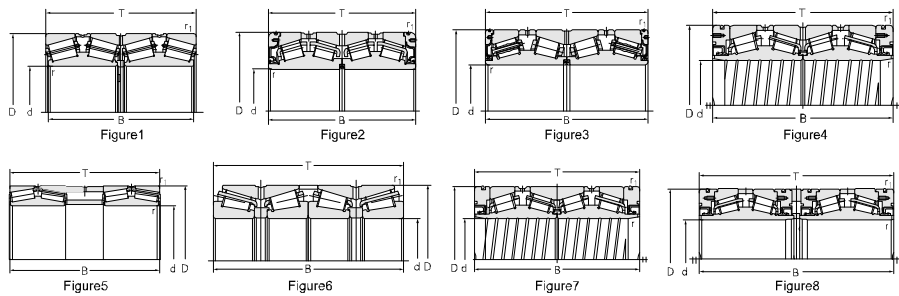

Principal dimensions								Chamfer dimensions			
d		D		T		B		r _{min} radial	r _{min} axial	r _{1min} radial	r _{1min} axial
mm	in	mm	in	mm	in	mm	in	mm			
127	5	182.562	7.1875	158.75	6.25	158.75	6.25	1.5	1.5	3.3	3.3
120.65	4.75	174.625	6.875	139.703	5.5	141.288	5.563	0.8	0.8	1.5	1.5
133.35	5.25	196.85	7.75	193.675	7.625	193.675	7.625	1.5	1.5	3.3	3.3
		196.85	7.75	193.675	7.625	193.675	7.625	1.5	1.5	3.3	3.3
136.525	5.375	190.5	7.5	161.925	6.375	161.925	6.375	1.5	1.5	3.3	3.3
177.8	7	247.65	9.75	192.088	7.562	192.088	7.5625	1.5	1.5	3.3	3.3
187.325	7.375	269.875	10.625	211.138	8.3125	211.138	8.3125	1.5	1.5	3.3	3.3
		269.875	10.625	211.138	8.3125	211.138	8.3125	1.5	1.5	3.3	3.3
		269.875	10.625	211.138	8.3125	211.138	8.3125	1.5	1.5	3.3	3.3
190.5	7.5	266.7	10.5	188.912	7.437480315187.325	187.325	7.375	1.5	1.5	3.3	3.3
198.438	7.8125	284.162	11.1875	225.425	8.875	225.425	8.875	1.5	1.5	3.3	3.3
204.127	8.0365	314.325	12.375	255.588	10.0625	255.588	10.0625	3.3	3.3	1.5	1.5
206.35	8.124	365.125	14.375	228.6	9	228.6	9	3.3	3.3	6.4	6.4
206.375	8.125	282.575	11.125	190.5	7.5	190.5	7.5	0.8	0.8	3.3	3.3
		282.575	11.125	190.5	7.5	190.5	7.5	0.8	0.8	3.3	3.3
		282.575	11.125	190.5	7.5	190.5	7.5	0.8	0.8	3.3	3.3
206.375		282.575	11.125	190.5	7.5	190.5	7.5	0.8	0.8	3.3	3.3
		282.575	11.125	190.5	7.5	190.5	7.5	0.8	0.8	3.3	3.3
		282.575	11.125	190.5	7.5	190.5	7.5	0.8	0.8	3.3	3.3
220.662	8.6875	314.325	12.375	239.712	9.4375	239.712	9.4375	1.5	1.5	3.3	3.3
		314.325	12.375	239.712	9.4375	239.712	9.4375	1.5	1.5	3.3	3.3
		314.325	12.375	239.712	9.4375	239.712	9.4375	1.5	1.5	3.3	3.3
		314.325	12.375	239.712	9.4375	239.712	9.4375	3.8	1.5	3.3	3.3

Basic load ratings		Designations	Weight Graph	
C _r	C _{or}		kg	
kN				
690	1790	48290DW/48220-48220D/W283	13.2	1
615	1460	KM224749D/KM224710-KM224710D-3	11.1	1
970	2370	K67390D/K67322-K67322D	20.2	1
970	2370	K67390D/K67322-K67322D-3	20.2	1
720	1820	48393DW/48320-48320D/W283	13.8	1
1070	3000	K67791DGW/K67720-K67721D	28.6	1
1570	3430	KM238849D/KM238810-KM238810D	41.5	1
1250	3440	M238849D/M238810-M238810CD/HOC2H/W283	41.5	1
1250	3440	M238849D/M238810-M238810D	41.5	1
1050	3030	K67885D/K67820-K67820D/C9YB2	32.8	1
1880	4200	M240648DW/M240611-M240611D	46.6	1
2100	4650	M244230T-M244247TD-M244249T/M244210DX2	65.1	12
1900	4580	EE134102D/134143-134144CD-3	71.8	1
1030	2830	67986D/67920-67921D	34.4	1
1030	2830	67986D/67920-67921D-2	34.4	1
1030	2830	67986D/67920-67921D-3/C9	34.4	1
1030	2830	67986D/67920-67921D/W283	34.4	1
1030	2830	K67986DGW/K67920-K67921D-2	34.4	1
1030	2830	K67986D/K67920-K67921D	34.4	1
2090	4900	KM244249D/KM244210-KM244210D	60.2	1
2000	4500	M244249DGW/M244210-M244210CD/C9	60.2	1
2000	4500	M244249DGW/M244210-M244210D/HEC9	59.8	1
1750	4150	M244249DGW/M244210-M244210D-XRS	57.4	2

Four-row Tapered Roller Bearing(Inch)

d 220.662~279.4 mm

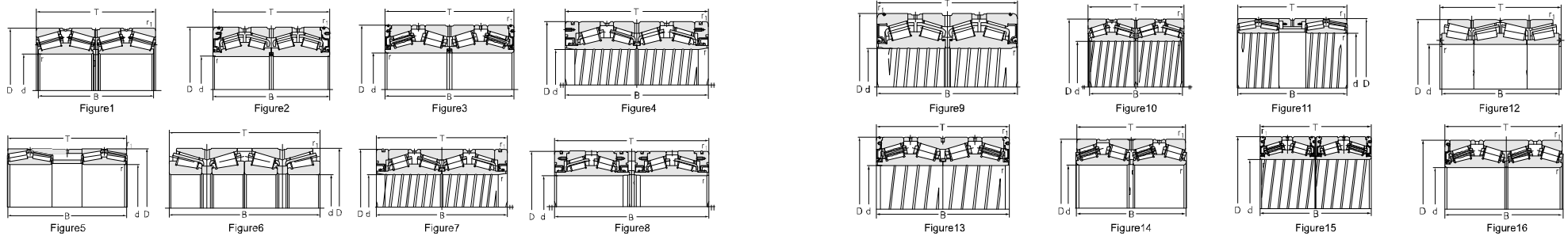

Principal dimensions								Chamfer dimensions			
d		D		T		B		r _{1min} radial	r _{1min} axial	r _{1min} radial	r _{1min} axial
mm	in	mm	in	mm	in	mm	in	mm			
220.662		314.325	12.375	239.712	9.4375	239.712	9.4375	1.5	1.5	3.3	3.3
		314.325	12.375	239.712	9.4375	239.712	9.4375	1.5	1.5	3.3	3.3
		314.325	12.375	239.712	9.4375	239.712	9.4375	1.5	1.5	3.3	3.3
228.6	9	311.15	12.25	200.025	7.875	200.025	7.875	1.5	1.5	3.3	3.3
		311.15	12.25	200.025	7.875	200.025	7.875	1.5	1.5	3.3	3.3
241.478	9.507	349.148	13.746	228.6	9	228.6	9	1.5	1.5	3.3	3.3
244.475	9.625	381	15	304.8	12	304.8	12	7.5	3.3	8.5	4.8
		327.025	12.875	193.675	7.625	193.675	7.625	1.5	1.5	3.3	3.3
		327.025	12.875	193.675	7.625	193.675	7.625	3.3	1.5	3.3	3.3
		327.025	12.875	193.675	7.625	193.675	7.625	3.3	1.5	3.3	3.3
		327.025	12.875	193.675	7.625	193.675	7.625	3.3	1.5	3.3	3.3
254	10	358.775	14.125	269.875	10.625	269.875	10.625	3.3	3.3	3.3	3.3
		358.775	14.125	269.875	10.625	269.875	10.625	3.3	3.3	3.3	3.3
		358.775	14.125	269.875	10.625	269.875	10.625	3.3	3.3	3.3	3.3
		358.775	14.125	269.875	10.625	269.875	10.625	3.3	3.3	3.3	3.3
254		358.775	14.125	269.875	10.625	269.875	10.625	3.3	3.3	3.3	3.3
		358.775	14.125	269.875	10.625	269.875	10.625	3.3	3.3	3.3	3.3
		358.775	14.125	269.875	10.625	269.875	10.625	1.5	1.5	3.3	3.3
266.7	10.5	355.6	14	228.6	9	230.188	9.063	1.6	1.6	3.2	3.2
		355.6	14	230.188	9.0625	228.6	9	3.3	1.5	3.3	3.3
		355.6	14	230.188	9.0625	228.6	9	3.3	1.5	3.3	3.3
		355.6	14	230.188	9.0625	230.188	9.063	3.3	1.5	3.3	3.3
269.875	10.625	381	15	282.575	11.125	282.575	11.125	3.3	3.3	3.3	3.3
		381	15	282.575	11.125	282.575	11.125	3.3	3.3	3.3	3.3
279.4	11	393.7	15.5	269.875	10.625	269.875	10.625	1.5	1.5	6.4	6.4
		393.7	15.5	269.875	10.625	269.875	10.625	1.5	1.5	6.4	6.4
		393.7	15.5	269.875	10.625	269.875	10.625	1.5	1.5	6.4	6.4

Basic load ratings		Designations	Weight Graph	
C _r	C _{or}		kg	
kN				
1790	4900	M244249D/M244210-M244210D-2/C9 M244249D/M244210-M244210D/C9W283 M244249DW/M244210-M244210D/HEC9	60.2	1
1790	4900		58.8	1
2160	4900		60.2	1
1560	3650	LM245149DGW/LM245110-LM245110D LM245149D/LM245110-LM245110D	43.9	1
1560	3650		43.9	1
1800	4350	EE127097DW/127135-127136CD/YA10-3	71.9	1
2700	5900	EE126096DGWA6/126150A6-126151D/C9 KLM247748DGW/KLM247710-KLM247710D/HG2-3 KLM247748DW/KLM247710-KLM247710D LM247748DW/LM247710-LM247710D LM247748DW/LM247710-LM247710D-3	124	1
1450	4050		44	1
1740	3930		42.7	1
1740	4050		42.7	1
1450	4050		44	1
2720	6050	K3M249748DW/K3M249710-K3M249710D-3 KRM249748D/M249710-M249710D KRM249748DW/M249710-M249710D M249748D/KM249710-KM249710D	88.9	1
2080	6050		86.8	1
2080	6050		86.8	1
2080	6050		86.8	1
2720	6050	M249748D/M249710-M249710D M249748DW/M249710-M249710D/W283-LG M249749D/M249710-M249710CD	88.9	1
2080	6050		86.8	1
2230	6150		86.8	1
1700	4800	K76589D/K76520-K76520D KLM451349DW/KLM451310-KLM451310D LM451349DW/LM451310-LM451310D LM451349DW/LM451310-LM451310D-WY	59.6	1
1950	5560		65.3	1
1950	5800		63.9	1
2110	5140		61.5	1
2930	7550	M252349DW/M252310-M252310D M252349DW/M252310-M252310D-3	105	1
2340	7550		105	1
2040	6200	EE135111D/135155-135156D EE135111D/135155-135156D-2/C91 EE135111DW/135155-135156DW	103	1
2040	6200		103	1
2040	6200		103	1

Four-row Tapered Roller Bearing(Inch)

d 279.4~341.312 mm

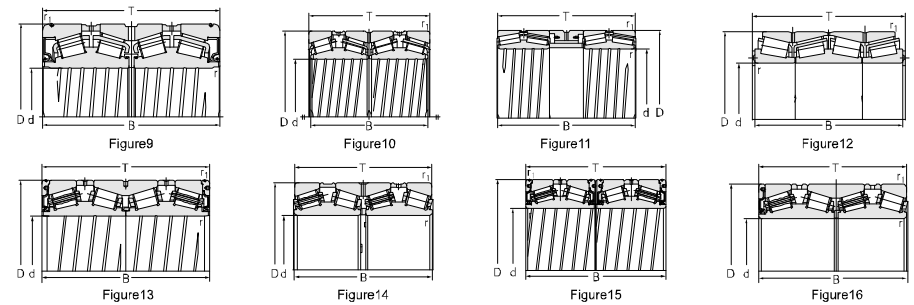
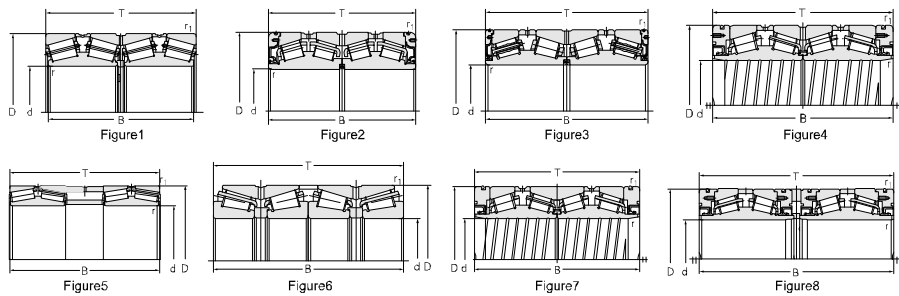

Principal dimensions								Chamfer dimensions			
d	D		T		B		r _{1min} radial	r _{1min} axial	r _{1min} radial	r _{1min} axial	
mm	in	mm	in	mm	in	mm	in	mm	in	mm	
279.4		393.7	15.5	269.875	10.625	269.875	10.625	1.5	1.5	6.4	6.4
		393.7	15.5	269.875	10.625	269.875	10.625	1.5	1.5	6.4	6.4
		393.7	15.5	269.875	10.625	269.875	10.625	1.5	1.5	6.4	6.4
		393.7	15.5	269.875	10.625	269.875	10.625	1.5	1.5	6.4	6.4
285.75	11.25	380.898	14.996	244.475	9.625	244.475	9.625	3.8	1.5	5.5	3.3
		244.475	9.625	244.475	9.625	3.8	1.5	5.5	3.3		
288.925	11.375	406.4	16	298.45	11.75	298.45	11.75	3.3	3.3	3.3	3.3
		406.4	16	298.45	11.75	298.45	11.75	3.3	3.3	3.3	3.3
		406.4	16	298.45	11.75	298.45	11.75	3.3	3.3	3.3	3.3
288.925		406.4	16	298.45	11.75	298.45	11.75	3.3	3.3	3.3	3.3
		406.4	16	298.45	11.75	298.45	11.75	3.3	3.3	3.3	3.3
		406.4	16	298.45	11.75	298.45	11.75	3.3	3.3	3.3	3.3
300.038	11.8125	422.275	16.625	311.15	12.25	311.15	12.25	3.3	3.3	3.3	3.3
		422.275	16.625	311.15	12.25	311.15	12.25	3.3	3.3	3.3	3.3
304.648	11.994	438.048	17.246	279.4	11	279.4	11	3.3	3.3	4.8	4.8
		438.048	17.246	279.4	11	279.4	11	3.3	3.3	4.8	4.8
304.8	12	419.1	16.5	269.875	10.625	269.875	10.625	1.5	1.5	6.4	6.4
304.902	12.004	412.648	16.246	266.7	10.5	266.7	10.5	3.3	3.3	3.3	3.3
317.5	12.5	422.275	16.625	269.875	10.625	269.875	10.625	4.32	1.57	3.3	3.3
		422.275	16.625	269.875	10.625	269.875	10.625	3.8	1.5	5.5	3.3
330.2	13	444.5	17.5	301.625	11.875	301.625	11.875	3.3	3.3	3.3	3.3
333.375	13.125	469.9	18.5	342.9	13.5	342.9	13.5	8	2	5	4
340.8	13.4173	419.1	16.5	268.875	10.5856	268.875	10.5856	1.5	1.5	6.4	6.4
341.312	13.4375	457.098	17.996	254	10	254	10	2	1.5	3.3	3.3
		457.098	17.996	254	10	254	10	2	1.5	3.3	3.3

Basic load ratings		Designations	Weight Graph	
C _r	C _{or}		kg	
kN				
2040	6200	EE135111DW/135155-135156DW-3/C9	103	1
2880	6200	EE135111DW/135155-135156DW/HEC9	103	1
2040	6200	EE135111DW/135155-135156DW/W281	103	1
2880	6200	KEE135111DW/K135155-K135156D	103	1
2000	5900	LM654648DGW/LM654610-LM654610D-3/C9	74.4	1
2640	8150	M255449DGW/M255410-M255410D	125	1
2640	8150	M255449DGW/M255410-M255410D/HE	125	1
3500	8400	M255449DGW/M255410-M255410D/W283	125	1
3400	8150	M255449D/M255410-M255410D	125	1
3400	8150	M255449DW/M255410-M255410D	125	1
2640	8150	M255449DW/M255410-M255410D/HE	125	1
3700	9400	HM256849D/HM256810-HM256810D	142	1
3400	8300	HM256849D/HM256810-HM256810D/W283	135	1
2700	7450	M757448D/M757410-M757410D-3	134	1
2700	7450	M757448DWX2A6/M757410A6-M757410D-3/C9YA11	134	1
2570	7500	M257149DW/M257110-M257110D	112	1
2420	6960	KM257248DW/KM257210-KM257210D	102	1
2880	7280	LM258648DGW/LM258610/HEC9DB	103	1
2880	7280	LM258648DWA6/LM258610A6-LM258610D/C9	103	1
3600	8800	M260149DGW/M260110-M260110D/C9	129	1
3400	10300	HM261049DWAYD/HM261010A6-HM261010D/C9	188	1
2570	7500	M257149DGW/M257110-M257110D	112	1
2740	7050	LM761648D/LM761610-LM761610D	112	1
2740	7050	LM761648D/LM761610-LM761610D-3	112	1

Four-row Tapered Roller Bearing(Inch)

d 342.9~456.794 mm

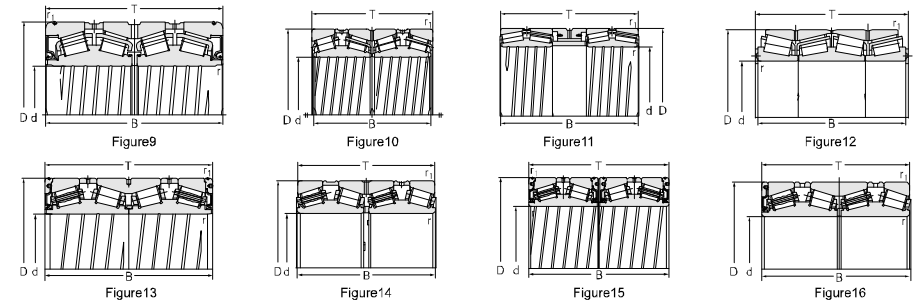
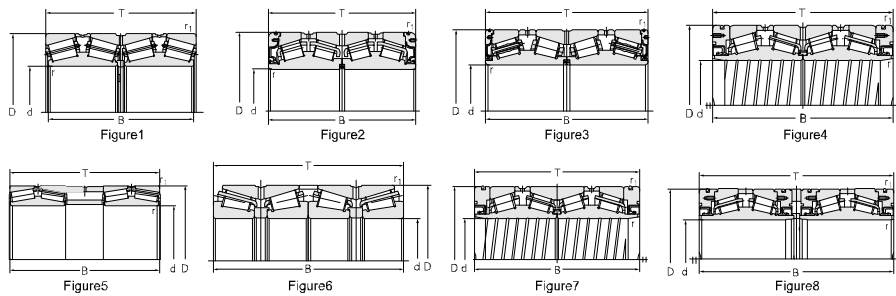

Principal dimensions								Chamfer dimensions			
d	D	T		B		r _{min} radial	r _{min} axial	r _{1min} radial	r _{1min} axial		
mm	in	mm	in	mm	in	mm	mm	mm	mm		
342.9	13.5	533.4	21	307.975	12.125	307.975	12.125	3.3	3.3	3.3	3.3
		533.4	21	301.625	11.875	307.975	12.125	3.3	3.3	3.3	3.3
		533.4	21	301.625	11.875	307.975	12.125	3.3	3.3	3.3	3.3
343.052	13.506	457.098	17.996	254	10	254	10	1.5	1.5	3.3	3.3
347.662	13.6875	469.9	18.5	292.1	11.5	292.1	11.5	3.3	3.3	3.3	3.3
355.6	14	457.2	18	252.412	9.9375	252.412	9.9375	1.5	1.5	3.3	3.3
		488.95	19.25	317.5	12.5	317.5	12.5	1.5	1.5	3.3	3.3
		488.95	19.25	317.5	12.5	317.5	12.5	1.5	1.5	3.3	3.3
355.6		488.95	19.25	317.5	12.5	317.5	12.5	1.5	1.5	3.3	3.3
		488.95	19.25	317.5	12.5	317.5	12.5	1.5	1.5	3.3	3.3
		488.95	19.25	317.5	12.5	317.5	12.5	1.5	1.5	3.3	3.3
		488.95	19.25	317.5	12.5	317.5	12.5	1.5	1.5	3.3	3.3
368.3	14.5	523.875	20.625	382.588	15.0625	382.588	15.0625	3.3	3.3	6.4	6.4
384.175	15.125	546.1	21.5	400.05	15.75	400.05	15.75	3.3	3.3	6.4	6.4
409.575	16.125	546.1	21.5	334.962	13.1875	334.962	13.1875	1.5	1.5	6.4	6.4
		546.1	21.5	334.962	13.1875	334.962	13.1875	1.5	1.5	6.4	6.4
		546.1	21.5	334.962	13.1875	334.962	13.1875	1.5	1.5	6.4	6.4
		546.1	21.5	334.962	13.1875	334.962	13.1875	1.5	1.5	6.4	6.4
		546.1	21.5	334.962	13.1875	334.962	13.1875	1.5	1.5	6.4	6.4
415.925	16.375	590.55	23.25	434.975	17.125	434.975	17.125	3.3	3.3	6.4	6.4
		590.55	23.25	434.975	17.125	434.975	17.125	3.3	3.3	6.4	6.4
447.675	17.625	635	25	463.55	18.25	463.55	18.25	3.3	3.3	6.4	6.4
		635	25	463.55	18.25	463.55	18.25	3.3	3.3	6.4	6.4
449.949	17.7145	594.949	23.4232	368	14.4882	368	14.4882	4	4	8	8
456.794	17.984	761.873	29.995	527.05	20.75	527.05	20.75	3.3	3.3	6.4	6.4

Basic load ratings		Designations	Weight Graph	
C _r	C _{or}		kg	
kN				
4300	9000	EE971355DW/972100-972103D	246	1
3660	8460	KEE971355DW/K972100-K972103D	246	1
3660	8460	KEE971355DW/K972100-K972103D/HG2	246	1
2800	6900	LM761649DWSH/LM761610SH-LM761610DSH-3	111	1
2600	7950	M262449D/M262410-M262410D	142	1
2080	6850	LM263149D/LM263110-LM263110D	97.4	1
3150	10000	KM263349D/KM263310-KM263310D	177	1
3550	10000	M263349DGW/M263310-M263310D/C9	177	1
3150	10000	M263349D/M263310-M263310D	177	1
4750	11000	M263349D/M263310-M263310D-XRS	165	2
4750	11000	M263349D/M263310-M263310D-XRS/HCEC9	165	2
3150	10000	M263349DW/M263310-M263310D-3	177	1
6200	14800	HM265049DW/HM265010-HM265010D	274	1
6120	16400	HM266449DW/HM266410-HM266410CD	310	1
3470	11500	M667947ADW/M667910-M667910D/C9	213	1
4400	11500	M667947DGW/M667911-M667911D/ZP-1	213	1
4400	11500	M667947DGW/M667911-M667911D/ZPC91	213	1
3470	11500	M667947D/M667910-M667910D	213	1
4150	10400	M667947DW/M667910-M667910D-XRS/HEC9YB2	205	2
5400	16500	M268749D/M268710-M268710D	369	1
5700	17700	M268749DWH/M268710-M268710D	375	14
8150	21000	M270749ADW/M270710-M270710D-3	485	1
8150	21000	M270749DGW/M270710-M270710D	485	1
4900	15700	M270448DGW/M270410/DB-3	300	1
10600	22900	EE425176D/425299-425299D-3	973	1

Four-row Tapered Roller Bearing(Inch)

d 457.2~603.25 mm

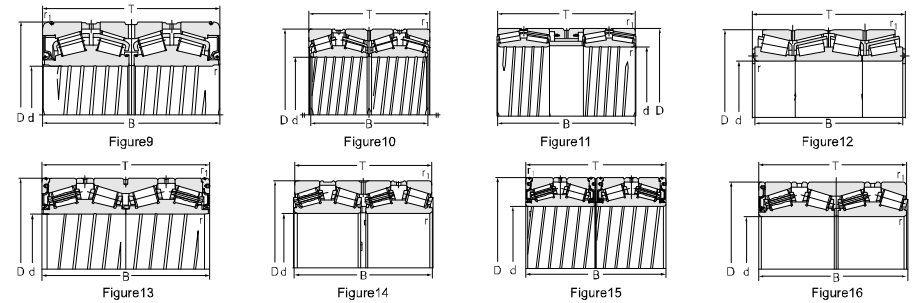
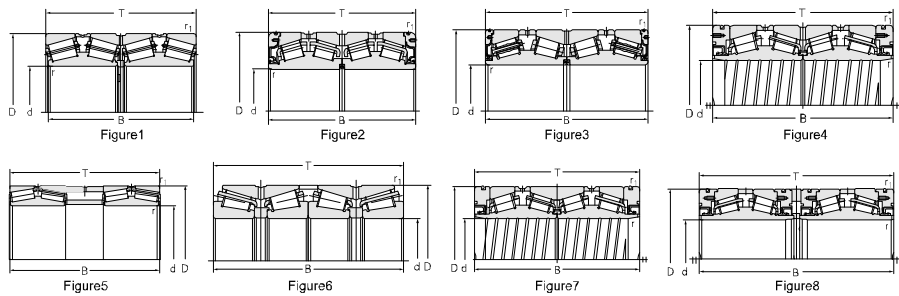

Principal dimensions								Chamfer dimensions			
d		D		T		B		r _{1min} radial	r _{1min} axial	r _{1min} radial	r _{1min} axial
mm	in	mm	in	mm	in	mm	in	mm			
457.2	18	596.9	23.5	279.4	11	276.225	10.875	3.8	1.5	5.5	3.3
460*		625		421		421		3	3	9	9
		625*		421		421		1.5	1.5	6.4	6.4
482.6	19	615.95	24.25	330.2	13	158.75	6.25	3.3	3.3	6.4	6.4
		615.95	24.25	330.2	13	330.2	13	3.3	3.3	6.4	6.4
		635	25	421	16.5748	421	16.575	3	3	6.4	6.4
		647.7	25.5	417.512	16.437	417.512	16.437	3.3	3.3	6.4	6.4
489.026	19.253	634.873	24.995	320.675	12.625	320.675	12.625	7.5	3.3	3.3	3.3
501.65	19.75	711.2	28	520.7	20.5	520.7	20.5	3.3	3.3	6.4	6.4
		711.2	28	520.7	20.5	520.7	20.5	3.3	3.3	6.4	6.4
508	20	695.325	27.375	415.925	16.375	415.925	16.375	3.3	3.3	6.4	6.4
514.35	20.25	673.1	26.5	422.275	16.625	422.275	16.625	3.3	3.3	6.4	6.4
519.112	20.437	736.6	29	536.575	21.125	536.575	21.125	3.3	3.3	6.4	6.4
		736.6	29	536.575	21.125	536.575	21.125	3.3	3.3	6.4	6.4
558.8	22	736.6	29	409.575	16.125	409.575	16.125	3.3	3.3	6.4	6.4
		736.6	29	409.575	16.125	409.575	16.125	3.3	3.3	6.4	6.4
		736.6	29	409.575	16.125	409.575	16.125	3.3	3.3	6.4	6.4
		736.6	29	409.575	16.125	409.575	16.125	3.3	3.3	6.4	6.4
571.5	22.5	812.8	32	593.725	23.375	593.725	23.375	3.3	3.3	6.4	6.4
585.788	23.063	771.525	30.375	479.425	18.875	479.425	18.875	3.3	3.3	6.4	6.4
		771.525	30.375	479.425	18.875	479.425	18.875	3.3	3.3	6.4	6.4
		771.525	30.375	479.425	18.875	479.425	18.875	3.3	3.3	6.4	6.4
603.25	23.75	857.25	33.75	622.3	24.5	622.3	24.5	3.3	3.3	6.4	6.4
		857.25	33.75	622.3	24.5	622.3	24.5	8.7	12.7	8.3	6.5
		857.25	33.75	622.3	24.5	622.3	24.5	8.7	12.7	8.3	6.5

Basic load ratings		Designations	Weight Graph	
C _r	C _{or}			
kN			kg	
4000	10300	L770847DGWA6/L770810A6-L770810D-3/C9	198	10
8050	18400	M271149D/M271110-M271110D	375	10
		M271149DW/M271110-M271110D-XRS/C9YB2	366	2
6450	16900			
4100	15200	LM272249D/LM272210-LM272210D-2/C9	252	1
4800	13700	LM272249DW/LM272210-LM272210D-XRS	237	2
6790	19000	M272449DW/M272410-M272410D/C9	354	1
7000	18700	M272647D/M272610-M272610D-3/C9	383	1
3850	12600	LM772749DGWA6/LM772710-LM772710D-3/C9	258	10
9690	26900	M274149DW/M274110-M274110D	687	14
9650	26900	M274149DW/M274110-M274110D-3/C9	671	14
5800	19600	LM274049DW/LM274010-LM274010D	464	1
7000	21000	LM274449DW/LM274410-LM274410D	408	1
8740	25900	M275349DGW/M275310-M275310D	720	10
8740	25900	M275349DGW/M275310-M275310D-3	720	10
6430	20500	LM377449D/LM377410-LM377410D	460	1
6430	20500	LM377449D/LM377410-LM377410D/HE	460	1
6430	20500	LM377449D/LM377410-LM377410D/HE-2	460	1
6430	20500	LM377449D/LM377410-LM377410D/HEC9	460	1
11500	36500	M278749DW/M278710-M278710D/YB2-2	1073	1
8100	26700	LM278849DGW/LM278810-LM278810D	595	10
8100	26700	LM278849DGWX2/LM278810-LM278810D-XRS	676	2
9000	24200	LM278849D/LM278810-LM278810D-XRS	600	2
14000	38900	M280249DGWA/M280210/DBYB2	1167	14
14000	38900	M280249DWA6/M280210A6-M280210D	1168	14
14000	38900	M280249DWA6/M280210A6-M280210D/C9	1172	14

Four-row Tapered Roller Bearing(Inch)

d 609.6~963.6 mm

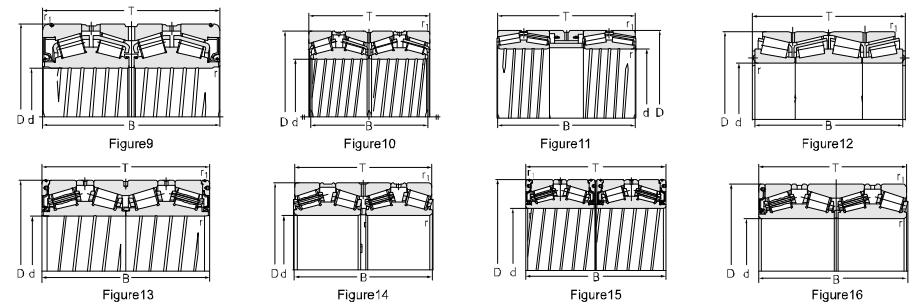
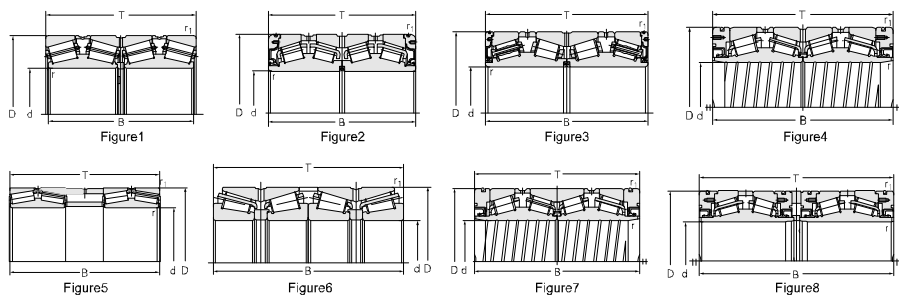

Principal dimensions								Chamfer dimensions			
d		D		T		B		r _{1min} radial	r _{1min} axial	r _{1min} radial	r _{1min} axial
mm	in	mm	in	mm	in	mm	in	mm		mm	
609.6	24	787.4	31	361.95	14.25	361.95	14.25	3.3	3.3	6.4	6.4
		787.4	31	361.95	14.25	361.95	14.25	3.3	3.3	6.4	6.4
646.112	25.4375	857.25	33.75	542.925	21.375	542.925	21.375	3.3	3.3	6.4	6.4
		857.25	33.75	542.925	21.375	542.925	21.375	3.3	3.3	6.4	6.4
660.4	26	812.8	32	356.125	14.375	356.125	14.375	3.3	3.3	6.4	6.4
682.625	26.875	965.2	38	701.675	27.625	701.675	27.625	3.3	3.3	6.4	6.4
717.55	28.25	946.15	37.25	565.15	22.25	565.15	22.25	3.3	3.3	6.4	6.4
		946.15	37.25	565.15	22.25	565.15	22.25	3.3	3.3	6.4	6.4
		946.15	37.25	565.15	22.25	565.15	22.25	3.3	3.3	6.4	6.4
762	30	1079.5	42.5	787.4	31	787.4	31	4.8	4.8	12.7	12.7
		1079.5	42.5	787.4	31	787.4	31	4.8	4.8	12.7	12.7
803.803	31.646	1130.3	44.5	717.551	28.25	717.551	28.25	3.3	3.3	9.7	9.7
863.6	34	1130.3	44.5	717.551	28.25	717.551	28.25	3.3	3.3	9.7	9.7
		1130.3	44.5	669.925	26.375	669.925	26.375	11	4.8	12.7	12.7

Basic load ratings		Designations	Weight Graph	
C _r	C _{or}		kg	
kN				
7100	22000	EE649241D/649310-649311D	460	10
7100	22000	EE649241DGW/649310-649311D/C9YAD	454	14
11300	33500	LM281049DW/LM281010-LM281010D	859	10
11300	33500	LM281049DW/LM281010-LM281010D/HEC9W281	859	10
5300	19800	L281149DW/L281110-L281110D	403	10
17400	50000	M282249D/M282210-M282210D	1714	14
14100	40800	LM282847DGW/LM282810-LM282810D-2-JG	1095	14
14100	40800	LM282847DGW/LM282810-LM282810D-EG	1095	14
13300	41000	LM282847D/LM282810-LM282810D	1085	14
20500	61900	M284249DGW/M284210-M284210D/CNH	2340	14
21800	65000	M284249DW/M284210-M284210D	2490	14
19500	62000	LM286230T-46TD-49T/10/C9YA6-3	2160	12(****)
19500	62000	LM286230T-46TD-49T/10/C9YA6	2160	12(****)
19500	62000	LM286249DGW/LM286210-LM286210D/C9	1885	14

Thrust Ball Bearing

Product Characteristics

Thrust ball bearing consists of shaft washer, housing washer, steel balls and cage. The ring matched with shaft is called shaft washer, the ring matched with housing is called housing washer. If the housing washer's installation surface is spherical, then the bearing can be aligned by itself and reduce influence of installation deviation.

Thrust ball bearing is mainly used to bear axial loads, and can transfer big axial loads. It can not bear radial loads.

This type of bearing can be applied to steering system of automobile and main shaft of machinery.

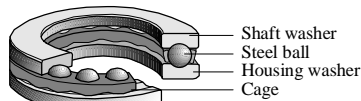

(Thrust ball bearing)

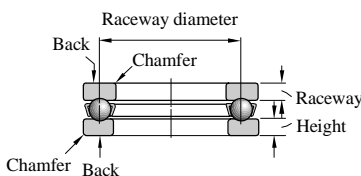
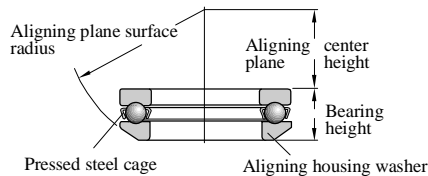
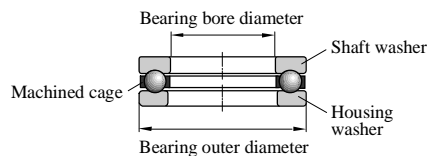

Product types

ZWZ thrust ball bearings can be classified into 2 types:

- Single-direction thrust ball bearing
- Double-direction thrust ball bearing

Single- direction thrust ball bearing:

Consist of one shaft washer, one housing washer and steel balls - cage units. Bearing can be separated. Shaft washer, housing washers, steel ball - cage units can be installed individually. These bearings cover 3 types:

- Thrust ball bearing with flat housing washer
- Thrust ball bearing with self-aligning housing washer
- Thrust ball bearing with self-aligning housing washer and self-aligning housing washer

Single-direction thrust ball bearings are mainly used to bear axial loads from one direction and make axial location in one direction.

Double-direction thrust ball bearing

Consist of one shaft washer, two housing washers and steel balls - cage units. Bearing can be separated. Shaft washer, housing washer, steel ball-cage units can be installed individually. These bearings cover 3 types:

- Thrust ball bearing with flat housing washer
- Thrust ball bearing with self-aligning housing washer
- Thrust ball bearing with self-aligning housing washer and self-aligning housing washer

Double-direction thrust ball bearings are mainly used to bear axial loads from two directions and make axial location for two directions.

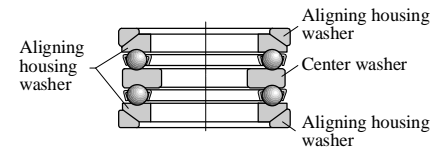

Dimension range

Thrust ball bearings produced by ZWZ are listed in the table,
 Bore diameter range: 25mm~1380mm
 Outer diameter range: 42mm~1540 mm
 Width range: 11mm~160mm

Tolerance

ZWZ standard thrust ball bearing precisions cover P0, P6, P5, and P4 and conform to state standards. Please refer to tolerance table in preface.

Cage

Normally pressed cage and solid cage are adopted for this type of bearings. Other cages can be used for this type of bearing for special applications.

If bearing max O.D. is 250 mm, the pressed sheet-steel cage will be adopted that are not indicated in the suffix of bearing specifications. If bearing minimum OD is 250 mm, then the solid brass cage will be used. And the cage type will not be indicated in the suffix of bearing specifications. Others will be relatively indicated their suffix.

Minimum axial loads

During the thrust ball is in operation, if the external loads are too small and the axial direction is not pressed tightly, then due to the function of eccentric force, the steel balls will

be caused to slide as well as to effect the bearing normal operation. In order to avoid this, minimum axial loads F_{amin} must be applied to the thrust ball bearing.

$$F_{amin} = 5.1 \left(\frac{n \cdot C_{0a}}{1000} \right) \times 10^{-6}$$

F_{amin} : minimum loads needed [KN]
 n: Rotation speed r/min
 Coa: basic rating loads [KN]

Permissible angle deviation

The two supporting surface of the thrust ball bearing must be parallel, any of the deviation is not allowed. The spherical housing washer and the spherical washer possess aligning property, which can reduce the effect of the angle deviation while mounting.

Equivalent Dynamic Load

$$P = F_a \quad [KN]$$

Equivalent Static Load

$$P_0 = F_a \quad [KN]$$

Thrust Ball Bearing

d 25-55 mm

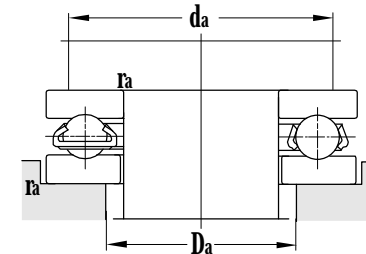
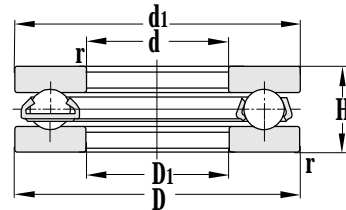
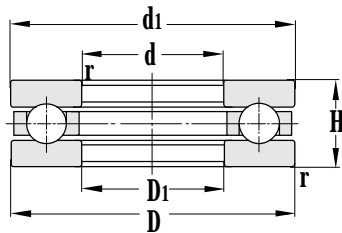

Principal dimensions				Basic load ratings		Limit speed ratings		Designations
d	D	H	r _{min}	C _r	C _{or}	Grease	Oil	
mm				kN		r/min		
25	42	11	0.6	18.7	38.0	4800	6300	51105
	47	15	0.6	27.0	54.0	4000	5300	51205
	52	18	1	35.0	59.0	3400	4500	51305
30	47	11	0.6	19.6	42.0	4500	6000	51106
	52	16	0.6	27.3	50.0	3600	4800	51206
	60	21	1	42.5	70.0	2800	3800	51306
	70	28	1	71.0	134	2000	3000	51406
35	52	12	0.6	20.8	50.0	4300	5600	51107
	52	12	0.6	20.8	50.0	4300	5600	51107H
	52	12	0.6	20.8	50.0	4300	5600	51107M
	55	16	0.6	24.9	53.5	4300	5600	51107X3
	62	18	1	37.0	72.0	3000	4000	51207
	68	24	1	55.5	94.5	2400	3400	51307
	68	24	1	55.5	94.5	2400	3400	51307/YA6
	68	24	1	55.5	94.5	2400	3400	51307/YA6
40	60	13	0.6	27.3	62.0	3800	5000	51108
	60	13	0.6	27.3	62.0	3800	5000	51108H
	68	19	1	47.0	104	2800	3800	51208
	68	19	1	47.0	104	2800	3800	51208M
	78	26	1	68.5	120	2000	3000	51308
	100	28	1.1	75.0	189	1700	2400	51708
45	65	14	0.6	26.7	68.0	3400	4500	51109
	65	14	0.6	26.7	68.0	3400	4500	51109M
	73	20	1	38.0	85.0	2600	3600	51209
	85	28	1	74.5	150	1900	2800	51309
50	70	14	0.6	27.3	73.5	3200	4300	51110
	70	14	0.6	27.3	73.5	3200	4300	51110M
	78	22	1	54.5	114	2400	3400	51210
	95	31	1.1	96.0	186	1800	2600	51310
	110	43	1.5	159	335	1600	2500	51410M
55	78	16	0.6	33.5	83.0	2800	3800	51111

Other dimensions		Abutment and fillet dimensions			Weight
d1	D1	d _{amin}	D _{amax}	r _{amax}	
mm		mm			kg
42	26	35	32	0.6	0.0589
47	27	38	34	0.6	0.117
52	27	41	36	1	0.165
47	32	40	37	0.6	0.0642
52	32	43	39	0.6	0.138
60	32	48	42	1	0.266
70	32	54	46	1	3.94
52	37	45	42	0.6	0.0779
52	37	45	42	0.6	0.0779
52	37	45	42	0.6	0.0817
55	37	50	45	0.6	0.141
62	37	51	46	1	0.193
68	37	55	48	1	0.361
68	37	55	48	1	0.301
60	42	52	48	0.6	0.118
60	42	52	48	0.6	0.126
68	42	57	51	1	0.273
68	42	57	51	1	0.324
78	42	63	55	1	0.521
100	58	75	65	1	0.970
65	47	57	53	0.6	0.139
65	47	57	53	0.6	0.162
73	47	62	56	1	0.332
85	47	69	61	1	0.656
70	52	62	58	0.6	0.155
70	52	62	58	0.6	0.186
78	52	67	61	1	0.374
95	52	77	68	1	0.942
110	52	86	74	1.5	1.86
78	57	69	64	0.6	0.226

Thrust Ball Bearing

d 55-80 mm

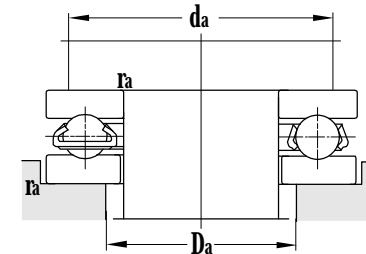
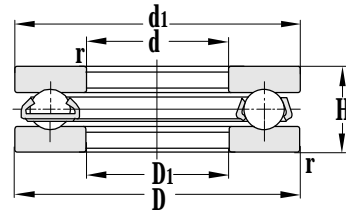
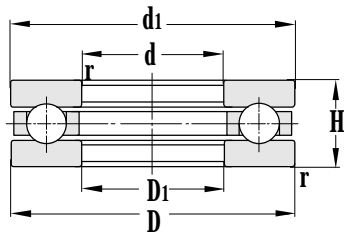

Principal dimensions				Basic load ratings		Limit speed ratings		Designations
d	D	H	r _{min}	C _r	C _{or}	Grease	Oil	
mm				kN		r/min		
55	78	16	0.6	33.5	83.0	2800	3800	51111M
	90	25	1	69.0	143	2200	3200	51211
	105	35	1.1	119	220	1700	2400	51311
	120	48	1.5	191	380	1500	2100	51411M
60	85	17	1	41.0	120	2600	3600	51112
	85	17	1	41.0	120	2600	3600	51112M
	95	26	1	74.0	147	1900	2800	51212
	95	26	1	74.0	147	1900	2800	51212M
	110	35	1.1	100	220	1600	2200	51312
	130	51	1.5	200	420	1400	1900	51412M
65	90	18	1	45.5	106	2500	3500	51113
	90	18	1	45.5	106	2500	3500	51113M
	100	27	1	75.5	160	1850	2700	51213
	115	36	1.1	107	235	1500	2000	51313
	140	56	2	239	480	1300	1800	51413M
	140	56	2	240	505	1300	1800	51413J
70	95	18	1	49.5	119	2400	3400	51114
	95	18	1	49.5	119	2400	3400	51114M
	95	18	1	47.5	134	2400	3400	51114/YA8
	105	27	1	77.0	170	1800	2600	51214
	105	27	1	77.0	170	1800	2600	51214/YA8
	125	40	1.1	148	315	1400	1900	51314
	125	40	1.1	148	315	1400	1900	51314M
	150	60	2	257	540	1200	1600	51414M
75	100	19	1	48.0	143	2200	3200	51115
	100	19	1	48.0	143	2200	3200	51115M
	110	27	1	66.0	180	1750	2500	51215
	135	44	1.5	175	380	1300	1800	51315
	160	65	2	251	560	1100	1500	51415M
80	105	19	1	49.5	150	2000	3000	51116
	115	28	1	74.5	205	1700	2400	51216

Other dimensions		Abutment and fillet dimensions			Weight
d1	D1	damin	Damax	ramax	
mm		mm			kg
78	57	69	64	0.6	0.242
90	57	76	69	1	0.571
105	57	85	75	1	1.35
120	57	94	81	1.5	2.61
85	62	75	70	1	0.263
85	62	75	70	1	0.294
95	62	81	74	1	0.695
95	62	81	74	1	0.752
110	62	90	80	1	1.39
130	62	102	88	1.5	3.48
90	67	80	75	1	0.315
90	67	80	75	1	0.363
100	67	86	79	1	0.733
115	67	95	85	1	1.54
140	68	110	95	2	4.71
140	68	110	95	2	4.16
95	72	85	80	1	0.351
95	72	85	80	1	0.377
95	72	85	80	1	0.348
105	72	91	84	1	0.764
105	72	91	84	1	0.756
125	72	103	92	1	2.00
125	72	103	92	1	2.85
150	73	118	102	2	5.06
100	77	90	85	1	0.382
100	77	90	85	1	0.429
110	77	96	89	1	0.83
135	77	111	99	1.5	2.61
160	78	126	109	2	6.61
105	82	95	90	1	0.399
115	82	101	94	1	0.92

Thrust Ball Bearing

d 80-110 mm

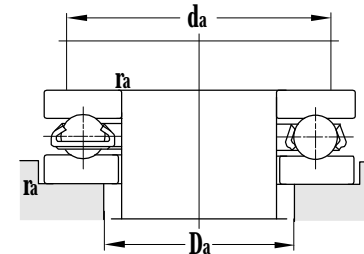
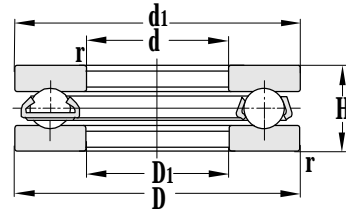
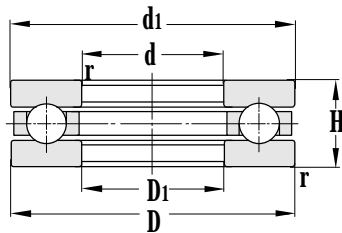

Principal dimensions				Basic load ratings		Limit speed ratings		Designations
d	D	H	r _{min}	C _r	C _{or}	Grease	Oil	
mm				kN		r/min		
80	140	44	1.5	181	425	1200	1700	51316
	140	44	1.5	173	395	1200	1700	51316M
	170	68	1.1	315	655	1000	1400	51416M
85	110	19	1	49.5	160	1900	2800	51117
	125	31	1	111	270	1600	2200	51217
	150	49	1.5	223	475	1100	1600	51317
	150	49	1.5	223	475	1100	1600	51317M
	180	72	1.1	335	735	950	1200	51417M
	180	72	1.1	335	735	950	1200	51417
90	120	22	1	65.0	205	1800	2600	51118
	120	22	1	65.0	205	3000	4000	51118M/P4
	135	35	1.1	132	320	1500	2000	51218
	155	50	1.5	232	520	1000	1500	51318
	155	50	1.5	232	520	1000	1500	51318M
	190	77	2.1	380	800	900	1100	51418M
100	135	25	1	83.5	285	1700	2400	51120
	135	25	1	83.5	285	1700	2400	51120M
	150	38	1.1	125	350	1300	1800	51220
	150	38	1.1	125	350	1300	1800	51220M
	170	55	1.5	276	705	950	1400	51320
	170	55	1.5	276	705	950	1400	51320M
	172	57	1.8	276	705	900	1300	51720
	210	85	3	420	1130	850	1000	51420
	210	85	3	420	1040	850	1000	51420M
	100.2	150	38	1.1	163	430	1600	1800
110	145	25	1	85.5	310	1650	2300	51122
	145	25	1	85.5	310	1650	2300	51122M
	160	38	1.1	131	395	1200	1700	51222
	160	38	1.1	131	395	1200	1700	51222M
	190	63	2	305	800	850	1200	51322M
	190	63	2	305	800	850	1200	51322

Other dimensions		Abutment and fillet dimensions			Weight
d1	D1	d _{amin}	D _{amax}	r _{amax}	
mm		mm			kg
140	82	116	104	1.5	2.63
140	82	116	104	1.5	2.92
170	83	133	117	2	7.89
110	87	100	95	1	0.419
125	88	109	101	1	1.21
150	88	124	111	1.5	3.49
150	88	124	111	1.5	3.97
177	88	141	124	2	8.60
177	88	141	124	2	8.35
120	92	108	102	1	0.632
120	92	108	102	1	0.721
135	93	117	108	1	1.67
155	93	129	116	1.5	4.02
155	93	129	116	1.5	4.44
187	93	149	131	2	9.91
135	102	121	114	1	0.937
135	102	121	114	1	0.937
150	103	130	120	1	2.12
150	103	130	120	1	2.33
170	103	142	128	1.5	4.85
170	103	142	128	1.5	5.42
172	100.2	143	129	1.8	5.36
205	103	165	145	2.5	13.6
205	103	165	145	2.5	13.5
150	100.2	130	120	1	2.20
145	112	131	124	1	1.12
145	112	131	124	1	1.21
160	113	140	130	1	2.43
160	113	140	130	1	2.67
187	113	158	142	2	7.36
187	113	158	142	2	7.08

Thrust Ball Bearing

d 110~150 mm

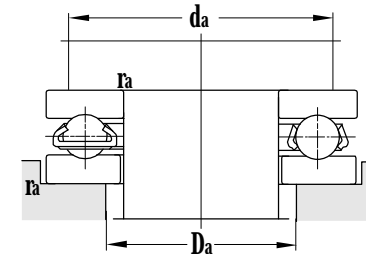
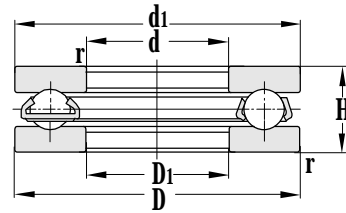
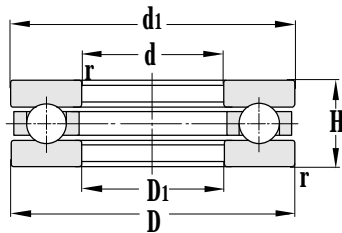

Principal dimensions				Basic load ratings		Limit speed ratings		Designations
d	D	H	r _{min}	C _r	C _{or}	Grease	Oil	
mm				kN		r/min		
110	230	95	3	490	1200	750	900	51422M
120	155	25	1	86.5	330	1600	2200	51124
	155	25	1	86.5	330	1600	2200	51124M
	170	39	1.1	167	430	1100	1600	51224
	170	39	1.1	167	430	1100	1600	51224M
	210	70	2.1	350	960	800	1100	51324M
	210	70	2.1	350	960	800	1100	51324
	250	102	4	535	1670	600	800	51424M
130	170	27	3	111	415	1500	2000	51726M
	170	30	1	111	415	1400	1900	51126M
	170	30	1	111	415	1400	1900	51126
	190	45	1.5	230	575	1000	1500	51226
	190	45	1.5	230	575	1000	1500	51226M
	225	75	2.1	395	1120	750	1000	51326M
	225	75	2.1	395	1120	750	1000	51326
	270	110	4	635	1670	560	750	51426J
	270	110	4	635	1670	560	750	51426
	140	180	31	1	114	430	1300	1800
180		31	1	114	430	1300	1800	51128M
200		46	1.5	234	610	950	1400	51228
200		46	1.5	234	610	950	1400	51228M
240		80	2.1	415	1300	700	950	51328
280		112	4	630	1700	530	700	51428
150		190	31	1	117	430	1200	1700
	190	31	1	117	430	1200	1700	51130
	200	35	2.1	164	535	1100	1600	51730M
	215	50	1.5	262	785	900	1300	51230M
	215	50	1.5	262	785	900	1300	51230
	250	80	2.1	430	1370	670	900	51330M
	250	80	2.1	430	1370	670	900	51330
	300	120	4	675	2240	500	670	51430

Other dimensions		Abutment and fillet dimensions			Weight
d1	D1	d _{amin}	D _{amax}	r _{amax}	
mm		mm			kg
225	113	181	159	2.5	18.6
155	122	141	134	1	1.13
155	122	141	134	1	1.25
170	123	150	140	1	2.71
170	123	150	140	1	2.58
205	123	173	157	2	9.85
205	123	173	157	2	9.43
245	123	197	173	3	23.9
170	130.2	154	146	1	1.65
170	170	154	146	1	1.86
170	170	154	146	1	1.67
187	133	166	154	1.5	4.17
187	133	166	154	1.5	4.64
220	134	186	169	2	12.5
220	134	186	169	2	11.6
265	134	213	187	3	28.8
265	134	213	187	3	29.0
178	142	164	156	1	1.80
178	142	164	156	1	2.00
197	143	176	164	1.5	4.49
197	143	176	164	1.5	4.33
235	144	199	181	2	14.6
275	144	223	197	3	31.6
188	152	174	166	1	2.19
188	152	174	166	1	1.96
200	150.3	187	168	2	3.15
212	153	189	176	1.5	5.80
212	153	189	176	1.5	5.61
245	154	209	191	2	17.0
245	154	209	191	2	17.0
295	154	239	211	3	38.7

Thrust Ball Bearing

d 160~220 mm

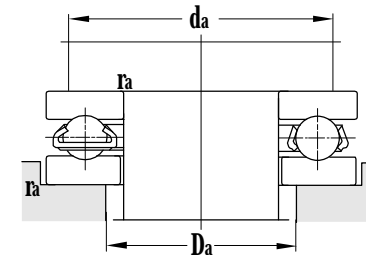
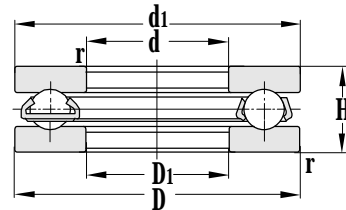
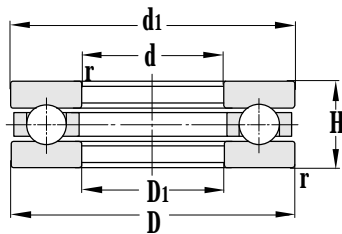

Principal dimensions				Basic load ratings		Limit speed ratings		Designations
d	D	H	r _{min}	C _r	C _{or}	Grease	Oil	
mm				kN		r/min		
160	200	31	1	121	455	1150	1650	51132M
	225	51	1.5	266	835	850	1200	51232M
	225	51	1.5	266	835	850	1200	51232
	270	87	3	455	1630	630	850	51332M
170	215	34	1.1	131	530	1100	1600	51134M
	215	34	1.1	110	430	1100	1600	51134M-1
	215	34	1.1	131	530	1100	1600	51134
	240	55	1.5	281	1000	830	1100	51234M
	240	55	1.5	281	1000	830	1100	51234
	280	87	3	470	1730	600	800	51334
180	225	34	1.1	151	560	1000	1500	51136M
	225	34	1.1	151	560	1000	1500	51136
	250	56	1.5	295	1060	800	1050	51236M
	250	56	1.5	295	1060	800	1050	51236
	300	95	3	515	1960	560	750	51336
190	240	37	1.1	178	670	950	1400	51138M
	240	37	1.1	178	670	950	1400	51138
	270	62	2	355	1250	780	1000	51238J
	270	62	2	355	1250	780	1000	51238
	320	105	4	607	2350	500	700	51338
190.5	266.7	57.1	4	276	695	710	1030	517/190.5
200	250	37	1.1	183	695	930	1350	51140M
	280	62	2	350	1290	750	980	51240J
	280	62	2	350	1290	750	980	51240
	340	110	4	660	2550	480	630	51340
220	270	37	1.1	186	785	900	1300	51144
	300	63	2	365	1430	700	950	51244
	300	63	2	365	1430	700	950	51244J
	300	93.75	2	400	1550	650	900	51244X2V

Other dimensions		Abutment and fillet dimensions			Weight
d1	D1	d _{amin}	D _{amax}	r _{amax}	
mm		mm			kg
198	162	184	176	1	2.38
222	163	199	186	1.5	6.19
222	163	199	186	1.5	6.08
265	164	225	205	2.5	18.8
213	172	197	188	1	2.99
213	172	197	188	1	2.94
213	172	197	188	1	2.64
237	173	212	198	1.5	7.65
237	173	212	198	1.5	7.33
275	174	235	215	2.5	19.9
222	183	207	198	1	3.08
222	183	207	198	1	2.86
247	183	222	208	1.5	8.15
247	183	222	208	1.5	8.02
295	184	251	229	2.5	26.7
237	193	220	210	1	4.02
237	193	220	210	1	3.62
267	194	238	222	2	11.0
267	194	238	222	2	11.7
315	195	266	244	3	33.5
190.5	266.7	242.6	214.6	4	14.3
247	203	230	220	1	3.60
277	204	248	232	2	10.9
277	204	248	232	2	11.5
335	205	282	258	3	30.8
267	223	250	240	1	4.45
297	224	268	252	2	12.9
297	224	268	252	2	12.2
300	220.5	268	252	2	19.8

Thrust Ball Bearing

d 230~380 mm

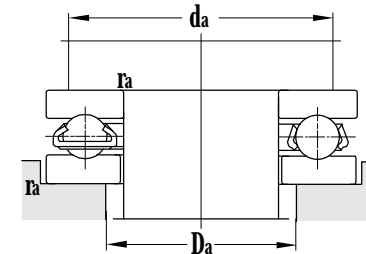
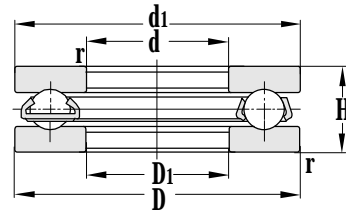
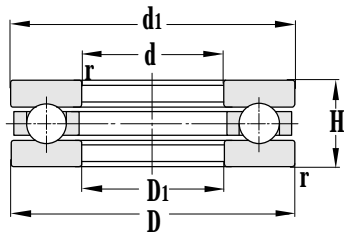

Principal dimensions				Basic load ratings		Limit speed ratings		Designations
d	D	H	r _{min}	C _r	C _{or}	Grease	Oil	
mm				kN		r/min		
230	300	53.4	2.1	264	955	650	900	51746
240	300	45	1.5	259	1020	850	1200	51148
	340	78	2.1	455	1960	630	860	51248
	340	70	2.5	415	1650	600	800	51748
	340	70	2.5	415	1650	600	800	51748J
	380	112	4	695	2870	430	600	51348
260	320	45	1.5	264	1080	800	1100	51152
	360	79	2.1	475	2120	600	800	51252
	360	79	2.1	475	2120	600	800	51252J
280	350	53	1.5	335	1430	640	900	51156
	380	80	2.1	495	2270	560	750	51256
300	380	62	2	415	1730	630	850	51160
	420	95	3	595	2940	530	710	51260
	435	104	3.7	740	3410	450	600	51760
	432	104.8	3.7	460	2240	450	600	51760V
320	400	63	2	425	1990	610	800	51164
	440	95	3	560	2940	500	700	51264
	399.5	63	2	425	1990	600	800	51164X1
340	420	64	2	420	1920	600	830	51168
	460	96	3	605	3130	450	600	51268
	460	96	3	605	3130	450	600	51268/YB5
	540	160	5	1120	5700	400	530	51368
350	476	85	3.7	630	3150	430	550	51770
360	440	65	2	430	2040	560	750	51172
	500	110	4	795	4050	400	530	51272
380	460	65	2	420	2110	850	1000	51176/P4

Other dimensions		Abutment and fillet dimensions			Weight
d1	D1	damin	Damax	ramax	
mm		mm			kg
300	230.3	270	260	2	9.47
297	243	276	264	1.5	7.28
335	244	299	281	2	21.1
340	238	299	281	2.5	19.4
340	238	299	281	2.5	18.8
375	245	320	300	3	49.6
317	263	296	248	1.5	7.56
355	264	319	301	2	23.3
355	264	319	301	2	22.0
347	283	322	308	1.5	11.4
375	284	339	321	2	25.3
376	304	348	332	2	17.4
415	304	371	349	2.5	40.0
435	300.3	379	356	3	50.7
432	300.3	379	356	3	49.7
396	324	368	352	2	18.0
435	325	391	369	3	44.5
396	324	391	369	2	18.0
416	344	388	372	2	19.9
455	345	411	389	2.5	44.6
455	345	411	389	2.5	44.6
535	345	452	356	4	137
476	350.4	425	401	3	43.3
436	364	408	392	2	23.9
495	365	442	418	3	64.7
456	384	445	394	2	22.5

Thrust Ball Bearing

d 400~710 mm

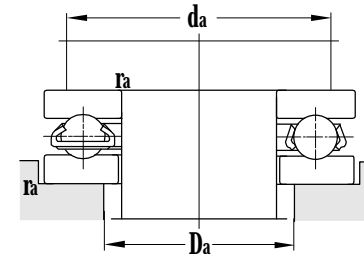
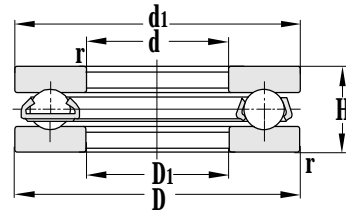
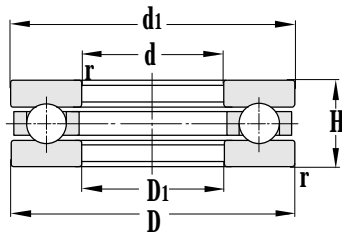

Principal dimensions				Basic load ratings		Limit speed ratings		Designations
d	D	H	r _{min}	C _r	C _{or}	Grease	Oil	
mm				kN		r/min		
400	480	65	2	435	2240	800	1000	51180/P5 51280
	540	112	4	835	4450	380	510	
420	500	65	2	440	2560	530	700	51184 51784/P4
	550	80	2.1	570	3110	500	600	
440	540	80	2.1	565	3200	500	650	51188
460	560	80	2.1	585	3200	450	600	51192 51292 51292F1
	620	130	5	895	5250	350	500	
	620	130	5	895	5250	350	500	
480	580	80	2.1	600	3500	400	500	51196
500	600	80	2.1	615	3500	430	560	511/500/P5 511/500 511/500F3 511/500/P5YB5
	600	80	2.1	615	3500	430	560	
	600	80	2.1	615	3500	430	560	
	600	80	2.1	615	3500	430	560	
530	640	85	3	690	4300	400	530	511/530 511/530/P5YB5
	640	85	3	690	4300	400	530	
560	670	85	3	650	4550	390	510	511/560
600	710	85	3	720	4700	380	500	511/600 511/600F3 511/600/P4YB5 591/600 591/600F3
	710	85	3	720	4700	380	500	
	710	85	3	720	4700	380	500	
	710	67	3	520	3450	450	600	
	710	67	3	520	3450	450	600	
630	780	112	4	905	6150	320	430	517/630
670	800	105	4	885	6550	300	400	511/670F3 511/670/P5
	800	105	4	885	6550	300	400	
710	950	185	8	1350	10010	260	300	512/710X1

Other dimensions		Abutment and fillet dimensions			Weight
d1	D1	damin	Damax	ramax	
mm		mm			kg
476	404	448	432	2	23.0
535	405	517	423	4	71.8
496	424	468	452	2	24.5
545	425	531	439	2	50.3
535	444	499	481	2	40.6
555	464	519	501	2	42.2
615	465	552	528	4	114
615	465	552	528	4	113
575	484	561	498	2	43.7
595	505	559	541	2	45.3
595	505	559	541	2	45.3
595	505	559	541	2	44.7
595	505	559	541	2	45.3
635	534	595	575	2.5	57.1
635	534	595	575	2.5	56.8
564	666	625	606	2.5	58.7
705	604	667	643	2.5	64.9
705	604	665	645	2.5	64.3
705	604	667	643	2.5	64.9
705	604	663	647	2.5	49.2
705	604	663	647	2.5	48.3
760	650	717	693	3	118
795	674	748	722	3	109
795	674	748	722	3	111
950	711	929	732	8	382

Thrust Ball Bearing

d 750~1800 mm

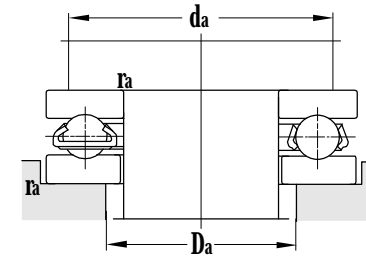
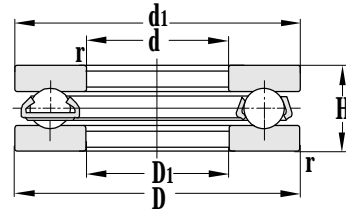
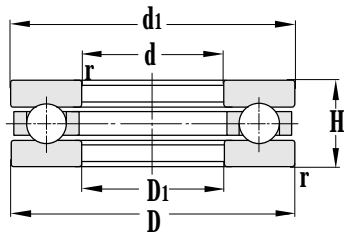

Principal dimensions				Basic load ratings		Limit speed ratings		Designations
d	D	H	r _{min}	C _r	C _{or}	Grease	Oil	
mm				kN		r/min		
750	900	90	4	815	6330	300	400	591/750
	900	120	4	980	7540	240	340	511/750/P5
780	930	100	4	905	6700	230	300	517/780F3
900	1060	95	5	835	7240	210	280	591/900
950	1110	110	5	1010	8900	200	280	591/950X3/YB2
980	1120	120	5	1080	9700	190	260	517/980/P5
1060	1250	150	5	1390	13200	180	250	511/1060
	1250	150	5	1390	13200	180	250	511/1060/P4YB5
1380	1540	130	5	1280	1410	170	240	517/1380
	1540	130	5	1280	1410	170	240	517/1380/P5YB5
1700	1960	170	7.5	1510	18800	150	220	511/1700X3/P5YB5
1720	1880	130	5	1440	17900	140	210	517/1720
1800	2000	140	5	1730	22300	120	180	517/1800/P5

Other dimensions		Abutment and fillet dimensions			Weight
d1	D1	damin	Damax	ramax	
mm		mm			kg
895	755	836	810	3	108
895	755	839	810	3	158
930	782	912	800	4	128
1054	906	1041	919	5	143
1105	955	1092	968	5	183
1115	985	1097	1006	5	183
1244	1066	1223	1087	5	343
1244	1066	1223	1087	5	343
1535	1385	1475	1445	4	319
1535	1385	1475	1445	4	319
1955	1705	1943	1717	7	824
1880	1721.2	1859	1743	5	401
1990	1810	1969	1831	5	545

Thrust Ball Bearing With Outer Cover

d 25.1~86.6 mm

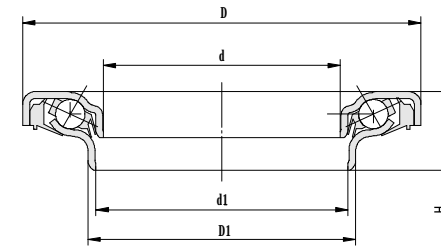
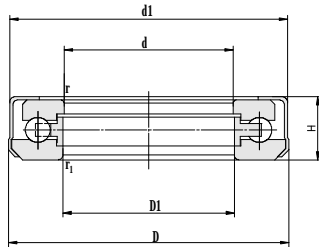

Principal dimensions					Basic load ratings		Limit speed ratings	
d	D	H	r _{min}	r _{1min}	C _r	C _{Or}	Grease	Oil
mm					kN		r/min	
25.1	49	16	0.6	0.6	16	42	4000	5300
30	53	15.8	0.6	0.6	17	38	3600	4800
32.1	60.5	18	0.6	0.6	24.5	67	3000	4200
35.1	65.9	19.7	0.6	0.6	32.7	89.4	2800	3800
50	81	23		1	59.0	105	2400	3400
52.388	84.5	20.7	1.1	1.1	21.8	46.5	2200	3200
	84.5	20.7	1.1	1.1	21.8	46.5	2200	3200
	84.5	20.7	1.1	1.1	21.8	46.5	2200	3200
54.23	90.2	20.2	1	1.5	23.2	66	1900	2800
69.84	114.3	22.1	1	1.5	42	96	1700	2500
80	145	45	1	1.5	147	335	1200	1700
86.6	137	12	1	3.5	20.7	95	850	1600

Designations	Other dimensions		Weight
	d1	D1	
mm			kg
51205ZSV		25.3	0.13
51206ZSV		30.4	0.139
517/32-2ZSV	58	32.5	0.211
51207-2ZSV	64	35.6	0.206
51710ZSV/YA		50.2	0.415
517/52X4ZS	83.5	52.8	0.366
517/52X4ZS/YA8	83.5	52.8	0.372
517/52X4ZSD	83.5	52.8	0.372
517/54X4ZSTN1	88.9	54.8	0.402
517/69X4ZSTN1	112.8	70.6	0.642
51316ZSV		82	2.83
517/86.6ZSV/RT6	86.6	137	0.145

Thrust Ball Bearing With Aligning Seat and Ring

d 30-110 mm

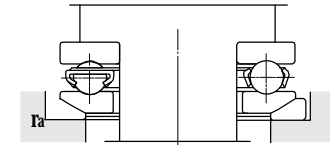
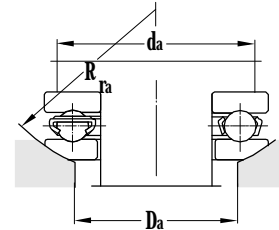
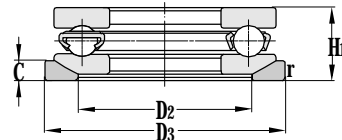
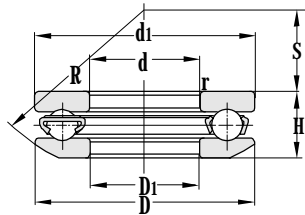

Principal dimensions			Basic load ratings		Limit speed ratings		Designations
d	D	r _{min}	C _r	C _{or}	Grease	Oil	
mm			kN		r/min		
30	52	0.6	26.6	50.0	3600	4800	53206+U206
35	62	1	37.3	72.0	3000	4000	53207+U207
40	68	1	46.9	104	2800	3800	53208+U208
45	73	1	47.6	84.8	2600	3600	53209
	73	1	47.6	84.8	2600	3600	53209+U209
50	110	1.5	160	305	2300	3200	53410M
55	90	1	69	143	1900	2800	53211+U211
60	110	1	130	287	1850	2700	53312
65	100	1	74.9	160	1800	2600	53213+U213
70	105	1	59.0	170	1750	2500	53214+U214
	130	1.1	148	314	1400	1900	53314+U314
	125	1.1	148	314			53314
75	110	1	82.1	179	1700	2400	53215+U215
80	115	1	86.6	204	1600	2200	53216+U216
	145	1.5	181	382	1200	1700	53316+U316
85	180	1.1	336	821	1300	1900	53417M
90	135	1.1	133	320	1500	2000	53218+U218
100	170	1.5	282	495	950	1400	53320+U320
	170	1.5	282	495	950	1400	53320
	205	3	445	1040	700	950	53420M+U420
	205	3	445	1040	700	950	53420+U420
110	160	1.1	170	390	1200	1700	53222+U222

Other dimensions									Abutment and fillet dimensions			Weight
d1	D1	D2	D3	C	H1	R	S	H	d _{amin}	D _{amax}	r _{amax}	
mm									mm		kg	
52	32	42	55	5.5	20	45	22	17.8	43	42	0.6	0.180
62	37	48	65	7	22	50	24	19.9	51	48	1	0.263
68	42	55	72	7	23	56	28.5	20.3	57	55	1	0.395
73	47					56	26	21.3				0.321
73	47	60	78	7.5	24	56	26	21.3	62	60	1	0.400
110	52					90	35	45.6				1.92
90	57	72	95	9	30	72	35	27.3	76	72	1	0.747
110	62					90	41	38.3				1.44
100	67	82	105	9	32	80	40	28.5	86	82	1	0.898
105	72	88	110	9	32	80	38	28.8	91	88	1	0.961
125	72	98	130	13	48	100	43	44.2	103	98	1	2.51
125	72					100	43	44.2				2.10
110	77	92	115	9.5	32	90	49	28.2	96	92	1	1.15
115	82	98	120	10	33	90	46	29.5	101	98	1	1.18
140	82	110	145	15	52	112	50	47.6	116	110	1.5	3.17
177	88					140	47	77				8.95
135	93	110	140	13.5	42	100	45	38.5	117	110	1	2.33
170	103	135	175	18	64	125	46	59.2	142	135	1.5	5.83
170	103					125	46	59.2				4.90
205	103	155	220	27	98	160	50	90	165	155	2.5	16.5
205	103	155	220	27	98	160	50	90	165	155	2.5	16.2
160	113	135	165	14	45	125	65	40.2	140	135	1	2.87

Thrust Ball Bearing With Aligning Seat and Ring

d 110~430 mm

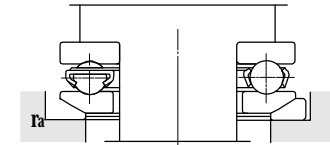
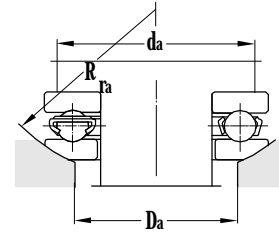
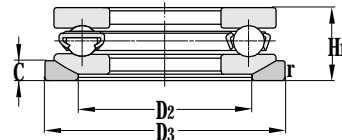
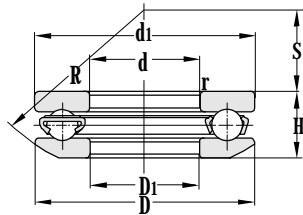

Principal dimensions			Basic load ratings		Limit speed ratings		Designations
d	D	r _{min}	C _r	C _{or}	Grease	Oil	
mm			kN		r/min		
110	190	2	305	780	850	1200	53322M+U322
	190	2	305	780	850	1200	53322+U322
120	170	1.1	168	430	1100	1600	53224+U224
	205	2.1	320	960	800	1100	53324M+U324
	205	2.1	320	960	800	1100	53324+U324
	205	2.1	320	960	800	1100	53324/YB2+U324
	205	2.1	320	960	800	1100	53324U/YB2+U324-1
130	265	4	635	2010	700	1000	53426J+U426
	265	4	635	2010	700	1000	53426+U426
150	250	2.1	430	1360	600	900	53330M+U330
	250	2.1	430	1360	600	900	53330+U330
	250	2.1	430	1360	600	900	53330/YB2+U330
	250	2.1	430	1360	600	900	53330
	295	4	675	2240	580	880	53430+U430
180	260	1.5	295	985	550	850	53236M/YB5+U237
220	297	2	365	1370	500	800	53244+U224
300	375	2.5	380	1680	400	700	51760+U760
430	580	3.7	920	5150	300	550	51786+U786

Other dimensions									Abutment and fillet dimensions			Weight
d1	D1	D2	D3	C	H1	R	S	H	d _{amin}	D _{amax}	r _{amax}	
mm									mm			kg
187	113	150	195	20.5	72	140	51	67.2	158	150	2	9.05
187	113	150	195	20.5	72	140	51	67.2	158	150	2	8.78
170	123	145	175	15	46	125	61	40.8	150	145	1	3.07
205	123	165	220	22	80	160	63	74.1	173	165	2	12.3
205	123	165	220	22	80	160	63	74.1	173	165	2	11.9
205	123	165	220	22	80	160	63	74.1	173	165	2	11.9
205	123	165	220	22	80	160	63	74.1	173	165	2	11.9
265	134	200	280	38	128	200	58	115.2	213	200	4	34.6
265	134	200	280	38	128	200	58	115.2	213	200	4	34.8
245	154	200	260	26	92	200	89.5	83.7	209	200	2	19.5
245	154	200	260	26	92	200	89.5	83.7	209	200	2	18.0
245	154	200	260	26	92	200	89.5	83.7	209	200	2	18.6
245	154	200	260	26	92	200	89.5	83.7	209	200	2	15.1
295	154	225	310	41	140	225	69	125.9	239	225	4	44.1
247	183	210	260	21.5	66	200	112	58.2	222	210	1.5	10.1
297	224	260	310	25	75	225	118	65.6	268	260	2	15.6
375	300.3	340	385	17	75	320	202	70	379	340	2.5	17.2
580	430.5	500	610	45	150	500	301.3	131.7	562	500	3.5	129

Double-direction Thrust Ball Bearing

d 25-95 mm

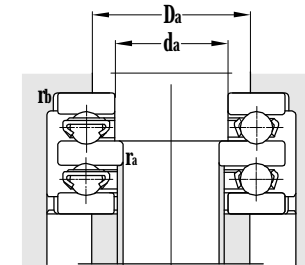
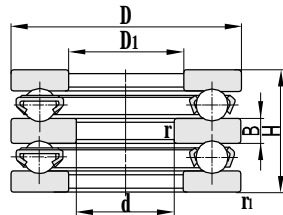

Principal dimensions				Basic load ratings		Limit speed ratings		
d	D	H	r _{min}	r _{1min}	C _r	C _{or}	Grease	Oil
					kN	r/min		
25	52	29	0.6	0.3	27.3	50.0	5000	6500
30	62	34	1	0.3	37.0	73.0	4800	6000
	68	44	1	0.3	88.5	148	4600	5800
	68	36	1	0.6	47	102.0	4500	5900
35	73	37	1	0.6	48.0	85.0	4200	5300
40	78	39	1	0.6	54.5	114	4000	5100
45	90	45	1	0.6	69.0	143	3800	5000
	120	87	1.5	0.6	191	385	3700	4900
50	95	46	1	0.6	74.0	147	3600	4800
55	100	47	1	0.6	75.5	160	3500	4700
	105	47	1	1	76.5	170	3400	4600
	125	72	1.1	1	148	315	3300	4500
	150	107	2	1	257	539	3250	4400
65	115	48	1	1	87.1	204	3300	4500
	180	128	1.1	1.1	545	1070	3100	4200
70	125	55	1	1	112	270	3200	4300
75	135	62	1.1	1	133	320	3100	4200
80	210	150	3	1.1	730	1550	3100	4100
	210	150	3	1.1	685	1470	3100	4100
85	150	67	1.1	1	163	340	3000	4000
	170	97	1.5	1	276	595	2950	3900
90	230	166	3	1.1	795	1800	2900	3800
95	160	67	1.1	1	170	395	2800	3700

Designations	Other dimensions		Abutment and fillet dimensions				Weight
	D1	B	d _{amin}	D _{amax}	r _{amax}	r _{bmax}	kg
mm							
52206	32	7	30	39	0.3	0.6	0.261
52207	37	8	35	46	0.3	1	0.354
52307	37	10	35	48	0.3	1	0.674
52208	42	9	40	51	0.6	1	0.496
52209	47	9	45	56	0.6	1	0.623
52210	52	9	50	61	0.6	1	0.722
52211	57	10	55	69	0.6	1	1.06
52411M	57	20	53	81	0.6	1.5	4.87
52212	62	10	60	74	0.6	1	1.25
52213	67	10	65	79	0.6	1	1.29
52214	72	10	64	102	1	1	1.37
52314	72	16	70	92	1	1	3.65
52414M	73	24	70	124	1	2	9.15
52216	82	10	80	94	1	1	1.73
52417M	88	29	86	124	1	1	16.0
52217	88	12	85	101	1	1	2.19
52218	93	14	90	108	1	1	3.11
52420M	103	33	101	145	1	3	25.3
52420	103	33	101	145	1	3	24.4
52220	103	15	100	120	1	1	4.05
52320	103	21	100	128	1	1	8.81
52422M	113	37	110	159	1	3	33.4
52222	113	15	110	130	1	1	4.51

Double-direction Thrust Ball Bearing

d 95-570 mm

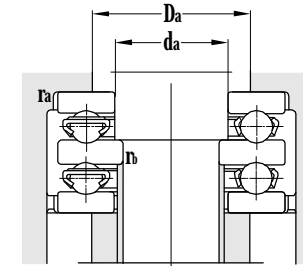
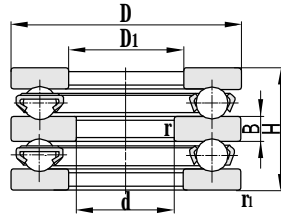

Principal dimensions				Basic load ratings		Limit speed ratings		
d	D	H	r _{min}	r _{1min}	C _r	C _{or}	Grease	Oil
					kN	r/min		
mm								
95	190	110	2	1	305	590	2700	3500
	190	110	2	1	305	590	2700	3500
	190	110	2	1	305	590	2700	3500
	250	177	4	1.5	1380	4140	2600	3300
100	170	68	1.1	1.1	137	430	2400	3000
	210	123	2.1	1.1	565	1420	2300	2800
110	190	80	1.5	1.1	230	575	2000	2500
	280	196	2	2	1020	2630	1600	2200
120	200	81	1.5	1.1	365	1090	1300	1800
	200	81	1.5	1.1	365	1090	1300	1800
	300	209	4	2	1100	2960	1000	1600
130	215	89	1.5	1.1	425	1300	900	1400
	250	140	2.1	2.1	430	1020	800	1200
	250	140	2.1	2.1	430	1020	800	1200
140	225	90	1.5	1.1	430	1380	700	1000
	225	90	1.5	1.1	430	1380	700	1000
150	250	98	1.5	2	760	3300	590	820
	250	98	1.5	2	760	3300	590	820
	300	165	3	2	835	2780	520	800
160	270	109	2	2	920	4080	500	760
	270	109	2	2	920	4080	500	760
170	280	109	2	2	910	4110	460	720
	340	192	4	2	1070	3730	430	680
300	400	80	1.8	1.3	430	3240	350	550
469.5	570	84	2	2	365	2720	230	360
570	700	90	3	1.3	292	2150	200	320

Designations	Other dimensions		Abutment and fillet dimensions				Weight
	D1	B	d _{amin}	D _{amax}	r _{amax}	r _{bmax}	kg
mm							
52322M	113	24	110	142	1	2	13.2
52322	113	24	110	142	1	2	12.9
52322U	113	24	110	142	1	2	13.22
52424M	249	40	246	173	1.5	4	42.1
52224	123	15	120	140	1	1	4.94
52324	123	21	120	157	1	2	17.3
52226M	133	18	130	156	1	1.5	8.60
52428	279	44	276	197	2	2	56.8
52228M	143	18	140	164	1	1.5	8.67
52228	143	18	143	164	1	1.5	8.37
52430	154	46	151	211	2	4	70.3
52230	153	20	150	176	1	1.5	10.3
52330M	154	31	150	176	1	2	31.2
52330	154	31	150	176	1	2	29.4
52232M	163	20	160	186	1	1.5	11.8
52232	163	20	160	186	1	1.5	11.7
52236M	183	21	180	208	2	1.5	15.6
52236	183	21	180	208	2	1.5	14.3
52336	184	37	180	208	2	3	48.8
52238	194	24	191	222	2	2	21.4
52238J	194	24	191	222	2	2	20.9
52240	204	24	201	232	2	2	22.1
52340	105	42	102	258	2	4	59.3
52768	340	18	337	388	1	1.5	21.2
52794X	499	29	493	557	2	2	39.9
527/615F1	615	20	612	684	1	3	53.7

Double-direction Thrust Ball Bearing With Aligning Seat and Washer



d 30-100 mm

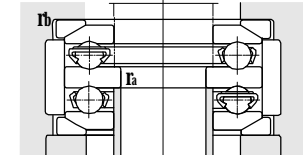
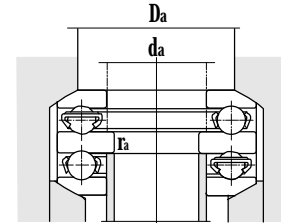
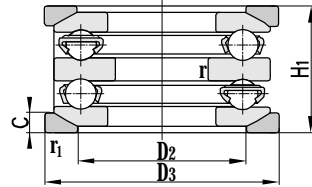
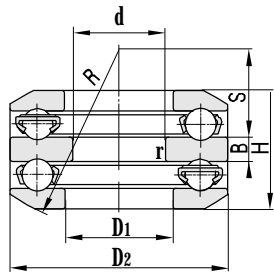

Principal dimensions					Basic load ratings		Designations
d	D	T	r _{min}	r _{1min}	C _r	C _{or}	
mm					kN		
30	68	47.2	1	0.3	90.2	147	54307+U307
40	64	35.4	0.6	0.6	41.1	99.3	54208+U208
85	170	105.4	1.5	1	450	1030	54320+U320
100	210	131.2	2.1	2.1	565	1420	54324M+U324
	210	131.2	2.1	2.1	565	1420	54324+U324

Other dimensions								Abutment and fillet dimensions				Weight
D1	D2	D3	b	C	H1	R	S	d _{amin}	D _{amax}	r _{amax}	r _{bmax}	
mm								mm				kg
37	52	72	10	7.5	52	56	21	35	52	0.3	1	0.909
42	48	69	7	7	42	50	20.9	40	48	0.6	1	0.563
103	135	175	21	18	115	125	42	100	135	1	1.5	10.8
123	165	220	27	22	143	160	58	120	165	2	2	23.0
123	165	220	27	22	143	160	58	120	165	2	2	22.2

Double-direction Angular Contact Ball Thrust Bearing

Product characteristic

This type bearing consist by two shaft washer, one housing washer with lubricating groove and oil hole, one spacer, double-row rolling element and cage. Through grinding the thickness of spacer, could adjust the clearance and preload of the bearing. Bearing contact angle is 60*. Can carrying combination load in double direction load(mainly axile load). This type of bearing is widely apply to the main shaft of grinding machine, boring machine, turning machine, milling machine and rilling machine, is the high precision bearing especially designed for these machine tools. This type of bearing with high precision, high rigidity, low temperature raise, high rotation speed and easily to mounting and dismounting.

Dimension range

Basic dimension is listed in the bearing dimension data sheet.

Inner diameter range: 50mm~300mm

Outer diameter range: 80mm~420mm

Width diameter range:38mm~144mm

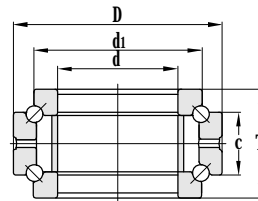

Tolerance

ZWZ double direction angular contact thrust ball bearing can provide SP, P4 level tolerance, can provide UP level tolerance if needed.

Tolerance of SP, UP level housing washer

μm

D mm		ΔDmp		ΔCs	
Over	To	High	Low	High	Low
30	50	-20	-27	0	-30
50	80	-24	-33		
80	120	-28	-38		
120	150	-33	-44		
150	180	-33	-46		
180	250	-37	-52		
250	315	-41	-59		
315	400	-46	-64		
400	500	-50	-70		
500	630	-55	-77		

Cage

The double direction angular contact thrust ball bearing made by ZWZ select machined brass cage, the suffix code not marked.

Preload

The preload of double direction angular contact thrust ball bearing is determined by spacer, the value of preload is list as follow table:

The preload value of double direction angular contact thrust ball bearing

N

Bearing ID Code		Preload						
Over	To	1	2	0	3	4	5	6
-	05	-	196	295	390	490	590	785
05	09	195	295	490	590	680	835	980
09	13	490	685	980	1175	1375	1670	1960
13	16	490	980	1470	1765	2060	2450	2945
16	19	490	980	1470	1765	2160	2550	2945
19	24	785	1175	1960	2450	2945	3435	4415
24	26	785	1470	1960	2450	2945	3925	4415
26	34	980	1470	1960	2450	2945	3925	4905
34	40	1470	1960	2450	2945	3925	4905	5885
40	56	1470	1960	2945	3925	4905	5885	6865
56	68	1960	2450	3435	4905	5885	6865	7850
68	80	1960	2450	3925	5885	6865	7850	8830

Tolerance of SP, UP level housing washer

μm

d mm		SP					UP			SP, UP	
		Δdmp		Δds		Si Se	Δds Δdmp		Si Se	ΔTs	
Over	To	High	Low	High	Low	max	High	Low	max	High	Low
-	30	0	-8	+1	-9	3	0	-6	1.5	+50	-30
30	50		-10	+1	-11	3		-8	1.5	+60	-100
50	80		-12	+2	-14	4		-9	2	+70	-120
80	120		-15	+3	-18	4		-10	2	+85	-140
120	180		-18	+3	-21	5		-13	3	+95	-160
180	250		-22	+4	-26	5		-15	3	+120	-200
250	315		-25	+5	-30	7		-18	4	+150	-250
315	400		-30	+5	-35	7		-23	4	+200	-300

Double-direction Thrust Angular Contact Ball Bearing

d 50-130 mm

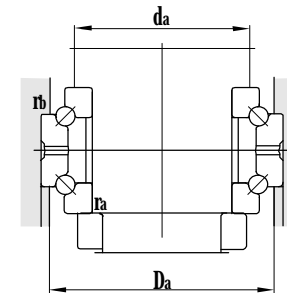
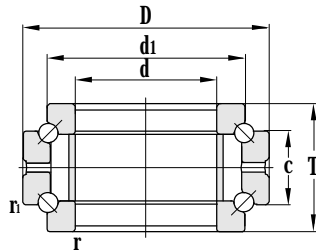

Principal dimensions				Basic load ratings		Limit speed ratings			
d	D	T	C	r _{min}	r _{1min}	C _r	C _{or}	Grease	Oil
mm				kN		r/min			
50	80	38	19	1	0.15				
	72	28	14	1	0.3				
70	110	48	24	1.1	0.3	42.5	93	5300	7000
75	115	48	24	1.1	0.3				
	105	38	19	1	0.5				
80	125	54	27	1.1	0.3	52	120	4500	6000
	110	38	19	1	0.5				
85	130	54	27	1.1	0.3				
	120	44	22	1	0.5				
90	140	60	30	1.5	0.3	108	400	4000	5300
	125	44	22	1	0.6				
95	145	60	30	1.5	0.3				
	130	44	22	1	0.6				
100	150	60	30	1.5	1	108	400	2900	3800
	150	60	30	1.5	1				
	140	48	24	1	0.6				
105	160	66	33	2	0.6	109	200	2600	3500
	145	48	24	1	0.6				
110	170	72	36	2	0.6				
	150	48	24	1	0.6				
120	180	72	36	2	0.6	139	265	2400	3200
	165	54	27	1	0.6				
130	200	84	42	2	0.6	119	360	2200	3000
	180	60	30	1.5	1				

Designations	Dimensions	Abutment and fillet dimensions				Weight
	d _{1max}	d _{amin}	D _{amax}	r _{amax}	r _{bmax}	
	mm	mm				kg
234410 234910	70					
	64					
234414	97	86.5	103.5	1.1	0.3	1.49
234415 234915	102					
	94					
234416 234916	110	98.5	117	1.1	0.3	2.16
	99					
234417 234917	115					
	106					
234418/SP5 234918	123	110.5	130.5	1.5	0.3	2.99
	111					
234419 234919	128					
	116					
234420 234420TN1 234920/P4YAB	133	119	142	1.5	0.3	3.19
	133	119	142	1.5	0.3	2.67
	126	117	134	1	0.6	2.04
234421/YA6 234921	142	125	151	2	0.6	4.15
	121					
234422 234922	150					
	136					
234424 234924	160	142	171	2	0.6	5.54
	150					
234426 234926	177	143	192	2	0.6	8.64
	163					

Double-direction Thrust Angular Contact Ball Bearing

d 140~260 mm

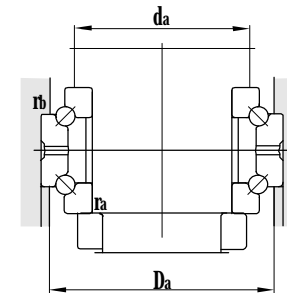
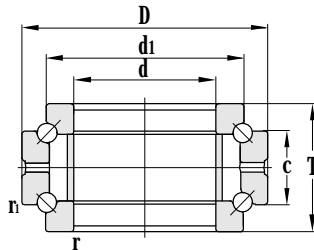

Principal dimensions				Basic load ratings				Limit speed ratings	
d	D	T	C	r _{min}	r _{1min}	C _r	C _{or}	Grease	Oil
						kN	r/min		
mm									
140	210	84	42	2.1	0.6	113	355	1800	2600
	210	84	42	2.1	0.6	113	355	2500	3600
	210	84	42	2.1	0.6	113	355	2200	3300
	190	60	30	1.5	1				
150	225	90	45	2.1	0.6	250	390	1700	2500
	210	72	36	2	1	151	320	1800	2600
160	240	96	48	2.1	1.1	241	680	1700	2300
	240	96	48	2.1	1.1	241	680	3000	4000
	240	84	36	2.1	1.1	132	445	1700	2300
	240	96	48	2.1	1.1	241	680	1800	2500
170	260	108	54	2.5	1.3	287	590	1600	2100
180	280	120	60	2.1	0.6	280	665	1500	2000
	280	120	60	2.1	0.6	280	665	2000	3000
	280	120	60	2.1	0.6	280	665	1500	2000
190	290	120	60	2.1	0.6	224	630	1900	2800
	260	84	42	2	1	150	625	2300	3300
200	310	132	66	2.1	0.6	230	765	1300	1700
	280	96	48	2	1				
220	300	96	48	2	1	210	930	1200	1700
	340	144	72	3	1	450	1890	1200	1600
240	320	96	48	2	1	270	1280	900	1300
	360	144	72	3	1	300	1090	800	1100
260	360	120	60	2.1	1.1	315	1390	1500	2100

Designations	Dimensions	Abutment and fillet dimensions				Weight
	d _{1max}	d _{amin}	D _{amax}	r _{amax}	r _{bmax}	
mm						
kg						
234428	187	166	200	2	0.6	8.97
234428/P4	187	166	200	2	0.6	8.97
234428/P5	187	166	200	2	0.6	8.97
234928	173					
234430/P4YAB	200	178	213	2	0.6	12.5
234930	190	172	200	2	1	7.26
234432	212	190	227	2	0.6	14.0
234432/P4YAB	212	190	227	2	0.6	14.0
234432X2	212	190	227	2	0.6	11.6
234432YA6	212	190	227	2	0.6	14
234434	230	206	245	2	1	18.5
234436	248	221	263	2.1	0.6	23.4
234436/P4YAB	248	230	270	2	1	24.8
234436/SP3	248	230	270	2	1	24.8
234438/P4YAB	258	231	273	2.1	0.6	24.7
234938/P5YB2	237					12.0
234440	274	243	300	2	1	33.6
234940	252					
234944/P5W33	272	250	287	2	1	17.0
234444	304	265	330	2	1	43.9
234948	292	253	310	2	1	19.7
234448	322	287	350	2.5	1	46.7
234952/P4	326	300	344	2	1	33.7

Double-direction Thrust Angular Contact Ball Bearing



d 280~1374.775 mm

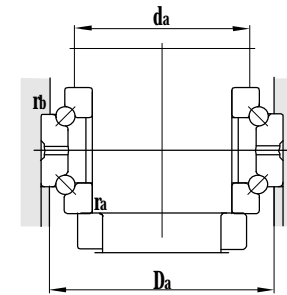
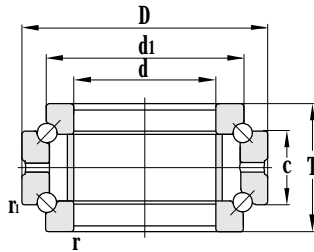

Principal dimensions						Basic load ratings		Limit speed ratings	
d	D	T	C	r _{min}	r _{1min}	C _r	C _{or}	Grease	Oil
mm						kN		r/min	
280	380	120	60	2	1	232	955	800	1200
	420	164	82	3	1.5	390	1270	700	1100
300	460	190	95	3	1.5	315	765	670	1100
	420	144	72	3	1				
420	620	236	118	5	2	590	2980	600	1000
460	680	256	128	6	2	665	3500	550	900
1374.775	1597.025	247.65	49.23	5	3	3000	17300	500	800

Designations	Dimensions	Abutment and fillet dimensions				Weight
	d _{1max}	d _{amin}	D _{amax}	r _{amax}	r _{bmax}	
	mm	mm				kg
234956	348	323	365	2.5	1	44.9
234456	374	337.5	394.5	4	1.5	69
234460	406					
234960	384					
234484/P4	552	441	607	5	2	222
234492/SP	608	485	667	6	2	291
2327/1374X4/HCEP5	1536.7	1395	1580	5	3	648

Cylindrical Roller Thrust Bearing

Product Characteristics

Consists washer type raceway rings (shaft washer, housing washer), cylindrical roller and cage. Cylindrical roller adopt convexity process, so the stress between roller and raceway is equally distributed.

This type of bearing is separable structure, can install shaft washer, housing washer, rolling element components separately. The lean between shaft and housing is not allowed while mounting.

This type of bearing is suitable for low rotation speed, can carrying single direction axial load, can not limit radial displacement, have large axial load carrying capacity, and also higher axial rigidity.

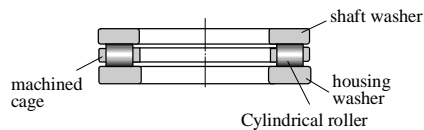

Product Category

- Single direction cylindrical roller thrust bearing
- Double direction cylindrical roller thrust bearing

Dimension range:

Inner diameter dimension range:

30mm~1800mm

Outer diameter dimension range :

52mm~2080mm

Width dimension range:

14mm~250mm

Tolerance

The tolerance of cylindrical roller bearing made by ZWZ is according to standard GB307.4. The value of tolerance please refer to the table in preface. ZWZ can provide P0, P6, P5 and P4 class products.

Cage

Brass machined solid cage is normally selected for cylindrical roller thrust bearing which made by ZWZ.

While Bearing outer diameter $D \leq 500\text{mm}$, choose brass cage;

While bearing outer diameter $D > 500\text{mm}$, choose steel solid cage, cage suffix code not marked, other shall mark the suffix code accordingly.

Equivalent dynamic load

$$P = Fa$$

Equivalent static load

$$P_0 = Fa$$

Related bearing code explanation:

- X1- Non-standard outer diameter.
- X2- Non-standard width (height).
- X3- Non-standard outer diameter, width (height) (standard bore diameter)
- F1- Carbon steel
- F3- Nodular cast iron
- HC- Ring and rolling elements or only ring or rolling elements are made from case hardened steel (/HC-20Cr2Ni4A; /HC1-20Cr2Mn2MoA; /HC2-15Mn; /HC3-G20CrMo).
- M- Brass solid cage
- TN1- Nylon
- P5- Tolerance grade conforms to the standard P5.
- P4- Tolerance grade conforms to the standard P4.
- SP- Ultra precision grade, dimension tolerance equals to P5, rotating precision equals to P4.
- YB2- Bearing dimension and tolerance changed.
- YB5- Structure and position tolerance have special requirements.
- ZW- Double-row needle rollers and cage assembly.

Thrust Cylindrical Roller Bearing

d 30–200 mm

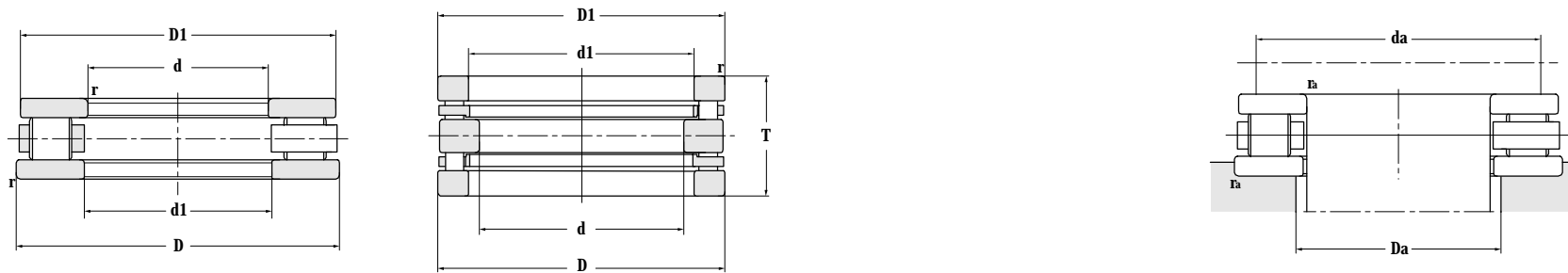

Principal dimensions				Basic load ratings		Limit speed ratings		Designations
d	D	T	r _{min}	C _r	C _{or}	Grease	Oil	
mm				kN		r/min		
30	52	16	0.6	59.4	129	3200	3800	81206TN1
30.05	54	13.8		41.3	113	3200	3800	81206X2ZRS
38.5	66.7	18		71	190	2200	2500	817/38.5-ZS
42	65	14	0.6	45.1	113	2000	2300	811/42TN1
50	78.6	22		103	300	1500	1800	81210X1ZSTN1
	82	22		69	223	1500	1800	81210X1ZRS
	80	18.89		72.5	245	1500	1800	81210X2ZRS
75	135	36	1.5	265	885	640	860	89315
80	115	28	1	140	505	690	920	81216
85	150	39	1.5	300	1120	1420	1900	89317/P4
100	150	38	1.1	230	880	540	720	81220
110	160	38	1.1	264	878	900	1300	81222
120	155	25	1.1	154	653	950	1400	81124
140	180	31	1	193	850	670	900	81128
160	200	31	1	216	1020	630	850	81132
175	250	82	2	325	1580	400	530	82635
180	250	56	1.5	545	2300	280	380	81236
	360	82	5	1580	6270	340	450	87436ZW
	360	109	5	2090	6240	800	1200	89436ZW
	360	109	5	2090	6240	800	1200	89436ZW-1/HC
200	280	62	2	700	3000	360	500	81240
	250	37	1.1	325	1530	530	700	81140

Other dimensions		Abutment and fillet dimensions			Weight
d1	D1	damin	Damax	ramax	
mm		mm			kg
32	52	48	33	0.6	0.127
30.2	54	50	32		0.113
42	66.7	62	40		0.232
44	65	63	42	0.6	0.147
50.5	78.6	75	53		0.381
50.3	82	80	51		0.439
50.1	74.2	72	48		0.333
77	135	130	80	1.5	2.42
82	115	113	85	1	1.03
88	150	146	92	1.5	3.12
103	150	146	106	1	2.61
113	160	156	117	1	2.80
120.2	155	150	125	1	1.24
142	178	175	145	1	2.07
162	198	195	165	1	2.33
203	247	240	208	2	11.9
183	247	245	185	1	9.37
184	358	350	195	4	41.7
184	355	345	194	4	59.3
184	360	350	194	4	60
204	277	275	210	2	13.0
203	247	243	206	1	43.6

Thrust Cylindrical Roller Bearing

d 200~380 mm

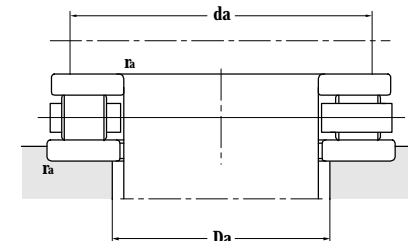
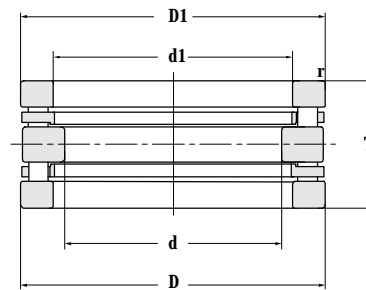
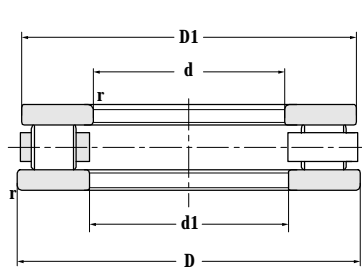

Principal dimensions				Basic load ratings		Limit speed ratings		Designations
d	D	T	r _{min}	C _r	C _{or}	Grease	Oil	
mm				kN		r/min		
200	340	85	4	1540	5170	210	280	89340 89340/P5YB5
	340	85	4	1540	5170	210	280	
220	270	37	1.1	320	1630	240	320	81144 81244
	300	63	2	750	3350	360	480	
240	300	45	1.5	490	2350	420	2280	81148 81248
	340	78	2.1	1080	4730	190	250	
260	320	45	1.5	515	2500	430	560	81152 81252 81252/HC 87452X1ZW 89452ZW/P5YB5 89452ZW/YB5
	360	79	2.1	1140	5300	280	380	
	360	79	2.1	1140	5300	280	380	
	420	100	6	2050	10000	160	210	
	480	132	6	3000	12900	200	300	
	480	132	6	3000	12900	200	300	
280	350	53	1.5	653	3410	170	230	81156 81256 81256F1 81256/P5YB5
	380	80	2.1	1130	5280	250	350	
	380	80	2.1	1130	5280	250	350	
	380	80	2.1	1130	5280	250	350	
300	420	95	3	1540	6910	190	250	81260 81260F1 81260/YB5 82760ZW 89460ZW/P4YB5
	420	95	3	1540	6910	190	250	
	420	95	3	1470	5950	190	250	
	460	80	3	780	5600	300	400	
	540	145	6	3740	15400	190	280	
340	460	96	3	1630	8000	200	300	81268 89468ZT
	620	170	10	4480	21000	140	190	
360	440	65	2	890	4030	180	270	81172/P5 81272 81272X3M/YB2
	500	110	4	2160	10400	180	260	
	520	82	4	2220	11600	120	160	
380	460	65	2	930	5300	260	360	81176 81276M
	520	112	4	2290	10800	180	260	

Other dimensions		Abutment and fillet dimensions			Weight
d1	D1	d _{amin}	D _{amax}	r _{amax}	
mm		mm			kg
205	340	332	215	3	35.1
205	340	332	215	3	35.1
223	267	265	225	1	4.83
224	297	290	230	2	13.6
243	297	292	248	1.5	7.43
244	335	330	250	2	24
263	317	315	268	1	8.84
264	355	351	280	2	25.4
264	355	351	280	2	25.4
264	419.5	410	274	5	59.7
265	480	470	275	5	117
265	480	470	275	5	117
283	347	345	285	1	12.4
284	375	372	300	2	29.2
284	375	372	300	2	29.4
284	375	372	300	2	29.4
304	415	413	328	3	41.6
304	415	413	328	3	41.3
304	415	413	328	3	41.6
300	460	454	304	3	54.6
305	540	533	331	5	152
345	455	452	367	2.5	47
342	615	600	360	9	241
364	436	372	428	1.5	22.7
365	495	492	375	3	69.9
365	515	510	375	3	61.5
384	456	453	393	2	22.5
385	515	510	390	3	74.4

Thrust Cylindrical Roller Bearing

d 380~572 mm

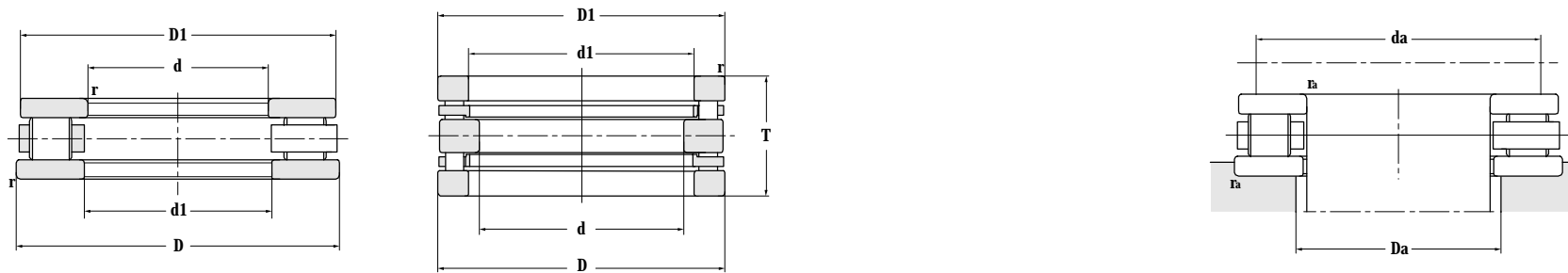

Principal dimensions				Basic load ratings		Limit speed ratings		Designations
d	D	T	r _{min}	C _r	C _{or}	Grease	Oil	
mm				kN		r/min		
380	560	112	4	2920	12800	180	260	81276X1M
	560	112	4	2920	12800	180	260	81276X1M/YB2
400	480	65	2	1000	5380	110	150	81180
420	500	65	2	940	5620	200	280	81184
440	540	80	2.1	1430	1680	170	230	81188
	600	130	5	2850	12800	90	120	81288
460	560	80	2.1	1400	8160	210	290	81192/P5
	800	206	9.5	6500	32000	110	150	89492ZT
480	580	80	2	1550	8300	150	200	81196F1
	580	80	2	1550	8300	150	200	81196F3
	580	80	2	1550	8300	150	200	81196M
	650	135	5	3350	17000	130	180	81296M
500	600	80	2.1	1600	9000	150	200	811/500
	670	135	5	3520	3600	140	190	812/500
	670	135	5	3520	3600	140	190	812/500F3
	670	135	5	3520	3600	140	190	812/500/YB5
508	762	139.7	6.4	4950	26200	110	150	817/508/P5YB5
	762	139.7	6.4	4950	26200	110	150	817/508/P4YB5
530	640	85	3	1750	9700	180	250	811/530
	640	85	3	1750	9700	450	600	811/530/SPYB5
	710	140	5	3650	18600	320	450	812/530/P5YB5
560	670	85	3	1760	11100	180	260	811/560
	750	150	5	4200	20100	150	230	812/560
	820	200	7.5	5950	28800	130	210	817/560/YB5
	820	200	7.5	5950	28800	130	210	817/560/P4YB5
572	763	115	5	3360	22900	110	160	817/572ZW/P4YB5

Other dimensions		Abutment and fillet dimensions			Weight
d1	D1	d _{amin}	D _{amax}	r _{amax}	
mm		mm			kg
385	555	550	390	3	99.5
385	555	550	390	3	99.5
404	476	473	404	1.5	25.8
424	495	493	433	1.5	27.2
444	535	415	525	2	41.5
445	595	533	459	4	114
464	555	553	479	2	43.7
462	795	775	480	9	464
484	575	573	500	1.5	44.1
484	575	573	500	1.5	44.1
484	575	573	500	1.5	44.6
485	645	520	641	4	135
505	595	592	519	2	45.3
505	665	655	515	5	137
505	665	655	515	5	137
505	665	655	515	5	137
511.18	758.83	748	520	5	238
511.18	758.83	748	520	5	238
534	635	632	554	2.5	56.7
534	635	632	540	2.5	56.7
535	705	701	545	4	154
565	665	662	584	2.5	60
565	745	735	584	4	203
565	815	800	584	6	379
565	815	800	584	6	379
574	760	750	585	4	147

Thrust Cylindrical Roller Bearing

d 600~900 mm

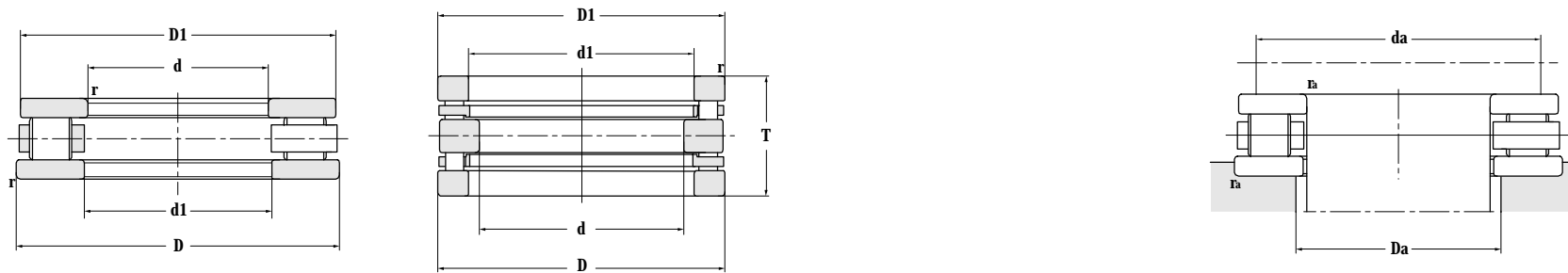

Principal dimensions				Basic load ratings		Limit speed ratings		Designations
d	D	T	r _{min}	C _r	C _{or}	Grease	Oil	
mm				kN		r/min		
600	710	85	3	1730	11100	170	260	811/600
	800	160	5	4400	24000	110	160	812/600
	800	160	5	4400	24000	110	160	812/600/P4YB5
610	710	65	2	1300	8250	170	260	817/610/P4YB5
650	930	130	4	5300	37000	150	230	817/650ZW
710	950	190	6	5860	29200	120	150	812/710/P4YB5
	950	290	6	6330	26200	120	150	822/710
	850	85	4	2200	14300	150	230	891/710/P4YB5
711.45	846.4	95.25	6.4	2360	17700	170	260	817/711X4ZW
750	900	120	4	3250	21200	120	170	811/750/SPYB5
	1000	195	6	6550	36000	85	120	812/750/YB5
	1000	195	6	6550	36000	85	120	812/750/P4YB5
765	1360	220	15	15000	91000	80	100	817/765ZWF1
	1360	220	15	15000	91000	80	100	817/765ZWF3
800	950	120	4	3400	22000	130	180	811/800
	1060	205	7.5	7300	40000	80	100	812/800
812.8	1016	127.127	2.3	5150	33500	80	100	817/812.8/P5YB5
850	1000	120	4	3400	23000	100	150	811/850
	1120	212	7.5	8000	45000	80	100	812/850/YB5
	1120	212	7.5	8000	45000	130	180	812/850/P4YB5
860	1000	96	3	2200	16200	130	180	817/860/P4YB5
900	1060	130	5	4000	27000	100	150	811/900
	1180	125	7.5	6050	8300	100	130	872/900ZWF1/HC

Other dimensions		Abutment and fillet dimensions			Weight
d1	D1	d _{amin}	D _{amax}	r _{amax}	
mm		mm			kg
604	705	702	624	2.5	63.4
605	795	651	789	4	240
605	795	651	789	4	240
610	710	705	615	1.5	50.7
650	930	925	655	3	318
718	942	932	728	5	387
750	945	935	760	5	564
715	850	845	720	3	99.9
672.84	831.8	820	680	5	113
755	895	890	760	3	160
758	992	982	768	5	468
758	992	982	768	5	468
805	945	940	810	3	170
810	1050	1040	820	6	520
815.8	1016	1010	820	2	260
855	995	990	860	3	175
860	1110	1100	870	6	622
860	1110	1100	870	6	622
860	1000	995	865	2	148
906	1054	1045	915	4	220
905	1175	1160	920	7.5	393

Thrust Cylindrical Roller Bearing

d 900~1800 mm

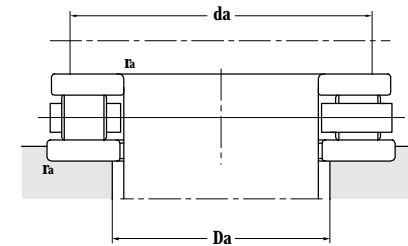
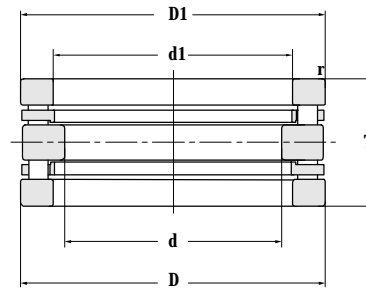
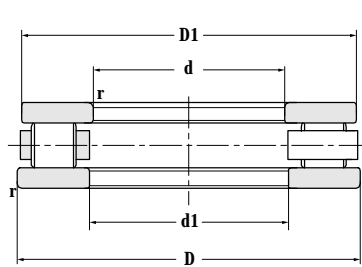

Principal dimensions				Basic load ratings		Limit speed ratings		Designations
d	D	T	r _{min}	C _r	C _{or}	Grease	Oil	
mm				kN		r/min		
900	1180	220	7.5	8000	48000	70	100	812/900
950	1120	135	5	4000	30000	90	140	811/950 812/950
	1250	236	7.5	10000	58000	60	90	
1000	1180	140	5	4700	32000	90	120	811/1000 812/1000
	1320	250	9.5	10100	58000	60	80	
1060	1250	150	5	5300	36500	80	110	811/1060
1120	1320	160	5	6000	41500	80	100	811/1120
1180	1400	100	6	4730	7200	87	110	871/1180ZW/HC
1320	1540	100	6	5450	5900	80	100	871/1320ZW/P4YB5
1800	2080	150	7.5	9320	87000	60	90	871/1800/P4YB5

Other dimensions		Abutment and fillet dimensions			Weight
d1	D1	damin	Damax	ramax	
mm		mm			
910	1170	1160	920	6	660
956	1114	1105	965	4	250
		960	1240	1230	970
1006	1174	1165	1015	4	290
		1012	1308	1290	1030
1066	1244	1235	1075	4	230
1126	1314	1305	1135	4	410
1185	1395	1385	1195	5	308
1325	1535	1525	1335	5	348
1810	2070	2060	1820	6	858

Tapered Roller Thrust Bearing

Product Characteristics

This type of bearings are equipped with cone-shaped rollers (with larger spherical end) and the rollers are precisely guided by the integral flanges of the washers (shaft washer and housing washer) with raceways. When extended, the design makes the shaft washer, housing washer, raceway surface and the circular conical surfaces of rollers' sliding surface converge towards to the same single point on the bearing axis. Single-direction bearings can carry axial load in one direction. Double-direction bearings can carry axial load in two directions. The middle washer of double-direction bearings is connected with the shaft, but due to the clearance inside, a sleeve must be used to fix the middle washer in the axial direction.

The tapered roller thrust bearings with housing can avoid dirt entering and roller falling. As without cage, more rollers can be put in, therefore the bearings can carry bigger axial load, but due to the lower limit rotation speed, axial load can only be suffered in one direction.

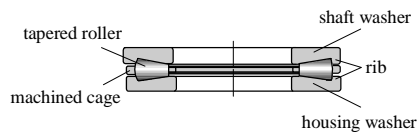

Applications of tapered roller thrust bearings:

Single-direction bearings: shaft washer is the same as housing washer (all with ribs), suitable for radial direction fixing, are mainly found in crane hooks and rotating platforms of oil drillings, etc.

Full rollers bearings are used when axial load is bigger.

During rotation, little shaft eccentric can be allowed for the bearings with plane housing washer raceway.

Double-direction bearings: in the mill roll necks.

Product types

- Single-direction tapered roller thrust bearings
- Double-direction tapered roller thrust bearings
- Tapered roller thrust bearings with housing

Dimension range

Bore diameter range: 38.4mm-670mm

Outer diameter range: 66mm-900mm

Width range: 18mm-319mm

Tolerance

The tolerances of ZWZ tapered roller thrust bearings are standardized as GB307.4. The clearance dimensions can be found in preface form. ZWZ can supply bearings with P0, P6 P5 and P4 classes.

Cage

ZWZ tapered roller thrust bearings generally use brass solid cages and other machined solid cages. When they use brass solid cages, there is no suffix in the bearing code name. When they use other cages, there is relative suffix in the bearing code name.

Axial equivalent dynamic load rating

$$P_a = F_a$$

Axial equivalent static load rating

$$P_{0a} = F_a$$

Related Bearing Code explanation:

- X1- Non-standard outer diameter.
- X2- Non-standard width (height).
- X3- Non-standard outer diameter, width (height) (standard bore diameter)
- X4- Inner diameter select the integer of non-standard bearing, while inner diameter is not integer and have two and more decimal places, indicated by X4 as select integer of the figures.
- V- Full complement rolling elements (without cage)
- /HG- Ring and rolling elements or only ring are made by other bearing steel (/HG-5GrMnMo; /HG1-55SiMoVA; /HG2-GCr18Mo; /HG3-42CrMo/ HG4-GCr15SiMn).
- /W281- Indicates the metallurgical bearings (execute standard Q/WZ.J14281)
- Q1- Aluminum iron manganese bronze.
- F1- Carbon steel
- F3- Nodular cast iron
- /HA- Ring rolling elements and cage or only the ring and rolling elements are made from vacuum smelted bearing steel.
- /HC- Ring and rolling elements or only ring or rolling elements are made from case hardened steel (/HC-20Cr2Ni4A; /HC1-20Cr2Mn2MoA; /HC2-15Mn; /HC3-G20CrMo).
- M- Brass solid cage
- YA2- Bore of inner ring has changed comparing to the standard design.
- YA3- End face of bearing ring has changed comparing to the standard design.
- YAD- One type of bearing has two or more changes on structure.

Single-row Thrust Tapered Roller Bearing

d 38.4~210 mm

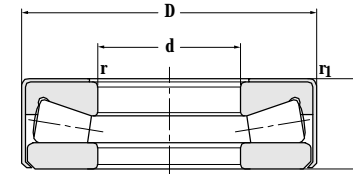
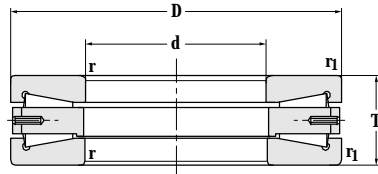

Principal dimensions					Basic load ratings	
d	D	T	r _{min}	r _{1min}	C _r	C _{or}
mm					kN	
38.4	66	18	0.6	2.5	96.5	300
42.1	70	18	1	2.5	106	224
45.1	73	18	1	2.5	100	350
47	78	22	1	2.5	89	325
50	80	19	0.6	2	120	345
	78	22	0.8	2.5	120	350
	78	22	1	2	78	275
50.1	83	22	2	2	132	350
52.4	85	22	1	1	134	460
60	130	42	1.5	1.5	365	1035
75	160	51	2	2	540	1570
111.76	223.52	55.88	3.3	3.3	980	3850
140	280	85	4	4	1550	5650
177.8	368.3	82.55	8	8	2190	7750
	431.8	101.6	6.4	3.3	3100	12800
180	360	109	5	5	250	8950
203.2	419.1	92.075	9.7	9.7	2670	11600
	200	400	122	5	2960	8670
	405.638	111.506	4	4	3030	11400
210	460	150	10	2.3	3550	12700
	460	150	10	2.3	3550	12700

Designations	Weight
	kg
917/38.4PZSV	0.25
917/42.1PZSV	0.272
917/45.1PZSV	0.297
917/47ZSV/YA	0.409
91210X2PZSV	0.366
91210X3PZSV	0.385
91710ZSV/YA	0.371
917/50.1PZSV	0.446
917/52.4ZSV	0.505
99412	2.88
99415	5.3
917/111X4	11.8
99428	26.1
917/177.8	47.6
917/177.8-1	87.6
99436	55.9
KT811	70.6
99440	80
91740/YA3	75.1
91742	143
91742F1	135

Single-row Thrust Tapered Roller Bearing



d 220~406.4 mm

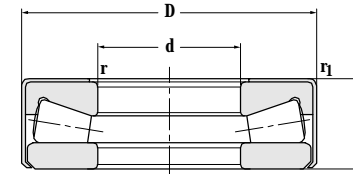
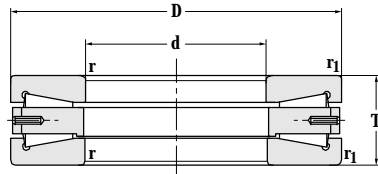

Principal dimensions					Basic load ratings	
d	D	T	r _{min}	r _{1min}	C _r	C _{or}
mm					kN	
220	330	65	2	2	900	3500
	330	65	3	2.1	915	4100
228.6	482.6	104.775	11.2	11.2	3350	15500
	482.6	104.775	11.2	11.2	3350	15500
234.95	482.6	104.775	11.2	11.2	3350	15500
	546.1	127	16	16	5350	20500
240	350	65	2.1	2.1	1020	4950
260	480	132	6	6	3650	11900
	480	130	6	6	6150	26750
270	540	130	6	6	6150	26750
	540	130	6	6	6150	26750
279.4	603.25	136.525	11.2	11.2	5770	21800
280	520	145	6	6	6050	20700
	520.4	145	6	6	6050	20700
320	440	95	3	3	1650	5800
	580	155	7.5	7.5	5350	14300
340	710	160	4	4	8800	32500
360	500	110	4	4	2000	7500
365	710	160	5	5	6250	31500
380	670	175	7.5	7.5	6890	23500
400	540	112	4	4	2240	7900
406.4	711.2	146.05	9.7	9.7	6160	25400

Designations	Weight
	kg
1-9017M/HG2	20.7
91744/HG2	21
917/228.6	101
917/228.6/HCYAD/W281	99.6
917/234X4	99.2
917/234X4-1	174
99248X3M/HG2	22.2
99452	115
91754	165
91754Q1	164
917/279.4	217
99456	157
99456X1	158
91264	43.4
99464	193
91768	339
91272	69.5
1-9011	328
99476	290
91280	77.8
917/406.4Q1	279

Single-row Thrust Tapered Roller Bearing



d 420~600 mm

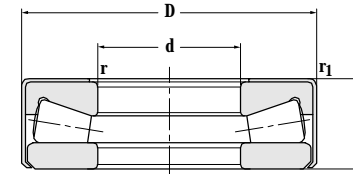
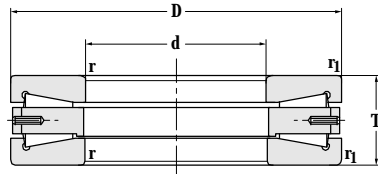

Principal dimensions					Basic load ratings	
d	D	T	r _{min}	r _{1min}	C _r	C _{or}
mm					kN	
420	740	95	5	5	2460	29200
431.8	863.6	228.6	10.2	10.2	15100	69500
460	800	206	9.5	9.5	7250	31500
480	680	120	5	5	3550	16800
480	850	224	9.5	9.5	9000	40000
500	750	190	6	6	6260	23500
520	900	224	9.5	9.5	10400	39900
560	730	115	5	2.3	2566	6423
600	860	125	6	6	4450	32300

Designations	Weight
	kg
99284X1/HC	198
917/431.8/HC	701
99492	487
1-9012	179
99496	613
913/500X2	325
917/520	661
917/560F1/HC	126
917/600/HC	269

Double-direction Thrust Tapered Roller Bearing

d 160~320 mm

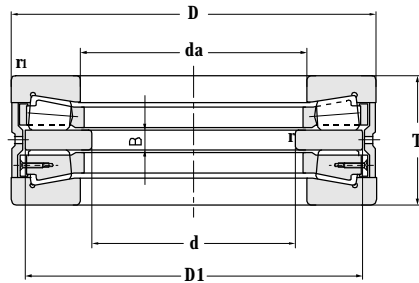

Principal dimensions			Basic load ratings		Designations
d	D	T	C _r	C _{or}	
mm			kN		
160	260	66	230	1470	92232X3
	300	110	580	2900	829232
	240	84	380	1460	92732X3
170	240	84	330	1300	92734
	240	84	330	1300	92734/W281
180	280	90	580	2900	353162
	280	90	500	2720	92736
	280	90	500	2720	92736/W281
220	300	96	510	4500	92744
	300	96	510	4500	92744/HC
	372	195	1380	5400	92744/HCYA2-1
230	400	180	980	4800	829746
	475	300	3050	26500	92746/HCEYAD
240	320	96	640	2300	92748
250	380	100	900	5000	92750
	380	100	900	5000	92750/YA2
	380	100	900	5000	92750/YA2/W281
	380	100	900	5000	92750/HCYA2
260	360	92	630	3200	350981C
	360	92	540	2830	92752
270	450	180	1400	6600	92754
291	520	266	2570	4050	1-9014
300	420	100	1050	4450	92760
	420	100	1050	4450	92760/HC
320	470	130	1600	8000	92764/HC

Other dimensions					Weight
da	D1	B	r _{min}	r _{1min}	
kN					kg
190	195	18	1	1.5	12.3
186	190	34	1	1.5	3.5
182.5	184	20	0.6	2	12
182.5	184	20	0.6	2	12.9
182.5	184	20	0.6	2	12.9
192	196	20	1	2	21
192	196	20	1	2	20.9
192	196	20	1	2	20.9
231	236	22	0.6	2	19.7
231	236	22	0.6	2	19.7
260	254	75	0.6	2	86.9
254	260	42	1	3	114
285	296	110	3	12	256
314	256	22	0.6	2	21.6
268	275	22	0.6	2	40.8
268	275	22	0.6	2	37.5
268	275	22	0.6	2	37.5
268	275	22	0.6	2	37.5
276	285	20	1	2	27.7
278	285	20	1	2	27.1
305	310	45	2	5	115
349	483	118	2	12	239
324	330	23	1.5	2.5	39.7
324	330	23	1.5	2.5	39.7
350	446	30	1.1	3	77.6

Double-direction Thrust Tapered Roller Bearing

d 320~470 mm

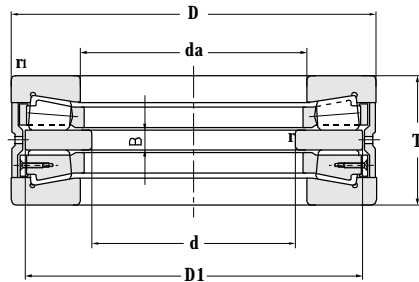

Principal dimensions			Basic load ratings		Designations
d	D	T	C _r	C _{or}	
mm			kN		
320	440	108	1010	4750	92764-1
	440	108	1010	4750	92764/HC-1
	470	130	1350	5800	350982C
336	630	319	3400	5150	1-9013
348	490	130	1200	7200	92770B
	490	136	1200	7200	92770B-1
350	490	130	1200	7200	92770
	540	135	2050	11000	92770X3
	540	199	1770	9060	92770X3/HC-1
	490	130	1200	5300	351100C
	540	135	1750	9200	353006
360	560	200	2400	12500	829272
	530	145	1170	7950	92772
380	530	130	1650	9850	92776
	530	130	1650	9850	92776-1
	560	130	1760	9700	92776/YA2
	560	130	1760	9700	92776/HCYA2
	650	215	3400	17000	BFDB353204
400	650	200	2700	13800	829780
420	620	185	2420	12200	92784/HC
	620	185	2700	13000	92784/YA2
440	650	240	3000	15800	92788/YA2
	650	240	3000	15800	92788-DNL
460	680	215	3200	16000	92792/HC
470	720	200	3450	18000	353151
	720	210	3450	18000	BFDB353238/HA3

Other dimensions					Weight
da	D1	B	r _{min}	r _{1min}	
kN					kg
348	355	26	1.1	3	45.4
348	355	26	1.1	3	45.4
340	350	30	1.1	3	79
415	578	130	3	13	425
380	390	30	1	3	99.5
380	390	30	1	3	104
380	390	30	1.1	3	70.1
388	400	30	1.1	4	107
402	410	100	1.5	3	161
380	390	30	1.1	3.5	73.5
384	400	30	1.1	4	112
382	396	48	1.5	4	180
400	410	45	2	4	105
398	410	30	3	5	90.1
398	410	30	3	5	90.1
418	430	32	1.5	3	106
418	430	32	1.5	3	106
446	450	65	2	5	275
436	450	50	1.5	5	
420	465	50	1.5	3	200
463	470	50	1.5	3	187
485	493	90	2	6	270
485	493	90	2	6	271
504	510	90	2	4	271
515	535	50	3	4.5	285
515	535	60	3	4.5	305

Double-direction Thrust Tapered Roller Bearing

d 480~670 mm

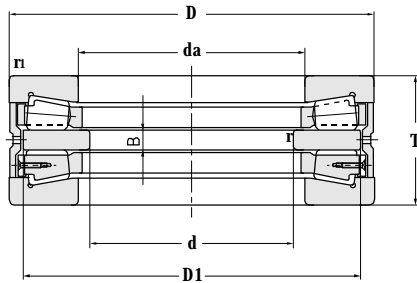

Principal dimensions			Basic load ratings		Designations
d	D	T	C _r	C _{or}	
mm			kN		
480	710	218	2900	13000	829796
530	710	218	2300	14000	351475C
550	760	230	2950	13500	350976C
600	880	290	4750	21500	BFDB350824B/HA1
670	900	230	3600	19500	927/670/HC

Other dimensions					Weight
da	D1	B	r _{min}	r _{1min}	
kN					kg
560	575	57	3	4.5	
560	575	57	3	4.5	245
585	610	50	3	4.5	310
670	680	70	4	5	550
725	870	50	2	5	396

Screw Down Tapered Roller Thrust Bearing

d 120~750 mm

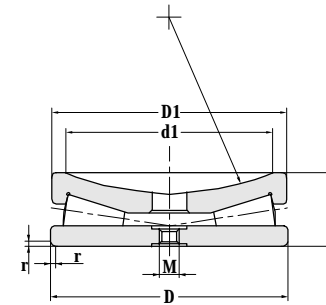
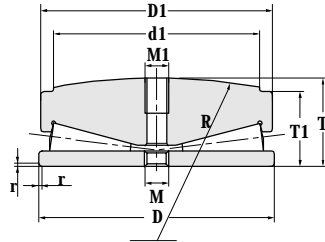

Outer diameter	Bearing designation		Boundary dimension			
	Old designation	New designation	D	D1	T	T1
120	4397/120	TTSX120	120	118	45	38
205	4397/205	TTSX205	205	203	75.6	65
235	4297/235/HG2I	TTSV235/HG2I	235	233	73	
380	4397/380/HC	TTSX380/HC	380	378	129	112
410	4397/410/HC	TTSX410/HC	410	408	142	122
495	4397/495/HC	TTSX495/HC	495	492	172	146
525	4397/525/HC	TTSX525/HC	525	522	180	155
533.4	4397/533.4/HC	TTSX533.4/HC	533.4	533.4	177.8	144
555	4397/555/HC	TTSX555/HC	555	553.26	190.86	165.1
555.63	4397/555X2/HC	TTSX555X4/HC	555.63	553.26	190.86	165.1
609.6	4397/609.6/HC	TTSX609.6/HC	609.6	607.24	204.01	177.8
640	4397/640/HC	TTSX640/HC	640	637	214.5	185
641.35	4397/641X4/HC	TTSX641X4/HC	641.35	638.99	212.67	184.15
750	4397/750/HC	TTSX750/HC	750	745	260	220

Boundary dimension					Axile static load	Weight
d1	R	M	M1	r _{min}		
kN						kg
105	300	M10	M12	1.5	800	3.16
178	508	M12	M16	1.6	2210	15.8
208	280	M20		1.5	5100	18.3
330	914.4	M24	M30	2	15300	91.4
355	1016	M24	M30	3	18000	115
432	1066.8	M24	M36	3	28100	210
460	1270	M24	M36	3	30000	245
457.2	1981.2	M24	M36	3.2	30000	251
482.6	1270	M24	M42	3.2	37000	301
482.6	1270	M24	M42	3.2	37000	301
533.4	1524	M30	M42	3.3	46000	383
550	1520	M30	M42	3	82200	439
558.8	1524	M24		3.2	52900	426
650	1600	M30	M48	4	64000	718

Spherical Roller Thrust Bearing

Product Characteristics:

The same as self-aligning roller bearings, the housing washer raceway surface is spherical which takes the same point of the bearing central axle as the spherical center point. The rollers of these bearings are of spherical shape, therefore they are self-aligning. They are not so sensitive to eccentricity and bending of the shaft.

Different with other thrust bearings, these bearings are featured by the extremely big axial load carrying capacity and meanwhile they can also carry a certain radial loads, however, the radial load should not exceed 55% of the axial loads. If the load P and P0 do not exceed 0.05Co and the shaft washer rotates, then the following angles of misalignment are permissible:

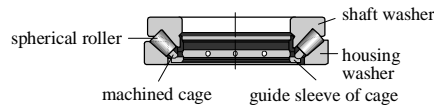

Bearing diameter series	Aligning angle
200 series	1° ~ 1.5°
300 series	1.5° ~ 2°
400 series	1.2° ~ 3°

The figures with small values are suitable for comparatively large size bearings and when the load increases, the permissible misalignment shall decrease.

Oil lubrication is commonly used while working.

Applications of these bearings can be found in hydroelectric generators, vertical motors, propeller axle of vessels, tower cranes and squeezing presses, etc.

Product types

- Symmetric self-aligning roller thrust bearings
- Asymmetric self-aligning roller thrust bearings

Dimension Range

The Principal dimensions of ZWZ self-aligning roller thrust bearings have been listed in dimension table.

- Bore diameter range: 60mm-1260mm
- Outer diameter range: 130mm-1860mm
- Width range: 39mm-426mm

Tolerance

ZWZ can supply bearings with P0, P6 P5 and P4 classes.

Cage

ZWZ self-aligning roller thrust bearings generally use brass solid cages and pressed cages. When they use the brass solid cages, there is no suffix in the bearing code name. When they use other cages, there is relative suffix in the bearing code name.

Minimum axial load

The minimum axial load Fa min. required by the self-aligning roller thrust bearings when they are working is the bigger value of the two calculated according to the following two formulas:

Where:

- Famin: the minimal axial load kN required
- N: rotation speed r/min
- Coa: basic static load rating kN
- Fr: radial load kN

$$F_{amin} = \frac{Coa}{2000}$$

$$F_{amin} = 1.8Fr + 1.33 \left(\frac{Coa}{2000} \right)^2 \times 10^{-7}$$

Equivalent dynamic load

$$P = Fa + 1.2Fr$$

$$P0 = Fa + 2.7Fr$$

Equivalent static load

$$P0 = Fa + 2.7Fr$$

Applications of these bearings are mainly used in the oil drillers and iron and steel processing machines.

Related bearing code explanation:

- 1, -2... to express one series none standard X1, X2, YA2
- E- internal structure changes, enhanced structure:
- F1- Carbon Steel
- F2- Graphitic steel
- F3- Nodular cast iron
- HC- Ring and rolling elements or only ring or rolling elements are made from case hardened steel (/HC-20Cr2Ni4A; /HC1-20Cr2Mn2MoA; /HC2-15Mn; HC3-G20CrMo).
- /HCOR Indicates the outer ring & rolling element are made by carburized steel.
- J- Pressed steel cage. When material is changed, it is indicated with the added digitals.
- M- Brass solid cage
- P5- Tolerance grade conforms to the standard P5
- P4- Tolerance grade conforms to the standard P4.
- S1- Bearing ring tempered in high temperature, which can reach to 200°C.
- SP- Ultra precision grade, dimension tolerance equals to P5, rotating precision equals to P4.
- TN1- Nylon
- YA3- End face of bearing ring has changed comparing to the standard design.
- YA7- Bearing rib or flange has changed comparing to the standard design
- YA8- Bearing cage structure changed.
- YAB- Structure and technical specification has changed at the same time.
- YAD- One type of bearing has two or more changes on structure.
- YB2- Bearing dimension and tolerance changed.
- YB5- Structure and position tolerance have special requirements.

Thrust Spherical Roller Bearing(Asymmetrical)

d 60-130 mm

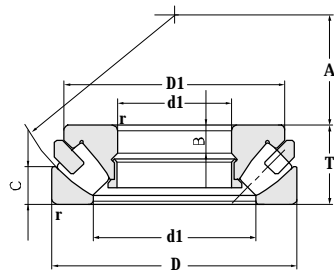

Basic structure

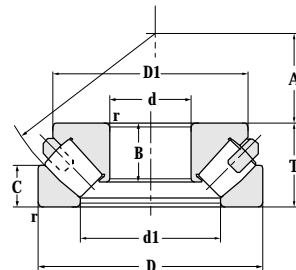

YA7 structure

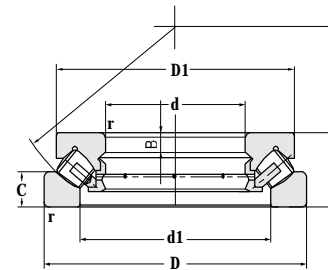

YA8 structure

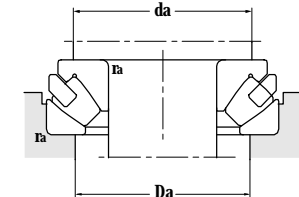

Principal dimensions				Basic load ratings		Limit speed ratings		Designations
d	D	T	r _{min}	C _r	C _{or}	Grease	Oil	
mm				kN		r/min		
60	130	42	1.5	375	880	1800	2600	29412
	130	42	1.5	375	880	1800	2600	29412J
65	140	45	2	440	1040	1700	2400	29413
	140	45	2	440	1040	1700	2400	29413J
	140	45	2	440	1040	1700	2400	29413J1
70	150	48	2	500	1200	1600	2200	29414
75	160	51	2	580	1370	1600	2200	29415
80	170	54	2.1	640	1600	1400	2000	29416
	170	54	2.1	640	1600	1400	2000	29416Q1
	170	54	2.1	640	1570	1400	2000	29416Q1/YA7
85	150	39	1.5	365	1070	1600	2200	29317
90	155	39	1.5	385	1040	1600	2200	29318
	190	60	2.1	785	1980	1300	1800	29418
	190	60	2.1	785	1980	1300	1800	29418Q1
	190	60	2.1	785	1980	1300	1800	29418Q1/HAYA7
	190	60	2.1	785	1980	1300	1800	
100	170	42	1.5	450	1330	1500	2000	29320
110	190	48	2	590	1660	1200	1700	29322
	230	73	3	1130	2880	1100	1600	29422
120	210	54	2.1	545	2010	1100	1600	29324
	250	78	4	910	1590	1000	1500	39424
	250	156	5	980	2700	900	1300	29424D/YA7
130	225	58	2.1	830	2400	1000	1500	29326
	225	116	2.1	830	2400	1000	1500	29326D
	225	58	2.1	830	2400	1100	1600	29326J
	225	58	2.1	830	2400	1100	1600	29326/YA7
	225	58	2.1	830	2400	1000	1500	29326/YA8
	225	58	2.1	830	2400	1000	1500	

Other dimensions					Abutment and fillet dimensions			Weight
d1	D1	B	C	A	d _{amin}	D _{amax}	r _{amax}	
mm					mm			
89	117.6	15	20	38	90	107	1.5	2.60
89	117	15	20	38	90	107	1.5	2.60
95	125	29.5	21	42	100	117	2	3.33
91	120	29.5	22	42	100	117	2	3.14
95	125	29.5	21.5	42	100	117	2	3.34
103	135	31	23	44	107	130	2	4.24
108	140	18	24	47	115	133	2	4.27
113	153.7	19	26.8	50	120	141	2	6.06
113	153.7	19	26.8	50	120	141	2	6.06
114	151	43	25.2	50	120	141	2	9.65
111	138	13	18.7	50	115	129	1.5	2.81
115.5	143.2	13	18.8	52	120	134	1.5	2.93
127	170	22	28.5	56	135	158	2	7.85
127	170	22	28.5	56	135	158	2	7.85
127	170	49.6	28.5	56	135	158	2	7.85
127.5	158.9	14	20.6	58	130	147	1.5	3.80
143	175	16	23	64	145	164	2	6.94
155.5	208	26	34.4	69	164	193	2.5	18.1
156	193.5	18	25.9	70	160	181	2	7.45
172	222	50.5	37	74	180	209	3	17.1
174	220	153	37	74	180	209	3	33.3
168	206.7	19	27.8	76	175	194	2	9.08
168	206.7	19	27.8	76	175	194	2	18.6
166	200	19	28	76	170	195	2	8.48
168	206.7	45	27.8	76	170	195	2	8.99
168	206.7	19	27.8	76	170	195	2	9.11

Thrust Spherical Roller Bearing(Asymmetrical)

d 130~200 mm

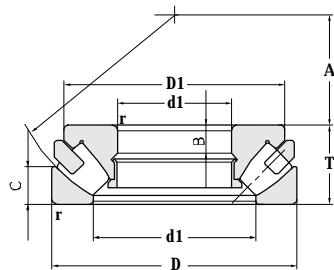

Basic structure

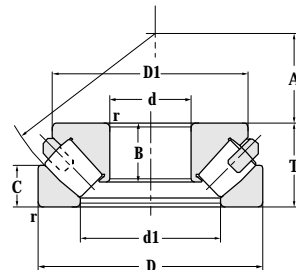

YA7 structure

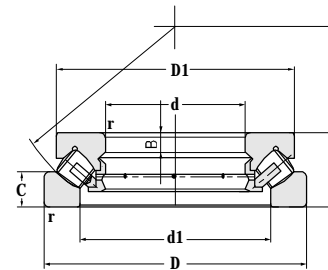

YA8 structure

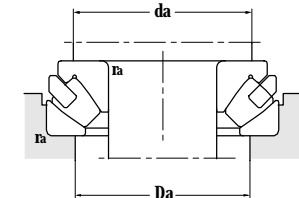

Principal dimensions				Basic load ratings		Limit speed ratings		Designations
d	D	T	r _{min}	C _r	C _{or}	Grease	Oil	
mm				kN		r/min		
130	270	85	4	1500	3890	950	1400	29426/YA7
140	240	60	2.1	940	2600	950	1400	29328
150	250	60	2.1	960	2740	950	1400	29330
	250	60	2.1	960	2740	950	1400	29330A
	250	60	2.1	960	2740	950	1400	29330J
	250	60	2.1	960	2740	950	1400	29330/YA8
	300	90	4	1790	4900	800	1100	29430/YA8
160	270	67	3	1130	3330	850	1200	29332
	270	67	3	1130	3330	850	1200	29332F3
	320	95	5	2000	5330	700	1000	29432
170	280	67	3	1150	3410	850	1200	29334
	280	67	3	1150	3680	850	1200	29334J
	340	103	5	2270	6350	700	950	29434/YA7
180	250	42	1.5	475	1960	900	1300	29236
	300	73	3	1370	4130	700	1000	29336
	300	73	3	1370	4130	700	1000	29336/YA8
	360	109	5	2500	7060	700	950	29436
	360	109	5	2500	7200	700	950	29436/YA7
	360	109	5	2500	7060	700	950	29436/YA8
	190	270	48	2	620	2660	-	1400
270		48	2	620	2660	-	1400	29238F3
320		78	4	1565	4950	750	1000	29338
320		78	4	1565	5300	750	1000	29338/YA8
380		115	5	2740	7680	630	850	29438
200	280	48	2	630	2590	-	1400	29240
	340	85	4	1790	5280	700	950	29340
	340	85	4	1790	5280	700	950	29340J
	340	85	4	1790	5280	700	950	29340/YA8

Other dimensions					Abutment and fillet dimensions			Weight
d1	D1	B	C	A	d _{amin}	D _{amax}	r _{amax}	
mm					mm			
183	246	67.5	39.7	81	142.5	227	3	28.3
183	221	20	28	82	185	208	2	10.1
194	240	20	29	87	195	235	2	11.5
190	215	34.6	29	87	190	210	2	10.5
190	225.5	38	29	87	195	219	2	10.9
194	240	20	29	87	195	219	2	11.5
209.5	273	32	42.1	92	220	253	3	28.6
205	249.6	23	31.7	92	210	235	2.5	14.6
205	249.6	23	31.7	92	210	235	2.5	14.5
218.5	285	34	46.9	99	235	270	4	32.8
216	260.3	23	31.7	96	220	245	2.5	15.7
215	252.5	42.2	32	96	220	245	2.5	14.8
234	310	79	48.8	103	250	286	4	42.8
209	239	15	21.3	97	215	227	1.5	7.05
229	275	25	34.4	103	235	262	2.5	19.9
229	275	25	34.4	103	235	262	2.5	20.3
249.5	326	39	51.2	110	265	304	4	64.2
249.5	326	84	51.2	110	265	304	4	49.8
249.5	326	39	51.2	5	265	304	4	62.5
222.5	257	15.5	24.1	104	225	243	2	8.44
222.5	257	15.5	24.1	104	225	243	2	8.37
240.5	298.3	27	38.6	110	250	280	3	25.1
240.5	308	27	38.6	110	250	280	3	25.7
263	345	41	53.7	117	280	321	4	59.0
234.5	266	15	24	108	240	254	2	8.54
259	314	29	39.1	116	265	297	3	29.5
261	318	54.5	41	116	265	297	3	29.3
261	325	29	41	116	265	297	3	34.0

Thrust Spherical Roller Bearing(Asymmetrical)

d 200~340 mm

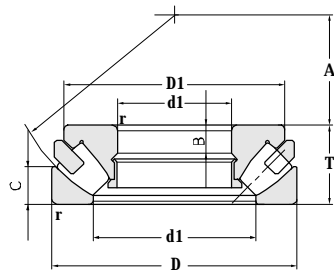

Basic structure

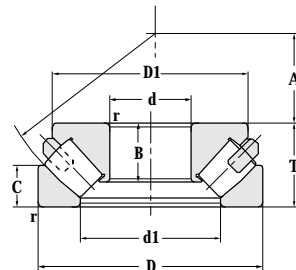

YA7 structure

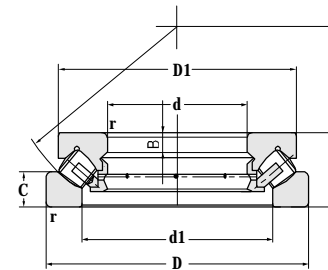

YA8 structure

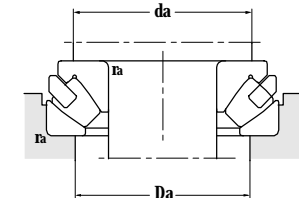

Principal dimensions				Basic load ratings		Limit speed ratings		Designations
d	D	T	r _{min}	C _r	C _{or}	Grease	Oil	
mm				kN		r/min		
200	400	122	5	2480	9100	600	800	29440/YA7
220	300	48	2	665	2780	-	1300	29244
	360	85	4	1920	2800	670	900	29344
	360	85	4	1920	6050	670	900	29344J
	360	85	4	1920	6050	670	900	29344/YA8
	420	122	6	3220	9270	560	750	29444
240	340	60	2.1	910	4360	670	900	29248
	380	85	4	1960	6290	600	800	29348
	380	85	4	1960	6290	600	800	29348/YA7
	380	85	4	1960	6500	600	800	29348/YA8
	440	122	6	3270	10100	530	750	29448
260	360	60	2.1	830	4150	-	1100	29252
	420	95	5	2450	7970	600	800	29352
	480	132	6	3890	12400	500	670	29452J
	480	132	6	3890	13400	500	670	29452J/HC
	480	132	6	3890	12400	500	670	29452J/HC-1
280	380	60	2.1	895	3840	700	1000	29256
	440	95	5	2450	8300	500	670	29356
	520	145	6	4700	14700	480	630	29456
	520	145	6	4700	14700	480	630	29456F1
300	420	73	3	1220	6200	-	900	29260
	480	109	5	2530	10500	700	750	29360
	540	145	6	3500	14800	450	600	29460
320	440	73	3	1320	7050	670	900	29264
	500	109	5	3250	10800	600	800	29364
	500	109	5	3250	10800	600	800	29364/HC
	580	155	7.5	4750	18200	430	560	29464/YA8
340	540	122	5	3150	12400	600	800	29368

Other dimensions					Abutment and fillet dimensions			Weight
d1	D1	B	C	A	damin	Damax	ramax	
mm					mm			
276.5	360	94	56.7	122	295	337	4	85
254	284.4	15	24	117	260	273	2	9.20
277.5	330	29	40.7	125	285	316	3	28.6
273.5	326.3	55	41	125	285	316	3	31
277.5	330	29	40.7	125	285	316	3	29.4
300	381	43	56.9	132	315	358	5	73.2
281	316	19	30	130	290	308	2	15.7
298.5	360	29	41.7	135	305	336	3	35.4
298.5	360	63.5	41.7	135	305	336	3	35.6
298.5	365	29	41.7	135	305	336	3	20.3
316	400	43	60	142	335	378	5	96.1
302	338	19	30	139	310	326	2	16.9
327.5	392.3	32	46	148	335	380	4	50.2
353	446	83	65	154	360	412	5	98.6
342	432	88.2	65	154	360	412	5	101
353	446	83	65	154	360	412	5	98.6
322.5	364	19	29.5	150	325	347	2	21.7
346	411	32	46.3	158	360	400	4	50.6
373.5	470	54	68.9	166	395	446	5	127
373.5	470	54	68.9	166	395	446	5	125
405	353	21	38	162	360	380	2.5	29.5
371.5	448	37	53	168	385	423	4	72.7
395	494.4	52	68.3	175	395	446	5	138
369.5	419.4	21	36	172	375	410	2.5	31.4
394.5	466.5	37	53	180	340	456	4	75.8
394.5	466.5	37	53	180	340	456	4	75.8
420	534	55	75	191	450	500	6	170
421	503	41	59.5	192	440	479	4	101

Thrust Spherical Roller Bearing(Asymmetrical)

d 340~500 mm

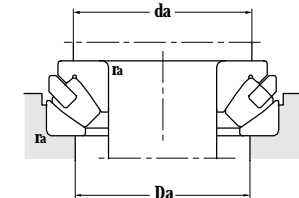
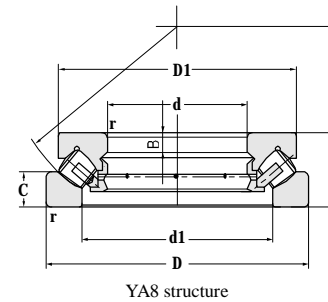
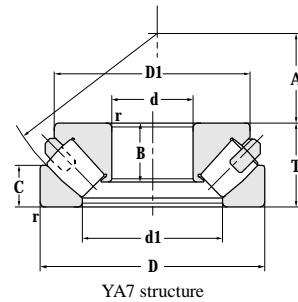
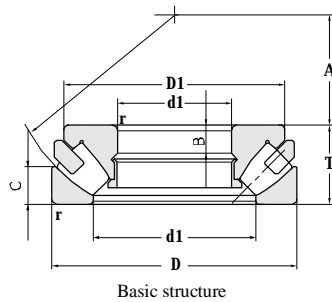

Principal dimensions				Basic load ratings		Limit speed ratings		Designations
d	D	T	r _{min}	C _r	C _{or}	Grease	Oil	
mm				kN		r/min		
340	620	170	7.5	5520	21500	500	700	29468F3 29468/YA57
	620	170	7.5	5700	18500	380	500	
360	500	85	4	1630	8500	600	800	29272 29372 29472/HC
	560	122	5	3080	12400	500	600	
	640	170	7.5	5230	20800	400	500	
380	520	85	4	1820	8900	500	700	29276 29376 29376/HC
	600	132	6	3280	15200	450	650	
	600	132	6	3280	15200	450	650	
400	540	85	4	1720	7680	500	700	29280 29280F3 29280F3/YA7 29380 29380F3 29480
	540	85	4	1720	7680	500	700	
	540	85	4	1650	9050	500	700	
	620	132	6	3500	16800	440	620	
	620	132	6	3500	16800	440	620	
	710	185	7.5	6230	25500	300	450	
420	650	140	6	3800	17900	420	600	29384 29484
	730	185	7.5	6900	28000	400	580	
440	600	95	5	2000	10100	400	580	29288/YA8 29388 29488 29488/HC
	680	145	6	4310	19500	360	480	
	780	206	9.5	7500	30700	260	380	
	780	206	9.5	7500	30700	260	380	
460	620	95	5	2280	12900	400	580	29292 29292/YA8 29392 29392/HC 29392/YA8 29492/YA8
	620	95	5	2280	12900	420	600	
	710	150	6	4460	18800	300	450	
	710	150	6	4460	18800	300	450	
	710	150	6	4460	18800	300	450	
	800	206	9.5	8100	32300	260	380	
480	650	103	5	2350	11800	430	560	29296 29296/YA7
	650	103	5	2260	12700	360	480	
500	750	150	6	4950	23100	280	430	293/500

Other dimensions					Abutment and fillet dimensions			Weight
d1	D1	B	C	A	d _{amin}	D _{amax}	r _{amax}	
mm					mm			kg
449.5	560	61	80	201	475	530	6	218
449.5	560	115	80.1	201	475	530	6	206
420	470	25	41	194	430	453	3	45.9
445	521	41	59.5	202	460	500	4	103
470	588	61	81	210	495	500	6	221
439	498	27	42	202	450	473	3	50
475	561	44	61.4	216	495	535	5	129
475	561	44	61.4	216	495	535	5	129
460	510	27	42	212	470	493	3	64.6
460	510	27	42	212	470	493	3	63.1
460	510	64	42	212	470	493	3	62.9
489	582	44	64.7	225	510	550	5	153
489	582	44	64.7	225	510	550	5	153
529.5	652	67	86	236	550	615	6	309
514.5	610	48	6.8	235	535	580	5	159
545	673	67	89	244	575	635	6	311
508	585	30	46.5	235	520	545	4	77.1
539	636	49	70.8	245	585	630	3	180
583	716	74	97	260	630	695	8	394
583	716	74	97	260	630	695	8	394
525.5	590	30	49.4	245	540	565	4	75.2
525.5	590	30	49.4	245	540	565	4	76.6
567	668	51	72	257	586	630	5	207
567	668	51	72	257	586	630	5	207
567	668	51	72	257	586	630	5	210
596	730	74	99.5	272	630	695	8	415
556	635	33	53.5	259	570	595	4	99.3
554	626	79	51	259	570	595	4	93.4
601.5	709.4	51	75.5	280	630	675	5	221

Thrust Spherical Roller Bearing(Asymmetrical)

d 500~850 mm

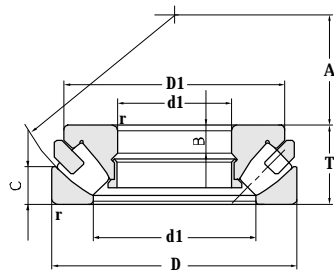

Basic structure

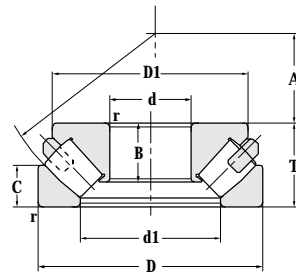

YA7 structure

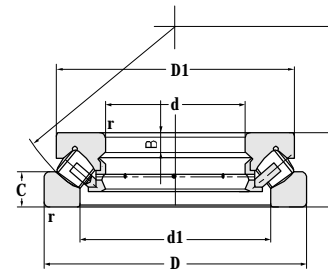

YA8 structure

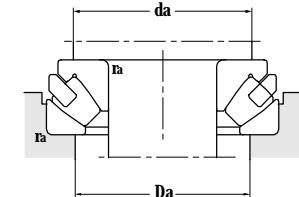

Principal dimensions				Basic load ratings		Limit speed ratings		Designations
d	D	T	r _{min}	C _r	C _{or}	Grease	Oil	
mm				kN		r/min		
500	750	150	6	4950	23100	280	430	293/500/YA3
	750	150	6	4400	21000	280	430	293/500/YB2
	870	224	9.5	9000	39500	320	460	294/500
	870	224	9.5	8900	39500	320	460	294/500/HC
530	710	109	5	5000	16600	350	500	292/530
	920	236	9.5	10000	40500	220	300	294/530
560	750	115	5	3100	15400	360	480	292/560
	750	115	5	3100	15400	360	480	292/560F3
	980	250	12	11500	49000	230	310	294/560
600	800	122	5	4050	21200	360	480	292/600
	900	180	7.5	7000	33500	320	460	293/600F3/HCORYA7S1
	1030	258	12	12500	54000	300	450	294/600
630	1090	280	12	13800	62400	300	450	294/630
	1090	280	12	13800	62400	300	450	294/630/HC
670	900	140	6	4200	22800	260	380	292/670
	1150	290	15	15400	68000	190	240	294/670HC
710	1220	308	15	15600	71000	170	220	294/710
	1220	308	15	15600	71000	170	220	294/710/HC
750	1000	150	6	6100	31000	220	340	292/750
	1120	224	9.5	9370	45000	180	260	293/750
	1280	315	15	18000	81600	140	200	294/750
	1280	315	15	18000	81600	140	200	294/750F3
800	1060	155	7.5	6220	36000	240	340	292/800
	1360	335	15	19400	89300	230	310	294/800F3
850	1440	354	15	28600	100000	120	150	294/850F1
	1440	354	15	28600	100000	120	150	294/850F1/HC

Other dimensions					Abutment and fillet dimensions			Weight
d1	D1	B	C	A	d _{amin}	D _{amax}	r _{amax}	
mm					mm			
601.5	709.4	51	75.5	280	630	675	5	221
595	675	51	63	280	630	675	5	201
648	790	81	106	290	685	755	8	589
648	790	81	106	290	685	755	8	589
604	680	35	54	288	615	655	4	118
686	845	89	114	309	725	800	8	615
640	715	40	56.8	302	655	685	4	131
640	715	40	56.8	302	655	685	4	131
727	890	92	120	328	770	850	10	741
688	760	39	59.4	321	700	735	4	159
726	841.5	132.5	87	335	755	810	6	373
769	940	92	127	347	815	900	10	839
816	995	100	137.5	365	860	950	10	1005
816	995	100	137.5	365	860	950	10	1005
773	880	45	73	365	790	825	5	225
864	1045	110	141	387	905	1000	12	1170
910	1130	113	148.5	415	965	1070	12	1406
910	1130	113	148.5	415	965	1070	12	1406
858	950	50	74	406	880	925	5	296
910	1086	76	108	415	935	1000	8	703
972	1164	116	158	436	1015	1120	12	1530
972	1164	116	158	436	1015	1120	12	1530
907.5	1010	50	80	426	935	980	6	343
1034	1250	120	165	462	1080	1185	12	1826
1098	1330	221	172	494	1080	1230	12	2090
1098	1330	221	172	494	1080	1230	12	2090

Thrust Spherical Roller Bearing(Asymmetrical)

d 900~1620 mm

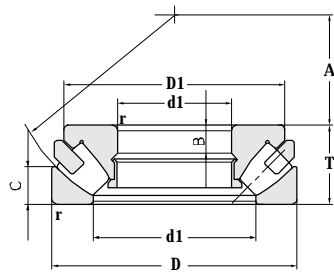

Basic structure

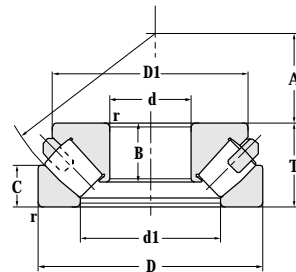

YA7 structure

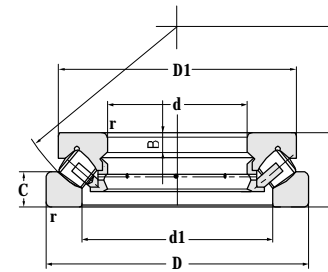

YA8 structure

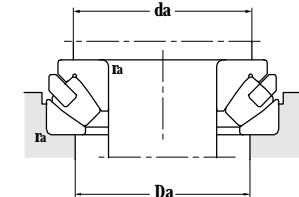

Principal dimensions				Basic load ratings		Limit speed ratings		Designations
d	D	T	r _{min}	C _r	C _{or}	Grease	Oil	
mm				kN		r/min		
900	1180	170	7.5	7550	41500	120	150	292/900 294/900F3/HCYA8
	1520	372	15	26400	121000	120	150	
950	1250	180	7.5	8430	46900	190	240	292/950 294/950F1/HC
	1600	390	15	27100	127000	170	220	
1060	1400	206	9.5	10500	62000	180	260	292/1060 292/1060F3 294/1060F3/HCSYA8
	1400	206	9.5	10500	62000	180	260	
	1770	426	15	32100	150000	150	200	
1120	1460	206	9.5	11000	68600	170	220	292/1120F1 292/1120F3
	1460	206	9.5	11000	68600	170	220	
1180	1520	206	9.5	10900	64000	170	220	292/1180
1320	1540	175	6	6500	48500	120	150	217/1320
1620	1860	150	6	6490	48600	120	150	292/1620/YAD

Other dimensions					Abutment and fillet dimensions			Weight
d1	D1	B	C	A	d _{amin}	D _{amax}	r _{amax}	
mm					mm			kg
1023	1125	54	86	477	1030	1080	6	445
1137	1394	244.5	186	518	1160	1370	12	2653
1081	1185	58	88	507	1095	1155	6	537
1209	1470	253	191	546	1275	1400	12	2920
1208	1335	66	100	566	1225	1290	8	767
1208	1335	66	100	566	1225	1290	8	767
1332	1640	192	207	610	1410	1555	12	4040
1272	1385	141.5	101	601	1300	1365	8	804
1272	1385	141.5	101	601	1300	1365	8	804
1331	1450	83	101	625	1345	1410	8	854
1380	1510	72	98	1446	1470	1400	5	514
1722	1799	103	78.5	850	1780	1720	5	548

Thrust Spherical Roller Bearing(Symmetrical)

d 70–260 mm

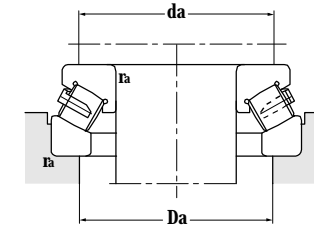
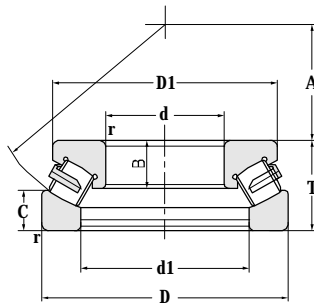

Principal dimensions				Basic load ratings		Limit speed ratings		Designations
d	D	T	r _{min}	C _r	C _{or}	Grease	Oil	
mm				kN		r/min		
70	150	48	2.3	314	430	1400	2000	29414/YAD
80	170	54	2.5	407	550	1100	1700	29416/YAD
90	190	60	2.5	484	690	950	1500	29418/YAD
100	210	67	3	644	865	850	1300	29420/YAD
110	190	48	2	400	1270	1300	1800	29322/YAD
120	210	54	2.5	418	650	1000	1600	29324/YAD
	250	78	3.7	781	1060	750	1100	29424/YAD
	250	78	3.7	781	1060	750	1100	29424/YAD-1
130	225	58	2.5	484	750	950	1500	29326/YAD
	270	85	3.7	836	1100	700	1100	29426/YAD
140	280	85	3.7	908	1120	670	950	29428/YAD
150	300	90	3.7	1090	1710	630	900	29430/YAD
160	270	67	3	730	2380	630	900	29332/YAD
	320	95	4.7	1100	1720	560	800	29432/YAD
170	340	103	4.7	1330	2130	530	750	29434/YAD
180	300	73	3	974	3000	630	900	29336/YAD
	360	109	4.7	1330	2130	750	750	29436/YAD
220	300	48	2	484	910	850	1300	29244/YAD
240	440	122	6	2420	8000	530	750	29448A
	440	122	6	1920	3550	530	750	29448/YAD
260	360	60	2.1	798	1550	530	750	29252/YAD
	480	132	6	3200	11000	530	750	29452A

Other dimensions					Abutment and fillet dimensions			Weight
d1	D1	B	C	A	damin	Damax	ramax	
mm					mm			
103	135	31	23	44	105	125	2	3.87
117	155	35	25	50	120	141	2	5.33
132	170	39	29	56	135	158	2	7.13
146	190	45	32	62	150	175	2.5	10.5
140	175	31	24	64	145	164	2	5.08
161	188	34	30	57	160	181	2	6.88
	181	222	48	38	74	180	3	19.5
	181	222	48	38	74	180	2	19.4
170	200	37	29	76	175	194	2	8.26
190	240	55	44	79	195	227	3	23.0
203	247	55	47	64	205	236	3	22.7
220	270	60	48	69	220	253	3	27.3
200	240	45	32	92	205	235	2	13.5
	234	275	61	53	74	235	4	33.3
243	310	71	48	104	250	286	2	40.7
230	276	50	35	103	235	262	2.5	19.4
	265	308	67	58	82	265	2	42.3
260	286	31	24	117	260	273	5	7.92
328	370	65	59	142	335	378	5	72.7
	330	400	78	59	142	335	5	74.5
302	335	38	30	139	310	326	2	15.7
	343	400	76	65	154	310	5	95.3

Thrust Spherical Roller Bearing(Symmetrical)

d 280~1320 mm

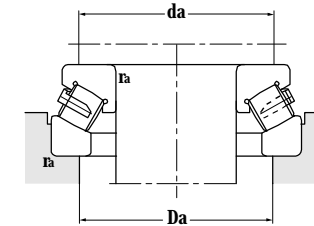
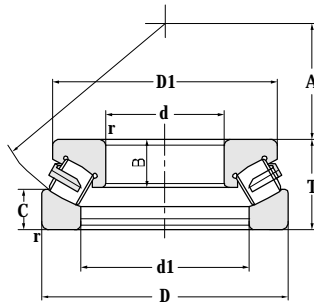

Principal dimensions				Basic load ratings		Limit speed ratings		Designations
d	D	T	r _{min}	C _r	C _{or}	Grease	Oil	
mm				kN		r/min		
280	440	95	5	1600	6060	530	750	29356/YAD 9069356
	440	95	5	1450	6060	530	750	
340	460	73	3	1250	2440	530	750	29268/YAD 29468A
	620	170	7.5	5050	19000	500	690	
380	600	132	6	3750	15200	500	690	29376/P5YAD
420	580	95	4.7	2060	4150	460	560	29284/YAD
440	780	206	9.5	7150	26000	400	450	29488A
490	655	90	5	2300	12000	400	450	217/490/YAD
500	870	224	9.5	6930	27700	260	340	294/500/YAD
590	755	95	5	2390	13200	260	340	217/590/YAD
630	850	132	6	3580	8350	250	300	292/630F3/YAD
670	900	140	6	3900	20300	200	240	292/670F3/YAD
710	950	145	6	3960	12000	200	240	292/710/YAD
750	1280	315	15	14850	31000	80	100	294/750F1/YAD 294/750F3/YAD
	1280	315	15	14850	31000	80	100	
1320	1540	175	6	6500	48500	60	80	217/1320

Other dimensions					Abutment and fillet dimensions			Weight
d1	D1	B	C	A	d _{amin}	D _{amax}	r _{amax}	
mm					mm			
348	413	64	46	158	355	390	4	49.1
348	413	64	46	158	355	390	4	49.1
388	438	48	36	204	400	422	2.5	31.4
450	520	102	77	201	440	500	6	197
475	561	106.5	61.4	216	480	550	5	131
489	548	62	46	251	500	525	4	78.9
583	650	115	96.5	260	550	630	8	355
552	627	52	40	482	615	635	4	73.7
654	760	140	108	290	685	755	8	462
654	727	55	41.5	570	715	735	4	90
728	800	86	65	338	740	780	5	231
750	830	86	70	365	760	820	5	210
805	895	92	75	380	820	880	5	279
972	1152	160	158	448	1015	1120	12	1340
972	1152	160	158	448	1015	1120	12	1340
1380	1510	98	72	1446	1495	1515	5	514

Railway Bearing

1. Railway Bearing Application

The bearing applied for railway industry must possess high load carrying capacity and safety performance, Wafangdian Bearing Group Corp.,Ltd. have professional experience in the railway bearing application for more than 60 years providing professional technical supporting comprehensive and high quality products. ZWZ Group is the most important railway bearing manufacturer in China, also is the only enterprise that can manufacture railway locomotive, passenger car, wheel bearing journal box free type bearing for railway wagon, during the process of close cooperation with Ministry of Railways and manufacturer of locomotive vehicle, we design the best allocation plan for each type of bearings' application. Our products include journal box bearings for railway passenger car, railway wagon wheel bearing journal box free bearings, locomotive journal box bearing, main generator bearing, traction motor bearing, axle gearbox bearing, traction motor journal sticking bearing, wheel set hollow shaft drive bearing (full suspended bearing) and etc. Subway, light railway, rural railway as one important component of the city public transport system, are known as "major arteries of urban passenger traffic", since entered the 21st century, along with the rapid growth of the economy and the progress of urbanization in China, urban railway system also enter into a fast growing period, China have already become the world's biggest urban railway transit market, and urban railway vehicle bearing gradually changed from depending on imported bearing to localization. ZWZ Group rely on abundant R&D technology, advanced production techniques & equipments and

perfect service system, successfully complete the research and development of the rail transit bearings, supporting several rail transit vehicle in different major cities in China, the major products include each kind of subway journal box bearing, light rail journal box bearing, journal box bearing for low floor vehicle and subway gearbox bearings.

2. Wheel Bearing

Railway locomotive vehicle wheel bearings adopt different structure designs due to different application conditions, locomotive and passenger vehicle have journal box, bearing is connected with bogie through journal box, railway wagon is journal box free, bearing is connected with side bogie through adapter. Bearing carry the impact load between wheel bearing and bogie structure, and also need to carry the axle load while the vehicle turns. Wheel bearing structure includes cylindrical roller bearing, cylindrical roller bearing unit, tapered roller bearing, tapered roller bearing unit. According to the application requirement to the railway bearing, wheel bearing shall have long-term period of free maintaining period, structure design for easier maintaining, and high reliability.

2.1 Classification and Application of Wheel Bearings

The railway vehicle wheel bearing can be divided into following types, according to the design technology and applications of vehicle types:

- Cylindrical roller bearing unit
- Double-row tapered roller bearing unit
- Single-row tapered roller bearing
- Single-row cylindrical roller bearing

2.2 Cylindrical Roller Bearing Unit

Cylindrical roller bearing unit mainly is applied to railway locomotive, passenger vehicle, urban railway transit vehicle journal box, generally, the double-row cylindrical roller bearing with sealing devices on both sides of bearings, or one pair matched single-row cylindrical roller bearing with single side sealing device. Bearing units have been already filled with lubricating grease before mounting, free of filling lubricating grease while mounting. Because bearings have integrated sealing devices,

making the bearing with long period free of maintaining. This type of bearing have special internal structure designs, the modified liner contact between roller and raceway reduce the edge stress and can make the bearing especially fit for carrying very high level of radial load, also can carry part of axle load at the same time. Compared with tapered roller bearing unit, cylindrical roller bearing unit is easy for mounting and assembling, convenient for bearing's repair and maintenance.

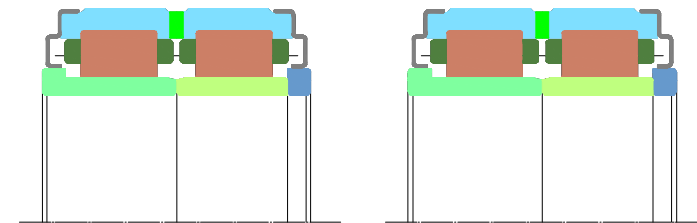

Double-row Cylindrical Roller Bearing Unit

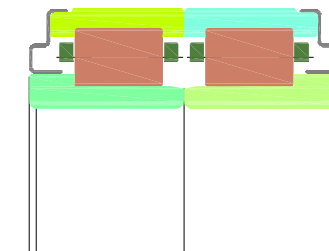

Paired Single-row Cylindrical Roller Bearing Unit

2.3 Double-row Tapered Roller Bearing Unit

Bearing units have complete sealing, filled with lubricating grease and adjusted clearance before mounting, integrated unit design is good for bearing's mounting and dismounting,

bearing mounting onto the journal by cold press method. Bearing internal adopt ECP structure design, optimized inner ring flange and roller reference plane, decrease bearing

Railway Bearing

sliding friction and temperature rise, at the same time adopt modified contact design between roller tessellation lines and raceway to avoid edge stress, which can guarantee the bearing is especially fit for carrying the combination load of radial and axle load. Through the calculation FEM and comprehensive performance testing, make sure of the optimized design of bearing structure. The FEM method not only can describe the magnitude of stress level, but also can actually reflect the stress gradient distribution of the bearings.

In order to lower the bending deformation to the shaft while carrying heavy load, adopt compact design for heavy load railway bearings, shorten the distance to journal

Good sealing devices can effectively prevent the leak of lubricating grease, prevent the foreign matter and water invading into the bearing, which can effectively reduce the failure in application, prolong the maintaining period, and guarantee the bearing with long service life. The labyrinth sealing structure performs better than traditional contact sealing in the aspect of sealing performance, lower temperature rise, but due to large axle load,

shoulder, improve the rigidity of shaft, decrease the micro abrasive of bearing, decrease the failure in actual application and improve bearing's service life.

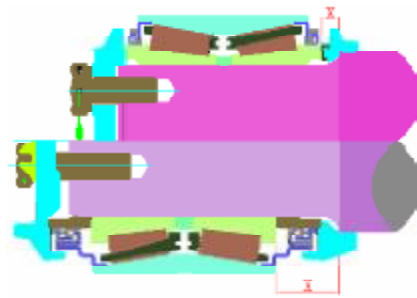

Comparison of compact structure design and traditional design

not good for decreasing micro abrasion effect to the bearings; Composite sealing is integrated structure design, benefit for mounting and dismounting, and can shorten the bearing axial width, fit for the compact structure design with better sealing performance, have the characteristic low friction torque, low running temperature rise, generally apply to heavy load railway wagon bearing and urban rail transit journal box bearing and etc.



Contact Type Sealing

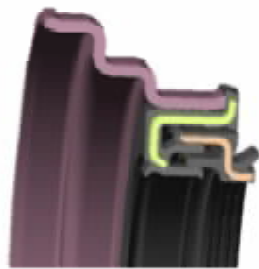

Labyrinth Sealing

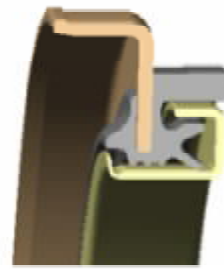

Composite Sealing

2.4 Single-row Tapered Roller Bearing

This series bearing are generally applied to the low speed railway vehicle with urban low floor, because of the limit of the structure of trailer bogie, need low floor type special axle instead of normal journal wheel and axle, the bearing mounting in the wheel set, bearing inner ring fit with special shaft, outer ring fit with wheel set, the wheel set is considered as journal box, bearing outer ring rotating, this application was called "Embedded wheel hub bearing unit". The ZWZ embedded wheel hub bearing unit which is mounted on independent wheel set in the light rail low floor vehicle is combined with one pair of tapered roller bearing, these two bearings adopt high precision manufacturing technique, to guarantee the bearing with high mounting precision and rotating performance. Select proper matching clearance, make the wheel set have relative high rigidity and guarantee the stability when the vehicle running.

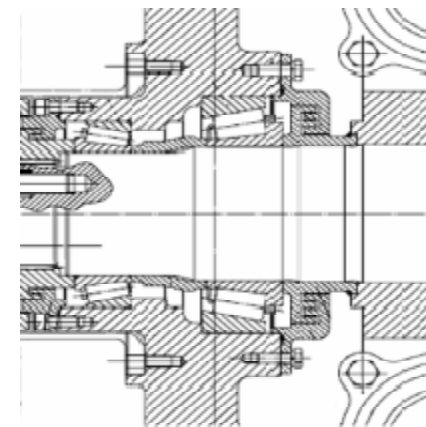

Embedded Journal Box Bearing

2.5 Single-row Cylindrical Roller Bearing

Cylindrical roller bearing is one of the most widely adopted bearing type, already passed the verifications on each kind of application in different kinds of railway vehicle, which are applied to the journal box in railway locomotive, passenger car and light rail vehicles, this type of bearings are generally applied in pairs with NJ/NJP type bearings, fit for carrying very high level radial load and amount of axial load. Bearings have special internal structure design, rolling element and raceway modification design, avoiding edge stress to guarantee the bearing with high load carrying capacity and adopt plastic-steel cage to benefit bearing high speed rotation.

3. Transmission and driving system bearing

3.1 axle gearbox bearing

The main function of rolling bearing in gearbox is mainly for output stable torque while the locomotive running at high speed, it means they must carry varying impact load under complicate environment. The type of bearings are mainly tapered roller bearing, four-point contact bearing and cylindrical roller bearing. The collocation of bearing varying in different types, mainly depend on gearbox design and working condition.

The main application performance of gearbox bearings are:

- High speed
- High Load Carrying
- Vibration and impact resistance
- High temperature resistance

The bearing selection and confirmation is determined by related structure dimension of

Railway Bearing

gearbox , meanwhile shall consider elements of application above, generally it requires the calculated service life is over two million kilometers.

Besides the locomotive gearbox bearing made by ZWZ Group adopt special structure designs, in addition, improve cage strength through increasing the thickness pocket bar of the brass cage and conducting special surface treatment

of pressed sheet-steel cage, in order to fulfill the effect of the impact caused by locomotive vehicle running in high speed. The main structural characteristics of the bearing are:

- Enhance internal design, improve bearing's load carrying capacity;
- Adopt high strength high quality copper alloy material, optimize cage structure design, to guarantee bearing rotating reliability;

improve bearing's design and manufacturing quality and ensure the bearing can satisfy the complicate working condition application and strict working requirement of the traction motor. The traction motor bearings always adopt Cylindrical roller bearing and Deep groove ball bearing, also part of traction motor's designs adopt Spherical roller bearing. The calculation life of the bearing is more than two million kilometers.

bogie frame, the weight of traction motor totally equals to the weight above the spring, reduced the weight below the spring, so that the wheeltrack vertical dynamic load is relatively small. The vertical and horizontal acceleration caused by wheeltrack impact on the rail where it is not smooth can not be delivered to the traction motor and traction gear unit pairs directly. The working condition of traction motor and traction gear pair is improved significantly, the failure rate decreases, service life extended and benefit the locomotive run at a high speed.

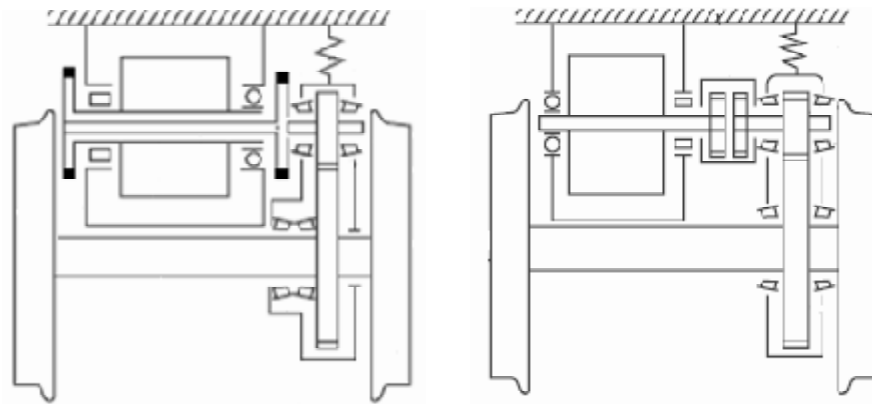

Railway Locomotive Transmission And Driving System

3.3 Axle box bearing

The two axle box bearings are mounted in the axle box applied to the locomotive vehicle with the structure of suspension type eclectic traction motor, to support the traction motor horizontal configured. Traction motor normally is supported on the bogie frame, the other side is supported on the axle through axle box bearing. In order to make the axle box bearing with high reliability and realize long operating life (in normal condition the operating condition shall be over 2 million km), the bearing applied in this position shall have high load carrying capacity. The high load caused by vibration and impact normally carried by the special tapered roller bearing with enhanced pressed metal cage.

3.5 Transmission and Driving System Bearing Application Features

3.5.1 Tapered Roller Bearing

Tapered roller bearing is separable, the cone assembly and cup can be separate and assembled independently. The modified liner contact of the rolling element and raceway avoid edge stress. Tapered roller bearing can carry high level axial and radial load. Because this type of bearing can carry the axial force in only one direction, so it should be applied in pairs. This type of bearings are applied in the gearbox and axle box.

3.5.2 Four-point Contact Bearing

Four-point contact ball bearing is a kind of angular contact ball bearing. This type of bearing can carry axial load in double directions, generally together with cylindrical roller bearing which carry radial load, and adopt clearance fit in radial direction. The structure of inner ring is split type that can make bearing installed much more steel balls. This type of bearings are applied to gearbox.

3.5.3 Cylindrical Roller Bearing

Single-row cylindrical roller bearing due to

3.4 Wheel Set hollow Axle Bearing(full suspension bearing)

This type of bearing is applied to wheel set hollow axle driving devices. The bearing for gear wheel is supported on the hollow axle sleeve which was fastened on the body of the traction motor and the bearing outer ring rotates. Wheel set hollow axle driving device is widely applied to the locomotive and bullet trains with high speed, the main characteristic is that the traction motor is fastened on the

3.2 Traction Motor Bearing

Traction motor is the key equipment in the locomotive transmission system, bearing is the critical component of traction motor, besides the bearing carrying the weight of rotor, it also need to bear the traction force and break force effects caused by frequent starting and break, meanwhile, it need to carry the impact load during running of the locomotive and the force generated by gear engagement. As a result, under such complicate working conditions, bearing must satisfy high

running operating reliability and long service life requirement, so this makes greater requirements for bearing's design and manufacturing quality. The traction motor bearings developed by ZWZ Group are all conducted optimized designs depending on the actual demand of customer, through proper selection of clearance, optimized structure of cage, the advanced methods of ring and rolling element heat treatment processing technique, enhanced internal structure optimization, they

Railway Bearing

the inner ring can be separated from the assembly made up of outer ring, roller and cage, extremely beneficial to bearing's mounting, dismounting, maintaining and inspection, therefore they are applied more widely than other types of bearing in railway bearing. Cylindrical roller bearing can carry high level of radial load, the modified liner contact of the rolling element and raceway can avoid edge stress and improve the reliability of the bearing in application. The combination of NJ and NUP type cylindrical roller bearing can carry amount of axial load. This type of bearing can be applied to traction motor, gearbox and wheel set hollow axle driving devices.

3.5.4 Insulated Bearing

Under some special or poor working conditions, journal box bearing and electronic motors can be damaged caused by additional voltage. Even the process technique of the electric motor is complete, it can not completely avoid the electric potential difference between the rotor and stator caused by electromagnetic asymmetry, so it formed closed circuit while the current went through the bearing. In order to avoid the circumstance above, the solution of ZWZ group, is to adopt bearing ceramic coating on the bearing outer ring surface, to blocking-up the voltage not lower than 1000V, to protect bearing not to suffer the electric corrosion failure due to extra voltage.

4. Bearing Fit

4.1 The Purpose of Fit

The purpose of fit is to let the bearing inner ring or outer ring tight fastened on the shaft

or housing, in order to avoid the disadvantageous relative sliding between the fitting surface. This type of disadvantageous relative sliding "called creep" can raise bearing's abnormal temperature rise, creeping abrasive in fitting surface (and then let the abrasive iron powder invade into the internal of bearings) and abnormal vibration and other operating failure. Hence, for the bearing, due to the rotation which carrying load, must let ring interference and let it strongly fasten with shaft or housing.

4.1.1 Dimensional Tolerance and Fit of The Shaft and Housing

Shaft and housing dimensional tolerance have already been standardized by GB/T275-93 "Fit of Rolling Bering with Shaft and Housing", select the dimensional tolerance inside so it can access and determine the fit between bearing and shaft or housing. For the specially required fit, it can be chosen from the agreement document provided by customers.

4.1.2 Selection of Fit

According to the load direction applied to the bearing, property and whether inner ring or outer ring rotating, the load can be divided into rotation load, static load or no directional load. The ring carrying rotation load and no directional load shall select interference fit, the ring carrying static load shall select clearance fit.

While bearing load is high or carrying vibration or impact load, the interference shall increase. While adopting hollow shaft or the bearing housing with thin wall or light alloy gearbox, it also shall increase interference. The selection of interference of the bearing can be calculated according to the methods as below:

(1) The effect of the magnitude of load
The inner ring under the radial load, initial interference shall be decreased. The decrease amount of interference can be calculated by the formula as below.

[Fr ≤ 0.25 Cor]

$$\Delta dF = 0.08 \sqrt{\frac{d}{B}} \cdot Fr \times 10^{-3}$$

[Fr > 0.25 Cor]

$$\Delta dF = 0.02 \frac{Fr}{B} \times 10^{-3}$$

ΔdF: the decrease amount of the inner ring interference

d: nominal bore diameter of bearing

B: nominal width of bearing inner ring

Fr: Radial load, N {kgf}

Cor: Basic rating static load, N {kgf}

(2) The effect of the roughness of the fitting surface

If considering the plastic deformation of salient point of the fitting surface, then the effective interference after fitting can be affected by the manufacturing precision to the fitting surface

[Grinded shaft]

$$\Delta d_{eff} = \frac{d}{d+2} \Delta d$$

[Turned shaft]

$$\Delta d_{eff} = \frac{d}{d+3} \Delta d$$

Δd_{eff}: effective interference, mm

Δd: actual interface, mm

d: bearing nominal bore diameter, mm

(3) Influence of temperature

In general, while in operation, the temperature of the bearing is higher than that of the components around, hence the inner ring temperature is higher than shaft temperature and the thermal expansion make the effective interference small.

The decrease amount of the interference due to the temperature difference can be calculated by formula as below.

$$\Delta dt = 0.0015 \Delta t \cdot x \cdot 10^{-3}$$

Besides, between the outer ring and housing, because of the temperature difference or the difference expansion factor, in return, the interference will be increased. So while choosing the fit between outer ring and housing, it need to consider the influence by the temperature.

(4) Minimum interface of bearing fitting

Comprehensively considered the magnitude of load, accuracy of fit and the influence by the temperature for bearings, the minimum interference of baring fit can be calculated according to the formula as below.

Fr ≤ 0.25 Cor While

$$\Delta d_{eff} = \frac{d+2}{d} \left(0.08x \sqrt{Fr \cdot \frac{d}{B}} + 0.0015x \Delta T x d \right)$$

Fr > 0.25 Cor While

$$\Delta d_{eff} = \frac{d+2}{d} \left(0.02x \sqrt{Fr \cdot \frac{d}{B}} + 0.0015x \Delta T x d \right)$$

(5) Others

For the extremely high requirements for the fit accuracy or applied to the working condition

Railway Bearing

with high rotation precision, high precision bearings shall be chosen, and improve the manufacturing precision of shaft and housing. Compared with shaft, the housing manufacturing is hard and the manufacturing precision is low, so that the fit between outer ring and housing can be relaxed appropriately. None-separable bearing (such as deep groove ball bearing) inner and outer ring all choose interference fit, but it is extremely not convenient for the mounting and dismounting the bearing, so based on the application of working condition, make one inner ring or outer ring adopt clearance fit.

5. Lubrication

Precondition for ensuring bearings long service life is clean working environment and good lubricating condition. As a result, good lubrication plays important role in improving bearing load capacity and service life.

5.1 Lubrication Effect

- Reduce the friction between the metal and slow wear;
- The formation of the oil film increase the contact area and reduce the contact stress;
- Make sure roller bearing can run for long time and prolong fatigue life under high frequent contact stress;
- Reduce friction heat, lower working temperature of bearing surface and avoid burning;
- Have anti-rust and anticorrosion effect.

5.2 Oil Lubrication

Oil lubrication is mainly used in gearbox bearing. The form of lubrication is splash lubrication and it is a common lubrication

method applied in closed gear transmission device. Use gears to splash the oil on the bearing or flow into the predesigned oil tank along the box wall, then enter the roller bearing inside. For roller bearing lubrication, the used oil can be collected again in the box for recycling use. Because when roller bearings use splash lubrication, there is no auxiliary facilities, so it is often adopted by gear transmission device with simple and tight structure. But pay attention to 3 points as below when adopting splash lubrication:

(1) Lubrication oil surface can not be too high, or oil stirring loss will be too much. Meanwhile, sediment such as abrasive dust in the oil pool will be taken into bearing position and cause abrasive wear.

(2) Lubrication oil in the box should be kept clean, use magnetic adsorber in the oil pool to clean abrasive dust and foreign matter timely to Reduce the occurrence of abrasive wear.

(3) When designing structure, set a oil cistern on the box wall and an orifice leading into bearing to make bearings stay oil bath lubrication and drop lubrication state, as well as supplement lubrication and avoid insufficient oil supply.

5.3 Grease Lubrication

Grease lubrication is mainly applied in railway vehicles and can be used in axle box bearing, self-sealed bearing unit, traction motor bearing, axle hung bearing, full hanger bearing and so on. Normal rules on lubrication selection are as below:

(1) Working Temperature

The working temperature affects the viscosity variation and lubrication effect of the lubrication grease. So when the working temperature is low, the grease with low

viscosity should be adopted; When the working temperature is high, the grease with high viscosity or with certain additive should be adopted. When the working temperature changes frequently, adopt grease with good viscosity-temperature characteristics whose viscosity will not change a lot as the working temperature increases or decreases, in order to ensure lubrication film thickness is controlled in a certain range.

(2) Working Speed

The higher rotation speed, the grease with lower viscosity should be used to avoid motion resistance increasing and generating too much heat; on the contrary, adopt grease with high viscosity when the rotation speed is low to enhance load capacity.

(3) Transport Property

The transport contains impact, vibration, frequent variable load, speed change and start. Parking, frequent inversion and round trip or intermittent movement are not good for forming oil film, so the grease with high viscosity should be applied.

(4) Working Load

The greater the load, the higher viscosity grease should be selected as well as with good EP properties, in order to avoid the grease squeezing out of the friction pair when with the high load and generate dry friction from direct contact between metal.

(5) Structure Characteristics

The smaller clearance of roller bearing, the higher working precision of the friction surface and the lower viscosity grease will be.

(6) Environment Condition

When the bearing works in the humid condition with corrosive gas, low temperature and dust, the grease is easy to be tainted, in this situation,

should use the grease that is water-resistant, wear-resistant, corrode-resistant and cold-resistant.

(7) Bearing Precision

When the bearing movement friction surface is rough, it is common to use grease with high viscosity, in order to withstand big local stress caused by bad contact. When the precision of movement friction surface is high, the grease with low viscosity should be applied, so that the unnecessary energy losses and temperature rise can be reduced.

5.4 Wheel Bearing

Railway wheel bearings often use special lubrication grease regulated by Ministry of Railways. These grease has been passed the test by using in railway vehicles and can satisfy the working condition of railway vehicles. For the bearings used in metro and light rail vehicles, the general recommendation is to use the grease specified by Ministry of Railways, such as railway*type grease, railway *type grease and locomotive wheel set lubrication grease, etc. Besides, it is also advised to use Mobil SHC series grease and Shell railway bearing grease, etc. For the grease of other bearing positions, it can select as customer's request or choose the proper grease according to the choice principle of the grease above.

6. Bearing Clearance

Theoretical clearance minus swelling or contraction amount caused by interference fit when mounting the bearing to the shaft or housing, the result of this clearance is called "mounting clearance". On the basis of mounting clearance, add or subtract the size change quantity caused by internal temperature

Railway Bearing

difference, the result of clearance is called "effective clearance". When the bearing is mounted in the machines rotating with a certain loads, the clearance resulted from adding amount of elastic deformation to the effect clearance is called "working clearance". When the working clearance value is micro negative,

the bearing fatigue life is the longest, but with the negative clearance increases, the fatigue life decreases significantly. As a result, when choosing the bearing clearance, it is common to make the clearance zero or slightly positive for good.

Relationship between working clearance and fatigue life is shown as below (10⁴ km/10μm)

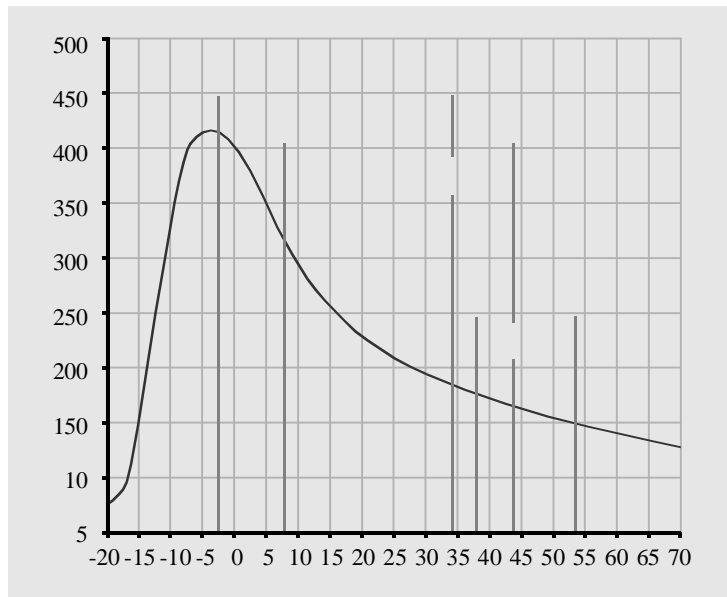

Bearing Life and Clearance Curve

7. Bearing Life

When the bearing is rotating with load, as alternating load continuously have effect on the ring raceway and rolling surface of rolling element, even under the conditions of normal use, there is still fish scale damage (also called stripping or peeling) on the raceway surface and rolling surface because of material fatigue.

The total number of rotating before these rolling fatigue damage happened is called "(fatigue)" life. Even bearings with the same structure, dimension, material and manufacturing method, under the same rotating condition, the bearing (fatigue) life still has large difference. This is because the material

fatigue itself is dispersed and should be considered from the perspective of statistics. Then when the same batch bearings rotate under the same condition, the total number of rotating that 90% of the bearings without rolling fatigue damage is called "bearing basic rating life" (means reliability is 90% of life). When the rotation speed is fixed, it is also can be shown as total rotation time. But in the actual work, there are also other damages besides rolling fatigue damage. These damages can be avoided through reasonable bearing selection, mounting and lubricating, etc.

7.1 Basic Dynamic Load Rating

The basic rating dynamic load shows ability of bearing rolling fatigue resistance (means

load capacity), it is the pure radial load with rating size and direction, under the condition of inner ring rotating and outer ring fixed, the basic rating life can achieve one million revolutions. The basic rating dynamic load of radial bearing and thrust bearing are respectively called radial basic rating dynamic load and axial basic rating dynamic load, expressed as Cr and Ca and their values are listed in the bearing dimension table.

7.2 Basic Rating Life

Formula (1) Calculation formula of bearing basic rating life;

Formula (2) Life formula shown by time when the bearing rotation speed is fixed.

$$\text{(Total rotations)} \quad L_{10} = \left(\frac{C}{P} \right)^P \quad \dots\dots\dots (1)$$

$$\text{(Time)} \quad L_{10h} = \frac{10^6}{60n} \left(\frac{C}{P} \right)^P \quad \dots\dots\dots (2)$$

- L10: Basic rating life, 10⁶ rotates
- L10h: basic rating life, h
- P: Equivalent Dynamic Load, N {kgf}
- C: Basic static load rating N {kgf}
- N: rotation speed, rpm
- P: life factors
 - Ball bearing P=3
 - Roller bearing P= 10/3

7.3 Dimension Stabilizing Treatment of Bearing

As the temperature of railway locomotive transmission and driving series bearings is

high, the organization of bearing component material will change, the hardness will be reduced and the bearing service life will be shorter than that used in normal temperature.

Railway Bearing

When the material organization changes, bearings will not recover even the temperature changes to normal. So when the temperature of railway locomotive transmission and driving series bearings is more than 100 °C, the bearings must be acted dimension stabilizing treatment.

Refer dimension stabilizing treatment specification as below:

Dimension Stability Treatment Code	Operating Temperature Range
S0	Over100°C to150°C
S1	Over150°C to200°C
S2	Over200°C to250°C

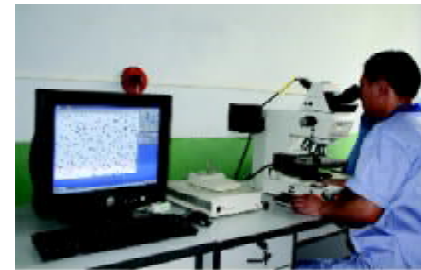

8. Bearing Reliability Test

Assembled bearing and every component material performance can all be tested in the inspection

& test center of ZWZ. Through more than 200 different kinds of inspection instruments and more than 100 test equipments which are introduced and developed alone by ZWZ, there are about over 200 kinds of different design and dimension bearings test completed.



8.1 Material Performance Inspection and Lubrication Sealed Test Equipment

Material inspection equipment can do testing analysis on bearing parts material composition, microstructure performance. Coordinate measuring machining, roughmeter and profilometer can analyze bearing parts quality precisely, bearing dynamic analyzer can analyze the vibration noise of bearing and lubricant test equipment can make analysis and testing on different lubrication oil and grease.

8.2 Special Wheel Bearing Test Bench

Railway axle box bearing reliability under the limiting condition is tested by railway bearing test bench, ZWZ railway bearing test bench is approved by Ministry of Railways and have performed relevant performance tests on domestic and foreign bearings many times according to Ministry of Railways requirements.

The special axle box bearing test bench can

do tests on double-row tapered roller bearing and cylindrical roller bearing under stable radial load and alternating axial load, and provide testing results of radial load, axial load, temperature and noise. Because airflow has great influence on cooling axle box and axle box bearing in actual operation, the test bench is installed with wind cooling device whose simulated wind speed reaches 180km/h. According to TB/T3000 or DINEN 12082

standard., the test bench can make temperature rise performance and durability test, resistance to high and low temperature test and resistance to injection water infiltration test that includes injecting water continuously under the condition of still bearing axle box or with different working speed and no water is allowed to seep into the bearing in every testing working condition. DINEN 12082 standard., the test bench can make temperature rise performance and durability test, resistance to high and low temperature test and resistance to injection water infiltration test that includes injecting water continuously under the condition of still bearing axle box or with different working speed and no water is allowed to seep into the bearing in every testing working condition.



9. Wheel Bearing Installation and Maintenance

The railway wheel bearing unit is double-row tapered roller bearing or double-row cylindrical roller bearing, used in locomotive, passenger car, truck and urban rail transit vehicle. They have adjusted clearance, added lubrication grease and sealed safely when leaving factory. The bearings can be pushed to install on axle journal in the way of hydraulic pressure mode which is very simply and convenient, the can be pressed in the axle journal by only one step operation and fixed by bolts and attachments. When the axle journal and bearing ID dimension conform to the specified tolerances, bearings can reach the required axial clearance.

9.1 Bearing Press-fitting

(1) Bearing press-fitting should be performed in the clean and bright workshop. The equipment, tool and measuring instrument used in press-fitting should be kept clean.

(2) Before bearing press-fitting, scrap iron and dirt inside the center hole of shaft end and 3 bolt holes should be cleared away. Clean axle journal and dust guard seat, then measure axle journal, cylindricity and dust guard seat diameter. Then brush with antirust grease special for wheel axle journal with the thickness over 1mm on mounting face of root of axle journal, back porch of axle journal and dust guard seat. After that, paint antirust extreme pressure lithium-based grease type II on the axle journal uniformly.

(3) Install guide sleeve to the axle journal when bearing press-fitting, use sleeve for alignment and push bearing units to axle journal from the guide sleeve through hydraulic device. During press-fitting, Turn the bearing outer ring by hand and make it rotating flexible, in order to avoid clamping stagnation. If there is clamping stagnation, press-fitting must be stopped to check. Set press mounting force and end fitting force according to technical conditions of bearing press-fitting to make sure bearings are fitted in place.

(4) After press-fitting, the axial clearance value measured under specified axial thrust (tension) and the radial clearance after bearing mounting should conform to the technical requirements. Meanwhile, take running-in test that the rotation speed is higher than 200r/min and time is more than 5min. When doing test, the bearing rotation should have no abnormal noise.

9.2 Bearing Disassembly

When wheels need to be disassembled and the breakdown bearings need overhauling, the bearings need to be dismantled from the axle. No matter under what conditions, once the bearings are dismantled from axle, bearings must be disintegrated, cleaned, checked and made necessary repair.

Disassembly of bearing unites are the same as assembly with the help of guide sleeve and mounting sleeve or portable device. The force required by dismantling bearing from axle is about 20% higher of press mounting force.

When dismount the bearing from axle, it needs a guide sleeve fixed on the shaft end or pressure

head to ensure the bearing parts are still a whole and not damaged. When take bearing off the guide sleeve, do not casually throw bearing to the ground from the high, in order to prevent bearing from damage.

Pay attention that traction horseshoe-shaped housing dimension matches with bearing dismounting size. It is greatly important for mounting and dismantling bearings successfully that the traction horseshoe-shaped housing connects with back ring well, and detacher and the axle journal are kept coaxial. Or the forces will be uneven and lead to hard dismantling.

9.3 Maintenance and Overhauling During Operation

When vehicle runs for a certain range or needs overhauling for other reasons, the bearing units must be carefully checked to see if bearing is too hot, the lubricant leaks, sealed parts are damaged and if there is crack on the bearing outer ring, end cover and axle box body. If there is a problem, the bearing need to be dismantled, checked and repaired. When bearings run achieving the required design or mileage (subject to the first coming), then they need overhauling.

10. Railway Bearing Technical Services

Our company can provide all-around professional technical service and high quality products to customers, the service range covers technical consultation in the field of practical application, product design, application calculation and test. Network of sales engineers, service and technical personnel for railway bearing spread across the country to make sure ZWZ make rapid response to customer demand.

Railway Journal Box Double-row Tapered Roller Bearing

d 99-150 mm

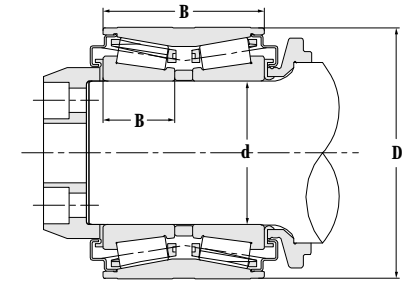
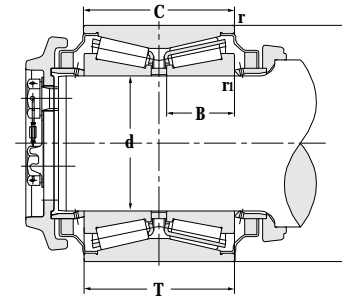
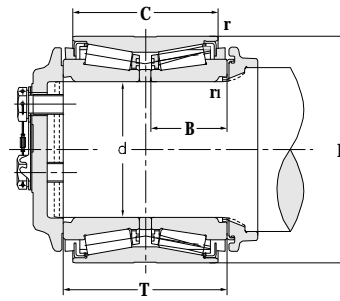
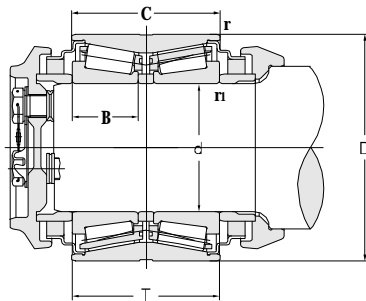

Principal dimensions						Basic load ratings			
d	D	T	B	C	r _{min}	r _{1min}	C _r	Cor	
mm	mm	mm	mm	mm	mm	mm	kN		
99	182	117	52	117	2.5	1	535	917	
99.5	182	117	52	117	2.5	1	535	917	
	182	112	46	112	3	0.7	510	867	
100	182	112	46	112	3	0.7	510	867	
	182	117	52	117	2.5	1	535	917	
110	195	126	57.658	131.35	1.5	0.6	570	1170	
119.062	195.262	136.525	57.15	142.875	1.5	0.6	570	1170	
	195.262	136.525	57.15	142.875	1.5	0.6	620	1050	
	195.262	136.525	57.15	142.875	1.5	0.6	620	1050	
130	230	150	67	150	2.5	1	882	1590	
	230	176	79.5	160	8	0.8	870	1600	
	230	166.35	75.675	150	2.5	1	870	1600	
	230	150	67	150	2.5	1	890	1640	
144.45	220.663	155.576	58.738	163.627	1.778	1.626	760	1310	
	220.663	155.576	58.738	163.627	1.473	1.626	760	1310	
	220.663	155.576	58.738	163.627	1.778	1.626	760	1310	
	220.663	155.576	58.738	163.627	1.473	1.626	760	1310	
150	250	180.6	83.15	160	3	1	968	1800	
	250	180.6	83.15	160	3	1	968	1800	
	250	180.6	83.15	160	2	1	1000	1930	
	250	181.3	83.5	160	2	1	960	1900	
	250	154.5	70.25	160	2.5	1	900	1820	
	260	187	86.5	160	2.5	0.5	1060	2040	
	250	156	71	160	2.5	0.5	962	1926	
	250	156	71	160	2.5	0.5	962	1900	
	270	170	75	170	2.5	0.7	1220	2470	
	270	170	75	170	2.5	0.7	1220	2470	
	270	170	75	170	2.5	0.7	1220	2470	
	270	170	75	170	2.5	0.7	1220	2470	

Designations	Calculation coefficient				Weight kg	Mounting position
	e	Y1	Y2	Yo		
	mm					
197720K2ZC	0.26	2.55	3.80	1.25	21.8	Railway wagon journal box free bearing
197720K1ZC 97720K	0.26	2.55	3.80	1.25	21.8	Railway wagon journal box free bearing
	0.40	1.68	2.50	0.82	12.9	Railway wagon journal box free bearing
97720 197720ZC	0.40	1.68	2.50	0.82	12.9	Railway wagon journal box free bearing
	0.26	2.55	3.80	1.25	15.7	Railway wagon journal box free bearing
35222X3-2RS-ZC	0.26	2.55	3.80	1.25	21.3	Railway wagon journal box free bearing
3506/119X4-2RS-ZC HM124646/HM124618XD 197924	0.26	2.55	3.80	1.25	22.1	Railway wagon journal box free bearing
	0.26	2.55	3.80	1.25	19.9	Railway wagon journal box free bearing
	0.26	2.55	3.80	1.25	25.3	Railway wagon journal box free bearing
352226X2-2RZ-ZC 352226GS 352226X2B 352226X2A-ZC	0.26	2.55	3.80	1.25	28.84	Railway wagon wheel set journal box free
	0.26	2.55	3.80	1.25	28	Railway high-speed vehicle journal box
	0.26	2.55	3.80	1.25	29	Subway vehicle journal box
	0.25	2.69	4.00	1.31	28.82	Railway wagon wheel set journal box free
KHM129848/KHM129814XD HM129848/HM129814XD TBU6X11-1 TBU6X11	0.26	2.56	3.81	1.25	23	Railway wagon journal box free for export
	0.26	2.56	3.81	1.25	18.2	Railway wagon journal box free for export
	0.26	2.56	3.81	1.25	25.9	Railway wagon journal box free for export
	0.26	2.56	3.81	1.25	25	Railway wagon journal box free for export
353130B 353130B-ZC 353130X2-2RS-ZC 353130X2-2RS-1-ZC 353130X2-2RS-2-ZC 353130X3-2RS-ZC 353130X2-2RZ-ZC 353130A-ZC 197730 197730Y 197730Y1 197730Y2	0.26	2.56	3.81	1.25	32.3	Railway wagon wheel set journal box free
	0.26	2.56	3.81	1.25	41.2	Railway wagon journal box free for export
	0.26	2.55	3.80	1.25	32.1	Railway wagon journal box free for export
	0.26	2.55	3.80	1.25	41.6	Railway wagon journal box free for export
	0.26	2.55	3.80	1.25	34.4	Railway wagon journal box free for export
	0.26	2.55	3.80	1.25	48.1	Railway wagon journal box free for export
	0.26	2.55	3.80	1.25	35.48	Railway wagon journal box free for export
	0.26	2.55	3.80	1.25	35.48	Railway wagon journal box free for export
	0.27	2.47	3.67	1.21	43.8	Railway wagon journal box free for export
	0.27	2.47	3.67	1.21	46.8	Railway wagon journal box free for export
	0.27	2.47	3.67	1.21	42.9	Railway wagon journal box free for export
	0.27	2.47	3.67	1.21	46.8	Railway wagon journal box free for export

Railway Journal Box Double-row Tapered Roller Bearing

d 157.15~177.787 mm

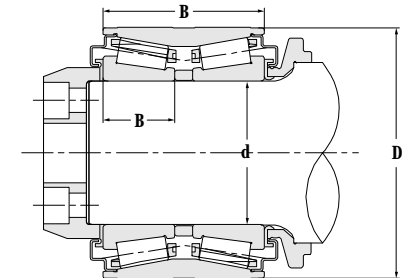
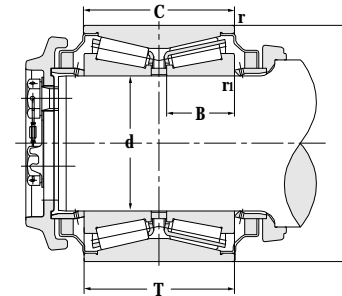
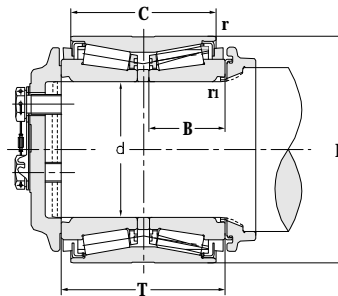
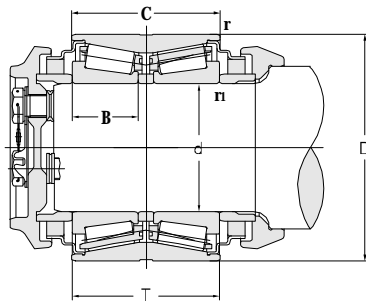

Principal dimensions						Basic load ratings		
d	D	T	B	C	r _{min}	r _{1min}	C _r	C _{or}
mm	mm	mm	mm	mm	mm	mm	kN	
157.15	252.489	177.8	69.85	184.277	1.778	1.626	910	1850
	252.489	177.8	69.85	184.277	1.778	1.626	910	1850
160	270	195	91	170	2.5	0.5	1200	2370
	270	195	90.5	170	2.5	1	1200	2320
	270	195	90.5	170	3	1	1300	2400
	280	180	80	180	1	2	1250	2390
165.087	301.701	190.5	87.312	196.85	4.8	1	1320	2660
	301.701	190.5	87.312	196.85	4.8	1	1320	2660
	301.701	190.475	87.3	196.85	4.8	0.5	1540	2960
	301.701	191.745	87.312	196.85	0.5	2	1540	2960
170	305	190.5	87.3	196	4.8	1	1320	2650
174.612	301.701	191.745	87.3	196.85	4.8	1	1540	2960
	301.701	190.475	87.312	196.85	2	0.5	1540	2960
175	305	190.475	87.3	196	4.8	1	1320	2650
	305	190.475	87.3	196	4.8	1	1320	2650
177.787	276.225	180.975	74.612	185.852	1.5	1	1130	2520
	276.225	180.975	74.612	185.852	1.5	1	1130	2520
	276.225	181.36	74.612	185.72	2	0.5	1380	2630

Designations	Calculation coefficient				Weight	Mounting position
	e	Y1	Y2	Yo		
	mm				kg	
TBU61/2X12	0.26	2.56	3.81	1.25	36.8	Railway wagon journal box free bearing for export
KHM133444/KHM133416XDA	0.26	2.56	3.81	1.25	36.8	Railway wagon journal box free bearing for export
352132A-ZC	0.26	2.55	3.80	1.25	40.5	Railway wagon wheel set journal box free
353132X2A-ZC	0.26	2.55	3.80	1.25	53.3	Railway wagon wheel set journal box free
353132X2-2RS-ZC	0.26	2.55	3.80	1.25	53	Railway wagon wheel set journal box free
352132X3	0.26	2.55	3.80	1.25	46.1	Railway "Harmonious" series journal box
197933	0.35	1.95	2.90	0.95	72	Railway locomotive wheel set journal box free
197933S	0.35	1.95	2.90	0.95	72	Railway locomotive wheel set journal box free
GG6 1/2	0.29	1.95	3.45	1.13	77.3	Railway wagon journal box free for export
GG6 1/2-1	0.35	2.32	2.90	0.95	65.9	Railway wagon journal box free for export
350634X3-2RS	0.35	1.95	2.90	0.95	66	Railway locomotive wheel set journal box free
GG6 7/8	0.29	2.32	3.45	1.13	72.2	Railway wagon journal box free for export
GG6 7/8-1	0.35	1.95	2.9	0.95	59.1	Railway wagon journal box free for export
197735	0.35	1.95	2.90	0.95	63.7	Railway wagon journal box free
197735ZC	0.35	1.95	2.90	0.95	77.2	Railway wagon journal box free
197935	0.26	2.55	3.80	1.25	44.5	Railway wagon journal box free
197935ZC	0.26	2.55	3.80	1.25	59.7	Railway wagon journal box free
7x12	0.26	2.55	3.8	1.25	40.0	Railway wagon journal box free for export

Railway Journal Box Single-row Tapered Roller Bearing



d 120~130 mm

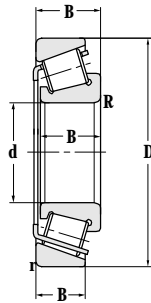

Principal dimensions							Basic load ratings	
d	D	T	B	C	R _{min}	r _{min}	C _r	C _{or}
mm	mm	mm	mm	mm	mm	mm	kN	
120	180	48	48	38	2.5	2	295	530
130	230	67.75	64	54	4	3	560	855

Limit speed ratings		Designations	Calculation coefficient				Weight	Mounting position
转速 (Grease)	转速 (Oil)		e	Y1	Y2	Yo		
r/min	r/min		mm			kg		
1800	2600	33024A	0.31	2	1.1	36	4.17	Light rail axle box
1500	2000	32226A	0.44	1.4	0.76	57	11.7	Light rail axle box

Railway Journal Box Single-row Cylindrical Roller Bearing

d 80-130 mm

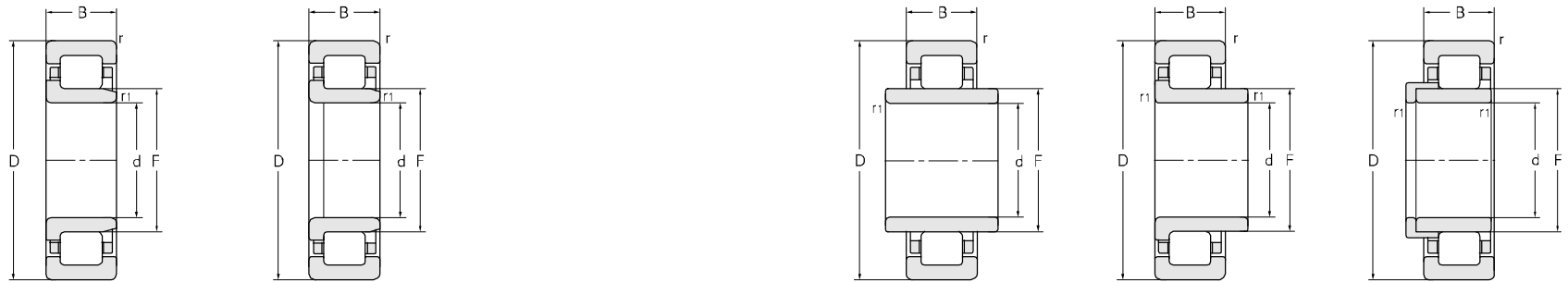

Principal dimensions						Basic load ratings	
d	D	B	r _{Smin}	r1 _{Smin}	F	C _r	C _{or}
mm	mm	mm	mm	mm	mm	kN	
80	150	45	2	2	97	245	320
	150	45	2	2	97	245	320
	150	90	2	2	97	420	640
100	180	60.3	2.1	2.1	119	335	440
	180	60.3	2.1	2.1	119	335	440
	215	73	3	3	127.5	530	650
	215	73	3	3	127.5	530	650
119	240	80	3.7	3	150	535	708
	240	80	3.7	3	150	535	708
119.5	240	80	3.7	3	150	535	708
	240	80	3.7	3	150	535	708
120	240	80	3.7	3	150	535	708
	240	80	3.7	3	150	535	708
	250	80	3.7	3	158	604	807
	250	80	3.7	3	158	604	807
129.5	250	80	3.7	3	158	604	807
	250	80	3.7	3	158	604	807
130	220	62	2.1	2.1	150	480	675
	220	62	2.1	2.1	150	480	675
	230	64	3	3	156	410	590
	230	64	3	3	156	410	590
	240	80	3	3	156	580	800
	240	80	3	3	156	580	800
	240	160	3	3	156	580	800
	250	80	3.7	3	158	604	807
	250	80	3.7	3	158	604	807
	280	93	4	4	167	880	1160
	280	93	4	4	167	880	1160

Limit speed ratings		Designations	Weight	Mounting position
Grease	Oil			
r/min	r/min		kg	
3700	4500	NJ3216X3M/P54 NJP3216X3M/P54 NJ/NJP3216X3M/P54	3.69	Tourist coach axle box
3700	4500		3.69	Tourist coach axle box
3700	4500		7.40	Tourist coach axle box
3200	3800	NJ3220TN1/HG2P54 NJP3220TN1/HG2P54 4G42620EQT 4G152620EQT	6.00	Railway vehicle axle box Subway vehicle axle box
3200	3800		5.98	Railway vehicle axle box Subway vehicle axle box
2560	3150		13.4	Railway vehicles axle box
2560	3150		13.5	Railway vehicles axle box
2400	3200	42724QK1T 152724QK1T	17.3	Railway passenger car axle box
2400	3200		17.4	Railway passenger car axle box
2400	3200	152724QKT 42724QKT	17.2	Railway passenger car axle box
2400	3200		17.2	Railway passenger car axle box
2400	3200	42724QT 152724QT	17.1	Railway passenger car axle box
2400	3200		17.2	Railway passenger car axle box
1800	2200	NJ3226X1K2 NJP3226X1K2	18.4	Railway passenger car axle box
1800	2200		18.6	Railway passenger car axle box
1800	2200	NJ3226X1K1 NJP3226X1K1	18.4	Railway passenger car axle box
1800	2200		18.5	Railway passenger car axle box
2200	2800	NJ2226X3TN1/HG2P64 NJP2226X3TN1/HG2P64 NJ2226Q1/C4S0 NJP2226Q1/C4S0 NJ3226X1SCTN NJP3226X1SCTN NJ/NJP3226X1SCTN NJP3226X1 NJ3226X1 4G42626EQT 4G152626EQT	8.69	Railway vehicle axle box
2200	2800		8.68	Railway vehicle axle box
2200	2800		11.9	Railway locomotive security vehicle axle box
2200	2800		11.9	Railway locomotive security vehicle axle box
2200	2800		14.95	Quasi high speed passenger car axle box
2200	2800		14.79	Quasi high speed passenger car axle box
2200	2800		29.74	Quasi high speed passenger car axle box
1800	2200		18.5	Railway passenger car axle box
1800	2200		18.3	Railway passenger car axle box
2560	3150		29	Railway vehicles axle box
2560	3150		29	Railway vehicles axle box

Railway Journal Box Single-row Cylindrical Roller Bearing

d 140~158.5 mm

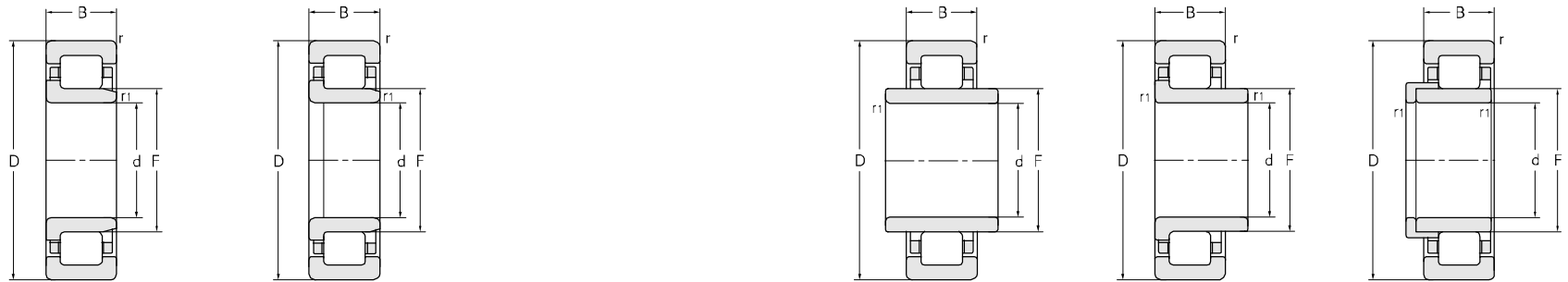

Principal dimensions						Basic load ratings	
d	D	B	r _{Smin}	r _{1Smin}	F	C _r	C _{or}
mm	mm	mm	mm	mm	mm	kN	
140	250	68	3	3	169	510	755
	250	68	3	3	169	510	755
160	290	80	3	3	193	935	1130
	290	80	3	3	193	935	1130
	290	80	3	3	193	935	1130
	290	80	3	3	193	935	1130
	290	80	3	3	193	935	1130
	290	80	3	3	193	935	1130
	290	80	3	3	193	935	1130
	290	80	3	3	193	935	1130
	290	80	3	3	193	935	1130
	290	80	3	3	193	935	1130
	290	80	3	3	193	935	1130
	290	80	3	3	193	935	1130
	290	80	3	3	193	935	1130
159.5	290	80	3	3	193	935	1130
	290	80	3	3	193	935	1130
	290	80	3	3	193	935	1130
	290	80	3	3	193	935	1130
	290	80	3	3	193	935	1130
	290	80	3	3	193	935	1130
159	290	80	3	3	193	935	1130
	290	80	3	3	193	935	1130
	290	80	3	3	193	935	1130
	290	80	3	3	193	935	1130
	290	80	3	3	193	935	1130
	290	80	3	3	193	935	1130
158.5	290	80	3	3	193	935	1130
	290	80	3	3	193	935	1130
	290	80	3	3	193	935	1130
	290	80	3	3	193	935	1130
	290	80	3	3	193	935	1130
	290	80	3	3	193	935	1130

Limit speed ratings		Designations	Weight	Mounting position
Grease	Oil			
r/min	r/min		kg	
2000	2600	NJP2228Q1/C4S0 NJ2228Q1/C4S0	15.1	Engineering vehicle axle box
2000	2600		15.1	
1800	2200	NU2232WBQ1/YB2 NJ2232WB1Q1/YB2	24.8	Railway locomotive axle box
1800	2200		26	
1800	2200	NU2232WBQ1/YB2+HJR2 NU2232WBQ1/YB2+HJR1	26.5	Railway locomotive axle box
1800	2200		27.1	
1800	2200	NU2232WBQ1/YB2+HJR1 NU2232WB	27.1	Railway locomotive axle box
1800	2200		24.8	
1800	2200	NUHJ2232WB NJ2232WB	27.2	Railway locomotive axle box
1800	2200		26	
1800	2200	NUHJ2232WB1 NJ2232WB11Q1/YB2	26.6	Railway locomotive axle box
1800	2200		24.2	
1800	2200	NJ2232WB1 NUHJ2232WB1	24.2	Railway locomotive axle box
1800	2200		27.2	
1800	2200	NU2232WBK NJ2232WBK	24.8	Railway locomotive axle box
1800	2200		26	
1800	2200	NUHJ2232WBK NUHJ2232WB1K	27.2	Railway locomotive axle box
1800	2200		26.6	
1800	2200	NUHJ2232WB1K NJ2232WB1K	27.2	Railway locomotive axle box
1800	2200		24.3	
1800	2200	NJ2232WBK1 NUHJ2232WBK1	26	Railway locomotive axle box
1800	2200		27.2	
1800	2200	NU2232WBK1 NUHJ2232WB1K1	24.8	Railway locomotive axle box
1800	2200		26.6	
1800	2200	NUHJ2232WB1K1 NJ2232WB1K1	27.2	Railway locomotive axle box
1800	2200		24.4	
1800	2200	NJ2232WBK2 NU2232WBK2	26.4	Railway locomotive axle box
1800	2200		25.0	
1800	2200	NUHJ2232WBK2 NUHJ2232WB1K2	27.4	Railway locomotive axle box
1800	2200		26.9	
1800	2200	NUHJ2232WB1K2 NJ2232WB1K2	27.5	Railway locomotive axle box
1800	2200		24.5	

Railway Journal Box Single-row Cylindrical Roller Bearing

d 158 mm

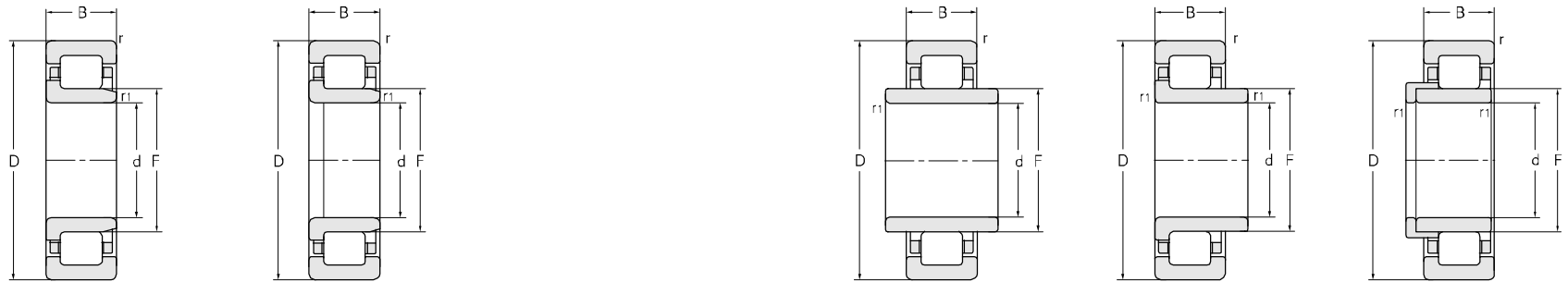

Principal dimensions						Basic load ratings	
d	D	B	r _{Smin}	r1 _{Smin}	F	C _r	C _{or}
mm	mm	mm	mm	mm	mm	kN	
158	290	80	3	3	193	935	1130
	290	80	3	3	193	935	1130
	290	80	3	3	193	935	1130
	290	80	3	3	193	935	1130
	290	80	3	3	193	935	1130
	290	80	3	3	193	935	1130

Limit speed ratings		Designations	Weight	Mounting position
Grease	Oil			
r/min	r/min		kg	
1800	2200	NJ2232WBK3	26.5	Railway locomotive axle box
1800	2200	NU2232WBK3	25.1	Railway locomotive axle box
1800	2200	NUHJ2232WBK3	27.5	Railway locomotive axle box
1800	2200	NUHJ2232WBY1K3	27.0	Railway locomotive axle box
1800	2200	NUHJ2232WBYK3	27.6	Railway locomotive axle box
1800	2200	NJ2232WBYK3	24.6	Railway locomotive axle box

Railway Journal Box Double-row Cylindrical Roller Bearing

d 159~160 mm

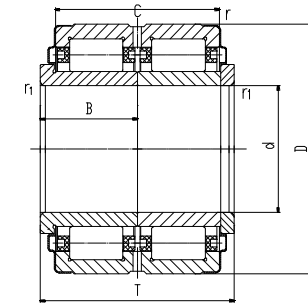
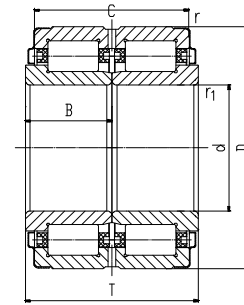
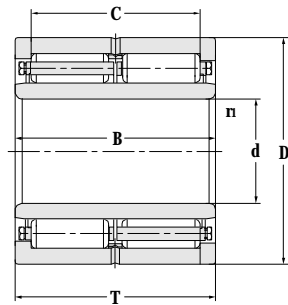
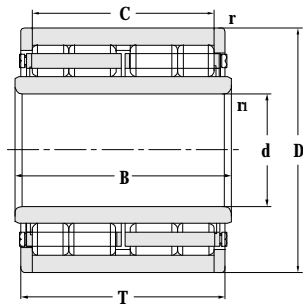

Principal dimensions

Basic load ratings

d	D	B	C	T	r _{Smin}	r1 _{Smin}	F	C _r	C _{or}
mm	mm	mm	mm	mm	mm	mm	mm	kN	
159	290	220	178	220	3	3	191	1900	3580
159.5	290	220	178	220	3	3	191	1900	3580
160	270	85	146	170	3	3	182	1080	1830
	270	88	146	176	3	3	182	1080	1830
	280	90	155	180	3	3	190	1250	2160
	290	220	178	206	3	3	191	1900	3580
	290	180	152	180	3	3	191	1870	3520
	290	180	152	180	3	3	191	1870	3520

Designations

Weight

Mounting position

	kg	
972832K1QT	67.5	Railway locomotive axle box
972832KQT	67.3	Railway locomotive axle box
NNJ5132X2	34	Railway "harmonious" series locomotive axle box
NNUP5132X2	33.9	Railway "harmonious" series locomotive axle box
NNUP5232X3	40.8	Railway "harmonious" series locomotive axle box
972832QT	67.2	Railway locomotive axle box
982832QT	56.8	Railway locomotive axle box
982832Q1T	54.4	Railway locomotive axle box

Railway Bearing (Type 0 Open)

d 60-170 mm

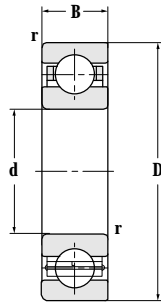

Principal dimensions				Basic load ratings		Limit speed ratings	
d	D	B	r _{min}	C _r	C _{or}	Grease	Oil
mm	mm	mm	mm	kN		r/min	r/min
60	130	31	2.1	82.0	52.0	5300	6300
170	260	42	2.1	170	171	2200	2800

Designations(New)	Designations(Old)	Weight	Mounting position
		kg	
6312Q/P64S0	4E312QT	2.07	Locomotive traction motor Railway locomotive traction motor
6034Q/C4S0	4G134QT	7.94	Railway locomotive axle box

Railway Bearing (Type 2 Open)

d 80-150 mm

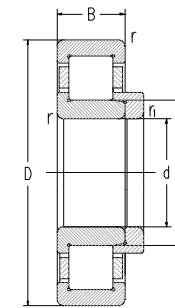
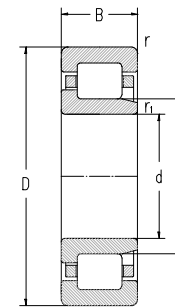
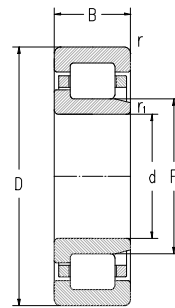
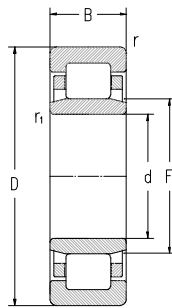

Principal dimensions						Basic load ratings		Limit speed ratings	
d	D	B	r _{Smin}	r1 _{Smin}	F	C _r	C _{or}	Grease	Oil
mm	mm	mm	mm	mm	mm	kN		r/min	r/min
80	140	26	2	2	95	135	170	4000	4800
	170	39	2.1	2.1	103	204	228	3200	3800
	170	58	2.1	2.1	103	304	380	3200	3800
85	210	52	4	4	113	400	485	2900	3600
90	190	43	3	3	115	270	315	2800	3400
	190	43	3	3	115	270	315	2800	3400
	190	43	3	3	113.5	300	330	2590	3190
95	200	67	3	3	121.5	413	530	2600	3200
	215	47	3	3	129.5	335	370	2400	3000
	215	47	3	3	129.5	335	370	2400	3000
110	240	50	3	3	143	455	515	2000	2600
	240	80	3	3	143	610	770	2000	2600
120	215	40	2.1	2.1	143.5	375	485	2400	3000
	310	72	5	5	170	730	855	1900	2400
130	230	64	3	3	153.5	525	735	2200	2800
	280	58	4	4	167	565	680	1800	2200
	280	93	4	4	167	780	1060	1800	2200
	280	93	4	4	167	780	1060	1800	2200
	340	78	4.7	4.7	185	890	1030	1800	2200
	340	78	4.7	4.7	185	890	1030	1800	2200
	340	78	4.7	4.7	185	890	1030	1800	2200
	340	78	4.7	4.7	185	890	1030	1800	2200
140	300	62	4	4	180	625	760	1900	2400
	300	62	4	4	180	625	760	1900	2400
	300	62	4	4	180	680	820	1800	2200
	300	62	4	4	180	680	820	1800	2200
	300	62	4	4	180	680	820	1800	2200
150	270	45	3	3	182	460	610	1900	2400
	320	65	4	4	193	770	945	1700	2000

Designations(New)	Designations(Old)	Weight	Mounting position
		kg	
NU216Q1		1.74	Subway gearbox
NU316Q/P64S0	4E32316QT	4.45	Locomotive traction motor
NU2316Q/P63S0Y	3E32616QKT	6.23	Locomotive axle gearbox
NUP417Q/C9S0	92417QTU	10.4	Locomotive traction motor
NH318Q/C4S0	4G62318QT	6.63	Locomotive traction motor
NH318Q/C9S0	62318QTU	6.63	Locomotive traction motor
NH318EQ1/YB2		6.64	Traction motor
NU2319Q/C4S0	4G32619QT	9.86	Locomotive axle gearbox
NH320Q/S0	62320QT	9.64	Locomotive traction motor
NH320Q/C9S0	62320QTU	9.64	Locomotive traction motor
NH322Q/S0	62322QT	13.0	Locomotive traction motor
NU2322EQ/S0	32622EQT	17.6	Locomotive axle gearbox
NU224EQ/P63S0	3E3224EQT	6.88	Locomotive axle gearbox
NU424Q/C4S0	4G32424QT	28.8	Locomotive traction motor
NU2226EQ/P63S0	3E32526EQT	11.1	Locomotive axle gearbox
NU326Q/S0	32326QT	17.9	Locomotive main electric generator
	E32626QTY	29.3	Locomotive main electric generator
	32626QTY	29.3	Locomotive main electric generator
NU426Q/P6S0Y	E32426QTY	38.8	Locomotive traction motor
NU426Q/P6S0Y1	E32426QTY1	38.8	Locomotive traction motor
NU426Q/S0Y	32426QTY	38.8	Locomotive traction motor
NJ328Q/C4S0	4G42328QT	22.1	Locomotive traction motor
NU328Q1/P63S0		21.7	Locomotive traction motor
NJ328EQ/S0	42328EQT	23.8	Locomotive traction motor
NU328E/S0	32328ET	21.9	Locomotive traction motor
NU230EQ/P63S0	3E32230EQT	11.8	Locomotive axle gearbox
NU330EQ/C4S0	4G32330EQT	26.2	Locomotive traction motor

Railway Bearing (Type 2 Open)

d 150~380 mm

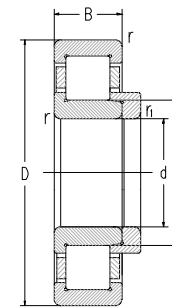
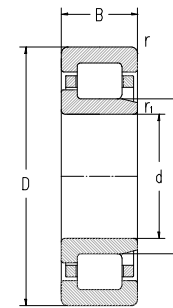
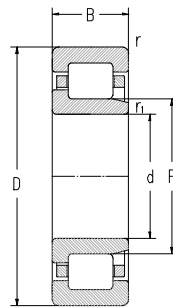
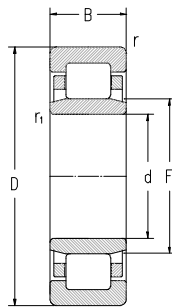

Principal dimensions						Basic load ratings		Limit speed ratings	
d	D	B	r _{smin}	r1 _{smin}	F	C _r	Cor	Grease	Oil
mm	mm	mm	mm	mm	mm	kN		r/min	r/min
150	320	65	4	4	193	770	945	1700	2000
	320	65	4	4	193	770	945	1700	2000
	320	65	4	4	193	770	945	1700	2000
	320	65	4	4	193	770	945	1700	2000
	320	65	4	4	193	770	945	1570	1930
160	340	68	4	4	204	910	1150	1500	1800
	340	68	4	4	204	910	1150	1500	1800
220	340	56	3	3	250	520	780	1800	2200
379.5	480	60	2.1	2.1		550	680	700	890
	480	60	2.1	2.1	406	550	680	700	890
380	480	60	2.1	2.1		550	680	700	890
	480	60	2.1	2.1	406	550	680	700	890

Designations(New)	Designations(Old)	Weight	Mounting position
		kg	
NU330EQ	32330EQ	26.2	Locomotive traction motor
NU330EQ/C9	32330EQU	26.2	Locomotive traction motor
NU330EQ/P69S0	E32330EQTU	26.0	Locomotive traction motor
NU330EQ/S0	32330EQT	26.2	Locomotive traction motor
NU330EQ1/YB2		26.7	Traction Motor
NU332EQ/S0	32332EQT	27.8	Locomotive traction motor
NU332EQ	32332EQ	27.8	Locomotive traction motor
NU1044Q/P63S0	3E32144QT	19.4	Locomotive axle gearbox
N2876K/P69		26	Locomotive wheel set hollow shaft
NUP2876K/P69		27.1	Locomotive wheel set hollow shaft
N2876/P69		25.9	Locomotive wheel set hollow shaft
NUP2876/P69		27	Locomotive wheel set hollow shaft

Railway Bearing (Type 3)

d 70–280 mm

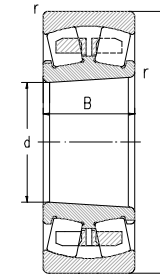
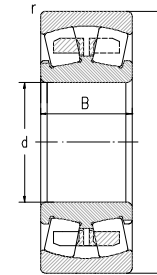
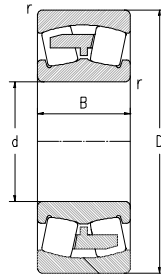

Principal dimensions				Basic load ratings		Limit speed ratings	
d	D	B	r _{Smin}	C _r	C _{or}	Grease	Oil
mm	mm	mm	mm	kN		r/min	r/min
70	150	51	2.1	285	325	2200	3000
75	160	55	2.1	330	395	2200	3000
80	170	58	2.1	413	455	2000	2800
90	190	64	3	420	410	1800	2400
130	280	93	4	1060	1250	1300	1700
	280	93	4	930	1210	1300	1700
	280	93	4	930	1210	1300	1700
160	270	86	2.1	840	1350	1300	1700
170	320	108	3.7	1160	1790	950	1200
180	300	118	3	1170	2030	950	1300
240	360	92	3	1060	2430	1000	1400
280	380	75	2.1	770	1850	1000	1400

Designations (New)	Designations (Old)	Calculation coefficient				Weight kg	Mounting position
		e	Y1	Y2	Y0		
		mm					
22314Q/C3S0	3G3614QT	0.37	1.80	2.70	1.80	4.21	Locomotive axle gearbox
22315Q/C3S0	3G3615QT	0.39	1.75	2.61	1.71	5.29	Locomotive axle gearbox
22316Q/C3S0	3G3616QT	0.37	1.80	2.70	1.80	6.19	Locomotive axle gearbox
22318Q/C3S0	3G3618QT	0.36	1.87	2.79	1.83	8.56	Locomotive traction motor
22326CAQ/S0	53626QT	0.34	1.99	2.96	1.94	18.1	Locomotive main electric generator
22326Q/C3S0	3G3626QT	0.36	1.87	2.79	1.83	27.2	Locomotive main electric generator
22326Q/S0	3626QT	0.36	1.87	2.79	1.83	27.2	Locomotive main electric generator
23132CAQ/C3S0	3G3053732QT	0.30	2.30	3.40	2.20	21.8	Locomotive axle box
	3G113734T	0.36	1.87	2.79	1.83	38.8	Locomotive axle box
24136CA/C3S0	3G4053736T	0.37	1.80	2.70	1.80	33.0	Locomotive axle box
23048Q/S0	3003148QT	0.25	2.70	4.00	2.60	34.5	Locomotive axle gearbox
23956CAQ/C3S0Y	3G3053956QKT	0.18	3.80	5.66	3.72	25.7	Locomotive traction motor journal sticking

Railway Bearing (Type 6)

d 120~170 mm

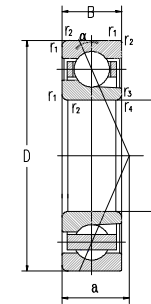
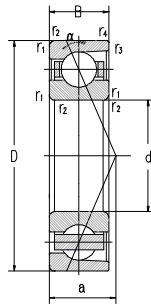

Principal dimensions					Basic load ratings		Limit speed ratings	
d	D	B	r12 _{min}	r34 _{min}	C _r	C _{or}	Grease	Oil
mm	mm	mm	mm	mm	kN		r/min	r/min
120	215	40	2.1	1.3	189	183	3200	4500
140	250	42	3	1.1	218	235	2200	3000
160	240	38	2.1	1.1	160	237	2000	2700
170	260	42	2.1	1.1	198	227	1900	2500

Designations (New)	Designations (Old)	Weight	Mounting position
		kg	
B7224ACQ1/HAS0	146224QT	6.45	Locomotive axle box
B7228ACQ/P6S0	E146228QT	8.7	Locomotive intermediate gearbox
B7032ACQ/S0	146132QT	5.74	Locomotive axle box
7034ACQ/S0	46134QT	8.27	Locomotive axle box

Railway Bearing (Four-point Contact Ball Bearing)

d 75–240 mm

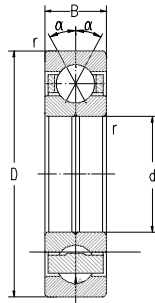

Principal dimensions				Basic load ratings		Limit speed ratings	
d	D	B	r _{min}	C _r	C _{or}	Grease	Oil
mm	mm	mm	mm	kN		r/min	r/min
75	130	25	1.5	120	122	5600	7500
85	149	28	2	155	160	4800	6700
110	240	50	3	343	405	2000	2600
150	270	45	3	336	470	1600	2100
220	340	56	3	398	650	1100	1500
240	360	56	3	430	750	1000	1300

Designations (New)	Designations (Old)	Weight	Mounting position
		kg	
QJ215N2-WTL		1.50	Subway gearbox
QJ217X1N2-WTL		2.20	Subway gearbox
QJ322QN2/P63S0	3E176322QKT	11.7	Locomotive axle gearbox
QJ230QN2/P63S0	3E176230QKT	12.0	Locomotive axle gearbox
QJ1044QN2/P63S0	3E176144QKT	17.8	Locomotive axle gearbox
QJ1048QN2/P63S0	3E176148QKT	20.9	Locomotive axle gearbox

Railway bearing (Type 7)

d 95--247.175 mm

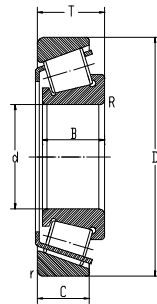

Principal dimensions							Basic load ratings		Limit speed ratings	
d	D	T	B	C	R _{min}	r _{min}	C _r	C _{or}	Grease	Oil
mm	mm	mm	mm	mm	mm	mm	kN		r/min	r/min
95	170	45.5	43	37	3	2.5	300	415	1900	2800
210	285	41	40	33	4	3	360	710	1100	1400
215.9	285.75	46.038	46.038	34.925	3.3	3.6	370	780	1000	1500
254	324.975	39	41.5	28	3.3	1.5	315	800	850	1080
254	324.975	39	41.5	28	3.3	1.5	315	800	850	1080
254	358.775	71.438	76.2	53.975	3.3	1.5	740	1450	850	1200
255.6	342.9	57.15	63.5	44.45	3.3	1.5	512	1170	800	1020
257.175	358.775	71.438	76.2	53.975	3.3	1.5	730	1470	850	1200
257.175	358.775	71.438	76.2	53.975	3.3	1.5	770	1570	850	1200

Designations	Limit speed ratings				Weight	Mounting position
	e	Y1	Y2	Yo		
	mm				kg	
32219N1-WTL	0.42	1.4	0.79	40	4.18	Subway gearbox
30642N1-WTL	0.32	1.9	1.04	45	7.28	Subway gearbox
KLM742749/KLM742710-WTL	0.48	1.25	0.7	61	7.66	Subway gearbox
1-7009 (KJL848849/KJL848811)	0.56	1.07	0.59	71	8.06	Railway Locomotive journal sticking box
JL848849/JL848810/YB2	0.56	1.07	0.59	71	8.06	Railway Locomotive journal sticking box
M249747/M249710B/YAB	0.34	1.76	0.97	65	23.6	Subway gearbox
KM349547/KM349510(1-7008)	0.35	1.73	0.95	59	16.1	Railway Locomotive journal sticking box
M249747/M249710/YAB	0.34	1.76	0.97	65	21.2	Subway gearbox
M249747/M249710/YAD	0.33	1.8	0.99	64	21.7	Subway gearbox

Slewing Bearing

1. Coding of Slewing Bearing

ZWZ slewing bearing code consists of basic code, middle code and post code.

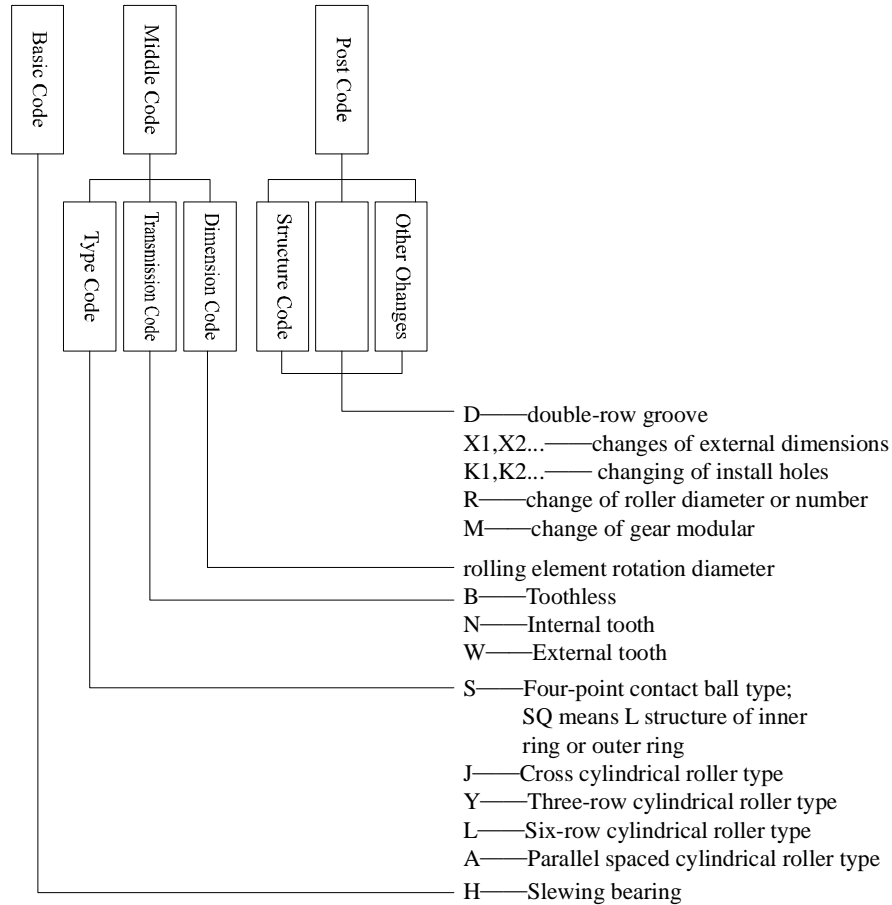

2. Modeling of Slewing Bearing

As illustration above, slewing bearing have many types. With reasonable modeling, bearings' property can be sufficiently played and ensure the service life.

2.1 Loading of Slewing Bearing

During running, slewing bearing bears combined forces of axial force F_a , radial force F_r and tilting moment M . For different applications, due to machines' different

operation modes and structures, above combined loading may be different. Sometimes there may be two forces working, whereas sometimes there only one force working.

Generally, for slewing bearings, there are three installation methods- horizontal installation, vertical installation and hung installation. The loads acting on these three installation modes are as below:

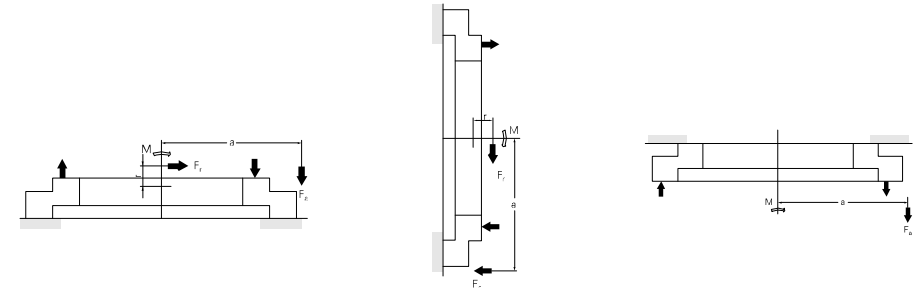

Figure1 horizontal installation Figure 2 vertical installation Figure 3 hung installation

2.2 Considerations on bearing modeling
2.2.1 External Dimension

External dimensions (ID, OD, assembly height) are pre-conditions for ensuring bearings' strength, rigidity, loading, service life and installation requirements. Loading capacity and service life can be calculated through theoretical calculation. Safety requirements are shown in Table 1.

Generally, under certain loading, service life and safety property, roller bearings' external dimensions are smaller than those of ball bearings, and single row bearings' external dimensions are smaller than those of multi-row bearings.

Regarding calculation of bearings' strength and rigidity, please consult with ZWZ.

2.2.2 Loading Capacity

For bearings whose external dimensions are more or less the same, ratings by the loading capacity, from high to low are: six-row cylindrical roller bearings, three-row cylindrical roller

bearings, four-point contact ball bearings and cross roller bearings.

2.2.3 Friction Moment

Ball bearings are better than roller bearings; single row rollers are better than multi-row rollers; the one with cage is better than that without cage. Regarding calculation of bearing starting moment and rotation moment, please consult with ZWZ.

2.2.4 Installation Precision Requirements

For ball bearings, the contact is point contact. They bear small resistance during rotation. Product error, installation clearance and supporting base distortion have small effect to bearing internal contact of balls and raceway. Under condition of the same loading, point contact stress is higher than linear contact. So the loading capacity is smaller than that of linear contact.

For roller bearings, they are linear contact. Roller bearings' contact stress is lower than

Slewing Bearing

that of ball bearings. Their loading capacity is bigger than that of ball bearings. But friction resistance caused by linear contact movement is higher than that of point contact. Meanwhile, for roller bearings, they have higher requirements on manufacture precision, installation precision, supporting base's manufacture precision and rigidity. As a result, for occasion of insufficient supporting base rigidity and bad installation environment, roller bearings are not supposed to be used for good.

2.2.5 Rigidity

The pre-condition of bearing loading calculation is to presume enough rigidity of the bearing. Bearings' rigidity refers to the elastic distortion caused by contact of rings and rolling elements under certain loading. Generally, rigidity of roller bearings is higher than that of ball bearings. Proper pre-tension (like minus clearance, etc.) and enhancing supporting base's rigidity can improve bearings'

rigidity.

2.2.6 Liability

Generally, slewing bearings bear high loads. Under preconditions of sufficient loading capacity and service life, it should maintain certain safety parameter shown in Table 1, so that bearings' liability during usage can be ensured.

2.3 Slewing Bearing Loading Curve

In product catalogue, each bearing has a loading curve chart. The curve can help customers choose slewing bearing type preliminarily. There are 2 type curves. One is static loading curve that shows max. loads when bearing stays still and the other one is limit loading curve of slewing bearing bolt (10.9 curve), which is determined when bolt holding length is 5 times bolt nominal diameter and the pre-tension is 70 % that of bolt material yield limit.

Table 1 Bearing application safety factor

Equipment		Static load safety parameter fs	Service life load parameter fl
Marine crane, automobile crane, grabbing deck crane, turntable (continuous rotation is required during operating)		1.10	1.0
Tower crane for construction	Bearings are installed on tower	1.25	1.0
	Mf ≤ 0.5M 0.5M < Mf < 0.8M Mf ≥ 0.8M		1.15
1.25			
1.0			
Bearings are installed on base			1.0
Port gantry crane, marine crane			1.15

Equipment	Static load safety parameter fs	Service life load parameter fl
Crane for metallurgy factory	1.45	1.5
Automobile crane (grabbing type or heavy load manual operated) Slewing crane (grab or magnet) Wheel crane (grab or magnet) Bridge crane (grab or magnet) Floating crane (grab or magnet)		1.7
Rope excavator Stacker reclaimer Belt cargo conveyor		2.15
Railway crane	1.0	For the slewing bearings are working under significant change conditions and rotating continuously or intermittently, the dynamic life calculation is needful.
Mini cargo conveyor	1.1	
Pulling shovel	1.25	
Hydraulic tunneller Four-point contact ball slewing bearings are adopted	1.25	
Other slewing bearings are adopted Bucket capacity < 1.5M ³	1.45	
Bucket capacity ≥ 1.5M ³	1.75	
Ladle car	1.75	

Note: Fl is the dynamic safety parameter. It is used considering dynamic loading curve (dynamic loading curve is not shown in the catalogue). It is conclusion from experience and experiments. If bearings are chosen according to service life, please contact with ZWZ technical department.

Slewing Bearing

2.4 Slewing Bearing Type Selection Method

2.4.1 Static Type Selection

(1) Type selection calculation flow

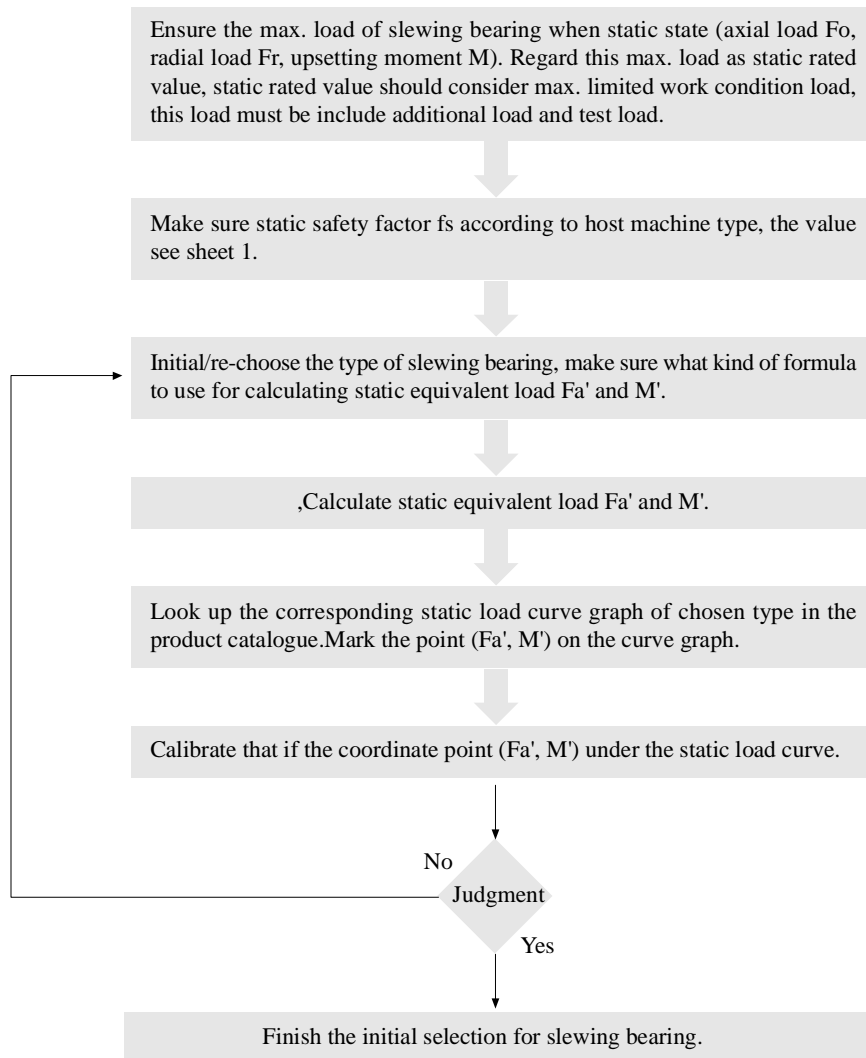

(2) Static equivalent load calculation

Table 2 Static equivalent load calculation

Slewing bearing structure type	Calculation method	Type selection according to static working condition
Four-point contact ball slewing bearing (α=45°)		M'=Mofs When Fr ≤ 0.44Fa, Fa'=(Fa+2.3Fr)·fs When Fr > 0.44Fa, please contact with ZWZ about Fa' calculation M'=Mofs
Double row angular contact thrust ball slewing bearing		M'=Mofs When Fr ≤ 10%Fa, Fa'=Fa·fs When Fr > 10%Fa, please contact with ZWZ about Fa' calculation M'=Mofs
Crossed cylindrical roller slewing bearing		M'=Mofs When Fr ≤ 0.44Fa, Fa'=(Fa+2.3Fr)·fs When Fr ≥ 0.44Fa, please contact with ZWZ about Fa' calculation M'=Mofs
Three-row cylindrical roller combined slewing bearing		Fa'=Fa·fs M'=Mofs Radial load Fr is accommodated by one row of rollers which bear the radial load

2.4.2 Dynamic Type Selection

For those applications that the slewing bearings need continuous operation, high-speed rotation and specific requirements for the lifespan, please contact with ZWZ technical department.

2.4.3 Bolt load carrying capacity calculation and verification

- 1) Regard the limit load of slewing bearing as the load of selected bolts;
- 2) Check whether the load is under the bolt

load curve;

3) If the bolt load capacity is insufficient, re-select slewing bearing or contact with ZWZ technical department.

2.5 Type Selection Parameter

In order to guarantee the bearing satisfy the application requirements, before customers decide to choose ZWZ product, please fill out relevant information about type selection in Table 3.

Table 3 Type selection sheet

Type Selection Sheet						
Machine name				Machine type		
Work condition		Axial load (kN)	Radial load (kN)	Tilting torque (kN.m)	Rotation speed (rpm)	Work time (%)
Load	Static Max.:					
	Test:					
					
	Dynamic Max.:					
	Test:					
	Overload:					
					
Vibration, impact level		Mild:	Moderate:	Severe:		
Use	Lifetime(h)					
	Installation method	Horizontal: seat type, hung type Vertical: Other:				
	Use method	Continuous: Interval: Pushing: Other:				
	Rotating parts	Outer ring: Inner ring:				
	Lubrication method	Grease: Oil: Other:				
	Seal	Machine setting: Bearing setting:				
	Bearing drive circumferential force	N				
	Environment condition	Humidity(%): Temperature (°C): Contamination:				
	Bearing working temperature	°C				

3. Installation and Maintenance

3.1 Assembly and Store

1) Slewing bearings shall be assembled and disassembled carefully.

2) Slewing bearings shall be kept horizontally in dry, ventilated and flat area. Separated from chemical materials and other corrosive matters when stored.

3) When several slewing bearings are overlapped with each other, at least three wooden pillows with equal height should be put between bearings along the circle direction, and the location of the upper and lower pillows should be identical.

4) Lift installation should apply ringbolt and be dealt with horizontally. Impact is forbidden, especially in radial direction.

5) ZWZ slewing bearings have already been anti-rusted when leaving the factory. In normal maintenance, the preventive period is one year. If expired the anti-rust term, and need to be stored for longer, the slewing bearing should be anti-rusted again.

3.2 Requirements for Assembling the Holders

1) There must be enough and equal radial and horizontal stability.

2) After welding assembled holders, they should have stress relief heat treatment, and should be machined reserving the fixed convex (concave) platform's flange plate, in order to avoid radial displacement.

3) The flatness (including the angular deviation with horizontal plane) of assembled holders should be controlled in limits (see Table 4).

Table 4 the flatness of mounting bracket

Raceway center diameter(mm)		Flatness (mm)		
Over	To	Single row four-point contact ball slewing bearing	Double-row ball slewing bearing	Cylindrical roller slewing bearing
-	1000	0.15	0.20	0.10
1000	1500	0.19	0.25	0.12
1500	2000	0.22	0.30	0.15
2000	2500	0.25	0.35	0.17
2500	4000	0.30	0.40	0.20
4000	6000	0.40	0.50	0.30
6000	8000	0.50	0.60	0.40

4) The maximum flatness of the assembled holder is allowed just once in 180°, several wave type peaks are forbidden that means increasing or decreasing uniformly among 0° ~ 90° ~ 180°, shown as Figure 4.

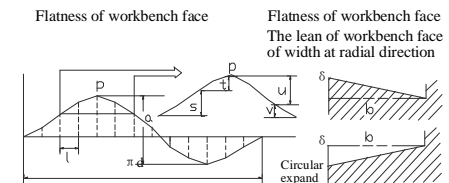

Figure 4 Flatness Requirement

Slewing Bearing

5*Assembled holders should have good rigidness. With the biggest permissible load, flexural deformation should be controlled in the range listed in Table 5.

Table 5 Maximum bending of holder flatness

Raceway center diameter(mm)	-1000	>1000 -1500	>1500 -2000	>2000 -2500	>2500 -3000	>3000 -3500	>3500 -4000	>4000 -4500	>4500 -5000	>5000 -5500	>5500 -6000	>6000 -7000	>7000 -8000
Maximum bending of holder flatness (mm)	0.6	0.8	1.0	1.3	1.6	2.0	2.5	3.0	3.6	4.2	4.8	5.8	7.0

3.3 Requirements for Bolt Preload

Preload should be assured when tightening the bolt, in normal maintenance, the preload should be 70% of the yield limit. Please see Table 6 for preload torque or preload.

Table 6 Bolt preload and preload torque

Bolt strength grade			8.8			10.9			12.9		
Yield limit N/mm ²			M≤16 640 M>16 660			940			1100		
Bolt diameter	Thread stress area mm ²	Thread cross-sectional area mm ²	Preload for bolt installation FM N	Theoretical preload torque MA Nm	Torsional moment NmM _t , =0.9MA	Preload for bolt installation FM N	Theoretical preload torque MA Nm	Torsional moment NmM _t , =0.9MA	Preload for bolt installation FM N	Theoretical preload torque MA Nm	Torsional moment NmM _t , =0.9MA
M5	14.2	12.7	6400	6.1	5.5	9300	8.9	8.0	10900	10.4	9.3
M6	20.1	17.9	9000	10.4	9.3	13200	15.5	13.9	15400	18	16.2
M8	36.6	32.8	16500	25	22.5	24200	37	33	28500	43	38
M10	58	52.3	26000	51	45	38500	75	67	45000	87	78
M12	84.3	76.2	38500	87	78	56000	120	117	66000	150	135
M14	115	105	53000	140	126	77000	205	184	90000	240	216
M16	157	144	72000	215	193	106000	310	279	124000	370	333
M18	193	175	91000	300	270	129000	430	387	151000	510	459
M20	245	225	117000	430	387	166000	620	558	194000	720	648
M22	303	282	146000	580	522	208000	830	747	243000	970	873
M24	353	324	168000	740	666	239000	1060	954	280000	1240	1116
M27	459	427	221000	1100	990	315000	1550	1395	370000	1850	1665
M30	561	519	270000	1500	1350	385000	2100	1890	450000	2500	2250
M33	694	647	335000			480000			560000		
M36	817	759	395000			560000			660000		
M39	976	913	475000			670000			790000		
M42	1120	1045	542000			772000			904000		
M45	1300	1224	635000	Need bolt hydraulic compact and tense device		905000	Need bolt hydraulic compact and tense device		1059000	Need bolt hydraulic compact and tense device	
M48	1470	1377	714000			1018000			1191000		
M52	1760	1652	857000			1221000			1429000		
M56	2030	1905	989000			1408000			1648000		
M60	2360	2227	1156000			1647000			1927000		

3.4 Bearing Assembly

Before assembling, the fitting surface and holder surface should be cleaned with no contamination, burr or any other matter.

3.4.1 Bearing Fixed Position

Slewing bearing rings have quenching soft zone, marked with "S", when assembling, the soft zone should be placed in none load area or not frequently loaded area.

3.4.2 Bolt Installation and Tightening

For the slewing bearings with gears, the none-gear ring should be firstly bolt fastened. Before installing the bolt, put a little lubrication oil in the bolt thread to make all the bolts have equal friction resistance. Fasten the bolts in the way of "star" program (see Figure 5), then we can get equal fasten effect in the circle. There are 3 circulates when tightening the bolt, each circulate respectively use 30%, 70% and 100% of the total tightening force. After each circulate, turn the ring several circles, then continue to the next circulate.

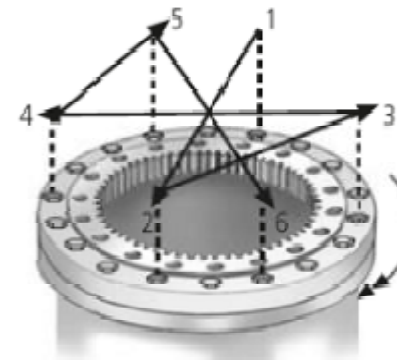

3.4.3 Gear vice lateral clearance adjustment

During installation for slewing bearing with gears, move the pinion to adjust the meshing

clearance. There is one biggest gear run-out point on the addendum (3 marked gears with green paint), meshing clearance δ of this place is 0.03~0.04m (m is module of the gear), see Figure 3-3 for inspection method. Turn the bearing more than circulate, check the meshing clearance of other parts and meshing clearance should not lower than δ .



Graph 6 side play inspection method

3.5 Bearing Lubrication and Maintenance

3.5.1 Bearing Relubricating

The slewing bearings have already been filled with special lubrication grease according to the working condition when leaving the factory. During rotation, grease should be supplemented, and the raceway should be filled with grease each time. When filling the grease, turn the bearing slowly to ensure the grease is filled equally. See Table 7 for lubrication interval.

Table 7 Re-lubrication period

Working condition	Lubrication interval
Running time h is less than 5 hours each week	Half a year
Running time h is more than 100 hours each week	Re-lubricate every 2 weeks
Running time h is between 5 hours and 100 hours each week	$T = -0.25h + 27$ T: Re-lubrication interval, week h: Running time each week, hour

3.5.2 Bolt Inspection

Preload for bolt must be ensured enough when slewing bearing is working. In the first 100 hours for the first bearing rotation, preload for bolt should be checked, and should be checked every 500 hours in following rotation.

Toothless Four-point Contact Ball Slewing Bearing

d 360~1540 mm

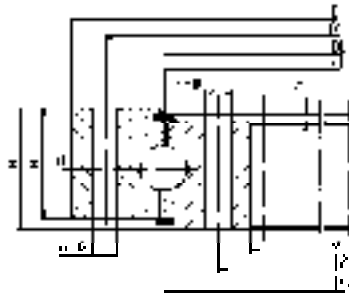

Note:

1. n1 is the amount of lubricating holes, customer can specify the position of lubricating hole according to using conditions.
2. N-φ can change to threaded hole, diameter of thread M, depth of thread 2M.
3. The product in this catalogue are standard products, please contact ZWZ if have other special requirements.

Bearing designation	Boundary Dimensions			Bolt hole dimensions				Structure dimensions						Mass kg
	D	d	H	D1	D2	n	f	D3	d1	H1	h	n1	M	
	mm			mm			mm						mm	
HSB300	360	240	38	340	260	12	9	298	302	31	7	3	8	12.5
HSB344	420	266	55	390	294	8	18	343	345	45	10	12	16	25.7
HSB345	410	285	40	385	305	12	11	344	346	35	5	1	10	16.8
HSB411	496	338	55	460	364	12	18.5	412	410	45	10	2	16	33.4
HSB413	485.521	342.9	55.88	457.2	368.3	12	14	410.5	457.2	44.45	11.43	0	11	28.9
HSB414	496	338	55	460	364	12	18.5	412	410	45	10	2	16	33.5
HSB441	520.344	355.6	50.8	492.125	387.35	12	14.275	438.65	444	50.8	0	0	13	40.1
HSB445	558	332	72	514	377	20	22	446	444	63	9	3	30	67
HSB489	562	396	60	538	440	24	13.5	487.5	491	50	10	4	12	44.9
HSB500	600	398	80	566	434	20	18	499	501	70	10	4	16	78.2
HSB500X1	600	398	70	566	434	20	18	499	501	70	10	4	16	80.1
HSB530	590	460	40	570	488	12	9	527	533	40	0	0	8	30.4
HSB530A	590	460	40	570	488	12	9	527	533	40	0	0	8	30.8
HSB560	662	458	80	626	494	20	18	561	558	70	10	4	16	87.5
HSB592	670	517	55	640	544	12	18	590	594	46	9	4	16	47
HSB630	732	528	80	696	564	24	18	631	628	70	10	4	16	97.7
HSB710	812	608	80	776	644	24	18	708	711	70	10	4	16	116
HSB710X1	812	608	80	776	644	24	18	720	699	70	10	4	16	119
HSB710XA	812	608	80	776	644	24	18	708	711	70	10	2	16	118
HSB724	819.15	628.65	50	781.05	666.75	18	14.275	722	726	50.8	0	0	13	78
HSB741	857	635	56	820	662	16	18	739	743	45.5	10.5	1	16	86
HSB800	922	678	100	878	722	30	22	801	798	90	10	6	20	200
HSB844	916	775	56	890	789	20	13.5	838	850	46	10	4	12	56.5
HSB844X1	916	772	56	890	798	40	14.7	842	846	44.5	11.5	0	12	58
HSB844K	916	775	56	890	798	20	13	842	846	46	10	4	12	60.8
HSB872.5	1060	670	189	1000	744	20	33	859.5	885.5	154	10	6	30	575
HSB900	1022	778	100	978	822	30	22	901	898	90	10	6	20	225
HSB980	1090	870	86	1050	910	44	22	978	982	72	14	4	20	163
HSB1000	1138	878	100	1078	922	36	22	998	1138	90	10	6	20	270
HSB1016	1117.6	914.4	50.8	1079.5	955.675	24	17.457	1014	1018	50.8	0	0	11	116
HSB1078	1244	881	160	1180	945	24	26	1130	1080	105	10	4	24	577
HSB1094	1166	1022	56	1140	1048	48	14	1092.5	1095.5	44.5	11.5	4	12	78.2
HSB1120	1242	998	100	1198	1042	36	22	1121	1118	90	10	6	20	271
HSB1250	1390	1110	110	1337	1163	40	26	1252	1248	100	10	5	24	399
HSB1270	1395.4	1144.45	88.9	1352.55	1187.45	30	17.475	1268	1272	79.25	9.65	0	11	282
HSB1400	1540	1260	110	1487	1313	40	26	1398	1402	100	10	5	24	423

Toothless Four-point Contact Ball Slewing Bearing



d 1660 ~ 3600 mm

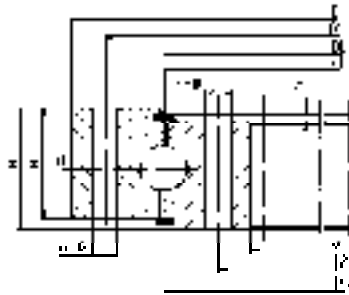

Note:

1. n1 is the amount of lubricating holes, customer can specify the position of lubricating hole according to using conditions.
2. N-φ can change to threaded hole, diameter of thread M, depth of thread 2M.
3. The product in this catalogue are standard products, please contact ZWZ if have other special requirements.

Bearing designation	Boundary Dimensions			Bolt hole dimensions				Structure dimensions						Mass kg
	D	d	H	D1	D2	n	f	D3	d1	H1	h	n1	M	
	mm			mm			mm	mm						
HSB1542	1660	1430	80	1620	1467	24	18	1538	1546	80	0	3	16	311
HSB1600	1740	1460	110	1687	1513	45	26	1602	1598	100	10	5	24	507
HSB1775	1927	1628	130	1875	1680	36	26	1807	1775	115	15	6	24	708
HSB1800	1940	1660	110	1887	1713	45	26	1798	1802	100	10	5	24	514
HSB1800X1	1940	1660	110	1887	1713	40	26	1790	1810	100	10	4	24	547
HSB2000	2178	1825	144	2110	1891	48	33	2040	1958	114	12	8	30	1012
HSB2021	2230	1805	165	2160	1880	36	33	2026	2016	150	15	4	30	1440
HSB2030	2230	1805	165	2160	1880	36	33	2035	2023	150	15	4	30	1440
HSB2135	2310	1905	180	2240	2030	36	23	2141	2131	160	20	4	20	1580
HSB2185	2360	1955	180	2290	2080	36	23	2190	2180	160	20	4	20	1620
HSB2220	2343. 15	2095. 5	87. 725	2289. 175	2133. 6	52	17. 463	2219. 2	2218. 3	73. 152	14. 573	0	11	442
HSB2240	2418	2065	144	2350	2131	48	33	2242	2238	132	12	4	30	1130
HSB2500	2678	2325	144	2610	2391	56	33	2498	2502	132	12	8	30	1270
HSB2645	2820	2474	225	2750	2540	60	32	2647	2643	160	65	12	30	1620
HSB2800	2978	2625	144	2910	2691	56	33	2802	2798	132	12	8	30	1484
HSB2944	3136	2751	135	3064	2823	60	33	2942	2946	125	28	6	30	1470
HSB3144	3271. 825	3017. 2	85. 725	3213. 1	3067. 05	60	17. 463	3141. 5	3143. 25	76. 2	15. 875	0	11	663
HSB3455	3600	3300	191	3560	3340	40	22	3455	3500	142	19	49	20	1740

Outer-tooth Four point Contact Ball Slewing Bearing

d 256~1584 mm

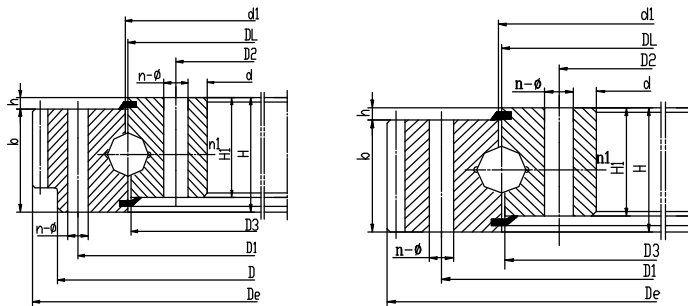

Note:

1. n1 is the amount of lubricating holes, customer can specify the position of lubricating hole according to using conditions.
2. N-φ can change to threaded hole, diameter of thread M, depth of thread 2M.
3. The product in this catalogue are standard products, please contact ZWZ if have other special requirements.

Bearing designation	Boundary Dimensions				Bolt hole dimensions				Structure dimensions						Parameters of gear				Mass kg
	De	D	d	H	D1	D2	n	φ	D3	d1	H1	h	n1	M	m	Z	b	x	
	mm				mm														
HSW186	256	234	135	38	216	154	16	11	185	187	30	8	4	10	4	162	26	0	6.76
HSW400	528	493	307	70	457	343	24	18	396	400	60	10	2	16	6	86	50	0	53.8
HSW450	576	507	357	70	507	393	24	18	450	450	60	10	2	16	6	94	50	0	61.7
HSW500	625	600	398	80	566	434	20	18	499	501	70	10	4	16	5	123	60	0	85.4
HSW500M	628.8	602	398	80	566	434	20	18	501	498	70	10	4	16	6	102	60	+0.5	89
HSW548	679.386	655	425	80	620	475	12	18	548	548	71	9	3	16	4.5	147	56	0	110
HSW560	688.8	662	458	80	626	494	20	18	558.5	561.5	70	10	4	16	6	112	46	+0.5	95.2
HSW630	768	732	528	80	696	564	24	18	630	631	70	10	4	16	6	126	60	0	114
HSW644	744	744	572	56	680	600	24	14	642.5	645.5	44.5	11.5	4	12	6	122	44.5	0	50.1
HSW710	850.8	812	608	80	776	644	24	18	708	711	70	10	4	16	6	139	60	+0.5	69.1
HSW800	924	812	710	67	845	744	8	11	799	801	58	9	4	10	6	152	58	0	121
HSW800X1	966.4	922	678	100	878	722	30	22	801	798	90	10	6	20	8	118	80	+0.5	215
HSW862	1026.5	975	745	111	940	784	20	23	860	864	90	21	4	20	8	120	80	0	242
HSW900	1062.4	1022	778	100	978	822	30	22	901	898	90	10	6	20	8	130	80	-0.5	239
HSW944	1046.4	1046.4	873.5	56	985	900	44	13.5	941	947	45.5	10.5	4	12	8	129	45.5	0	77
HSW980	1110.4	887	63	1039	922	30	18	981	979	54	9	5	18	8	136	54	+0.5	124	
HSW1000	1188	1000	878	100	1078	922	36	22	1000	1000	90	10	6	20	10	116	80	+0.5	288
HSW1000X1	1180	1120	876	90	1074	926	24	17.5	1000	1000	80	10	0	16	10	116	70	0	256
HSW1009	1180	1125	895	100	1085	935	10	22	1004.5	1008.5	85	15	4	20	10	116	75	0	262
HSW1052.5	1192.626	1160	930	80	1125	980	28	18	1052.5	1052.5	70	10	4	16	5	231	55	0	210
HSW1055	1200	1200	905	90	1116	945	30	22	1056.5	1053.5	71	19	6	20	10	118	71	0.0136	227
HSW1055X1	1200	1200	905	90	1116	945	30	22	1056.5	1053.5	71	19	6	20	10	118	71	0	227
HSW1094	1198.1	1198.1	1022	56	1135	1048	48	14	1092.5	1095.5	44.5	11.5	4	12	8	148	44.5	0	91.6
HSW1120	1278	1013	79	1183	1057	30	22	1121	1119	54	9	5	20	10	125	70	+0.5	182	
HSW1120R	1300	1240	996	90	1194	1046	28	24	1121	1118	80	10	4	22	10	129	70	-0.5	272
HSW1120RM	1308	1240	996	90	1194	1046	28	24	1121	1118	80	10	4	22	12	108	70	-0.5	272
HSW1148	1314.1	1314.1	1040	80	1220	1080	30	17.5	1139	1157	70	10	0	16	10	125	70	0	225
HSW1162	1320	1320	1045	93	1236	1084	36	21	1166.5	1158.5	77	16	4	20	10	130	77	0	276
HSW1180	1338	1338	1068	79	1248	1112	36	22	1181	1178	63	9	6	22	10	131	70	+0.5	227
HSW1120	1435.9	1365	1075	120	1310	1130	36	24	1221	1218	105	15	6	22	12	116	90	+1	488
HSW1250	1408	1143	79	1313	1187	36	22	1251	1249	54	9	6	22	10	138	70	+0.5	221	
HSW1250R	1430	1370	1126	90	1324	1176	32	24	1251	1248	80	10	4	24	10	142	70	-0.5	302
HSW1250RM	1440	1370	1126	90	1324	1176	32	24	1251	1248	80	10	4	24	12	119	70	-0.5	309
HSW1278	1428.266	1391	1150	80	1356	1200	32	18	1278	1278	70	8	4	16	6	228	55	0	261
HSW1320	1497.6	1208	89	1388	1252	42	22	1321	1318	63	9	6	20	12	122	80	+0.5	298	
HSW1358	1510	1510	1215	90	1426	1255	24	22	1354	1362	71	19	6	20	10	149	71	0	256
HSW1400	1584	1520	1276	90	1474	1326	36	24	1401	1398	80	10	6	22	12	131	70	-0.5	337

Outer-tooth Four point Contact Ball Slewing Bearing

d 1596 ~ 3972 mm

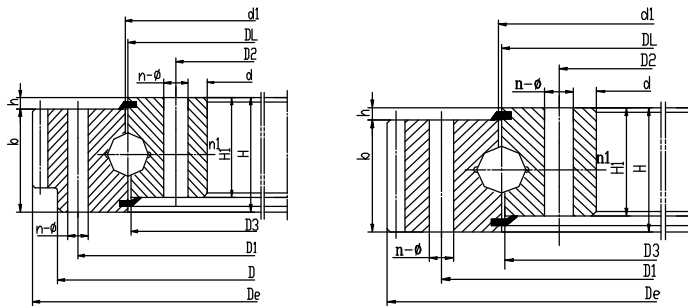

Note:

1. n1 is the amount of lubricating holes, customer can specify the position of lubricating hole according to using conditions.
2. N-φ can change to threaded hole, diameter of thread M, depth of thread 2M.
3. The product in this catalogue are standard products, please contact ZWZ if have other special requirements.

Bearing designation	Boundary Dimensions				Bolt hole dimensions				Structure dimensions						Parameters of gear				Mass kg
	De	D	d	H	D1	D2	n	φ	D3	d1	H1	h	n1	M	m	Z	b	x	
	mm				mm														
HSW1400M	1596	1520	1276	90	1474	1326	36	24	1401	1398	80	10	6	22	14	113	70	-0.5	347
HSW1400R	1608	1540	1258	102	1486	1314	36	26	1401	1398	90	12	6	24	12	133	80	-0.5	448
HSW1452	1600	1600	1305	90	1516	1345	48	22	1455	1454	71	19	6	20	10	158	71	0	253
HSW1452X1	1600	1600	1305	90	1516	1345	48	22	1456.5	1453.5	71	19	6	20	10	158	71	0	262
HSW1454	1600	1550	1305	102	1505	1345	24	22	1450	1458	78	17	3	20	10	158	65	0	282
HSW1500	1677.6		1388	89	1568	1432	48	22	1501	1498	63	9	6	20	12	137	80	+0.5	338
HSW1520	1690	1645	1390	91	1600	1440	22	20	1500	1521.5	91	14	4	18	5	336	47	0	347
HSW1540	1791.1	1720	1360	140	1660	1420	42	26	1540	1540	122	18	6	24	14	124	110	+1.15	926
HSW1600X	1803.2		1466	94	1682	1518	40	26	1601	1598	81	9	8	24	14	126	85	+0.5	479
HSW1600	1812	1740	1458	102	1686	1514	40	26	1601	1598	90	12	5	24	12	150	80	-0.5	528
HSW1600M	1820	1740	1458	102	1686	1514	40	26	1601	1598	90	12	5	24	14	129	80	-0.5	534
HSW1600R	1817.2	1740	1460	110	1687	1513	45	26	1602	1598	100	10	5	24	14	127	90	+0.5	584
HSW1618	1845	1845	1506	95	1728	1550	40	22	1617	1620	86	9	10	20	14	129	67	+0.5	425
HSW1800	1934.47	1902	1680	105	1848	1736	24	18	1801	1803	90	15	6	16	6	308	90	0	450
HSW1800M	2032	1940	1658	102	1886	1714	44	26	1802	1798	90	12	4	24	16	126	80	0.5	607
HSW1800R	2013.2	1940	1660	110	1887	1713	45	26	1802	1798	100	10	5	24	14	141	90	+0.5	652
HSW1824	2013.2	2013.2	1705	122	1896	1749	48	22	1824	1821	80	10	24	20	14	141	112	0.5	566
HSW1900	2139.2		1729	109	2005	1795	36	33	1902	1898	99	9	9	30	14	150	100	+0.5	820
HSW1958	2152.81	2085	1820	90	2045	1870	36	18	1958	1958	70	20	4	16	8	258	60	0	496
HSW2000	2195.2	2129	1877	111	2068	1927	40	22	2001	2003	74	34	10	20	14	154	102	+0.5	599
HSW2000M	2264.4	2178	1825	144	2110	1891	48	33	2002	1998	132	12	8	30	18	123	120	+0.5	1169
HSW2028	2192.041	2150	1880	105	2110	1945	48	18	2026	2030	90	15	6	16	7.5	270	80	0	635
HSW2100	2263.047	2220	1970	105	2180	2020	36	22	2098	2102	90	15	6	20	8	270	80	0	700
HSW2130	2380.8		1959	109	2235	2025	48	33	2132	2128	99	9	8	30	16	146	100	+0.5	931
HSW2240	2382	2342	2130	80	2306	2174	48	18	2238	2242	70	10	6	16	6	395	30	0	388
HSW2240M	2498.4	2418	2065	144	2350	2131	48	33	2242	2238	132	12	8	30	18	136	120	+0.5	1294
HSW2355	2624.4	2541	2184	130	2460	2250	76	33	2357	2353	121	9	12	30	18	143	120	+0.5	1211
HSW2425	2568	2519	2325	72	2490	2365	40	18	2425	2425	63	9	8	16	10	255	55	0	450
HSW2500	2754	2660	2325	144	2610	2391	36	33	2498	2502	132	12	6	30	18	151	120	0	1462
HSW2500M	2776	2678	2325	144	2610	2391	56	33	2502	2498	132	12	8	30	20	136	120	+0.5	1509
HSW2645	2892.8		2474	109	2750	2540	60	33	2647	2643	99	9	12	30	16	178	100	+0.5	1142
HSW2800	3074.4	2978	2625	144	2910	2691	56	33	2802	2798	132	12	8	30	18	168	120	+0.5	1696
HSW2800M	3076	2978	2625	144	2910	2691	56	33	2802	2798	132	12	8	30	20	151	120	+0.5	1696
HSW3124	3456	3340	2940	183	3254	2994	72	26	3124	3124	133	43	20	24	24	141	110	+0.5	2280
HSW3150	3476	3376	2922	174	3286	3014	56	45	3152	3147	162	12	8	42	20	171	150	+0.5	2873
HSW3150M	3471.6	3376	2922	174	3286	3014	56	45	3152	3147	162	12	8	42	22	155	150	+0.5	2873
HSW3600	3972	3972	3400	220	3740	3460	72	32	3600	3604	205	60	20	30	24	163	160	0.25	3830

Inner-tooth Four point Contact Ball Slewing Bearing

d 300~1224 mm

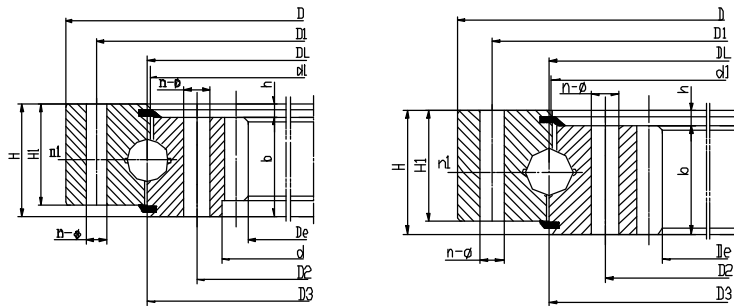

Note:

1. n1 is the amount of lubricating holes, customer can specify the position of lubricating hole according to using conditions.
2. N-φ can change to threaded hole, diameter of thread M, depth of thread 2M.
3. The product in this catalogue are standard products, please contact ZWZ if have other special requirements.

Bearing designation	Boundary Dimensions				Bolt hole dimensions				Structure dimensions						Parameters of gear				Mass kg
	De	D	d	H	D1	D2	n	φ	D3	d1	H1	h	n1	M	m	Z	b	x	
	mm				mm														
HSN400	300	475		55	448	352	16	13.5	401	339	46	9	2	14	5	61	46	+0.5	33
HSN450	345	531		55	500	400	16	15.5	451	449	46	9	2	14	5	70	46	+0.5	38
HSN480	380	573	400	55	538	420	16	16	478.5	481.5	45	5	2	14	4	96	45	+0.5	49
HSN489	388	562	408	60	538	440	24	13.5	487.5	490.5	50	10	12	22	4	99	43	0	44.9
HSN500	367	602	398	80	566	434	20	18	501	498	70	10	4	16	5	74	60	+0.5	90
HSN500M	368.4	602	398	80	566	434	20	18	501	498	70	10	4	16	6	62	60	+0.5	90
HSN560	450	641		55	610	510	20	15.5	561	559	46	9	4	14	6	76	46	+0.5	51
HSN560R	427	662	458	80	626	494	20	18	561	558	70	10	4	16	5	86	60	+0.5	102
HSN560RM	428.4	662	458	80	626	494	20	18	561	558	70	10	4	16	6	72	60	+0.5	102
HSN567.5	471.5	640	496	55	615	520	20	13.5	567.5	567.5	45	10	1	12	5	96	44.5	0.15	49.2
HSN630	494.4	732	528	80	696	564	24	18	631	628	70	10	4	16	6	83	60	+0.5	116
HSN630M	491.2	732	528	80	696	564	24	18	631	628	70	10	4	16	8	62	60	+0.5	116
HSN710	594	797		55	762	658	24	18	711	709	46	9	4	16	6	100	46	+0.5	68
HSN710R	572.4	812	608	80	776	644	24	18	711	708	70	10	4	16	6	96	60	+0.5	132
HSN720	582	820	620	80	780	660	18	18	721	719	70	10	12	16	6	99	60	0	125
HSN800	635.2	922	678	100	878	722	30	22	801	798	90	10	6	20	8	80	80	+0.5	224
HSN800M	634	922	678	100	878	722	30	22	801	798	90	10	6	20	10	64	80	+0.5	224
HSN886	752	980		63	944	827	36	18	887	885	54	9	4	16	8	95	54	+0.5	111
HSN900	739.2	1022	778	100	978	822	30	22	901	898	90	10	6	20	8	93	80	+0.5	252
HSN900M	734	1022	778	100	978	822	30	22	901	898	90	10	6	20	10	74	80	+0.5	252
HSN1000	824	1122	878	100	1078	922	36	22	1001	998	90	10	6	20	10	83	80	+0.5	292
HSN1000M	820.8	1122	878	100	1078	922	36	22	1001	998	90	10	6	20	12	69	80	+0.5	292
HSN1077	930	1169		63	1134	1017	36	18	1078	1076	54	9	6	16	10	94	54	+0.5	140
HSN1050	888.6	1170	920	98	1125	975	40	22	1040	1052	80	10	2	20	8	150	60	0	248
HSN1086S	920	1200		90	1158	940	12	20	1086	1090	80	10	4	18	10	94	80	0	320
HSN1094C	984	1166		56	1140	1055	60	13.5	1095.5	1092.5	45	11	4	12	8	125	45	0	90.5
HSN1120	960	1232		79	1188	1052	36	22	1121	1118	63	9	6	20	10	97	70	+0.5	206
HSN1120R	944	1242	998	100	1198	1042	36	22	1121	1118	90	10	6	20	10	95	80	+0.5	333
HSN1120RM	940.8	1242	998	100	1198	1042	36	22	1121	1118	90	10	6	20	12	79	80	+0.5	333
HSN1220	1017.3	1365		120	1310	1130	36	24	1219	1221	105	15	6	22	12	86	105	+0.35	474
HSN1225	1052	1360		98	1303	1147	40	26	1223	1227	80	10	4	24	10	106	88	+0.5	320
HSN1250	1090	1362		79	1318	1182	40	22	1251	1248	63	9	8	20	10	110	70	+0.5	231
HSN1250R	1048.8	1390	1110	110	1337	1163	40	26	1252	1248	100	10	5	24	12	88	90	+0.5	467
HSN1250RM	1041.6	1390	1110	110	1337	1163	40	26	1252	1248	100	10	5	24	14	75	90	+0.5	467
HSN1535	1278	1695		165	1636	1434	40	30	1533	1537	125	25	4	27	18	72	140	+0.5	930
HSN1400	1224	1512		89	1468	1332	44	22	1401	1398	63	9	11	20	12	103	80	+0.5	296

Inner-tooth Four point Contact Ball Slewing Bearing

d 1192.8 ~ 3564 mm

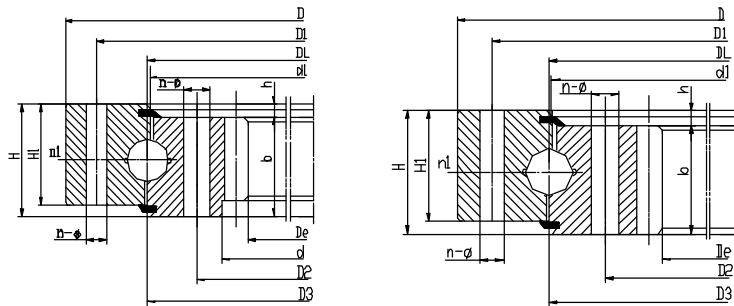

Note:

1. n1 is the amount of lubricating holes, customer can specify the position of lubricating hole according to using conditions.
2. N-φ can change to threaded hole, diameter of thread M, depth of thread 2M.
3. The product in this catalogue are standard products, please contact ZWZ if have other special requirements.

Bearing designation	Boundary Dimensions				Bolt hole dimensions				Structure dimensions						Parameters of gear				Mass kg
	De	D	d	H	D1	D2	n	φ	D3	d1	H1	h	n1	M	m	Z	b	x	
	mm				mm				mm										
HSN1400R	1192.8	1540	1260	110	1487	1313	40	26	1402	1398	100	10	5	24	12	100	90	+0.5	529
HSN1400RM	1195.6	1540	1260	110	1487	1313	40	26	1402	1398	100	10	5	24	14	86	90	+0.5	529
HSN1405	1235	1526		122	1481	1358	40	26	1403	1407	97	12	3	24	14	90	110	0	434
HSN1500	1308	1634		94	1582	1418	40	26	1501	1498	81	9	8	24	12	110	85	+0.5	410
HSN1600	1428	1712		89	1668	1532	48	22	1601	1598	63	9	8	20	12	120	80	+0.5	334
HSN1600R	1391.6	1740	1460	110	1687	1513	45	26	1602	1598	100	10	5	24	14	100	90	+0.5	607
HSN1600RM	1382.4	1740	1460	110	1687	1513	45	26	1602	1598	100	10	5	24	16	87	90	+0.5	620
HSN1700	1498	1834		94	1782	1618	44	26	1701	1698	81	9	11	24	14	108	85	+0.5	475
HSN1728	1500.8	1905	1580	117	1810	1640	30	22/26			95	9	10	20/24	14	108	98	+0.5	701
HSN1800	1573.6	1940	1660	110	1887	1713	50	26	1798	1802	100	10	5	24	14	113	90	+0.5	649
HSN1895	1830	1960		115	1865	1925	36/34		1990	1825	64	30	24	5	368	39	0	258	
HSN2000	1728	2178	1825	144	2110	1891	48	33	1998	2002	132	12	12	30	16	109	120	+0.5	1176
HSN2070	1910.2	2260		140	2180	1995	48		2066	2074	100	40	6	20	10	192	100	+0.5	862
HSN2211	2032	2335		124	2280	2144	64	22	2208	2214	80	20	6	20	14	147	100	0	633
HSN2240	1984	2411		109	2345	2135	48	33	2242	2238	99	9	8	30	16	125	100	+0.5	961
HSN2240R	1990.4	2418	2065	144	2350	2131	48	33	2242	2238	132	12	8	30	16	125	120	+0.5	1393
HSN2240RM	1987.2	2418	2065	144	2350	2131	48	33	2242	2238	132	12	8	30	18	111	120	+0.5	1393
HSN2249	2023.4	2410		132	2358	2140	36	22	2246	2252	122	9	4	20	14	146	123	0.245	1115
HSN2335	2230	2404	2256	120	2270	2410	42/40		2470	2231.4	74	18	20	5	448	45	0	516	
HSN2490	2240	2661		109	2595	2385	54	33	2492	2488	99	9	9	30	16	141	100	+0.5	1053
HSN2500	2239.2	2678	2325	144	2610	2391	56	33	2502	2498	132	12	8	30	18	125	120	+0.5	1580
HSN2500M	2228	2678	2325	144	2610	2391	56	33	2502	2498	132	12	8	30	20	112	120	+0.5	1580
HSN2660	2323	2880		178	2810	2510	60	39	2664	2656	161	17	4	36	18	131	161	0	2373
HSN2675	2590	2750	2616	119	2634	2744	48/38		2784	2600	72	26	3	20	5	520	45	0	431
HSN2786	2544.38	2942	2622	155	2890	2683	48	26	2784	2789	125	30	24	24	16	160	115	+0.5	1410
HSN2796	2515.2	3000	2590	152	2922	2670	72	39	2794	2798	134	20	12	36	16	158	131	+0.5	2033
HSN2800	2502	2978	2625	144	2910	2691	60		2809	2791	132	12	8	30	18	141	117	0	1776
HSN2840	2622.4	2990	2735	160	2945	2770	48	23	2835	2820	135	5	8	20	22	121	144	0	1442
HSN3150	2828	3376	2922	174	3286	3014	56	45	3152	3147	162	12	8	42	20	142	150	+0.5	2840
HSN3150M	2824.8	3376	2922	174	3286	3014	56	45	3152	3147	162	12	8	42	22	129	150	+0.5	2840
HSN3803	3564	3939	3651	105	3895	3711	60	22	3807	3799	82	10	15	20	18	199	90	+0.5	1430

Toothless Double-row Angular Contact Ball Slewing Bearing

d 616~4778 mm

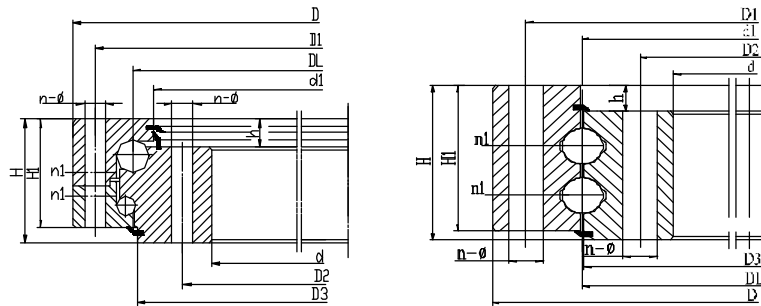

Note:

1. n1 is the amount of lubricating holes, customer can specify the position of lubricating hole according to using conditions.
2. N-φ can change to threaded hole, diameter of thread M, depth of thread 2M.
3. The product in this catalogue are standard products, please contact ZWZ if have other special requirements.

Bearing designation	Boundary Dimensions			Bolt hole dimensions				Structure dimensions						Mass kg
	D	d	H	D1	D2	n	φ	D3	d1	H1	h	n1	M	
	mm			mm										
HSB500D	616	384	106	580	420	20	18	482	477	96	26	4	16	121
HSB560D	676	444	106	640	480	20	18	543	537	96	26	4	16	136
HSB630D	746	514	106	710	550	24	18	613	607	96	26	4	16	152
HSB710D	826	594	106	790	630	24	18	692	687	96	26	4	16	172
HSB800D	942	658	124	898	702	30	22	777	771	114	29	6	20	284
HSB900D	1042	758	124	998	802	30	22	877	871	114	29	6	20	316
HSB1000D	1142	858	124	1098	902	36	22	977	971	114	29	6	20	349
HSB1120D	1262	978	124	1218	1022	36	22	1097	1091	114	29	6	20	394
HSB1250D	1426	1074	160	1374	1126	40	26	1215	1214	150	39	5	24	709
HSB1400D	1576	1224	160	1524	1272	40	26	1365	1364	150	39	5	24	787
HSB1600D	1776	1424	160	1724	1476	45	26	1565	1564	150	39	5	24	899
HSB1783D	1959	1606	166	1893	1672	60	33	1781	1785	158	26	10	30	974
HSB1800D	1976	1624	160	1924	1676	45	26	1765	1764	150	39	5	24	1018
HSB2000D	2215	1785	190	2149	1851	48	33	1965	1962	178	47	8	30	1586
HSB2240D	2455	2025	190	2389	2091	48	33	2206	2202	178	47	8	30	1789
HSB2500D	2715	2285	190	2649	2351	56	33	2465	2462	178	47	8	30	1990
HSB2800D	3015	2585	190	2949	2651	56	33	2765	2762	178	47	8	30	2243
HSB3150D	3428	2872	226	3338	2962	56	45	3104	3102	214	56	8	42	3762
HSB3550D	3828	3272	226	3738	3362	56	45	3504	3502	214	56	8	42	4272
HSB4000D	4278	3722	226	4188	3812	60	45	3954	3952	214	56	10	42	4828
HSB4500D	4778	4222	226	4688	4312	60	45	4454	4452	214	56	10	42	5465

Outer-tooth Double-row Angular Contact Slewing Bearing

d 644 ~ 2552.4 mm

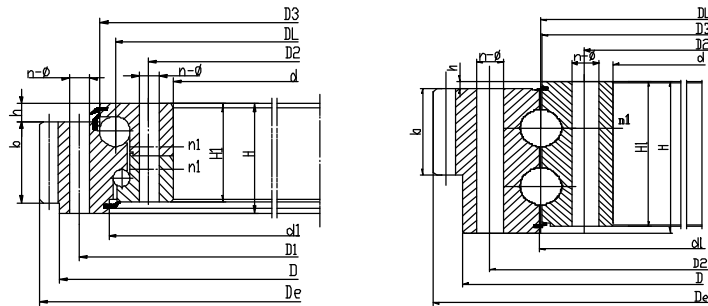

Note:

1. n1 is the amount of lubricating holes, customer can specify the position of lubricating hole according to using conditions.
2. N-φ can change to threaded hole, diameter of thread M, depth of thread 2M.
3. The product in this catalogue are standard products, please contact ZWZ if have other special requirements.

Bearing designation	Boundary Dimensions				Bolt hole dimensions				Structure dimensions						Parameters of gear				Mass kg
	De	D	d	H	D1	D2	n	φ	D3	d1	H1	h	n1	M	m	Z	b	x	
	mm				mm				mm										
HSW500D	644	616	384	106	580	420	20	18	523	518	96	26	4	16	5	126	60	+0.5	130
HSW500DM	646.8	616	384	106	580	420	20	18	523	518	96	26	4	16	6	105	60	+0.5	130
HSW560D	704	676	444	106	640	480	20	18	583	578	96	26	4	16	5	138	60	+0.5	146
HSW560DM	706.8	676	444	106	640	480	20	18	583	578	96	26	4	16	6	115	60	+0.5	147
HSW630D	790.8	746	514	106	710	550	24	18	653	648	96	26	4	16	6	129	60	+0.5	173
HSW630DM	790.4	746	514	106	710	550	24	18	653	648	96	26	4	16	8	96	60	+0.5	170
HSW710D	862.8	826	594	106	790	630	24	18	733	728	96	26	4	16	6	141	60	+0.5	190
HSW710DM	862.4	826	594	106	790	630	24	18	733	728	96	26	4	16	8	105	60	+0.5	187
HSW800D	982.4	942	658	124	898	702	30	22	829	823	114	29	6	20	8	120	80	+0.5	305
HSW800DM	988	942	658	124	898	702	30	22	829	823	114	29	6	20	10	96	80	+0.5	307
HSW900D	1086.4	1042	758	124	998	802	30	22	929	923	114	29	6	20	8	133	80	+0.5	349
HSW900DM	1088	1042	758	124	998	802	30	22	929	923	114	29	6	20	10	106	80	+0.5	348
HSW1000D	1198	1142	858	124	1098	902	36	22	1029	1023	114	29	6	20	10	117	80	+0.5	396
HSW1000DM	1197.6	1142	858	124	1098	902	36	22	1029	1023	114	29	6	20	12	97	80	+0.5	391
HSW1120D	1318	1262	978	124	1218	1022	36	22	1148	1143	114	29	6	20	10	129	80	+0.5	445
HSW1120DM	1317.6	1262	978	124	1218	1022	36	22	1148	1143	114	29	6	20	12	107	80	+0.5	439
HSW1250D	1497.6	1426	1074	160	1374	1126	40	26	1286	1282	150	39	5	24	12	122	90	+0.5	740
HSW1250DM	1495.2	1426	1074	160	1374	1126	40	26	1286	1282	150	39	5	24	14	104	90	+0.5	774
HSW1400D	1641.6	1576	1224	160	1524	1272	40	26	1440	1423	150	39	5	24	12	134	90	+0.5	803
HSW1400DM	1649.2	1576	1224	160	1524	1272	40	26	1436	1432	150	39	5	24	14	115	90	+0.5	878
HSW1600D	1845.2	1776	1424	160	1724	1476	45	26	1636	1635	150	39	5	24	14	129	90	+0.5	995
HSW1600DM	1852.8	1776	1424	160	1724	1476	45	26	1636	1635	150	39	5	24	16	113	90	+0.5	1003
HSW1800D	2060.8	1976	1624	160	1924	1676	45	26	1840	1823	150	39	5	24	16	126	90	+0.5	1208
HSW1800DM	2060.8	1976	1624	160	1924	1676	45	26	1836	1835	150	39	5	24	16	126	90	+0.5	1151
HSW2000D	2300.8	2215	1785	190	2149	1851	48	33	2038	2035	178	47	8	30	16	141	120	+0.5	1794
HSW2000DM	2300.4	2215	1785	190	2149	1851	48	33	2038	2035	178	47	8	30	18	125	120	+0.5	1780
HSW2240D	2540.8	2455	2025	190	2389	2091	48	33	2278	2275	178	47	8	30	16	156	120	+0.5	2017
HSW2240DM	2552.4	2455	2025	190	2389	2091	48	33	2278	2275	178	47	8	30	18	139	120	+0.5	2048

Outer-tooth Double-row Angular Contact Slewing Bearing

d 2804.4 ~ 4895 mm

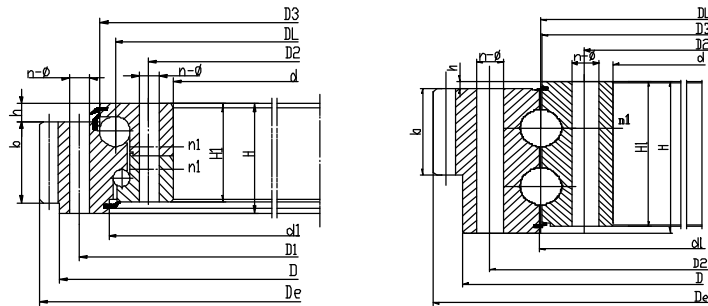

Note:

1. n1 is the amount of lubricating holes, customer can specify the position of lubricating hole according to using conditions.
2. N-φ can change to threaded hole, diameter of thread M, depth of thread 2M.
3. The product in this catalogue are standard products, please contact ZWZ if have other special requirements.

Bearing designation	Boundary Dimensions				Bolt hole dimensions				Structure dimensions						Parameters of gear				Mass kg
	De	D	d	H	D1	D2	n	φ	D3	d1	H1	h	n1	M	m	Z	b mm	x	
	mm				mm			mm	mm										
HSW2500D	2804.4	2715	2285	190	2649	2351	56	33	2538	2532	178	47	8	30	18	153	120	+0.5	2246
HSW2500DM	2816	2715	2285	190	2649	2351	56	33	2538	2532	178	47	8	30	20	138	120	+0.5	2280
HSW2738D	3004	2930	2559	208	2864	2625	36	33	2736	2740	199	9	12	30	16	185	128	+0.5	2480
HSW2800D	3110.4	3015	2585	190	2949	2651	56	33	2838	2832	178	47	8	30	18	170	120	+0.5	2553
HSW2800DM	3116	3015	2585	190	2949	2651	56	33	2838	2832	178	47	8	30	20	153	120	+0.5	2563
HSW3150D	3536	3428	2872	226	3338	2962	56	45	3198	3196	214	56	8	42	20	174	150	+0.5	4428
HSW3150DM	3537.6	3428	2872	226	3338	2962	56	45	3198	3196	214	56	8	42	22	158	150	+0.5	4414
HSW3400D	3700	3605	3240	214	3530	3295	52	33	3436	3440	178	44	8	30	20	183	160	0	2770
HSW3550D	3936	3828	3272	226	3738	3362	56	45	3598	3596	214	56	8	42	20	194	150	+0.5	5012
HSW3550DM	3933.6	3828	3272	226	3738	3362	56	45	3598	3596	214	56	8	42	22	176	150	+0.5	4967
HSW4000DM	4395.6	4278	3722	226	4188	3812	60	45	4048	4046	214	56	10	42	22	197	150	+0.5	5706
HSW4000D	4395	4278	3722	226	4188	3812	60	45	4048	4046	214	56	10	42	25	173	150	+0.5	5656
HSW4500D	4867.2	4754	4256	200	4642	4358	84	39	4502	4498	190	10	7	36	24	200	180	+0.5	5380
HSW4500DM	4895	4778	4222	226	4688	4312	60	45	4548	4546	214	56	10	42	25	193	150	+0.5	6385

Inner-tooth Double-row Angular Contact Ball Slewing Bearing

d 257 ~ 1933.2 mm

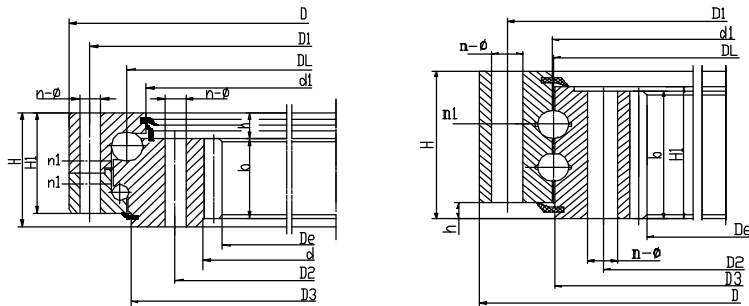

Note:

1. n1 is the amount of lubricating holes, customer can specify the position of lubricating hole according to using conditions.
2. N-φ can change to threaded hole, diameter of thread M, depth of thread 2M.
3. The product in this catalogue are standard products, please contact ZWZ if have other special requirements.

Bearing designation	Boundary Dimensions				Bolt hole dimensions				Structure dimensions						Parameters of gear				Mass kg
	De	D	d	H	D1	D2	n	φ	D3	d1	H1	h	n1	M	m	Z	b	x	
	mm				mm														
HSN500D	257	616	384	106	580	420	20	18	482	477	96	26	4	16	5	72	60	+0.5	126
HSN500DM	350.4	616	384	106	580	420	20	18	482	477	96	26	4	16	6	59	60	+0.5	128
HSN560D	417	676	444	106	640	480	20	18	542	537	96	26	4	16	5	84	60	+0.5	143
HSN560DM	410.4	676	444	106	640	480	20	18	542	537	96	26	4	16	6	69	60	+0.5	144
HSN630D	482.4	746	514	106	710	550	24	18	612	607	96	26	4	16	6	81	60	+0.5	160
HSN630DM	475.2	746	514	106	710	550	24	18	612	607	96	26	4	16	8	60	60	+0.5	162
HSN710D	560.4	826	594	106	790	630	24	18	692	687	96	26	4	16	6	94	60	+0.5	183
HSN710DM	555.2	826	594	106	790	630	24	18	692	687	96	26	4	16	8	70	60	+0.5	184
HSN762D	640	850	640	93	820	705	36	17.5	760	764	83	10	4	16	8	81	83	0.5	140
HSN800D	619.2	942	658	124	898	702	30	22	777	771	114	29	6	20	8	78	80	+0.5	300
HSN800DM	614	942	658	124	898	702	30	22	777	771	114	29	6	20	10	62	80	+0.5	301
HSN900D	715.2	1042	758	124	998	802	30	22	877	871	114	29	6	20	8	90	80	+0.5	337
HSN900DM	714	1042	758	124	998	802	30	22	877	871	114	29	6	20	10	72	80	+0.5	335
HSN1000D	814	1142	858	124	1098	902	36	22	977	971	114	29	6	20	10	82	80	+0.5	371
HSN1000DM	796.8	1142	858	124	1098	902	36	22	977	971	114	29	6	20	12	67	80	+0.5	383
HSN1120D	924	1262	978	124	1218	1022	36	22	1097	1091	114	29	6	20	10	93	80	+0.5	429
HSN1120DM	916.8	1262	978	124	1218	1022	36	22	1097	1091	114	29	6	20	12	77	80	+0.5	432
HSN1250D	1012.8	1426	1074	160	1374	1126	40	26	1215	1214	150	39	5	24	12	85	90	+0.5	746
HSN1250DM	1013.6	1426	1074	160	1374	1126	40	26	1215	1214	150	39	5	24	14	73	90	+0.5	741
HSN1400D	1156.8	1576	1224	160	1524	1272	40	26	1365	1364	150	39	5	24	12	97	90	+0.5	850
HSN1400DM	1153.6	1576	1224	160	1524	1272	40	26	1365	1364	150	39	5	24	14	83	90	+0.5	850
HSN1600D	1349.6	1776	1424	160	1724	1476	45	26	1565	1564	150	39	5	24	14	97	90	+0.5	979
HSN1600DM	1350.4	1776	1424	160	1724	1476	45	26	1565	1564	150	39	5	24	16	85	90	+0.5	972
HSN1800D	1545.6	1976	1624	160	1924	1676	45	26	1765	1764	150	39	5	24	14	111	90	+0.5	1117
HSN1800DM	1542.4	1976	1624	160	1924	1676	45	26	1765	1764	150	39	5	24	16	97	90	+0.5	1116
HSN2000D	1702.4	2215	1785	190	2149	1851	48	33	1965	1962	178	47	8	30	16	107	120	+0.5	1733
HSN2000DM	1699.2	2215	1785	190	2149	1851	48	33	1965	1962	178	47	8	30	18	95	120	+0.5	1732
HSN2240D	1942.4	2455	2025	190	2389	2091	48	33	2206	2202	178	47	8	30	16	122	120	+0.5	1956
HSN2240DM	1933.2	2455	2025	190	2389	2091	48	33	2206	2202	178	47	8	30	18	108	120	+0.5	1973

Inner-tooth Double-row Angular Contact Ball Slewing Bearing

d 2203.2 ~ 4110 mm

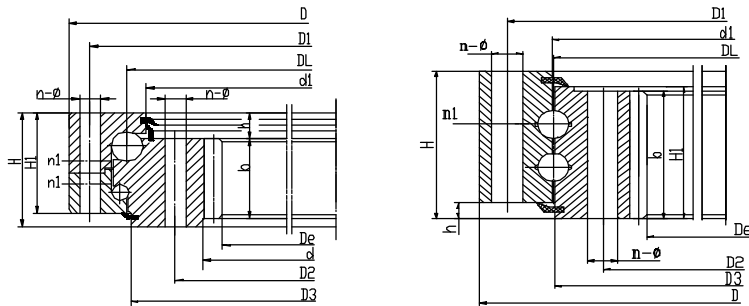

Note:

1. n1 is the amount of lubricating holes, customer can specify the position of lubricating hole according to using conditions.
2. N-φ can change to threaded hole, diameter of thread M, depth of thread 2M.
3. The product in this catalogue are standard products, please contact ZWZ if have other special requirements.

Bearing designation	Boundary Dimensions				Bolt hole dimensions				Structure dimensions						Parameters of gear				Mass kg
	De	D	d	H	D1	D2	n	φ	D3	d1	H1	h	n1	M	m	Z	b	x	
	mm				mm														
HSN2500D	2203.2	2715	2285	190	2649	2351	56	33	2465	2462	178	47	8	30	18	123	120	+0.5	2164
HSN2500DM	2188	2715	2285	190	2649	2351	56	33	2465	2462	178	47	8	30	20	110	120	+0.5	2204
HSN2800D	2491.2	3015	2585	190	2949	2651	56	33	2765	2762	178	47	8	30	18	139	120	+0.5	2486
HSN2800DM	2488	3015	2585	190	2949	2651	56	33	2765	2762	178	47	8	30	20	125	120	+0.5	2485
HSN3150D	2768	3428	2872	226	3338	2962	56	45	3104	3102	214	56	8	42	20	139	150	+0.5	4137
HSN3150DM	2758.8	3428	2872	226	3338	2962	56	45	3104	3102	214	56	8	42	22	126	150	+0.5	4167
HSN3310D	3000	3500	240	240	3435	3190	88	37	3255	3262	214	50	16	33	24	126	190	+0.5	3380
HSN3550D	3168	3828	3272	226	3738	3362	56	45	3504	3502	214	56	8	42	20	159	150	+0.5	4700
HSN3550DM	3176.8	3828	3272	226	3738	3362	56	45	3504	3502	214	56	8	42	22	145	150	+0.5	4627
HSN4000D	3616.8	4278	3722	226	4188	3812	60	45	3954	3952	214	56	10	42	22	165	150	+0.5	5298
HSN4000DM	3610	4278	3722	226	4188	3812	60	45	3954	3952	214	56	10	42	25	145	150	+0.5	5309
HSN4500D	4122.8	4778	4222	226	4688	4312	60	45	4454	4452	214	56	10	42	22	188	150	+0.5	5952
HSN4500DM	4110	4778	4222	226	4688	4312	60	45	4454	4452	214	56	10	42	25	165	150	+0.5	6011

Toothless Single-row Cross Roller Slewing Bearing

d 480~3376 mm

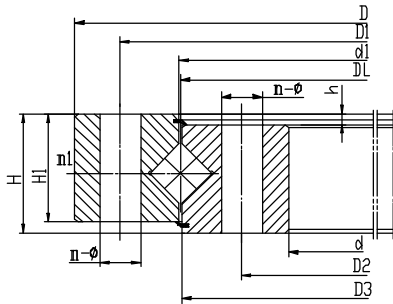

Note:

1. n1 is the amount of lubricating holes, customer can specify the position of lubricating hole according to using conditions.
2. N-phi can change to threaded hole, diameter of thread M, depth of thread 2M.
3. The product in this catalogue are standard products, please contact ZWZ if have other special requirements.

Bearing designation	Boundary Dimensions			Bolt hole dimensions				Structure dimensions						Mass kg
	D	d	H	D1	D2	n	phi	D3	d1	H1	h	n1	M	
	mm			mm				mm						
HJB430	480	380	26	462	398	20		429.4	430.6	26	0	2	8/10	12.2
HJB440.3	480	400	35		439	12	4.5	439	441.5	35	0	4	3	14.7
HJB500	602	398	75	566	434	20	18	498	502	65	10	4	16	77
HJB550/P4-NTW	600	500	40		516.5	12	4.3	548	552	40	0	4	6	26.1
HJB560	662	458	75	626	494	20	18	558	562	65	10	4	16	87
HJB630	732	528	75	696	564	24	18	628	632	65	10	4	16	95
HJB640	700	600	40	683		10		639	641	40	10	2	3	26.6
HJB675	816	573	90	753	604	18	22	673	677	73	20	4	8	142
HJB675X1	816	571	90	753	604	36	22	675	675	73	23	4	20	126
HJB675X2	816	573	90	753	604	18	22	673	677	73	20	4	20	142
HJB710	812	608	75	776	644	24	18	708	712	65	10	4	16	111
HJB780-NTW	880	680	80	846	714	4	16	778	782	80	0	4	14	149
HJB800	922	678	82	878	722	30	22	798	802	72	10	6	20	152
HJB900	1022	778	82	978	822	30	22	898	902	72	10	6	20	186
HJB1000	1122	878	82	1078	922	36	22	998	1002	72	10	6	20	204
HJB1114	1250	1000	110	1200		12		1112	1116	110	0	4	10	355
HJB1120	1242	998	82	1198	1042	36	22	1118	1122	72	10	6	20	233
HJB1135	1270	1000	100	1220	1050	36	19	1132	1138	85	15	2	16	296
HJB1250	1400	1060	120			12				120	0		24	599
HJB1400	1540	1260	91	1487	1313	40	26	1398	1402	81	10	5	24	369
HJB1520	1720	1320	134		1390	12	26	1516	1524	134	0	8	24	967
HJB1520K	1720	1320	134		1390	12	26	1516	1524	134	0	4	24	967
HJB1600	1740	1460	91	1687	1513	45	26	1598	1602	81	10	5	24	425
HJB1635	1770	1500	120					1625	1645	120	0	6		618
HJB1800	1940	1660	91	1887	1713	45	26	1798	1802	81	10	5	24	456
HJB2000	2178	1825	112	2110	1891	48	33	1997	2003	100	12	8	30	815
HJB2240	2418	2065	112	2350	2131	48	33	2237	2243	100	12	8	30	944
HJB2500	2678	2325	112	2610	2391	56	33	2497	2503	100	12	8	30	1026
HJB2745	2980	2500	180	2910	2590	48	33	2743	2747	170	10	6	30	2880
HJB2800K	2978	2625	112	2910	2691	16	33	2799	2801	100	12	4	30	1170
HJB3150	3376	2922	134	3286	3014	56	45	3147	3153	122	12	8	42	2097

Outer-tooth Cross Roller Slewing Bearing

d 629~2013.2 mm

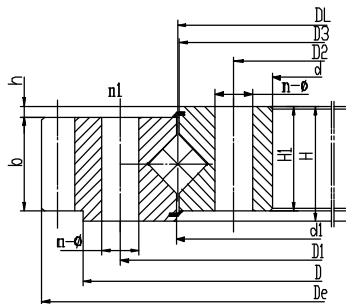

Note:

1. n1 is the amount of lubricating holes, customer can specify the position of lubricating hole according to using conditions.
2. N-φ can change to threaded hole, diameter of thread M, depth of thread 2M.
3. The product in this catalogue are standard products, please contact ZWZ if have other special requirements.

Bearing designation	Boundary Dimensions				Bolt hole dimensions				Structure dimensions						Parameters of gear				Mass kg
	De	D	d	H	D1	D2	n	φ	D3	d1	H1	h	n1	M	m	Z	b mm	x	
	mm				mm			mm	mm										
HJW500	629	602	398	75	566	434	20	18	498	502	65	10	4	16	5	123	60	+0.5	84
HJW500M	628.8	602	398	75	566	434	20	18	498	502	65	10	4	16	6	102	60	+0.5	84
HJW560	689	662	458	75	626	494	20	18	558	562	65	10	4	16	5	135	60	+0.5	92
HJW560M	688.8	662	458	75	626	494	20	18	558	562	65	10	4	16	6	112	60	+0.5	92
HJW630	772.8	732	528	75	696	564	24	18	628	632	65	10	4	16	6	126	60	+0.5	111
HJW630M	774.4	732	528	75	696	564	24	18	628	632	65	10	4	16	8	94	60	+0.5	111
HJW710	852	812	610	74	776	644	24	13.5	708	712	36.5	10	4	10	6	140	54	0	125
HJW710M	854.4	812	608	75	776	644	24	18	708	712	65	10	4	16	8	104	60	+0.5	125
HJW800	966.4	922	678	82	878	722	30	22	798	802	72	10	6	20	8	118	65	+0.5	179
HJW800M	968	922	678	82	878	722	30	22	798	802	72	10	6	20	10	94	65	+0.5	179
HJW823	979	853	715	100	893	753	28	22	821	825	84	21	4	20	10	94	63	1.1	193
HJW900	1062.4	1022	778	82	978	822	30	22	898	902	72	10	6	20	8	130	65	+0.5	189
HJW900M	1068	1022	778	82	978	822	30	22	898	902	72	10	6	20	10	104	65	+0.5	200
HJW1000	1188	1122	878	82	1078	922	36	22	998	1002	72	10	6	20	10	116	65	+0.5	242
HJW1000M	1185.6	1122	878	82	1078	922	36	22	998	1002	72	10	6	20	12	96	65	+0.5	242
HJW1025	1180	1150	885	115	1115	935	16	18	1021	1029	100	15	4	16	5	234	80	0	333
HJW1120	1272	1242	998	82	1198	1042	8	20	1118	1122	66	16	4	20	6	210	65	0	249
HJW1120M	1305.6	1242	998	82	1198	1042	36	22	1118	1122	72	10	6	20	12	106	65	+0.5	261
HJW1250	1449.6	1390	1110	91	1337	1163	40	26	1248	1252	81	10	5	24	12	118	75	+0.5	362
HJW1250M	1453.2	1390	1110	91	1337	1163	40	26	1248	1252	81	10	5	24	14	101	75	+0.5	362
HJW1262	1477	1400	1100	140	1352	1160	26	22	1260	1264	126	21	4	20	14	104	90	-0.24	607
HJW1400	1605.6	1540	1260	91	1487	1313	40	26	1398	1402	81	10	5	24	12	131	75	+0.5	417
HJW1400M	1607.2	1540	1260	91	1487	1313	40	26	1398	1402	81	10	5	24	14	112	75	+0.5	411
HJW1600	1817.2	1740	1460	91	1687	1513	45	26	1598	1602	81	10	5	24	14	127	75	+0.5	488
HJW1600M	1820.8	1740	1460	91	1687	1513	45	26	1598	1602	81	10	5	24	16	111	75	+0.5	484
HJW1800	2013.2	1940	1660	91	1887	1713	45	26	1798	1802	81	10	5	24	14	141	75	+0.5	530

Outer-tooth Cross Roller Slewing Bearing

d 2012.8~4100 mm

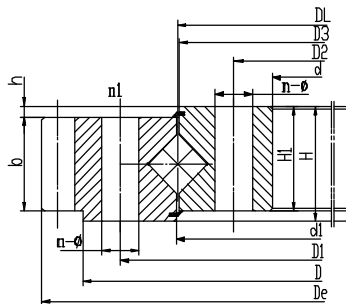

Note:

1. n1 is the amount of lubricating holes, customer can specify the position of lubricating hole according to using conditions.
2. N-φ can change to threaded hole, diameter of thread M, depth of thread 2M.
3. The product in this catalogue are standard products, please contact ZWZ if have other special requirements.

Bearing designation	Boundary Dimensions				Bolt hole dimensions				Structure dimensions						Parameters of gear				Mass kg
	De	D	d	H	D1	D2	n	φ	D3	d1	H1	h	n1	M	m	Z	b	x	
	mm				mm			mm	mm					mm					
HJW1800M	2012.8	1940	1660	91	1887	1713	45	26	1798	1802	81	10	5	24	16	123	75	+0.5	530
HJW2000	2268.8	2178	1825	112	2110	1891	48	33	1998	2002	100	12	8	30	16	139	90	+0.5	922
HJW2000M	2264.4	2178	1825	112	2110	1891	48	33	1997	2003	100	12	8	30	18	123	90	+0.5	935
HJW2240	2498.4	2418	2065	112	2350	2131	48	33	2237	2243	100	12	8	30	16	136	90	+0.5	1000
HJW2240M	2498.4	2418	2065	112	2350	2131	48	33	2237	2243	100	12	8	30	18	136	90	+0.5	1008
HJW2500	2768.4	2678	2325	112	2610	2391	56	33	2497	2503	100	12	8	30	18	151	90	+0.5	1147
HJW2500M	2776	2678	2325	112	2610	2391	56	33	2497	2502	100	12	8	30	20	136	90	+0.5	1185
HJW2800	3074.4	2978	2625	112	2910	2691	56	33	2797	2803	100	12	8	30	18	168	90	+0.5	1320
HJW2800M	3076	2978	2625	112	2910	2691	56	33	2798	2802	100	12	8	30	20	151	90	+0.5	1470
HJW3150	3476	3376	2922	134	3286	3014	56	45	3147	3153	122	12	8	42	20	171	110	+0.5	2222
HJW3150M	3471.6	3376	2922	134	3286	3014	56	45	3147	3153	122	12	8	42	22	155	110	+0.5	2222
HJW3580	4100	3970	3230	240	3820	3350	54/52	37	3578	3582	220	20	16	33	25	162	200	0	7587

Inner-tooth Cross Roller Sewing Bearing

d 367~1735.2 mm

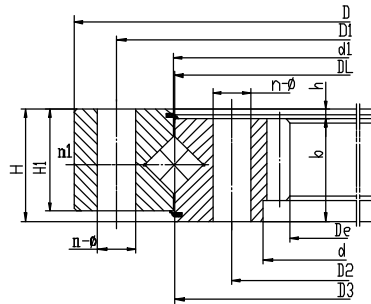

Note:

1. n1 is the amount of lubricating holes, customer can specify the position of lubricating hole according to using conditions.
2. N-φ can change to threaded hole, diameter of thread M, depth of thread 2M.
3. The product in this catalogue are standard products, please contact ZWZ if have other special requirements.

Bearing designation	Boundary Dimensions				Bolt hole dimensions				Structure dimensions						Parameters of gear				Mass kg
	De	D	d	H	D1	D2	n	φ	D3	d1	H1	h	n1	M	m	Z	b mm	x	
	mm				mm			mm	mm										
HJN500	367	602	398	75	566	434	20	18	498	502	65	10	4	16	5	74	60	+0.5	85
HJN500M	368.4	602	398	75	566	434	20	18	498	502	65	10	4	16	6	62	60	+0.5	85
HJN560	427	662	458	75	626	494	20	18	558	562	65	10	4	16	5	86	60	+0.5	96
HJN560M	428.4	662	458	75	626	494	20	18	558	562	65	10	4	16	6	72	60	+0.5	96
HJN630	494.4	732	528	75	696	564	24	18	628	632	65	10	4	16	6	83	60	+0.5	110
HJN630M	491.2	732	528	75	696	564	24	18	628	632	65	10	4	16	8	62	60	+0.5	110
HJN710	572.4	812	608	82	776	644	24	18	708	712	65	10	4	16	6	96	60	+0.5	126
HJN710M	571.2	812	608	82	776	644	24	18	708	712	65	10	4	16	8	72	60	+0.5	122
HJN800	635.2	922	678	82	878	722	30	22	798	802	72	10	6	20	8	80	65	+0.5	186
HJN800M	634	922	678	82	878	722	30	22	798	802	72	10	6	20	10	64	65	+0.5	186
HJN817	685	920	712	70	880	751	30	22	815	819	60	10	5	20	5	139	53	0	115
HJN900	739.2	1022	778	82	978	822	30	22	898	902	72	10	6	20	8	93	65	+0.5	208
HJN900M	734	1022	778	82	978	822	30	22	898	902	72	10	6	20	10	74	65	+0.5	208
HJN1000	824	1122	878	82	1078	922	36	22	998	1002	72	10	6	20	10	83	65	+0.5	220
HJN1000M	820.8	1122	878	82	1078	922	36	22	998	1002	72	10	6	20	12	69	65	+0.5	220
HJN1094S	920	1216	920	100	1172	1013	12	22	1092	1096	90	10	4	20	10	94	90	0	393
HJN1120	944	1242	998	82	1198	1042	36	22	1118	1122	72	10	6	20	10	95	65	+0.5	273
HJN1120M	940.8	1242	998	82	1198	1042	36	22	1118	1122	72	10	6	20	12	79	65	+0.5	273
HJN1250	1048.8	1390	1110	91	1337	1163	40	26	1248	1252	81	10	5	24	12	88	75	+0.5	386
HJN1250M	1041.6	1390	1110	91	1337	1163	40	26	1248	1252	81	10	5	24	14	75	75	+0.5	390
HJN1400	1192.8	1540	1260	91	1487	1313	40	26	1398	1402	81	10	5	24	12	100	75	+0.5	441
HJN1400M	1195.6	1540	1260	91	1487	1313	40	26	1398	1402	81	10	5	24	14	86	75	+0.5	441
HJN1600	1391.6	1740	1460	91	1687	1513	45	26	1598	1602	81	10	5	24	14	100	75	+0.5	502
HJN1600M	1382.4	1740	1460	91	1687	1513	45	26	1598	1602	81	10	5	24	16	87	75	+0.5	517
HJN1800	1573.6	1940	1660	91	1887	1713	45	26	1798	1802	81	10	5	24	14	113	75	+0.5	605
HJN1800M	1574.4	1940	1660	91	1887	1713	45	26	1798	1802	81	10	5	24	16	99	75	+0.5	605
HJN2000	1734.4	2178	1825	112	2110	1891	48	33	1998	2002	100	12	8	30	16	109	90	+0.5	893
HJN2000M	1735.2	2178	1825	112	2110	1891	48	33	1997	2003	100	12	8	30	18	97	90	+0.5	977

Inner-tooth Cross Roller Sewing Bearing

d 1990.4 ~ 2824.8 mm

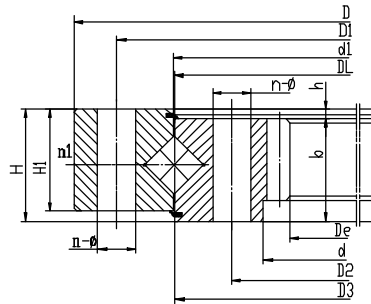

Note:

1. n1 is the amount of lubricating holes, customer can specify the position of lubricating hole according to using conditions.
2. N-φ can change to threaded hole, diameter of thread M, depth of thread 2M.
3. The product in this catalogue are standard products, please contact ZWZ if have other special requirements.

Bearing designation	Boundary Dimensions				Bolt hole dimensions				Structure dimensions						Parameters of gear				Mass kg
	De	D	d	H	D1	D2	n	φ	D3	d1	H1	h	n1	M	m	Z	b mm	x	
	mm				mm			mm	mm					mm					
HJN2240	1990.4	2418	2065	112	2350	2131	48	33	2237	2243	100	12	8	30	16	125	90	+0.5	1000
HJN2240M	1987.2	2418	2065	112	2350	2131	48	33	2237	2243	100	12	8	30	18	111	90	+0.5	1072
HJN2460	2154.5	2670	2240	160	2600	2320	54	35	2457	2463	140	20	6	33	16	136	120	0.3	1852
HJN2500	2239.2	2678	2325	112	2610	2391	56	33	2497	2503	100	12	8	30	18	125	90	+0.5	1211
HJN2500M	2228	2678	2325	112	2610	2391	56	33	2497	2503	100	12	8	30	20	112	90	+0.5	1211
HJN2800	2527.2	2978	2625	112	2910	2691	56	33	2797	2803	100	12	8	30	18	141	90	+0.5	1396
HJN2800M	2528	2978	2625	112	2910	2691	56	33	2797	2803	100	12	8	30	20	127	90	+0.5	1396
HJN3150	2828	3376	2922	134	3286	3014	56	45	3147	3153	122	12	8	42	20	142	110	+0.5	2344
HJN3150M	2824.8	3376	2922	134	3286	3014	56	45	3147	3153	122	12	8	42	22	129	110	+0.5	2344

Toothless Three-row Cylindrical Roller Slewing Bearing

d 634 ~ 5335 mm

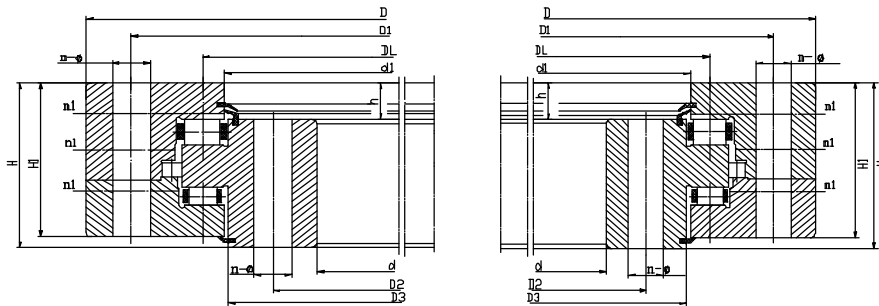

Note:

1. n1 is the amount of lubricating holes, customer can specify the position of lubricating hole according to using conditions.
2. N-φ can change to threaded hole, diameter of thread M, depth of thread 2M.
3. The product in this catalogue are standard products, please contact ZWZ if have other special requirements.

Bearing designation	Boundary Dimensions			Bolt hole dimensions				Structure dimensions						Mass
	D	d	H	D1	D2	n	φ	D3	d1	H1	h	n1	M	
	mm			mm				mm						kg
HYB500	634	366	148	598	402	24	18	474	463	138	32	4	16	191
HYB560	694	426	148	658	462	24	18	534	523	138	32	4	16	214
HYB630	764	496	148	728	532	28	18	604	593	138	32	4	16	240
HYB710	844	576	148	808	612	28	18	684	673	138	32	4	16	272
HYB800	964	636	182	920	680	36	22	770	759	172	40	4	20	459
HYB900	1064	736	182	1020	780	36	22	870	859	172	40	4	20	519
HYB1000	1164	836	182	1120	880	40	22	970	959	172	40	5	20	577
HYB1120	1284	956	182	1240	1000	40	22	1090	1079	172	40	5	20	650
HYB1150	1310	1000	140	1250	1055	36	26	1120	1310	130	0	4	24	531
HYB1250	1445	1055	220	1393	1107	45	26	1210	1200	210	50	5	24	1030
HYB1400	1595	1205	220	1543	1257	45	26	1363	1350	210	50	5	24	1170
HYB1600	1795	1405	220	1743	1457	48	26	1563	1550	210	50	6	24	1341
HYB1705	1910	1500	182	1844	1566	48	33	1749	1755	162	10	24	30	1226
HYB1800	1995	1605	220	1943	1657	48	26	1763	1750	210	50	6	24	1510
HYB1825	2020	1655	136	1950	1725	36/40	33	1880	1865	123	13	5	30	870
HYB1835	2020	1655	156	1950	1725	36/40	33	1882	1877	123	19	6	30	955
HYB2000	2221	1779	231	2155	1845	60	33	1967	1945	219	54	6	30	1949
HYB2240	2461	2019	231	3395	2085	60	33	2207	2185	219	54	6	30	2197
HYB2400	2650	2190	154	2560	2280	60	39	2446	2442	121	14	6	36	1580
HYB2500	2721	2279	231	2655	2345	72	33	2553	2533	219	12	8	30	2391
HYB2500C	2721	2279	231	2655	2345	72	33	2555	2533	177	12	8	30	2391
HYB2800	3021	2579	231	2955	2645	72	33	2867	2833	219	54	8	30	2924
HYB3150	3432	2868	270	3342	2958	72	45	3104	3090	258	65	8	42	4551
HYB3175	3395	2965	184	3328	3038	64	33	3221	3206	154	10.5	8	30	2523
HYB3550	3832	3268	270	3742	3358	72	45	3504	3490	258	65	8	42	5178
HYB4000	4243	3762	270	4165	3840	72	39	4050	4037	217	55	9	36	4580
HYB4500	4850	4235	268	4700	4325	68	45	4560	4546	203	10	11	42	7150
HYB5000	5290	4735	268	5200	4825	78	39	5064	5048	203	10	12	36	7280
HYB5055	5335	4785	275	5245	4875	90	45	5101	5130	210	17	15	42	7376

Inner-tooth Three-row Cylindrical Roller Slewing Bearing

d 337~1702.4 mm

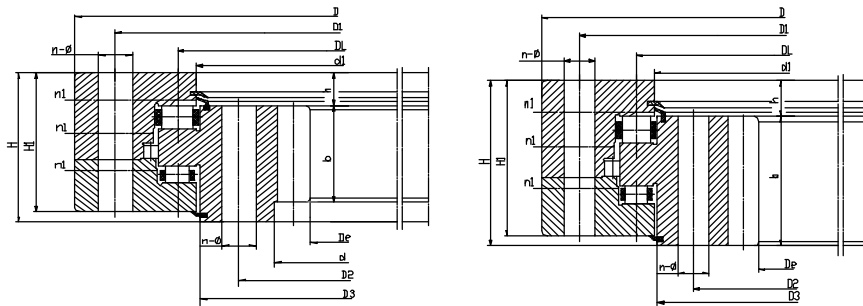

Note:

1. n1 is the amount of lubricating holes, customer can specify the position of lubricating hole according to using conditions.
2. N-φ can change to threaded hole, diameter of thread M, depth of thread 2M.
3. The product in this catalogue are standard products, please contact ZWZ if have other special requirements.

Bearing designation	Boundary Dimensions				Bolt hole dimensions				Structure dimensions						Parameters of gear				Mass kg
	De	D	d	H	D1	D2	n	φ	D3	d1	H1	h	n1	M	m	Z	b	x	
	mm				mm														
HYN500	337	634	366	148	598	402	24	18	474	463	138	32	4	16	5	68	80	+0.5	198
HYN500M	338.4	634	366	148	598	402	24	18	474	463	138	32	4	16	6	57	80	+0.5	198
HYN560	397	694	426	148	658	462	24	18	534	523	138	32	4	16	5	80	80	+0.5	222
HYN560M	398.4	694	426	148	658	462	24	18	534	523	138	32	4	16	6	67	80	+0.5	220
HYN630	458.4	764	496	148	728	532	28	18	604	593	138	32	4	16	6	77	80	+0.5	253
HYN630M	459.2	764	496	148	728	532	28	18	604	593	138	32	4	16	8	58	80	+0.5	251
HYN710	536.4	844	567	148	808	612	28	18	684	673	138	32	4	16	6	90	80	+0.5	288
HYN710M	539.2	844	567	148	808	612	28	18	684	673	138	32	4	16	8	68	80	+0.5	284
HYN800	595.2	964	636	182	920	680	36	22	770	759	172	40	4	20	8	75	120	+0.5	483
HYN800M	594	964	636	182	920	680	36	22	770	759	172	40	4	20	10	60	120	+0.5	481
HYN900	691.2	1064	736	182	1020	780	36	22	870	859	172	40	4	20	8	87	120	+0.5	551
HYN900M	694	1064	736	182	1020	780	36	22	870	859	172	40	4	20	10	70	120	+0.5	545
HYN1000	784	1164	836	182	1120	880	40	22	970	959	172	40	5	20	10	79	120	+0.5	618
HYN1000M	784.8	1164	836	182	1120	880	40	22	970	959	172	40	5	20	12	66	120	+0.5	613
HYN1120	904	1284	956	182	1240	100	40	22	1090	1079	172	40	5	20	10	91	120	+0.5	698
HYN1120M	904.8	1284	956	182	1240	1000	40	22	1090	1079	172	40	5	20	12	76	120	+0.5	691
HYN1250	988.8	1445	1055	220	1393	1107	45	26	1213	1200	210	50	5	24	12	83	150	+0.5	1123
HYN1250M	985.6	1445	1055	220	1393	1107	45	26	1213	1200	210	50	5	24	14	71	150	+0.5	1122
HYN1400	1144.8	1595	1205	220	1543	1257	45	26	1363	1350	210	50	5	24	12	96	150	+0.5	1254
HYN1400M	1139.6	1595	1205	220	1543	1257	45	26	1363	1350	210	50	5	24	14	82	150	+0.5	1258
HYN1600	1335.6	1795	1405	220	1743	1457	48	26	1563	1500	210	50	6	24	14	96	150	+0.5	1454
HYN1600M	1334.4	1795	1405	220	1743	1457	48	26	1563	1500	210	50	6	24	16	84	150	+0.5	1448
HYN1800	1531.6	1995	1605	220	1943	1657	48	26	1763	1750	210	50	6	24	14	110	150	+0.5	1658
HYN1800M	1526.4	1995	1605	220	1943	1657	48	26	1763	1750	210	50	6	24	16	96	150	+0.5	1663
HYN1992	1740	2180		153	2115	1870	66	33	1966	1948	141	33	8	30	12	146	120	0.5	1280
HYN2000	1760	2147		132	2095	1895	54	26	1968	1969	123	26	5	24	16	111	106	+0.5	902
HYN2000R	1728	2181		147	2115	1875	44	33	1974	1963	138	30	7	30	16	109	117	+0.5	1202
HYN2000R1	1702.4	2221	1779	231	2155	1845	60	33	1967	1945	219	54	6	30	16	107	160	+0.5	2114

Inner-tooth Three-row Cylindrical Roller Slewing Bearing

d 1699.2 ~ 4110 mm

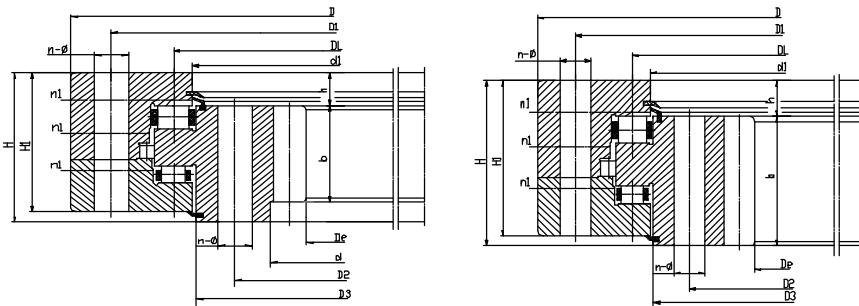

Note:

1. n1 is the amount of lubricating holes, customer can specify the position of lubricating hole according to using conditions.
2. N-φ can change to threaded hole, diameter of thread M, depth of thread 2M.
3. The product in this catalogue are standard products, please contact ZWZ if have other special requirements.

Bearing designation	Boundary Dimensions				Bolt hole dimensions				Structure dimensions						Parameters of gear				Mass kg
	De	D	d	H	D1	D2	n	φ	D3	d1	H1	h	n1	M	m	Z	b	x	
	mm				mm				mm										
HYN2000R1M	1699.2	2221	1779	231	2155	1845	60	33	1967	1945	219	54	6	30	18	95	160	+0.5	2112
HYN2138	1820	2320	1910	160	2255	1990	30/40	37.5	2144	2105	140	20	4	36	14	132	110	0	1500
HYN2230	1862	2540	1945	265	2436	2020	72/68	45	2166	2150	253	60	9	42	16	117	165	+0.5	3530
HYN2240	1944	2421		147	2355	2115	48	33	2214	2203	138	30	8	30	18	109	117	+0.5	1406
HYN2240R	1908	2458		181	2380	2085	40	39	2210	2199	172	42	8	36	18	107	139	+0.5	2010
HYN2240R1	1924.4	2461	2019	231	2395	2085	60	33	2207	2185	219	54	6	30	16	121	160	+0.5	2447
HYN2240R1M	1933.2	2461	2019	231	2395	2085	60	33	2207	2185	219	54	6	30	18	108	160	+0.5	2407
HYN2500	2185.2	2721		241	2655	2341	24/72	39	2460	2443	229	54	4	36	18	122	170	+0.5	2817
HYN2500R	2178	2718		181	2640	2345	44	39	2470	2459	172	42	7	36	18	122	139	+0.5	2210
HYN2500R1	2185.2	2721	2279	231	2655	2345	72	33	2467	2445	219	54	8	30	18	122	160	+0.5	2862
HYN2500R1M	2188	2721	2279	231	2655	2345	72	33	2467	2445	219	54	8	30	20	110	160	+0.5	2834
HYN2800	2500	2981		147	2915	2675	60	33	2774	2763	138	30	10	30	20	126	117	+0.5	1767
HYN2800R	2460	3018		181	2940	2645	48	39	2770	2759	172	42	8	36	20	124	139	+0.5	2542
HYN2800R1	2460	3038		220	2960	2635	48	39	2763	2750	210	50	8	36	20	124	170	+0.5	3213
HYN2800R2	2491.2	3021	2579	231	2955	2645	72	33	2767	2745	219	54	8	30	18	139	160	+0.5	3211
HYN2800R2M	2488	3021	2579	231	2955	2645	72	33	2767	2745	219	54	8	30	20	125	160	+0.5	3209
HYN3150	2820	3368		181	3290	2995	56	39	3120	3109	172	42	7	36	20	142	139	+0.5	2807
HYN3150R	2794	3368		220	3310	2985	56	39	3113	3100	210	50	7	36	22	128	170	+0.5	3683
HYN3150R1	2768	3432	2868	270	3342	2958	72	45	3104	3090	258	65	8	42	20	139	180	+0.5	4954
HYN3150R1M	2758.8	3432	2868	270	3342	2958	72	45	3104	3090	258	65	8	42	22	126	180	+0.5	4988
HYN3474	3140	3240	3240	173	3600	3310	100	33	3447	3434	152	30	10	30	20	158	140	+0.5	2640
HYN3550	3190	3768		181	3690	3395	66	39	3520	3509	172	42	8	36	22	146	139	+0.5	3302
HYN3550R	3190	3788		220	3710	3385	66	39	3513	3500	210	50	8	36	22	146	170	+0.5	4171
HYN3550R1	3168	3832	3268	270	3742	3358	72	45	3504	3490	258	65	8	42	20	159	180	+0.5	5638
HYN3550R1M	3154.8	3832	3268	270	3742	3358	72	45	3504	3490	258	65	8	42	22	144	180	+0.5	5706
HYN4000	3652	4218		181	4140	3845	72	39	3970	3959	172	42	9	36	22	167	139	+0.5	3664
HYN4000R	3624	4238		220	4160	3835	72	39	3963	3950	210	50	9	36	24	152	170	+0.5	4810
HYN4000R1	3616.8	4282	3718	270	4192	3808	80	45	3954	3940	258	65	8	42	22	165	180	+0.5	6257
HYN4000R1M	3610	4282	3718	270	4192	3808	80	45	3954	3940	258	65	8	42	25	145	180	+0.5	6268
HYN4500	4092	4765		281	4675	4300	72	45	4454	4440	258	65	12	42	22	187	170	+0.5	7740
HYN4500R	4122.8	4782	4218	270	4692	4308	80	45	4454	4440	258	65	8	42	22	188	180	+0.5	7040
HYN4500RM	4110	4782	4218	270	4692	4308	80	45	4454	4440	258	65	8	42	25	165	180	+0.5	7108

Outer-tooth Three-row Cylindrical Roller Slewing Bearing

d 664 ~ 2300.8 mm

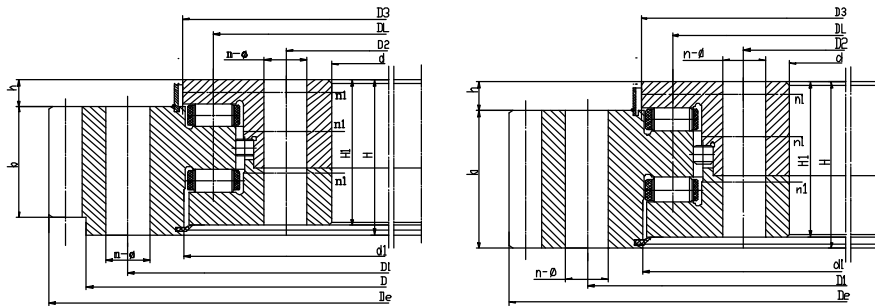

Note:

1. n1 is the amount of lubricating holes, customer can specify the position of lubricating hole according to using conditions.
2. N-φ can change to threaded hole, diameter of thread M, depth of thread 2M.
3. The product in this catalogue are standard products, please contact ZWZ if have other special requirements.

Bearing designation	Boundary Dimensions				Bolt hole dimensions				Structure dimensions						Parameters of gear				Mass kg
	De	D	d	H	D1	D2	n	φ	D3	d1	H1	h	n1	M mm	m	Z	b mm	x	
	mm				mm				mm										
HYW500	664	634	366	148	598	402	24	18	537	526	138	32	4	16	5	130	80	+0.5	200
HYW500M	664.8	634	366	148	598	402	24	18	537	526	138	32	4	16	6	108	80	+0.5	200
HYW560	724	694	426	148	658	462	24	18	597	586	138	32	4	16	5	142	80	+0.5	224
HYW560M	724.8	694	426	148	658	462	24	18	597	586	138	32	4	16	6	118	80	+0.5	224
HYW630	808.8	764	496	148	728	532	28	18	667	656	138	32	4	16	6	132	80	+0.5	262
HYW630M	806.4	764	496	148	728	532	28	18	667	656	138	32	4	16	8	98	80	+0.5	257
HYW710	886.8	844	567	148	808	612	28	18	747	736	138	32	4	16	6	145	80	+0.5	295
HYW710M	886.4	844	567	148	808	612	28	18	747	736	138	32	4	16	8	108	80	+0.5	291
HYW800	1006.4	964	636	182	920	680	36	22	841	830	172	40	4	20	8	123	120	+0.5	490
HYW800M	1008	964	636	182	920	680	36	22	841	830	172	40	4	20	10	98	120	+0.5	487
HYW900	1102.4	1064	736	182	1020	780	36	22	941	930	172	40	4	20	8	135	120	+0.5	549
HYW900M	1108	1064	736	182	1020	780	36	22	941	930	172	40	4	20	10	108	120	+0.5	562
HYW1000	1218	1164	836	182	1120	880	40	22	1041	1030	172	40	5	20	10	119	120	+0.5	631
HYW1000M	1221.6	1164	836	182	1120	880	40	22	1041	1030	172	40	5	20	12	99	120	+0.5	631
HYW1120	1338	1284	956	182	1240	100	40	22	1161	1150	172	40	5	20	10	131	120	+0.5	710
HYW1120M	1341.6	1284	956	182	1240	1000	40	22	1161	1150	172	40	5	20	12	109	120	+0.5	710
HYW1250	1509.6	1445	1055	220	1393	1107	45	26	1300	1287	210	50	5	24	12	123	150	+0.5	1137
HYW1250M	1509.2	1445	1055	220	1393	1107	45	26	1300	1287	210	50	5	24	14	105	150	+0.5	1126
HSW1358	1510	1470	1215	90	1426	1255	24	22	1362	1354	71	19	6	20	10	149	71	0	256
HYW1400	1665.6	1595	1205	220	1543	1257	45	26	1450	1437	210	50	5	24	12	136	150	+0.5	1299
HYW1400M	1663.2	1595	1205	220	1543	1257	45	26	1450	1437	210	50	5	24	14	116	150	+0.5	1281
HYW1600	1873.2	1795	1405	220	1743	1457	48	26	1650	1637	210	50	6	24	14	131	150	+0.5	1501
HYW1600M	1868.8	1795	1405	220	1743	1457	48	26	1650	1637	210	50	6	24	16	114	150	+0.5	1471
HYW1800	2069.2	1995	1605	220	1943	1657	48	26	1850	1837	210	50	6	24	14	145	150	+0.5	1682
HYW1800M	2076.8	1995	1605	220	1943	1657	48	26	1850	1837	210	50	6	24	16	127	150	+0.5	1697
HYW1898	2169.6	2113	1690	181	2049	1762	54	36	1941	1930	172	32	6	34	12	178	100	+0.5	1470
HYW2000	2236.8		1853	132	2105	1905	54	26	2030	2032	123	26	5	24	16	137	106	+0.5	912
HYW2000R	2268.8		1819	147	2125	1885	44	33	2036	2026	138	30	7	30	16	139	117	+0.5	1216
HYW2000R1	2300.8	2221	1779	231	2155	1845	60	33	2055	2033	219	54	6	30	16	141	160	+0.5	2147

Outer-tooth Three-row Cylindrical Roller Slewing Bearing

d 2300.4 ~ 3936 mm

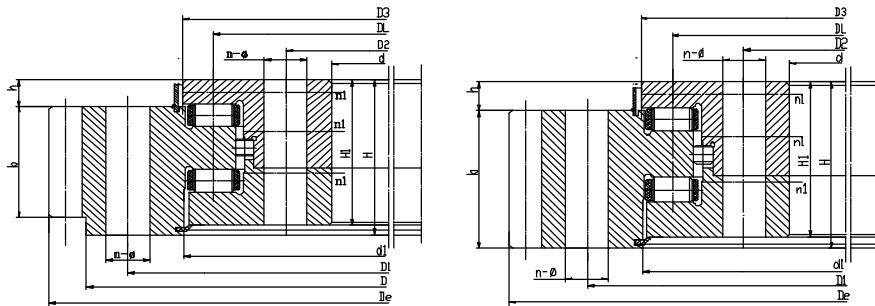

Note:

1. n1 is the amount of lubricating holes, customer can specify the position of lubricating hole according to using conditions.
2. N-φ can change to threaded hole, diameter of thread M, depth of thread 2M.
3. The product in this catalogue are standard products, please contact ZWZ if have other special requirements.

Bearing designation	Boundary Dimensions				Bolt hole dimensions				Structure dimensions						Parameters of gear				Mass kg
	De	D	d	H	D1	D2	n	φ	D3	d1	H1	h	n1	M	m	Z	b	x	
	mm				mm				mm										
HYW2000R1M	2300.4	2221	1779	231	2366	1845	60	33	2055	2033	219	54	6	30	18	125	160	+0.5	2129
HYW2240	2556.8	2461	2019	231	2395	2085	60	33	2298	2276	219	54	9	30	16	157	160	+0.5	2478
HYW2240R	2552.4		2022	181	2395	2100	40	39	2281	2270	172	42	8	36	18	139	139	+0.5	1975
HYW2240R1	2556.8	2461	2019	231	2395	2085	60	33	2295	2273	219	54	6	30	16	157	160	+0.5	2501
HYW2240R1M	2552.4	2461	2019	231	2625	2085	60	33	2295	2273	219	54	6	30	18	139	160	+0.5	2461
HYW2250	2481.6	2425	2071	155	2376	2137	72	33	2287	2276	146	28	6	30	12	204	127	+0.5	1240
HYW2250X1	2534	2492	2050	159	2394	2128	70	39	2291	2279	149	33	7	36	14	178	100	+0.5	1500
HYW2500	2822.4	2721	2279	231	2655	2345	72	33	2555	2533	219	54	8	30	18	154	177	+0.5	2410
HYW2500R	2822.4		2282	181	2655	2360	44	39	2541	2530	172	42	7	36	18	154	139	+0.5	2260
HYW2500R1	2822.4	2721	2279	231	2655	2345	72	33	2555	2533	219	54	8	30	18	154	160	+0.5	2786
HYW2500M	2816	2721	2279	231	2925	2345	72	33	2555	2533	219	54	8	30	20	138	160	+0.5	2731
HYW2555	2996	2905	2236	315	2802	2348	64	56	2643	2606	305	50	8	52	20	147	200	+0.5	5515
HYW2555X1	2998.7	2905	2236	270	2802	2348	80	45	2639	2596	260	50	8	42	20	147	180	+0.5	4758
HYW2800	3110.4	3021	2579	231	2955	2645	72	33	2855	2833	219	54	8	30	18	170	160	+0.5	2914
HYW2800R	3136		2582	181	2965	2660	48	39	2841	2830	172	42	8	36	20	154	139	+0.5	2576
HYW2800R1	3136		2562	220	2965	2640	48	39	2850	2837	210	50	8	36	20	154	170	+0.5	3267
HYW2800R2	3110.4	3021	2579	231	2955	2645	72	33	2855	2833	219	54	8	30	18	170	160	+0.5	3067
HYW2800M	3116	3021	2579	231	2955	2645	72	33	2855	2833	219	54	8	30	20	153	160	+0.5	3079
HYW2800X1	3148.8	3065	2546	223	2975	2636	60	45	2860	2839	210	53	10	42	16	194	140	+0.5	3400
HYW2825	3168		2575	240	3005	2655	48	36	2875	2865	210	50	8	30	18	174	190	0	3657
HYW2960	3375.2	3285	2632	320	3189	2738	72	56	3044	3012	311	65	9	54	20	166	200	+0.5	6280
HYW3150	3476		2932	181	3305	3010	56	39	3191	3180	172	42	7	36	20	171	139	+0.5	2828
HYW3150R	3515.6		2912	220	3315	2990	56	39	3200	3187	210	50	7	36	22	157	170	+0.5	3812
HYW3150R1	3536	3432	2868	270	3342	2958	72	45	3213	3916	258	65	8	42	20	174	180	+0.5	5025
HYW3150M	3537.6	3432	2868	270	3342	2958	72	45	3213	3916	258	65	8	42	22	158	180	+0.5	5009
HYW3550	3970	3820	3268	270	3742	3358	72	45	3613	3596	258	65	8	42	25	156	200	+0.5	5894
HYW3550R	3911.6		3312	220	3715	3390	66	39	3600	3587	210	50	8	36	22	175	170	+0.5	4255
HYW3550R1	3936	3832	3268	270	3742	3358	72	45	3613	3596	258	65	8	42	20	194	180	+0.5	5713

Outer-tooth Three-row Cylindrical Roller Slewing Bearing

d 3911.6 ~ 5491.2 mm

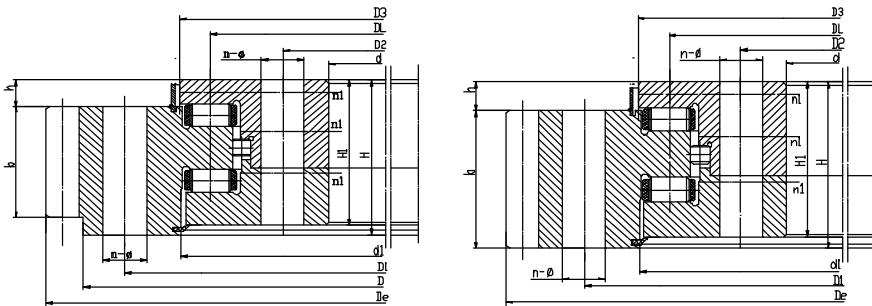

Note:

1. n1 is the amount of lubricating holes, customer can specify the position of lubricating hole according to using conditions.
2. N-φ can change to threaded hole, diameter of thread M, depth of thread 2M.
3. The product in this catalogue are standard products, please contact ZWZ if have other special requirements.

Bearing designation	Boundary Dimensions				Bolt hole dimensions				Structure dimensions						Parameters of gear				Mass kg
	De	D	d	H	D1	D2	n	φ	D3	d1	H1	h	n1	M	m	Z	b	x	
	mm				mm				mm										
HYW3550M	3911.6	3811	3312	220	3715	3390	66	39	3600	3587	210	50	8	36	22	176	180	+0.5	5661
HYW3580	3931.2		3340	212	3735	3441	108	33	3642	3608	180	42	10	30	24	161	170	+0.5	3850
HYW3580K	3931.2		3340	212	3735	3441	120/108	33	3642	3608	180	42	10	30	24	161	170	+0.5	3840
HYW3580X1	3931.2		3340	211	3735	3441	108	39	3642	3608	180	41	10	30	24	161	170	+0.5	3860
HYW3586	3931.2		3340	222	3735	3441	144/120	33	3650	3619	210	52	10	30	24	161	170	+0.5	4686
HYW3590	3902.6		3370	192	3754	3448	96	39	3655	3619	180	44	12	36	16	240	148	+1.0	3460
HYW3698	4076	3982	3415	270	3892	3508	80	45	3766	3746	258	65	8	42	20	201	180	+0.5	5770
HYW3905	4266	4173	3650	222	4085	3740	90	45	3974	3943	210	50	8	42	20	210	172	+0.75	5475
HYW3905X1	4266	4173	3650	222	4085	3740	90	45	3974	3943	210	50	8	42	20	210	172	+0.7496	4780
HYW3925	4370		3663	280	4148	3748	80	45	3995	3972	270	58	10	42	25	172	220	+0.5	7150
HYW4000	4395.6	4282	3718	270	4192	3808	80	45	4062	4046	258	65	8	42	22	197	180	+0.5	6396
HYW4000R	4363.2		3762	220	4165	3840	72	39	4050	4037	210	50	9	36	24	179	170	+0.5	4805
HYW4000R1	4395.6	4282	3718	270	4192	3808	80	45	4063	4046	258	65	8	42	22	197	180	+0.5	6508
HYW4000M	4400	4282	3718	270	4192	3808	80	45	4062	4046	258	65	8	42	25	173	180	+0.5	6486
HYW4150	4527.6	4423	3870	240	4340	3960	80	45	4224	4175	230	55	8	42	22	203	180	+0.5	5910
HYW4170	4579.2		3905	265	4345	4000	144/120	39	4245	4236	252	75	8	36	24	188	190	+0.5	6292
HYW4500	4867.2		4262	220	4665	4340	84	39	4550	4537	210	50	14	36	24	200	170	+0.5	5410
HYW4500R	4880	4782	4218	270	4692	4308	80	45	4565	4553	258	60	16	42	20	242	185	+0.5	7240
HYW4500RX1	4901.6	4782	4218	270	4692	4308	80	45	4563	4553	258	60	16	42	22	220	180	+0.5	7440
HYW4500M	4895	4782	4218	270	4692	4308	80	45	4565	4553	258	65	16	42	25	193	185	+0.5	7239
HYW4630	5160	5060	4375	275	4820	4455	88	45	4710	4678	258	70	11	42	20	256	177	0	8640
HYW5137	5491.2		4914	261	5295	4980	72	33	5237.6	5178	210	50	12	30	24	226	211	+0.4	6430

Appendix A Slewing Bearing Load Curve

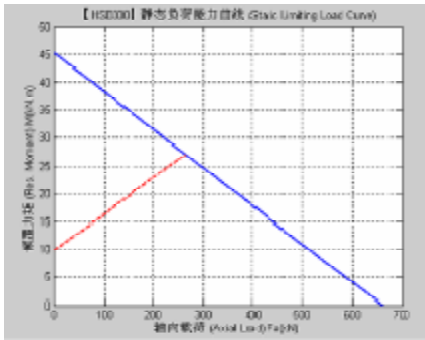

Figure A-1

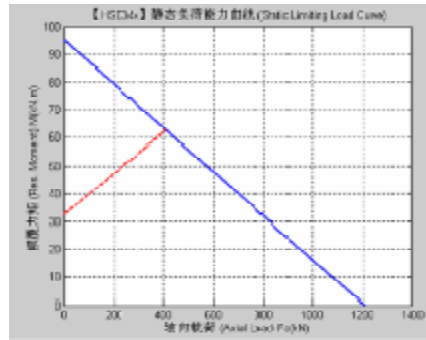

Figure A-2

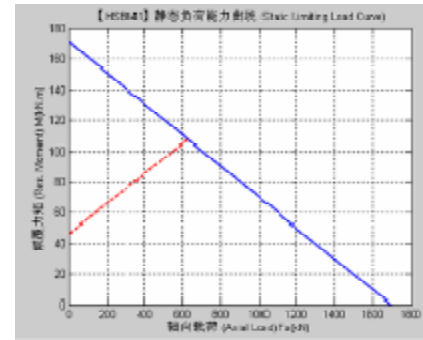

Figure A-7

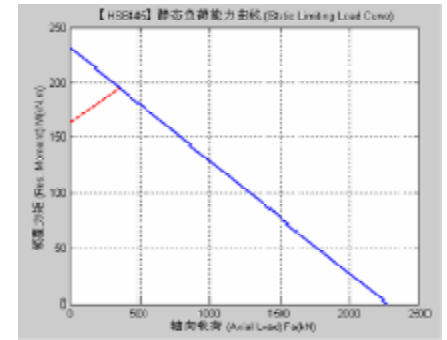

Figure A-8

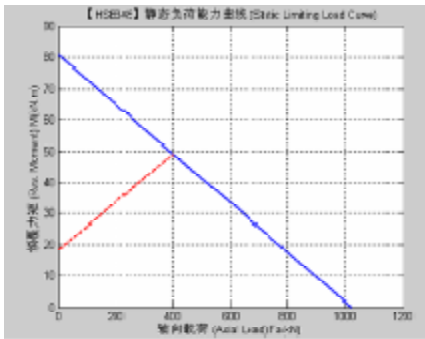

Figure A-3

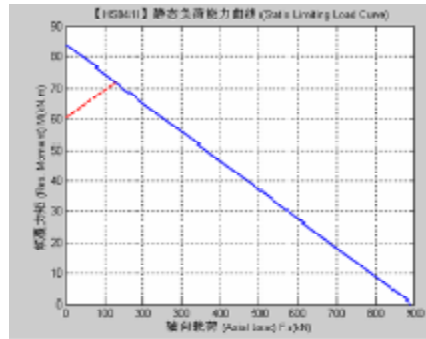

Figure A-4

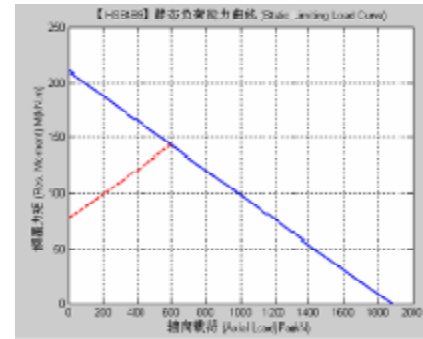

Figure A-9

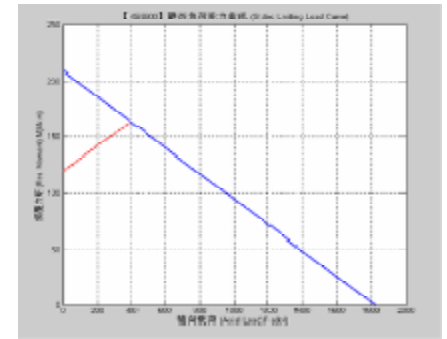

Figure A-10

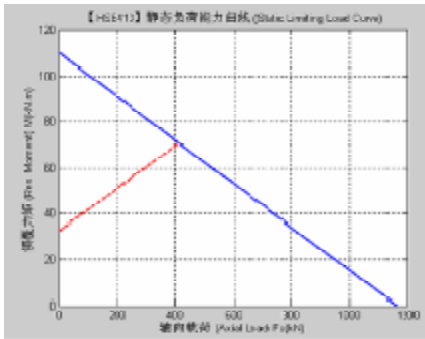

Figure A-5

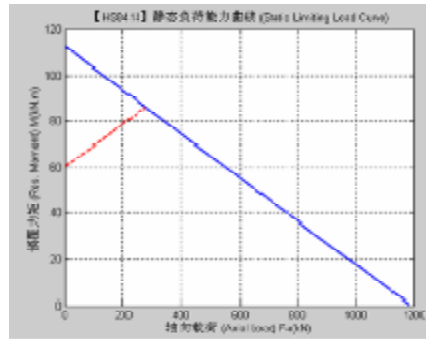

Figure A-6

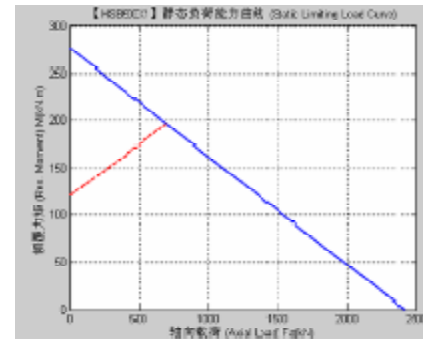

Figure A-11

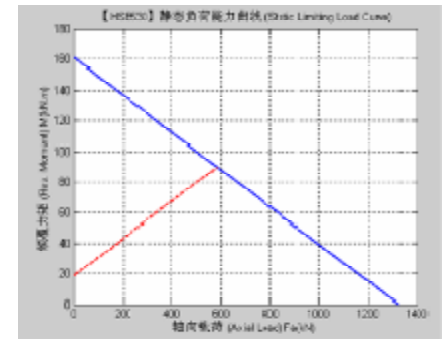

Figure A-12

Appendix A Slewing Bearing Load Curve

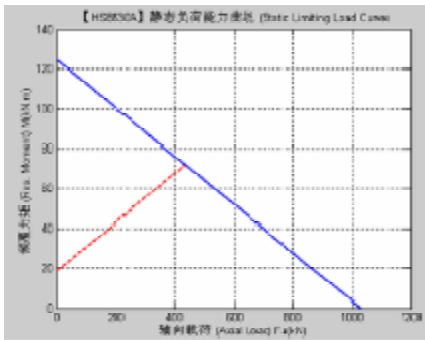

Figure A-13

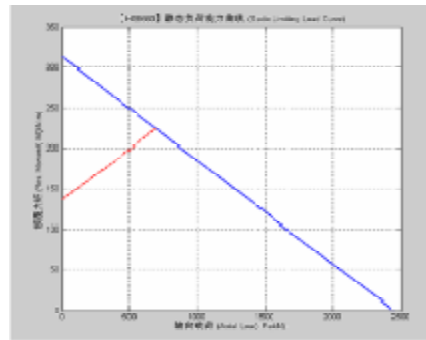

Figure A-14

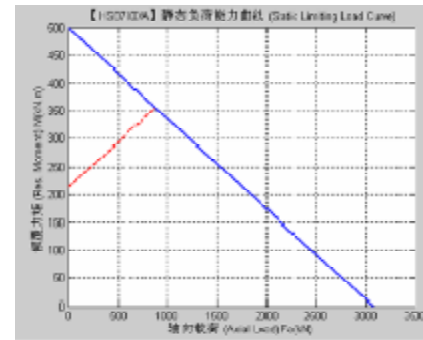

Figure A-19

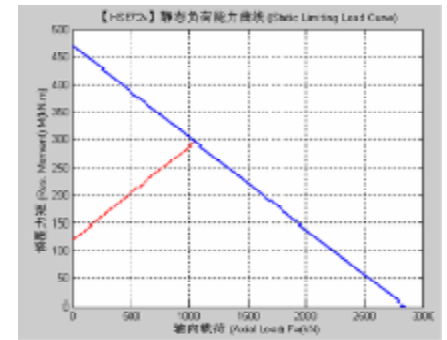

Figure A-20

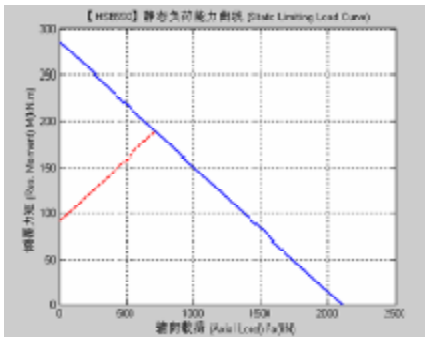

Figure A-15

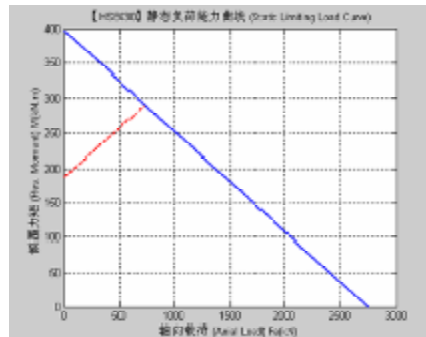

Figure A-16

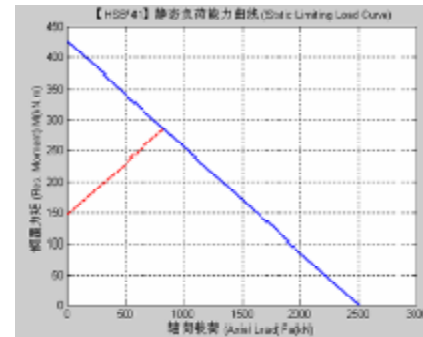

Figure A-21

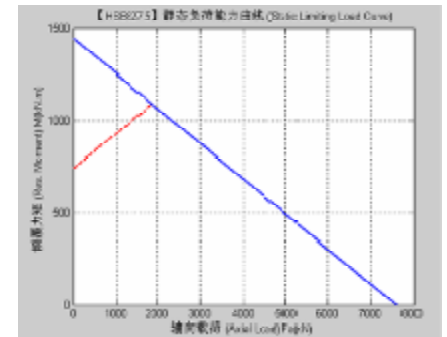

Figure A-22

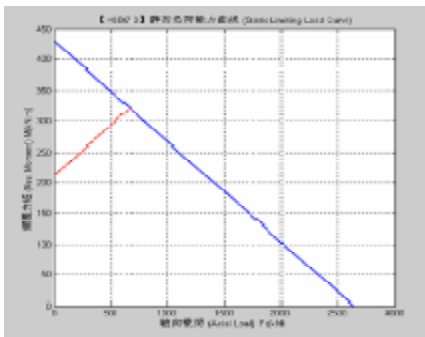

Figure A-17

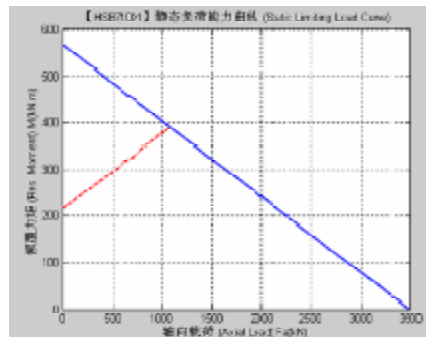

Figure A-18

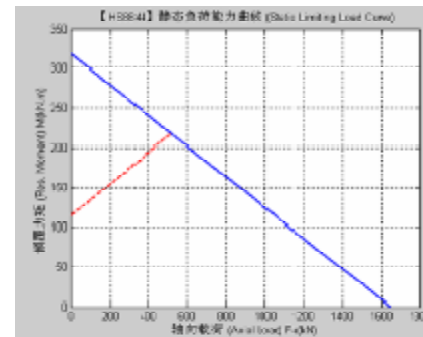

Figure A-23

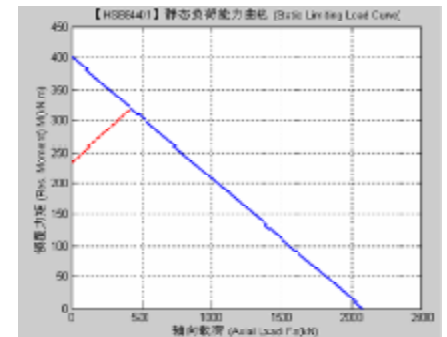

Figure A-24

Appendix A Slewing Bearing Load Curve

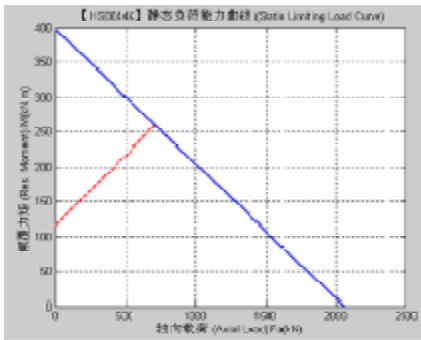

Figure A-25

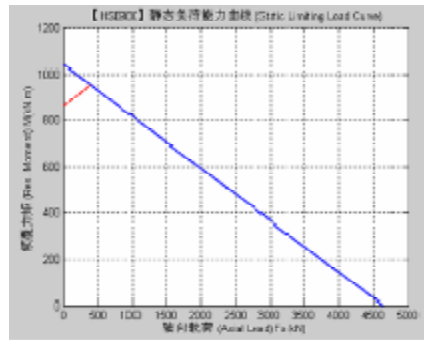

Figure A-26

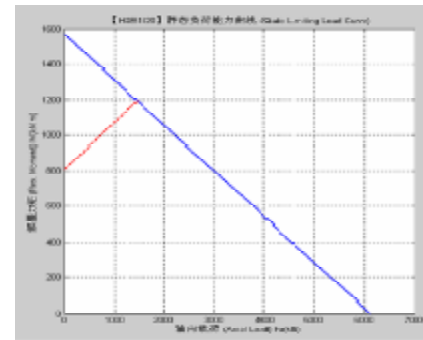

Figure A-31

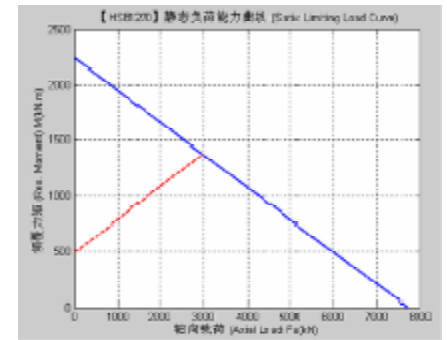

Figure A-32

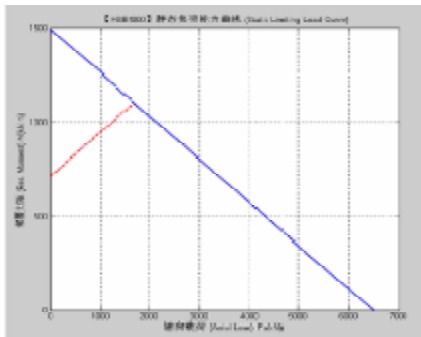

Figure A-27

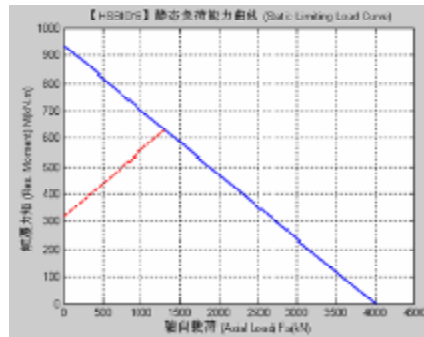

Figure A-28

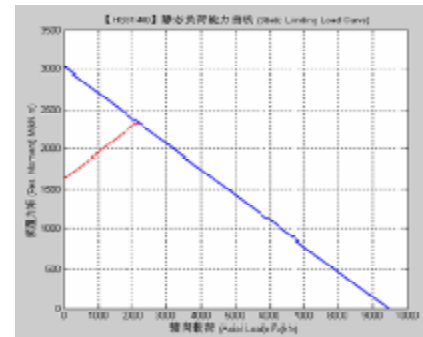

Figure A-33

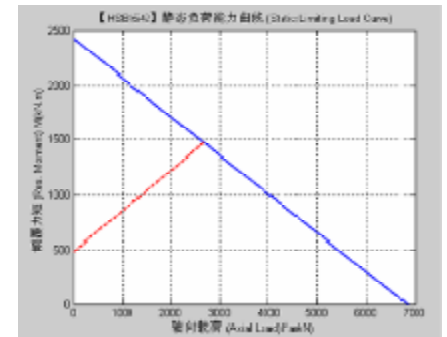

Figure A-34

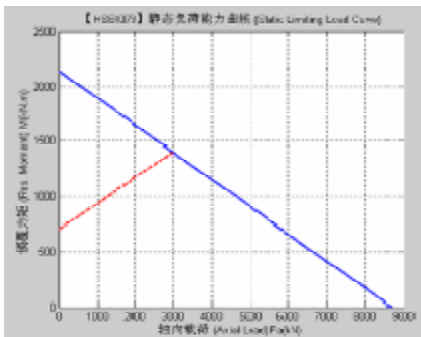

Figure A-29

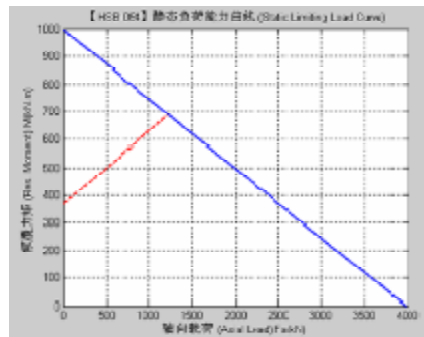

Figure A-30

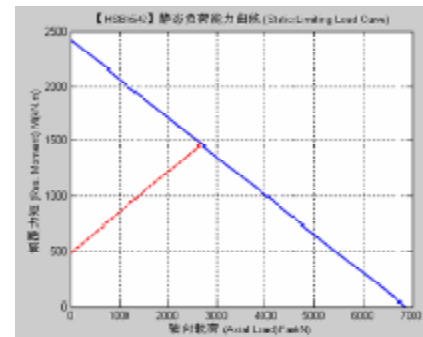

Figure A-35

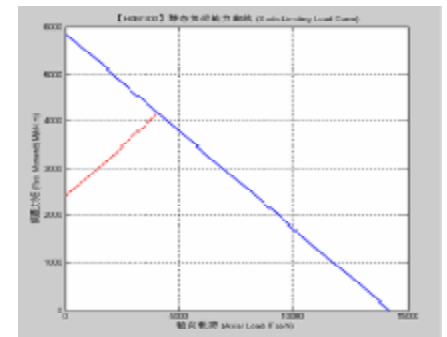

Figure A-36

Appendix A Slewing Bearing Load Curve

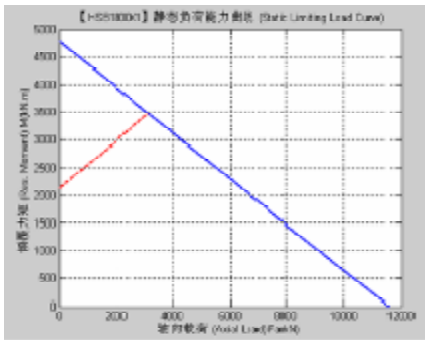

Figure A-37

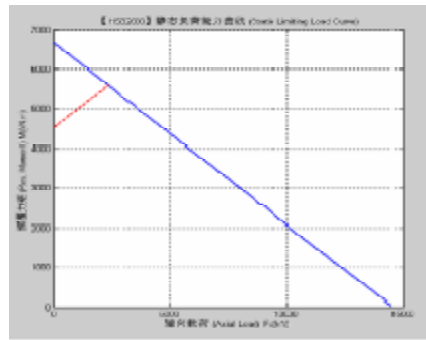

Figure A-38

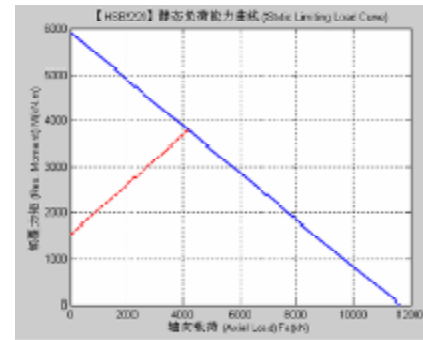

Figure A-43

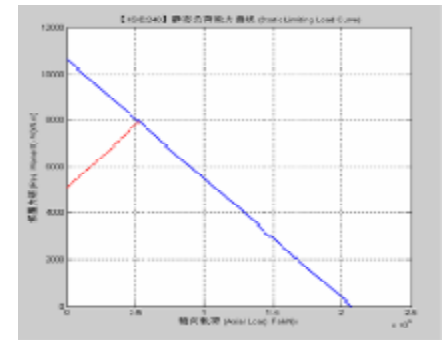

Figure A-44

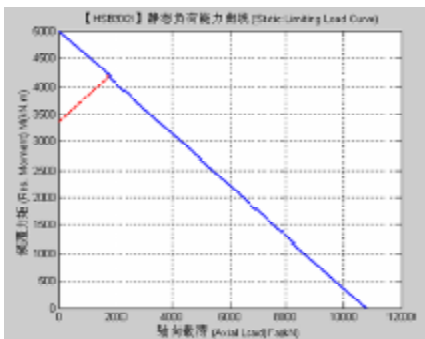

Figure A-39

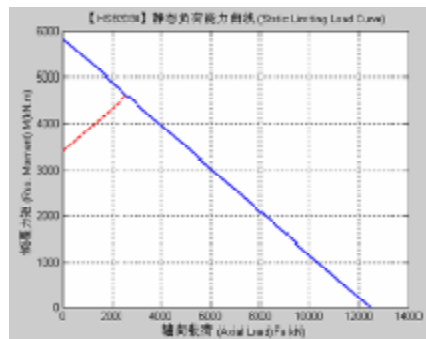

Figure A-40

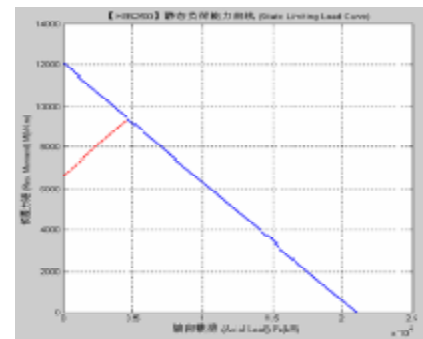

Figure A-45

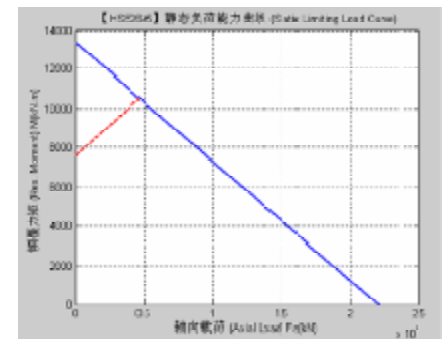

Figure A-46

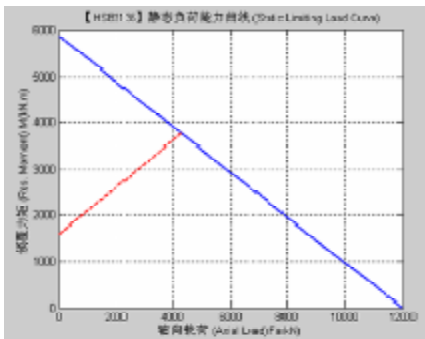

Figure A-41

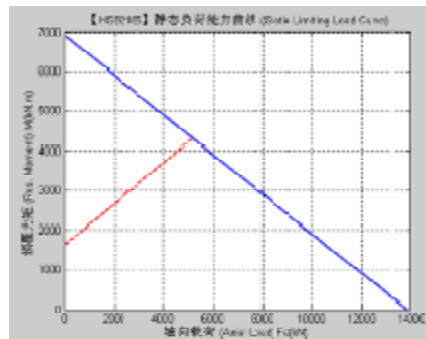

Figure A-42

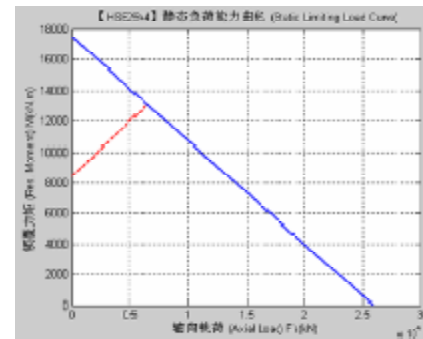

Figure A-47

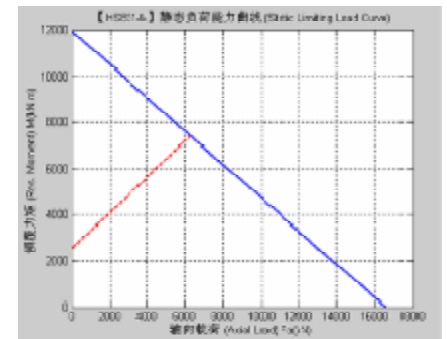

Figure A-48

Appendix A Slewing Bearing Load Curve

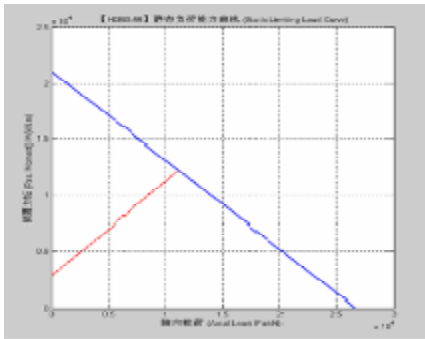

Figure A-49

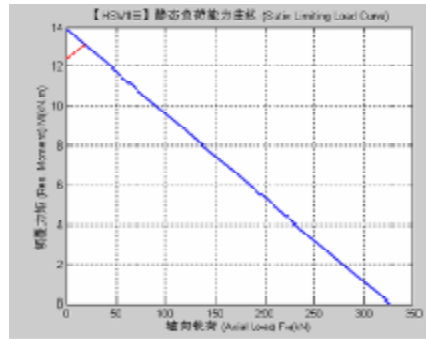

Figure A-50

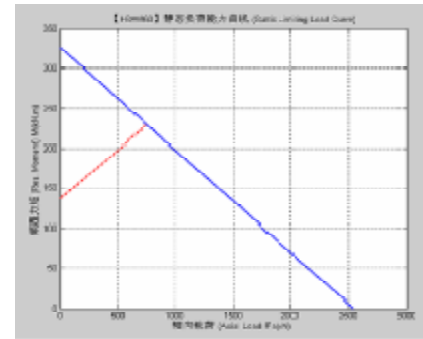

Figure A-55

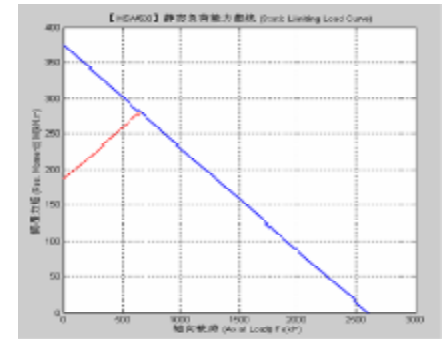

Figure A-56

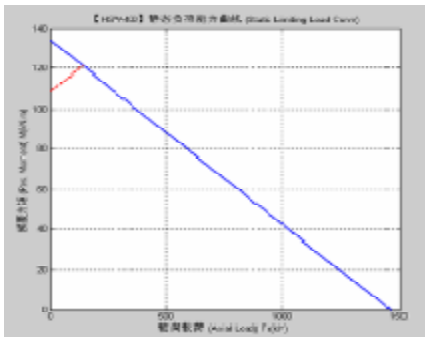

Figure A-51

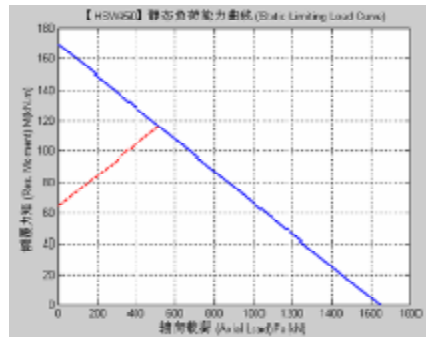

Figure A-52

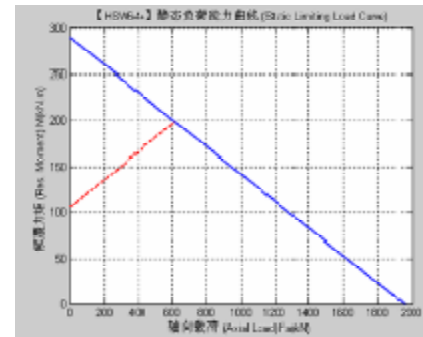

Figure A-57

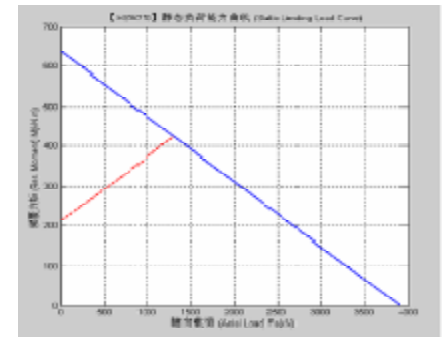

Figure A-58

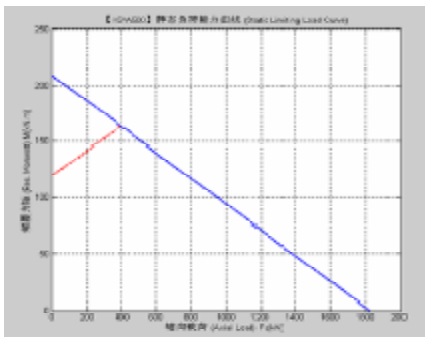

Figure A-53

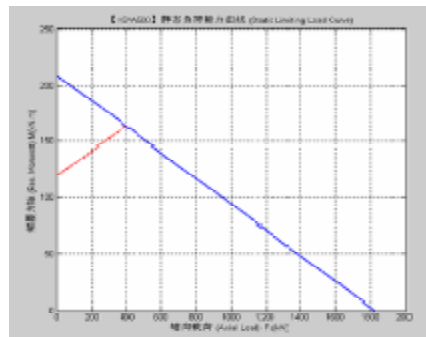

Figure A-54

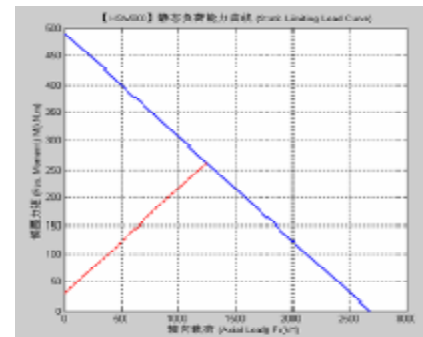

Figure A-59

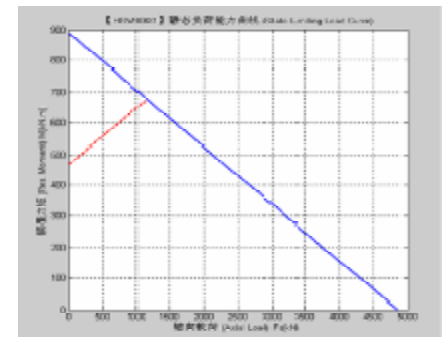

Figure A-60

Appendix A Slewing Bearing Load Curve

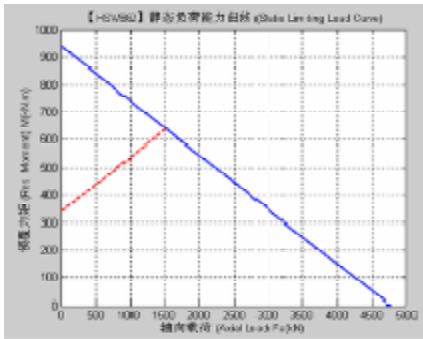

Figure A-61

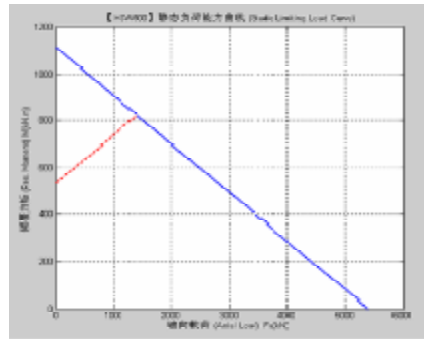

Figure A-62

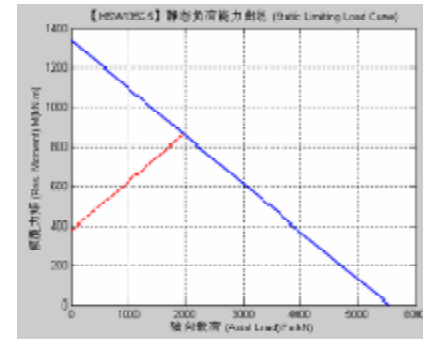

Figure A-67

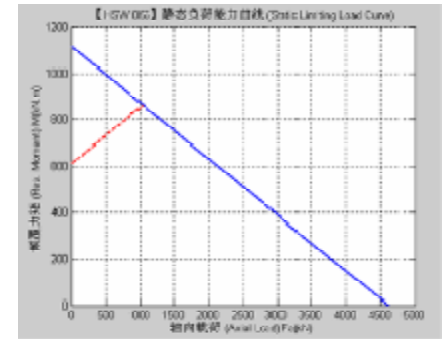

Figure A-68

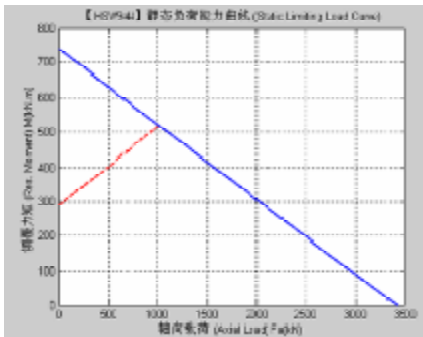

Figure A-63

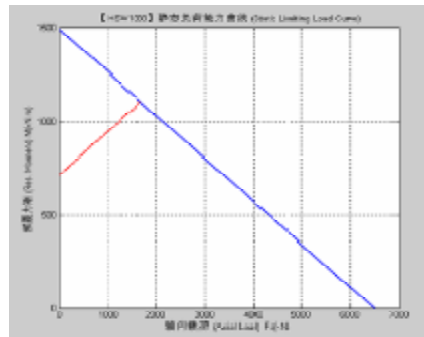

Figure A-64

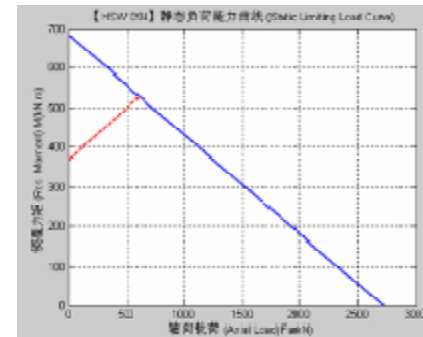

Figure A-69

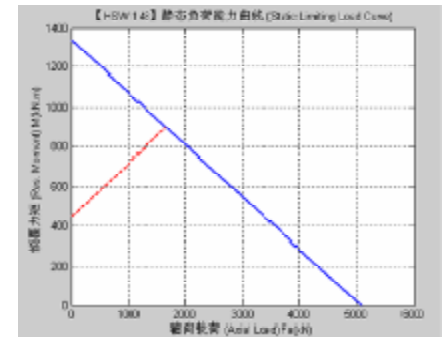

Figure A-70

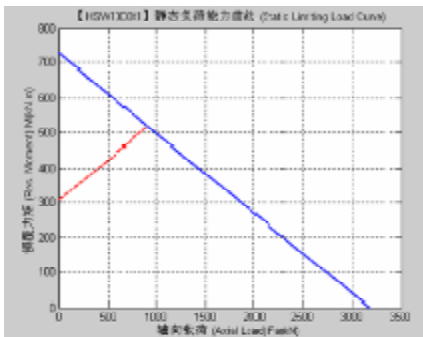

Figure A-65

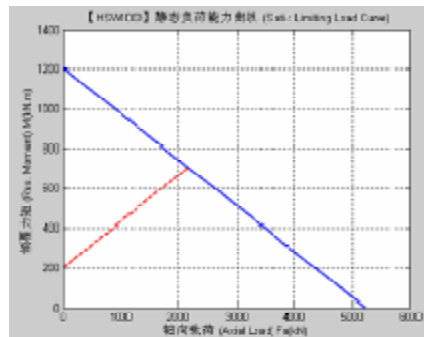

Figure A-66

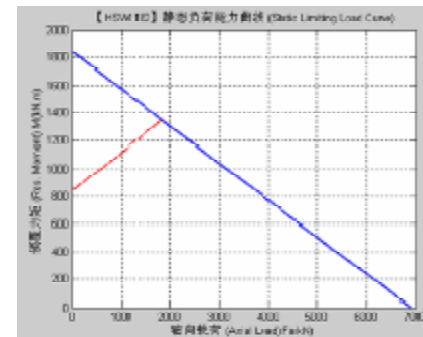

Figure A-71

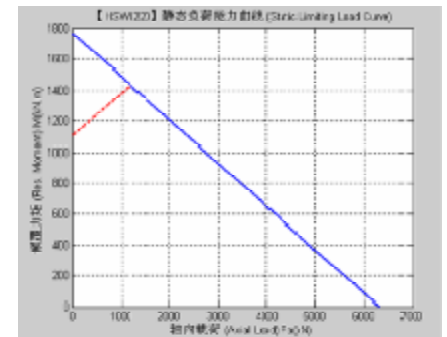

Figure A-72

Appendix A Slewing Bearing Load Curve

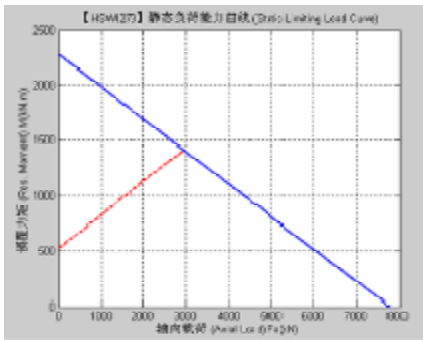

Figure A-73

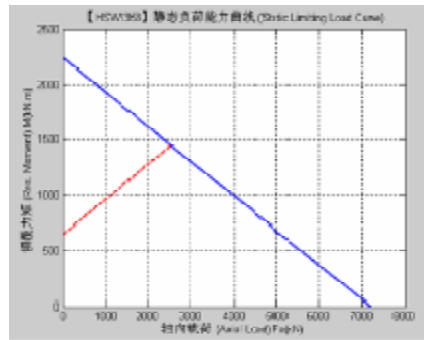

Figure A-74

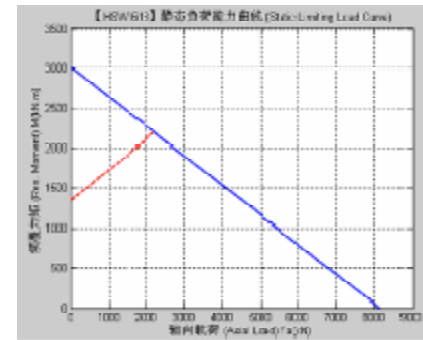

Figure A-79

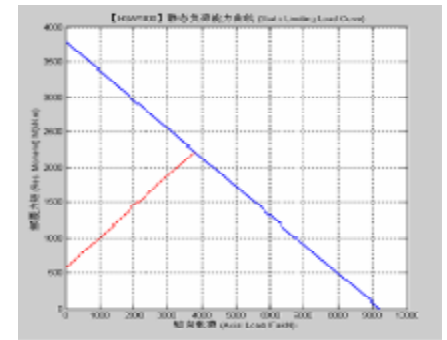

Figure A-80

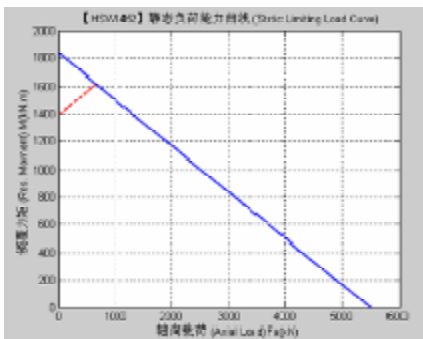

Figure A-75

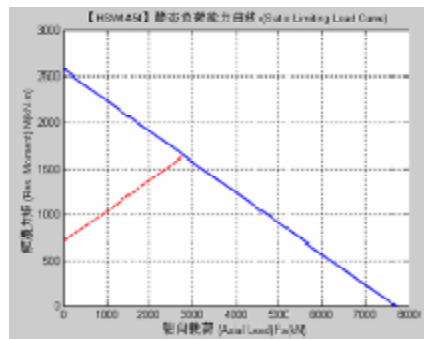

Figure A-76

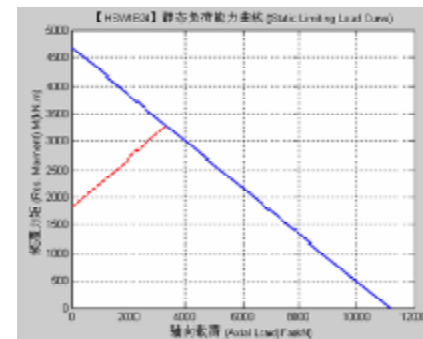

Figure A-81

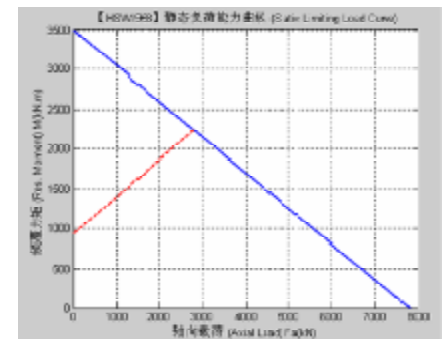

Figure A-82

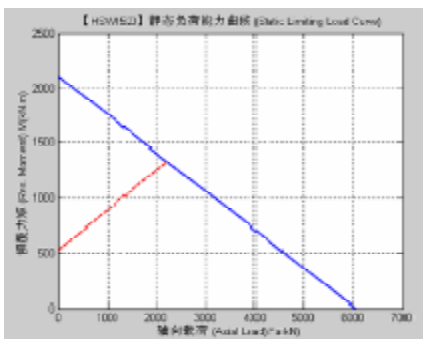

Figure A-77

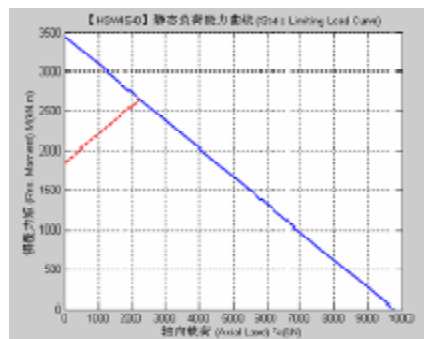

Figure A-78

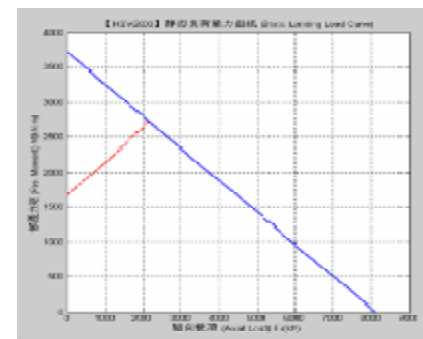

Figure A-83

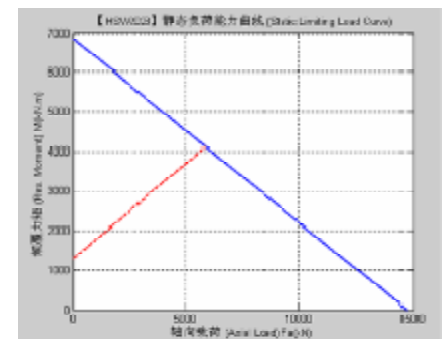

Figure A-84

Appendix A Slewing Bearing Load Curve

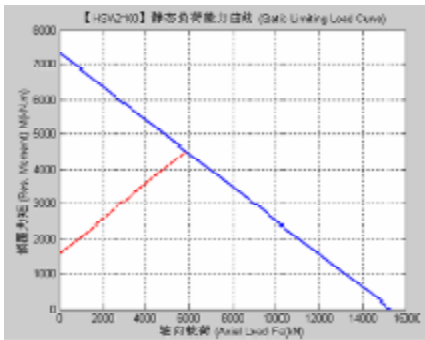

Figure A-85

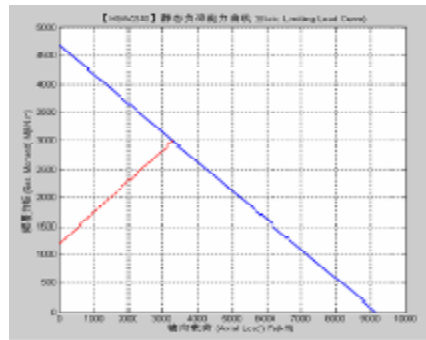

Figure A-86

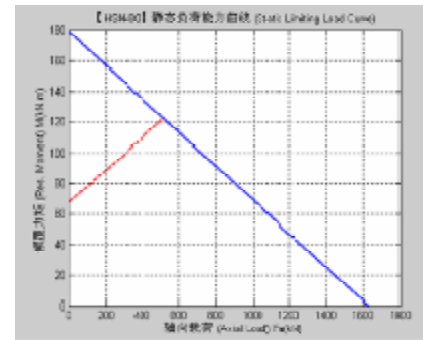

Figure A-91

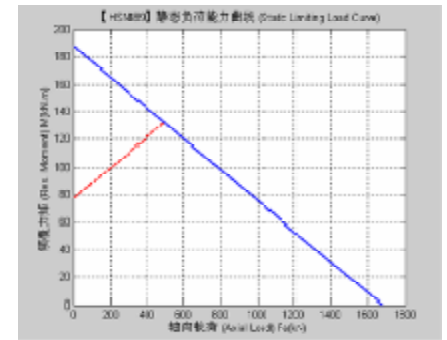

Figure A-92

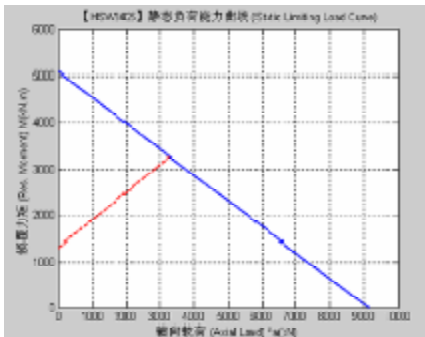

Figure A-87

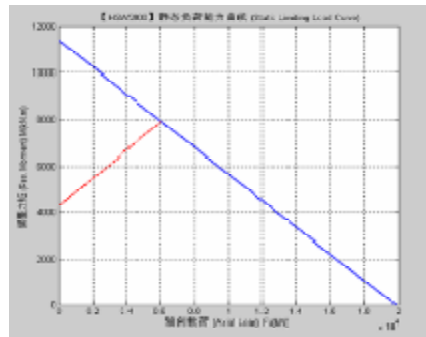

Figure A-88

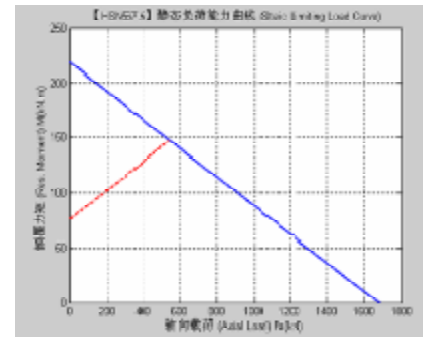

Figure A-93

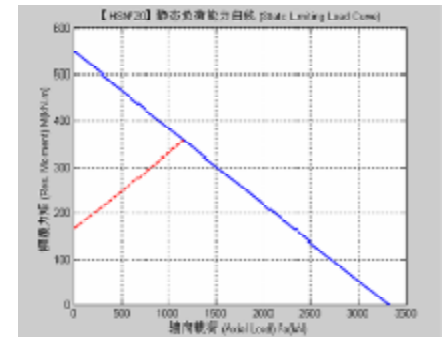

Figure A-94

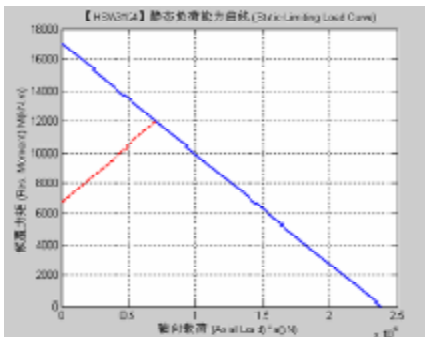

Figure A-89

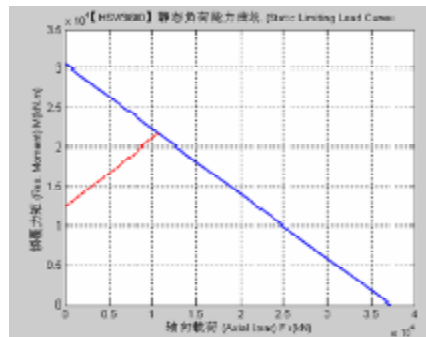

Figure A-90

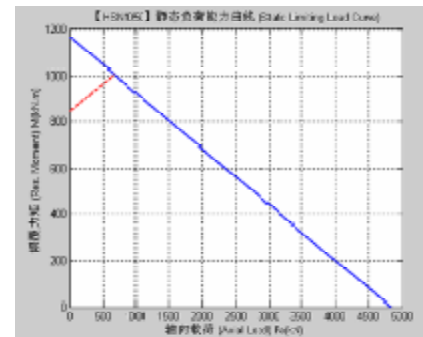

Figure A-95

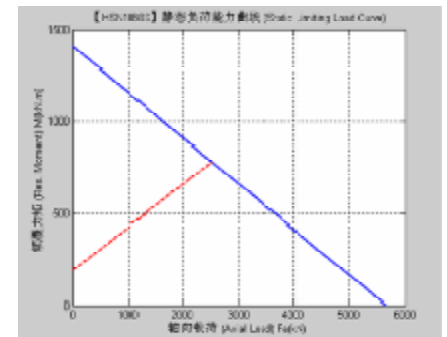

Figure A-96

Appendix A Slewing Bearing Load Curve

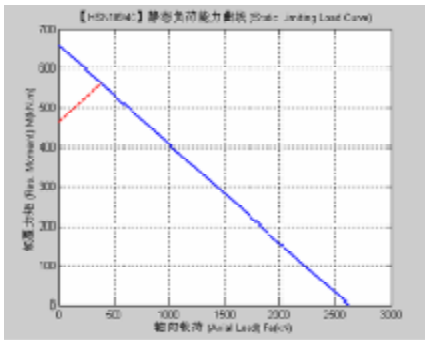

Figure A-97

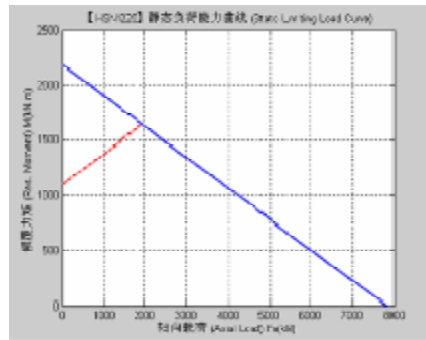

Figure A-98

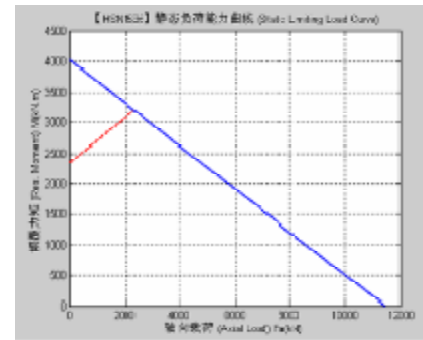

Figure A-103

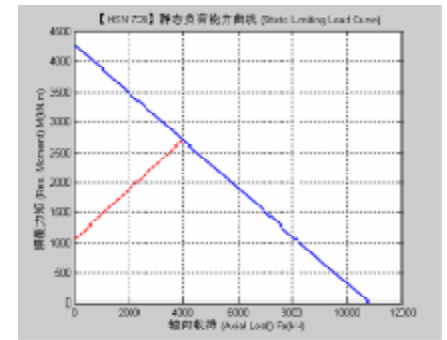

Figure A-104

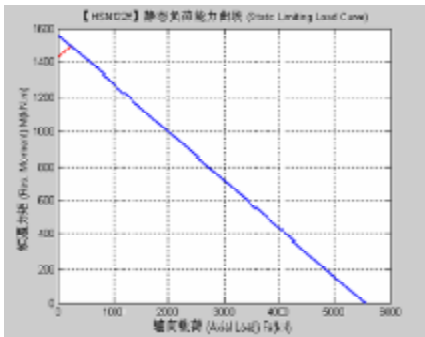

Figure A-99

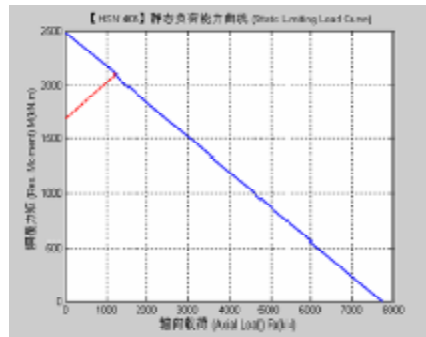

Figure A-100

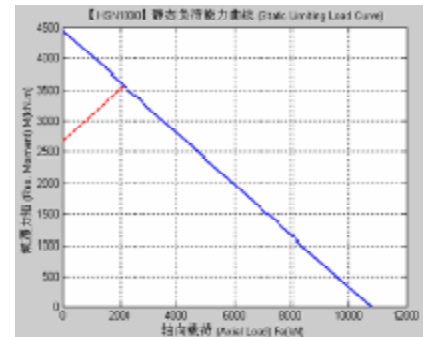

Figure A-105

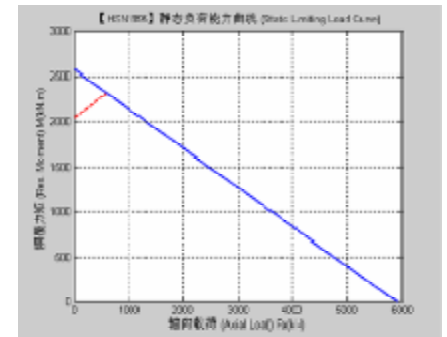

Figure A-106

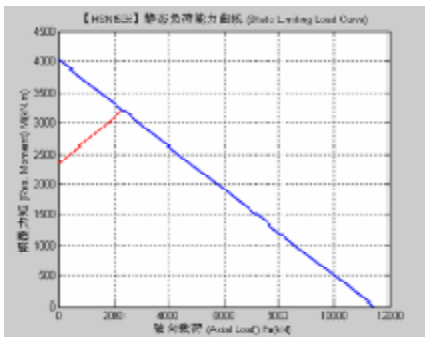

Figure A-101

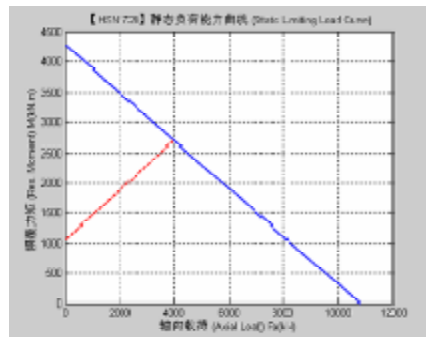

Figure A-102

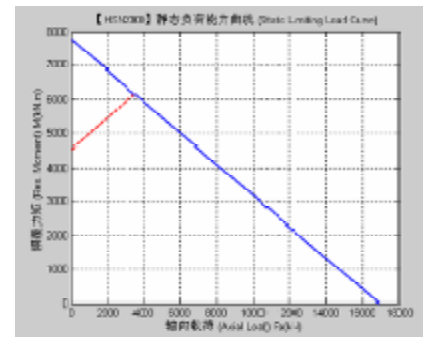

Figure A-107

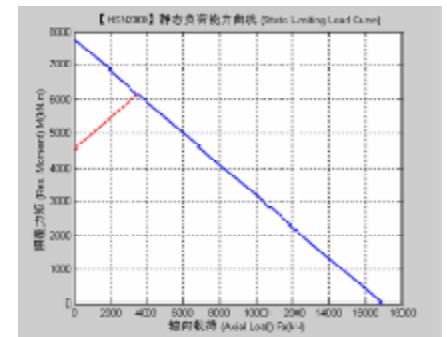

Figure A-108

Appendix A Slewing Bearing Load Curve

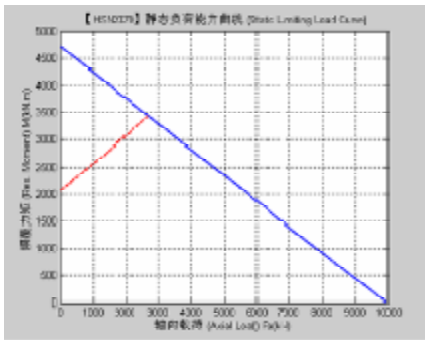

Figure A-109

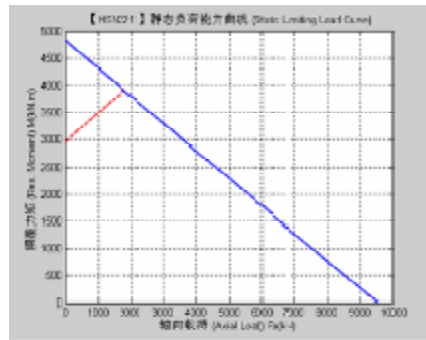

Figure A-110

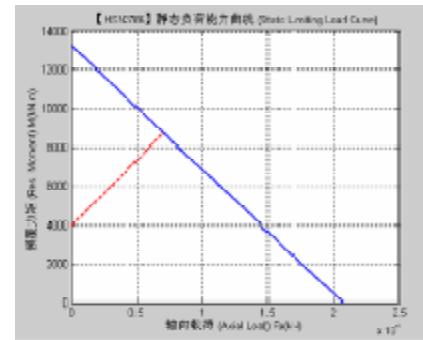

Figure A-115

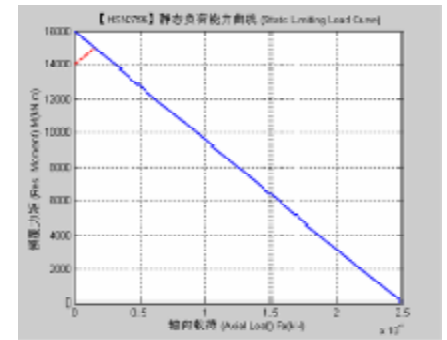

Figure A-116

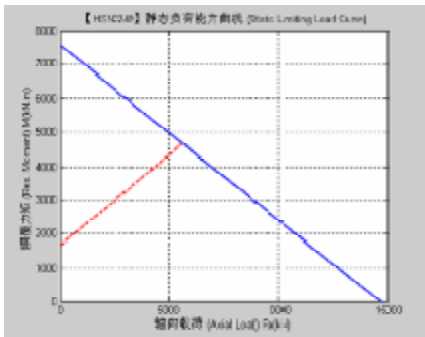

Figure A-111

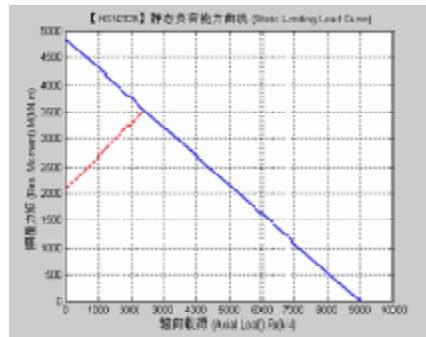

Figure A-112

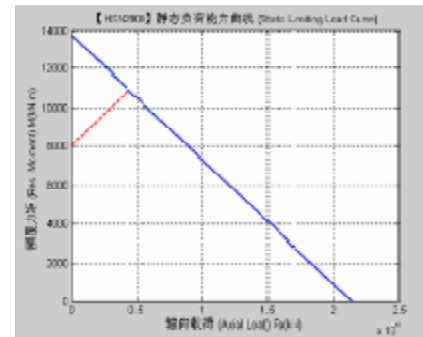

Figure A-117

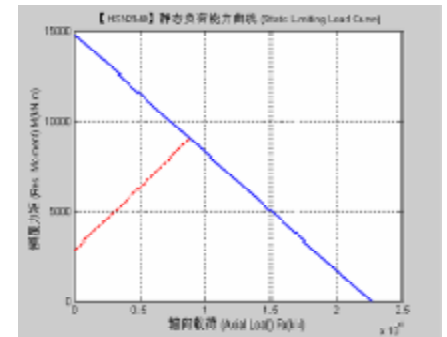

Figure A-118

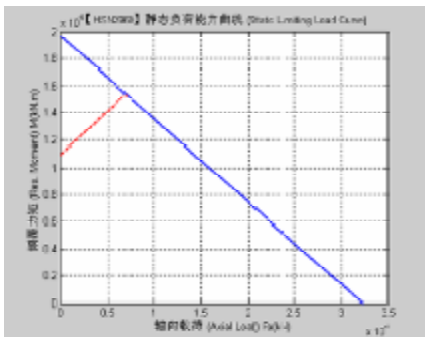

Figure A-113

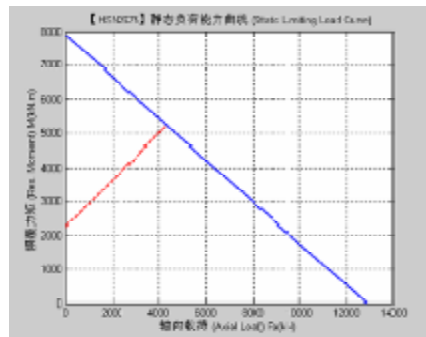

Figure A-114

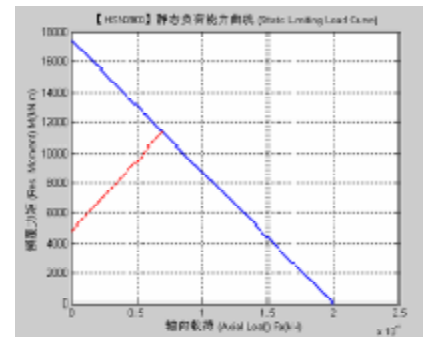

Figure A-119

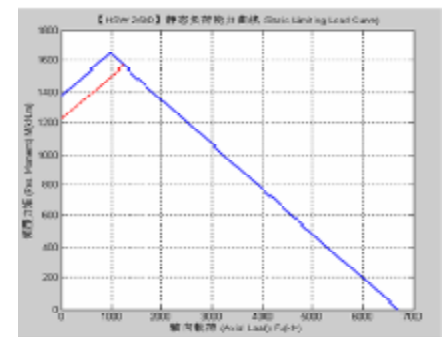

Figure A-120

Appendix A Slewing Bearing Load Curve

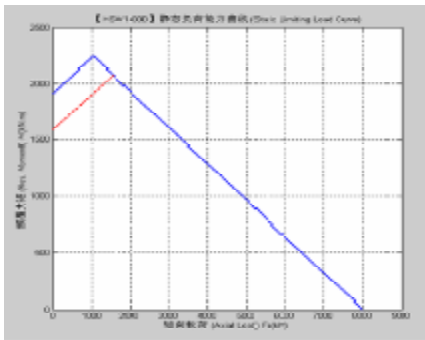

Figure A-121

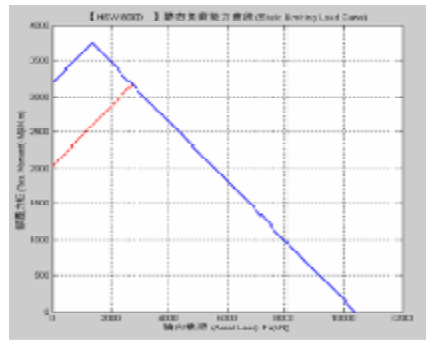

Figure A-122

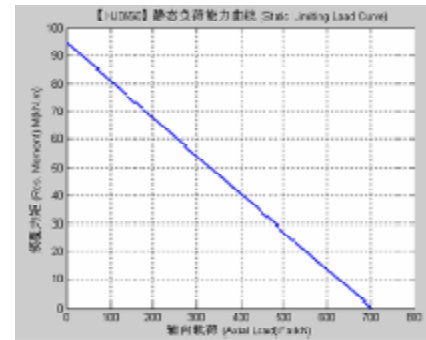

Figure A-127

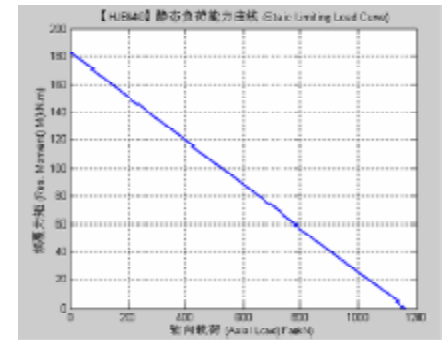

Figure A-128

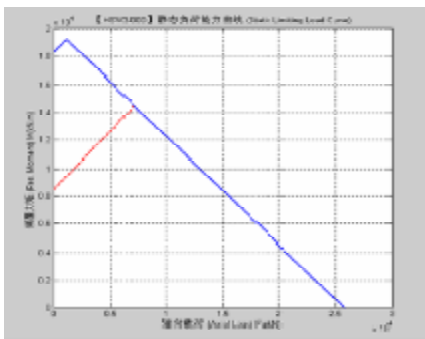

Figure A-123

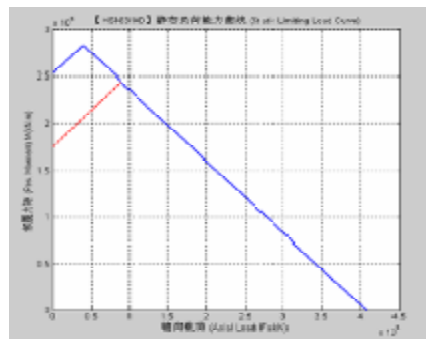

Figure A-124

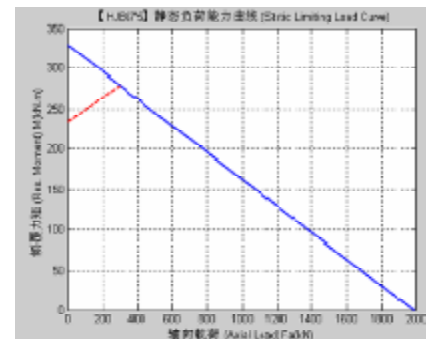

Figure A-129

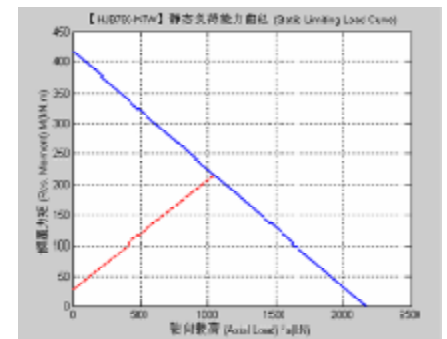

Figure A-130

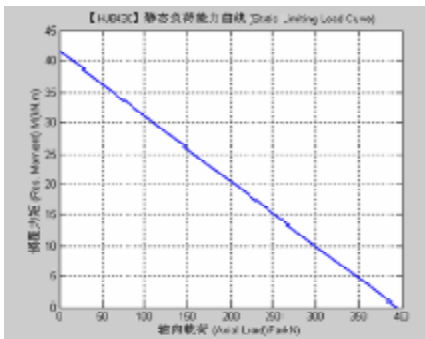

Figure A-125

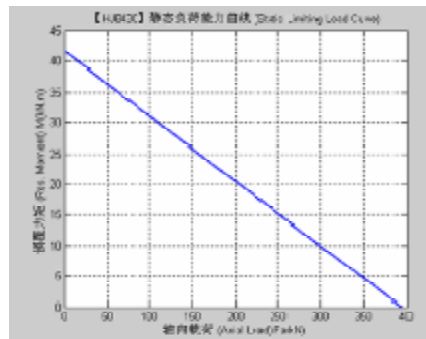

Figure A-126

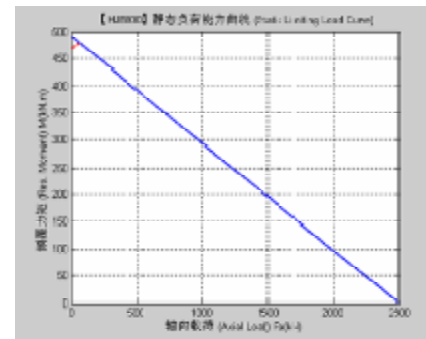

Figure A-131

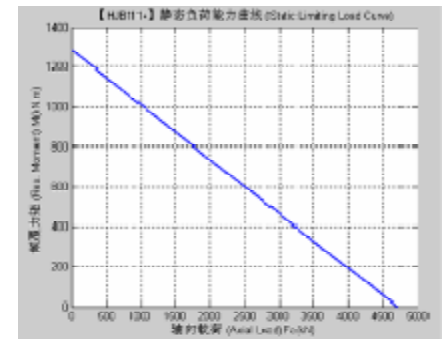

Figure A-132

Appendix A Slewing Bearing Load Curve

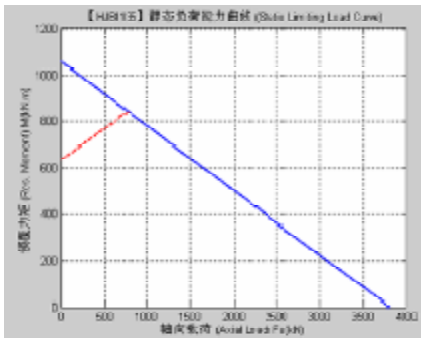

Figure A-133

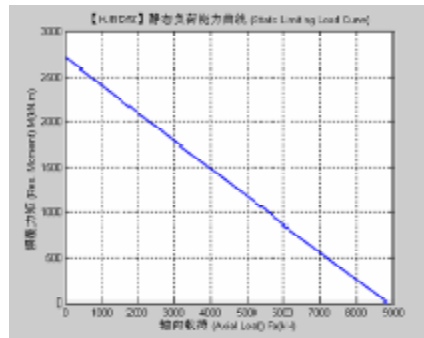

Figure A-134

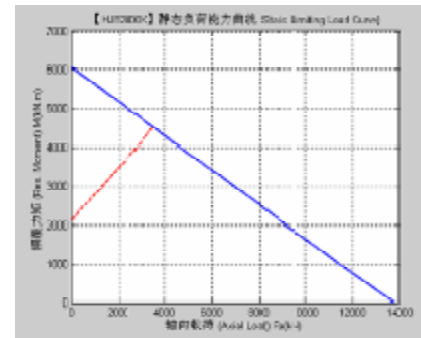

Figure A-139

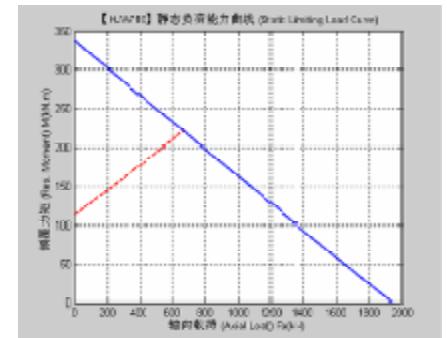

Figure A-140

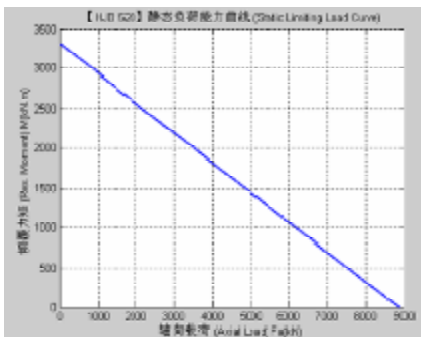

Figure A-135

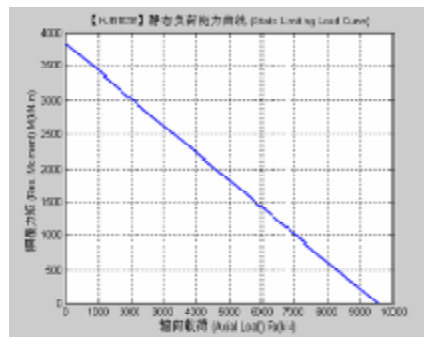

Figure A-136

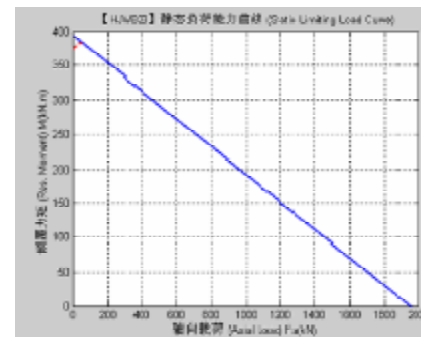

Figure A-141

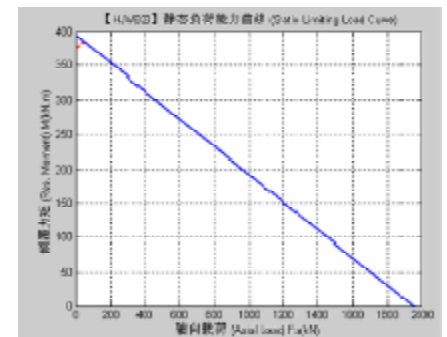

Figure A-142

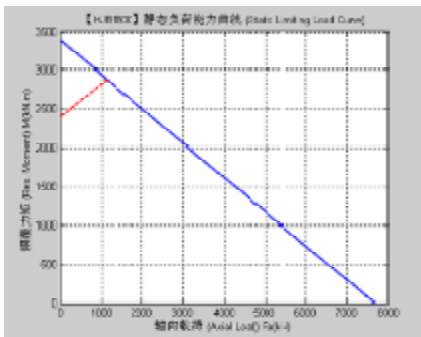

Figure A-137

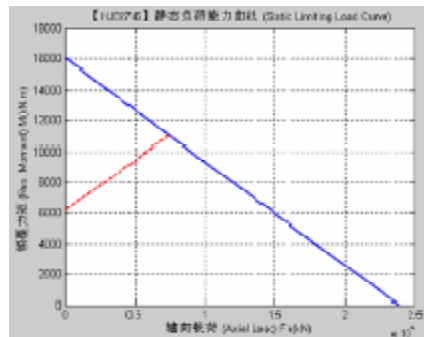

Figure A-138

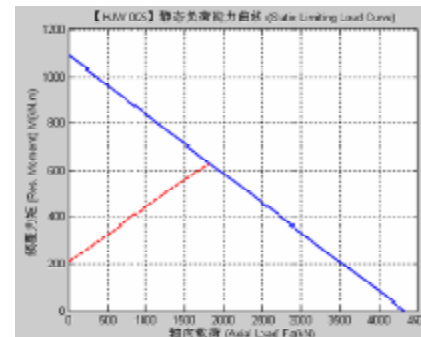

Figure A-143

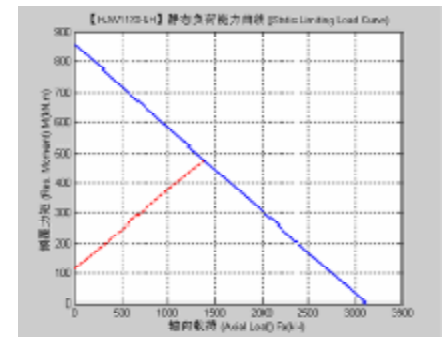

Figure A-144

Appendix A Slewing Bearing Load Curve

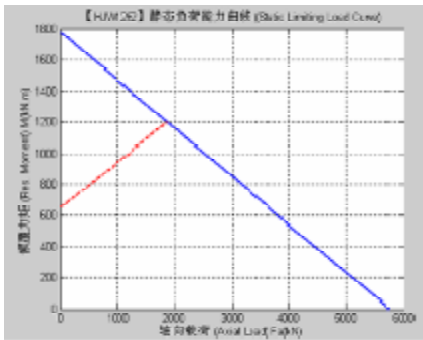

Figure A-145

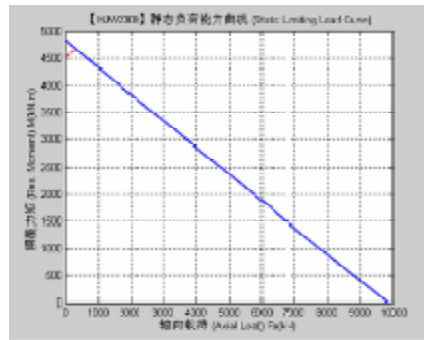

Figure A-146

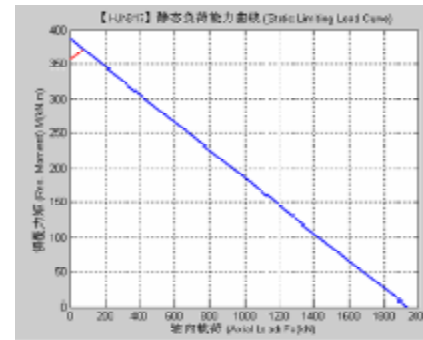

Figure A-151

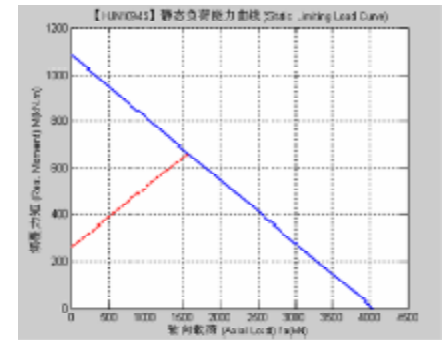

Figure A-152

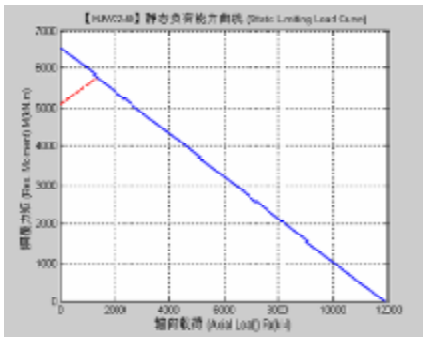

Figure A-147

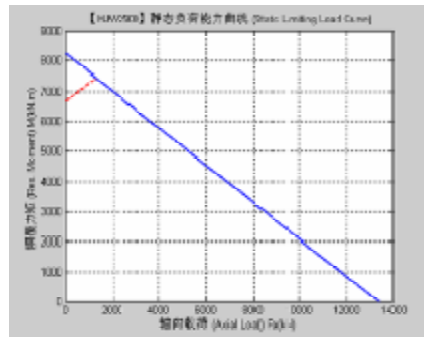

Figure A-148

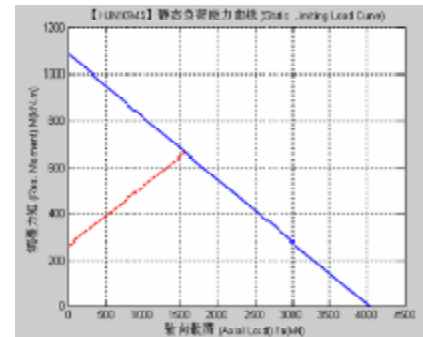

Figure A-153

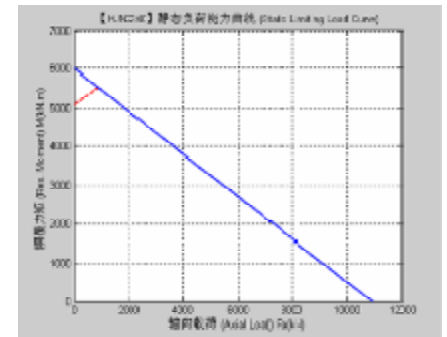

Figure A-154

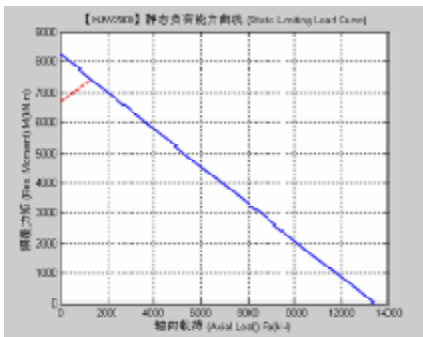

Figure A-149

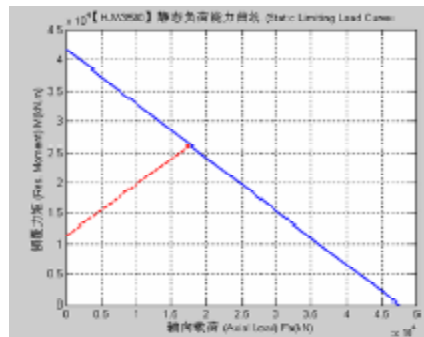

Figure A-150

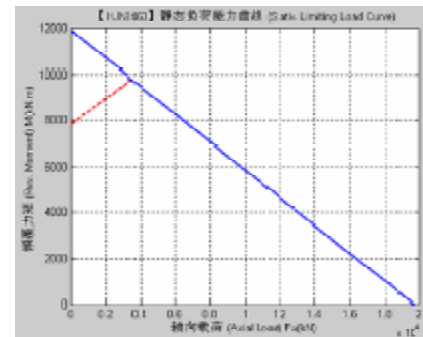

Figure A-155

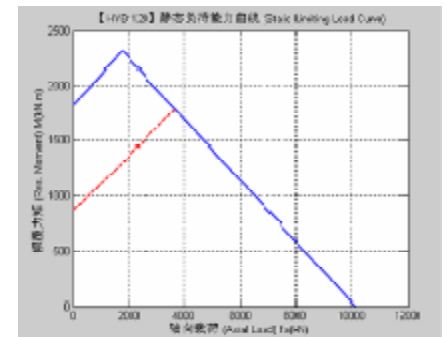

Figure A-156

Appendix A Slewing Bearing Load Curve

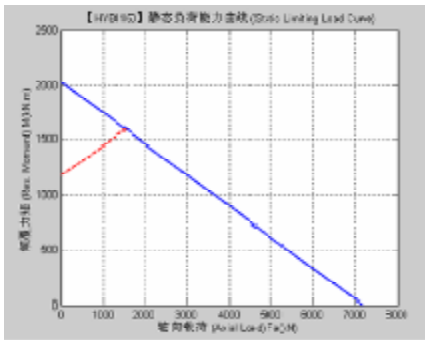

Figure A-157

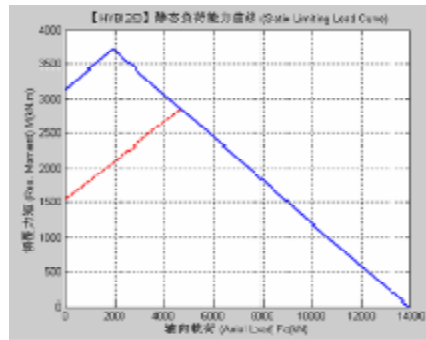

Figure A-158

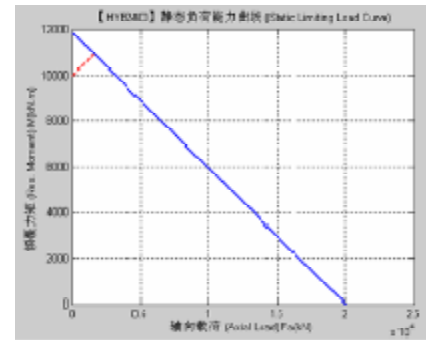

Figure A-163

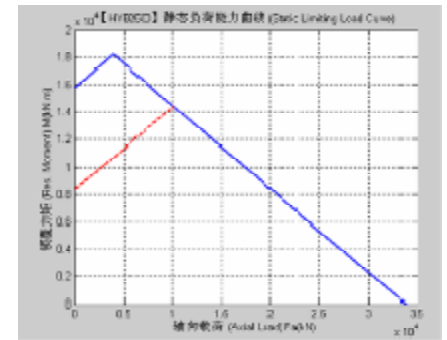

Figure A-164

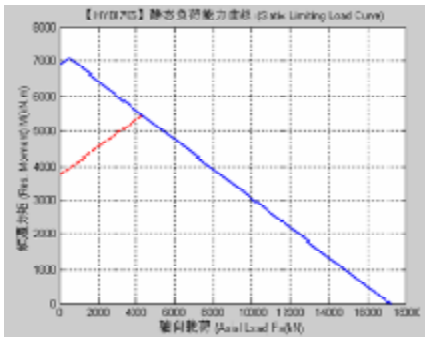

Figure A-159

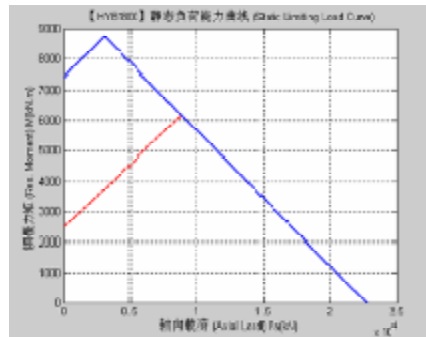

Figure A-160

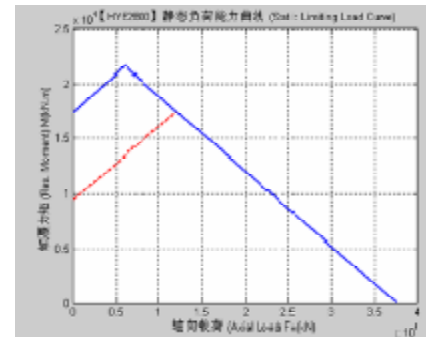

Figure A-165

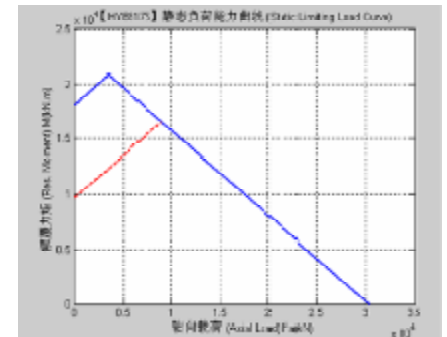

Figure A-166

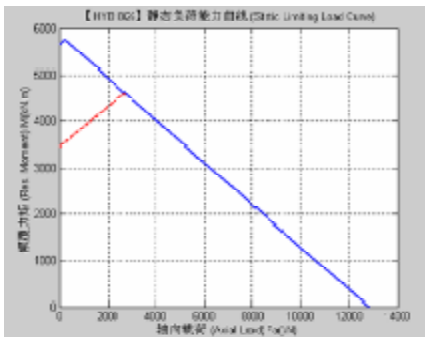

Figure A-161

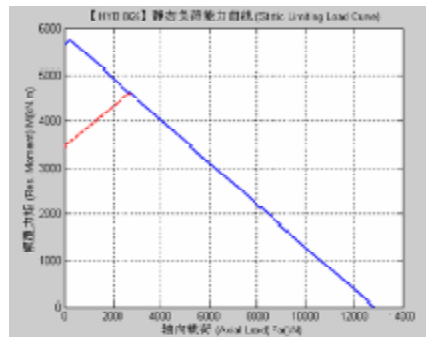

Figure A-162

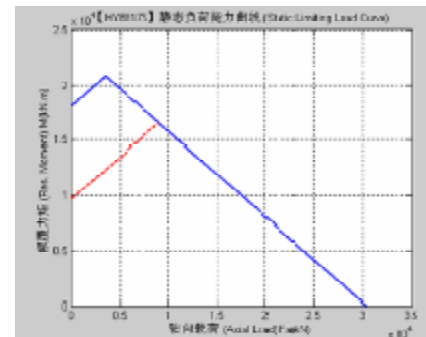

Figure A-167

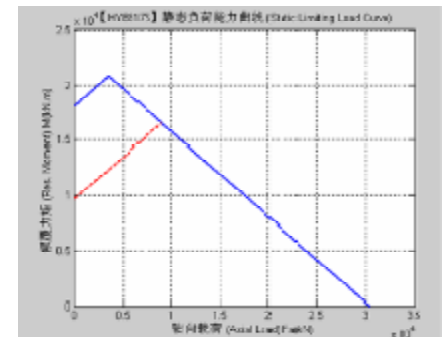

Figure A-168

Appendix A Slewing Bearing Load Curve

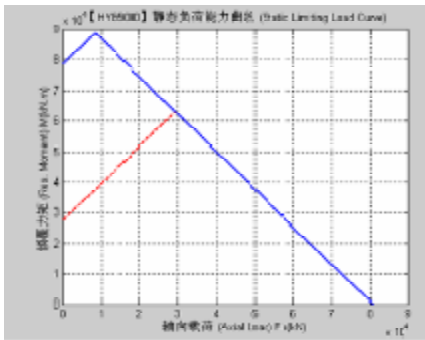

Figure A-169

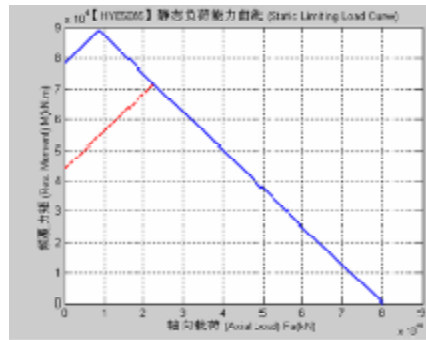

Figure A-170

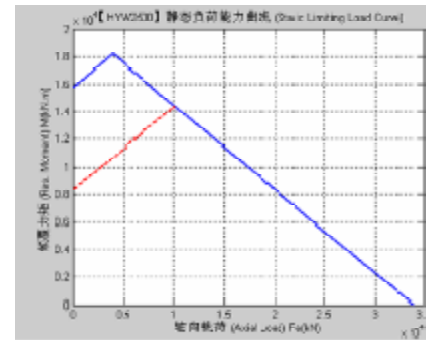

Figure A-175

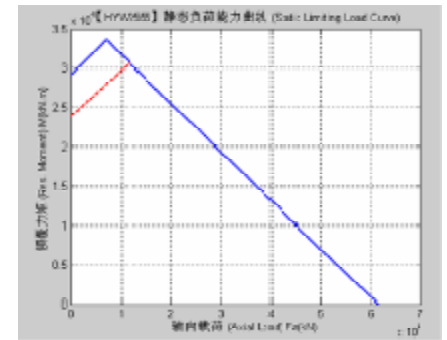

Figure A-176

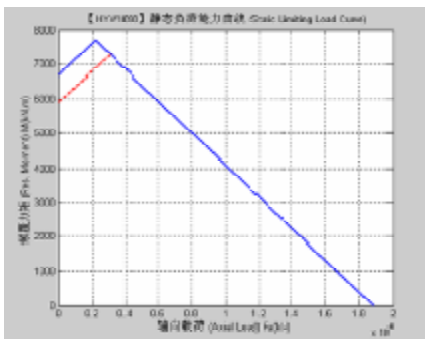

Figure A-171

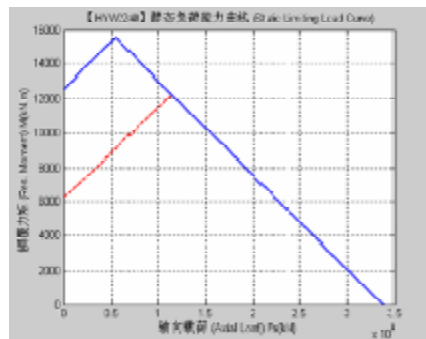

Figure A-172

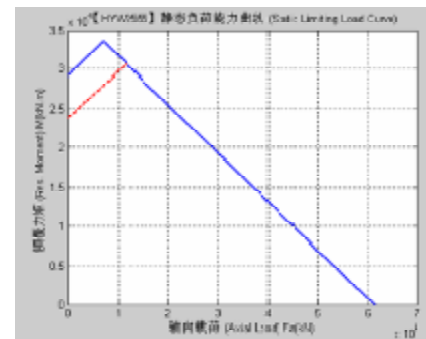

Figure A-177

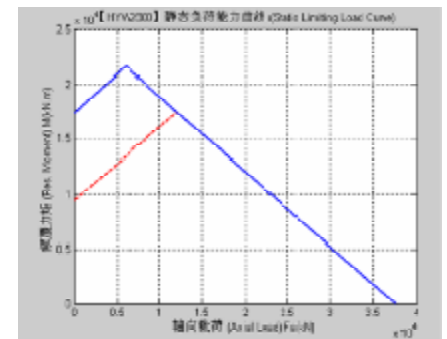

Figure A-178

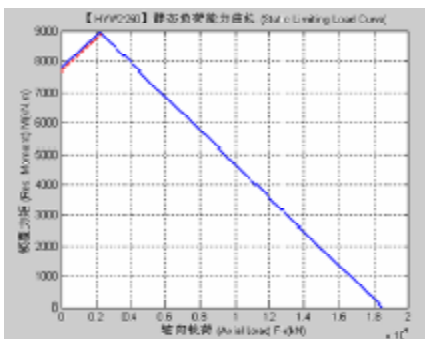

Figure A-173

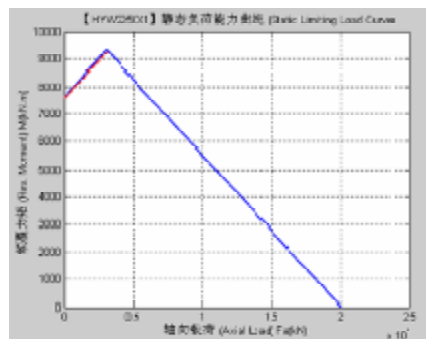

Figure A-174

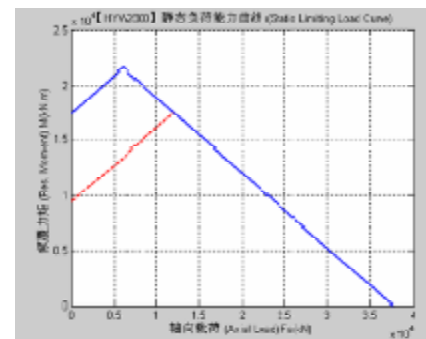

Figure A-179

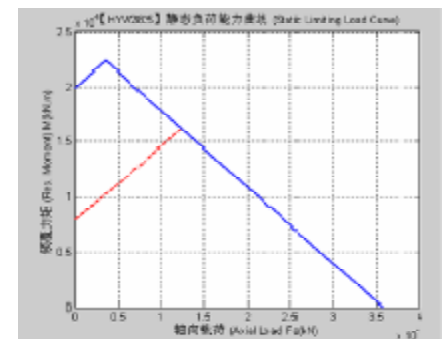

Figure A-180

Appendix A Slewing Bearing Load Curve

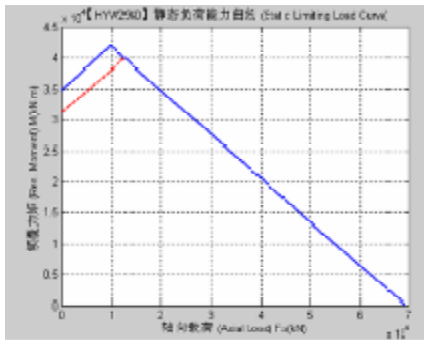

Figure A-181

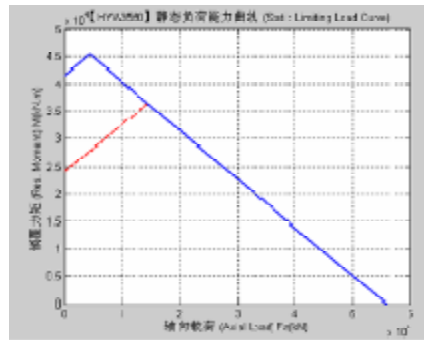

Figure A-182

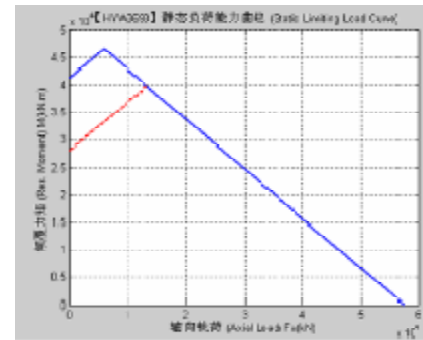

Figure A-187

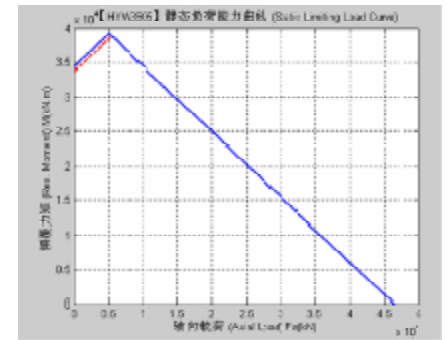

Figure A-188

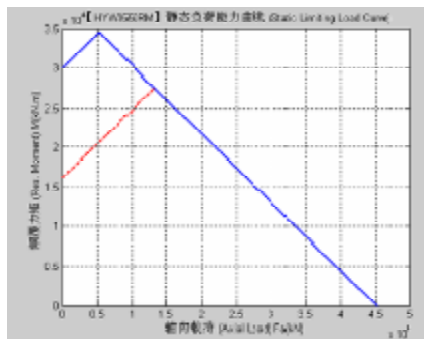

Figure A-183

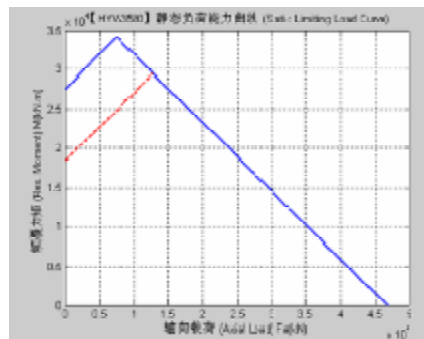

Figure A-184

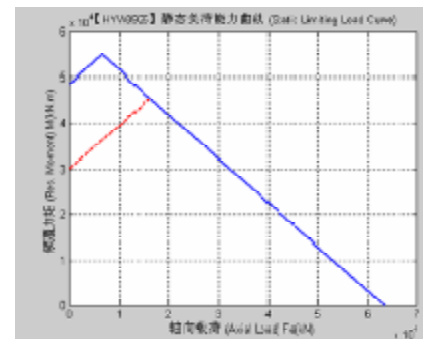

Figure A-189

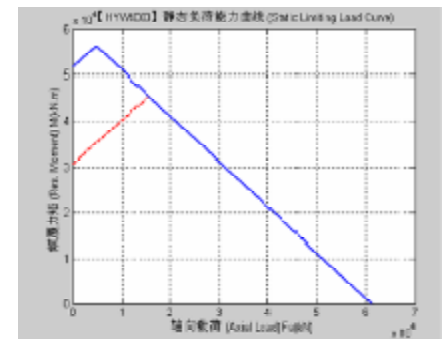

Figure A-190

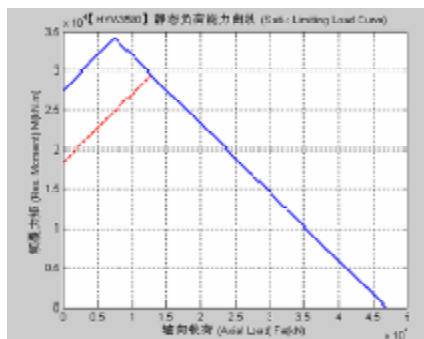

Figure A-185

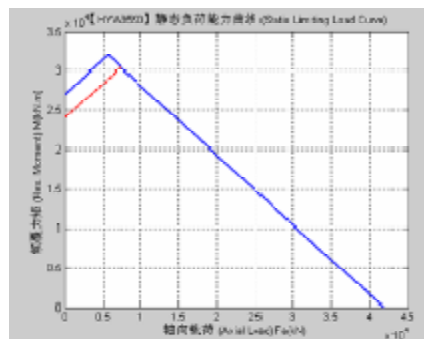

Figure A-186

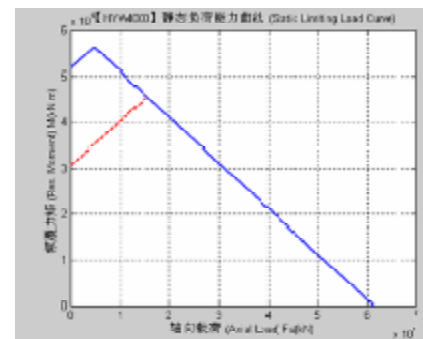

Figure A-191

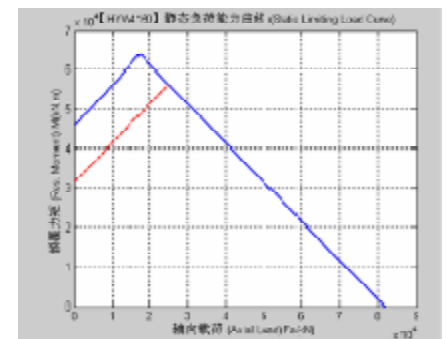

Figure A-192

Appendix A Slewing Bearing Load Curve

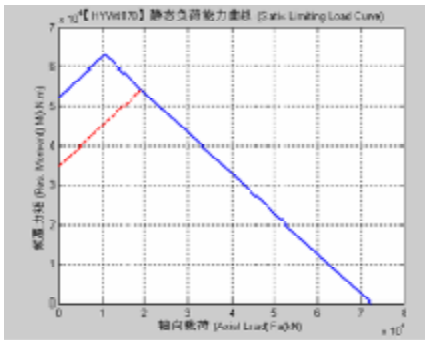

Figure A-193

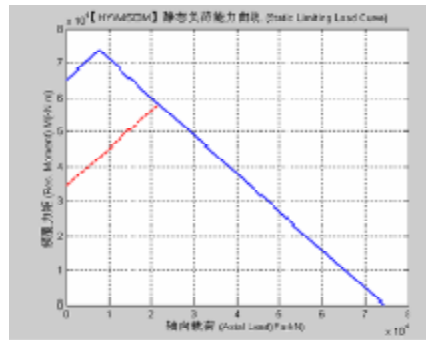

Figure A-194

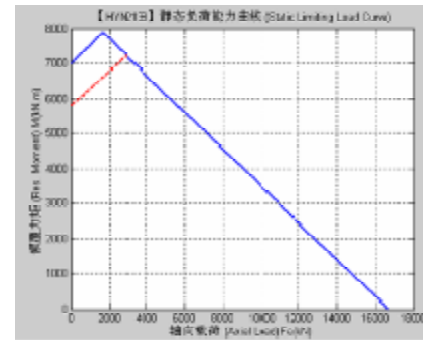

Figure A-199

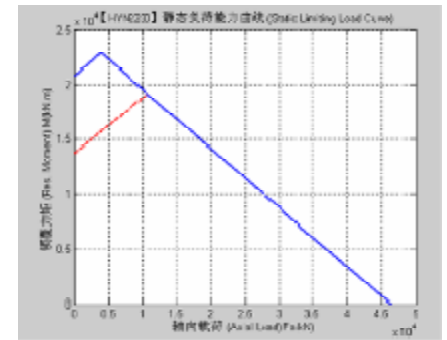

Figure A-200

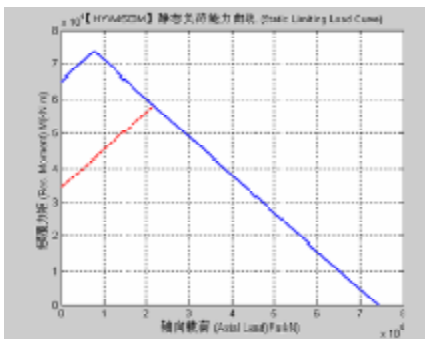

Figure A-195

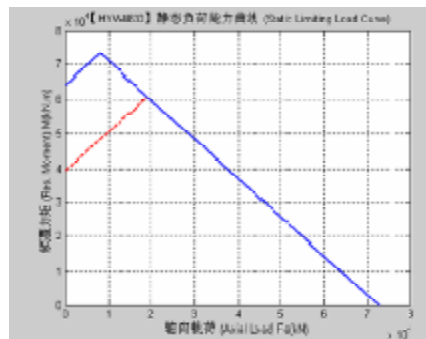

Figure A-196

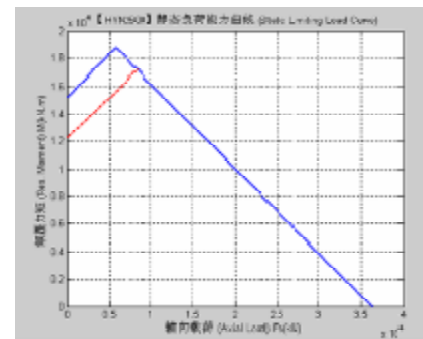

Figure A-201

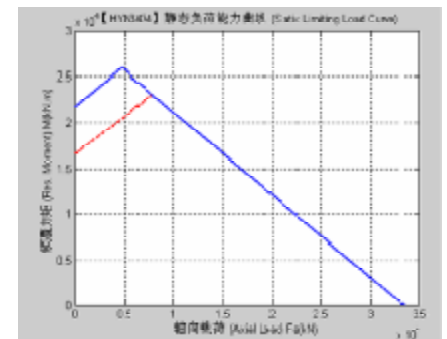

Figure A-202

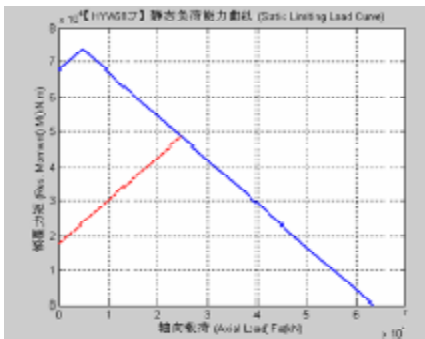

Figure A-197

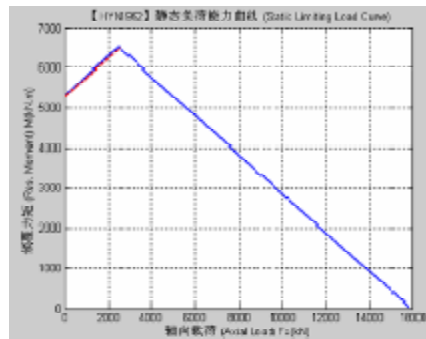

Figure A-198

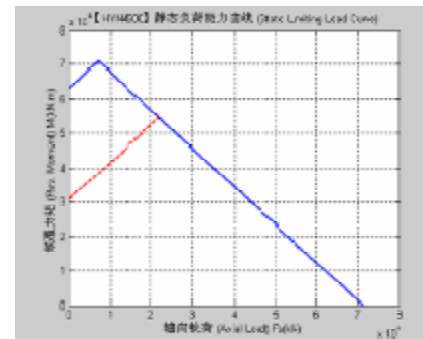

Figure A-203

Bearing Appendix

Concise Comparison of New and Old Bearing Code System

This comparison is according to the type, structure, diameter series, width series as index, organized accordingly. Compares the bearing old and new designations which comply with boundary dimensions comply with standard requirement.

"0" Deep groove ball bearing

Series		Example	
Old designation	New Designation	Old designation	New Designation
0000 type Deep groove ball bearing			
1000800	61800	1000838	61838
1000900	61900	1000918	61918
7000100	16000	7000115	16015
100	6000	116	6016
200	6200	208	6208
3000200	63200	3000210	63210
300	6300	309	6309
400	6400	422	6422
50000 type Deep groove ball bearing outer ring with snap groove			
50100	6100N	50106	6106N
50200	6200N	50218	6218N
50300	6300N	50310	6310N
50400	6400N	50420	6420N
60000 type Deep groove ball bearing one side shield			
1060900	61900-Z	1060905	61905-Z
60100	6000-Z	60120	6020-Z
60200	6200-Z	60203	6203-Z
60300	6300-Z	60308	6308-Z
80000 type Deep groove ball bearing double side shield			
80100	6000-2Z	80115	6015-2Z
80200	6200-2Z	80205	6205-2Z
80300	6300-2Z	80308	6308-2Z
150000 type Deep groove ball bearing one side shield, other side with snap groove			
150200	6200-ZN	150215	6215-ZN
150300	6300-ZN	150310	6310-ZN
150400	6400-ZN	150404	6404-ZN

"0" Deep groove ball bearing

Series		Example	
Old designation	New Designation	Old designation	New Designation
160000 Type Deep groove ball bearing one side with sealing ring			
160100	6000-RS	160112	6012-RS
160200	6200-RS	160212	6212-RS
160300	6300-RS	160308	6308-RS
160500	62200-RS	160505	62205-RS
180000 Type Deep groove ball bearing double side with sealing ring			
180100	6000-2RS	180112	6012-2RS
180200	6200-2RS	180216	6216-2RS
3180200	63200-2RS	3180210	63210-2RS
180300	6300-2RS	180311	6311-2RS
180500	62200-2RS	180516	62216-2RS
180600	62300-2RS	180609	62309-2RS
250000 Type Deep groove ball bearing double side with shield outer ring with snap groove			
250200	6200-2ZN	250211	6211-2ZN
350000 Type Deep groove ball bearing one side with sealing ring, other side outer ring with snap groove.			
350500	62200-RSN	350505	62205-RSN
370000 Type Deep groove ball bearing with filling slot			
370200	200	370213	213
370300	300	370310	310
370400	400	370401	401
370000 Type Deep groove ball bearing with filling slot			
370200	200	370213	213
370300	300	370310	310
370400	400	370401	401

Bearing Appendix

"1" Self-aligning ball bearing

Series		Example	
Old designation	New Designation	Old designation	New Designation
1000 type Self-aligning ball bearing			
1200	1200	1212	1212
1300	1300	1314	1314
1400	1400	1412	1412
1500	2200	1520	2220
1600	2300	1615	2300
111000 type Self-aligning ball bearing with tapered bore			
111200	1200K	111214	1214K
111300	1300K	111316	1316K
111500	2200K	111518	2218K
111600	2300K	111618	2318K
11000 type Self-aligning ball bearing with adapter sleeve			
1060900	61900-Z	1060905	61905-Z
60100	6000-Z	60120	6020-Z
60200	6200-Z	60203	6203-Z
60300	6300-Z	60308	6308-Z
80000 type Deep groove ball bearing with double side shield			
Old designation		New Designation	
11204		1205K+H205	
11205		1206K+H206	
11206		1207K+H207	
11207		1208K+H208	
11209		1210K+H210	
11210		1211K+H211	
11211		1212K+H212	
11212		1213K+H213	
11305		1306K+H306	
11609		2310K+H2310	

"2" Cylindrical roller bearing

Series		Example	
Old designation	New Designation	Old designation	New Designation
32000 Type Cylindrical roller bearing outer ring with double flange, inner ring without flange			
1032900	NU 1900	1032948	NU 1948
2032900	NU 2900	2032944	NU 2944
32100	NU 1000	32124	NU 1024
3032100	NU 3000	3032134	NU 3034
3032200	NU 3200	3032224	NU 3224
32300	NU 300	32316	NU 316
3032300	NU 3300	3032315H	NU 3315 M
32400	NU 400	32426	NU 426
32500	NU 2200	32538	NU 2238
32600	NU 2300	32636	NU 2336
332000 Type Cylindrical roller bearing with tapered bore			
332100	NU 1000 K	332180	NU 1080 K
2000Type Cylindrical roller bearing outer ring without flange			
2002800	N 2800	20028/530	N 28/530
1002900	N 1900	1002934	N 1934
7002100	N 0000	7002158	N 0058
2100	N 1000	2152	N 1052
2200	N 200	2244	N 244
2300	N 300	2324	N 324
2400	N 400	2418	N 418
2500	N 2200	2526	N 2226
2600	N 2300	2640	N 2340
12000Type Cylindrical roller bearing outer ring with single flange			
1012900	NF 1900	1012936	NF 1936
2012800	NF 2800	20128/530	NF 28/530
12100	NF1000	12121	NF1021
12200	NF 200	12220	NF 220
12300	NF 300	12328	NF 328
12400	NF 400	12410	NF 410
12500	NF 2200	12526	NF 2226
12600	NF 2300	12630	NF 2330

Bearing Appendix

"2" Cylindrical roller bearing

Series		Example	
Old designation	New Designation	Old designation	New Designation
22000 type Cylindrical roller bearing outer ring with single rib and with loose rib			
3022800	NFP 3800	30228/630	NFP 38/630
22300	NFP 300	22317	NFP 317
42000 type Cylindrical roller bearing inner ring with single flange			
42100	NJ 1000	42144	NJ 1044
42200	NJ 200	42236	NJ 236
42300	NJ 300	42330	NJ 330
42400	NJ 400	42428	NJ 428
42500	NJ 2200	42544	NJ 2244
42600	NJ 2300	42636	NJ 2336
52000 type Cylindrical roller bearing inner ring without flange, with separate thrust collar			
52200	NU 200+HJ 200	52244	NU 200+HJ 244
52300	NU 300+HJ 300	52340	NU 300+HJ 340
52600	NU 2300+HJ 2300	52632	NU 2300+HJ 2332
62000 type Cylindrical roller bearing inner ring with single flange and separate thrust collar			
62200	NJ 200+HJ 200	62218	NJ 200+HJ 218
62300	NJ 300+HJ 300	62322	NJ 300+HJ 322
62400	NJ 400+HJ 400	62419	NJ 400+HJ 419
62600	NJ 2300+HJ 2300	62613	NJ 2300+HJ 2313
262000 type Cylindrical roller bearing outer ring with snap groove, inner ring with single flange.			
4262900	NJ 4900 N	4262992	NJ 4992 N
262300	NJ 300 N	262314 E	NJ 314 N
92000 type Cylindrical roller bearing inner ring with single flange and loose rib			
1092900	NUP 1900	10929/710	NUP 19/710
92100	NUP 1000	92154	NUP 1054
92200	NUP 200	92232	NUP 232
92300	NUP 300	92328	NUP 328
92400	NUP 400	92417	NUP 417
92500	NUP 2200	92513	NUP 2213
92600	NUP 2300	92626	NUP 2326

"2" Cylindrical roller bearing

Series		Example	
Old designation	New Designation	Old designation	New Designation
192000 type Cylindrical roller bearing outer ring with snap groove, inner ring with single flange and loose rib			
192200	NUP 2200 N	192213	NUP 2213 N
192300	NUP 300 N	192314	NUP 314 N
102000 type Cylindrical roller bearing outer ring without flange inner ring with double			
102100	NCL 1000	102110	NCL 1010
202000 type Cylindrical roller bearing outer ring without flange have snap groove			
3202700	N 3200 N	3202776	N 3276 N
3202200	N 3200 N	3202244	N 3244 N
202300	N 300 N	202330 EH	N 330 N
292000 type Cylindrical roller bearing without inner ring			
1292900	RNU 1900	1292934	RNU 1934
292100	RNU 1000	292136	RNU 1036
292200	RNU 200	292224	RNU 224
292300	RNU 300	292320	RNU 320
292500	RNU 2200	292518	RNU 2218
292600	RNU 2300	292615	RNU 2315
392000 type Cylindrical roller bearing outer ring with double flange and snap groove but without inner ring			
392200	RNU 200 N	392224	RNU 224 N
392300	RNU 300 N	392322	RNU 322 N
392600	RNU 2300 N	392620	RNU 2320 N
402000 type Cylindrical roller bearing with wide outer ring and single flange.			
402300	NF 300 WC	402310	NF 310 WC
502000 type Cylindrical roller bearing without outer ring.			
502100	RN 1000	502118	RN 1018
502200	RN 200	502222	RN 222
502300	RN 300	502330	RN 330
502400	RN 400	502408	RN 408
502600	RN 2300	502606	RN 2306

Bearing Appendix

"2" Cylindrical roller bearing

Series		Example	
Old designation	New Designation	Old designation	New Designation
372000 type Cylindrical roller bearing outer ring with double snap groove double end sealed double inner ring without cage.			
5372100	NNF 5000-2LSNV	5372126 NNF	5026-2LSNV
472000 type Double-row cylindrical roller bearing inner ring without flange roller arrangement in parallel			
4472900	NU 4900 A	4472992 H	NU 4992 A
182000 type Double-row cylindrical roller bearing with tapered bore.			
3182900	NN 3900 K	3182980	NN 3980 K
4182900	NN 4900 K	4182952	NN 4952 K
3182100	NN 3000 K	3182117	NN 3017 K
62000 type Cylindrical roller bearing inner ring with single flange and separate thrust collar			
62200	NJ 200+HJ 200	62218	NJ 200+HJ 218
62300	NJ 300+HJ 300	62322	NJ 300+HJ 322
62400	NJ 400+HJ 400	62419	NJ 400+HJ 419
62600	NJ 2300+HJ 2300	62613	NJ 2300+HJ 2313
282000 type Double-row cylindrical roller bearing			
3282900	NN 3900	32829/560	NN 39/560
3282100	NN 3000	3282140	NN 3040
482000 type Double-row cylindrical roller bearing inner ring without flange tapered bore.			
3482100	NNU 3000	3482124	NNU 3024
4482100	NNU 4000	4482120	NNU 4020
4482900	NNU 4900	4482932	NNU 4932

"3" Spherical roller bearing

Series		Example	
Old designation	New Designation	Old designation	New Designation
53000 type symmetrical roller type spherical roller bearing			
3053900	23900	3053956	23956
3053100	23000	3053140	23040
4053100	24000	4053184 K	24084/W33
3053700	23100	3053740	23140
4053700	24100	4053756	24156
3053200	23200	3053230	23230
53300	21300	53317	21317
53500	22200	53522	22222
53600	22300	53624	22324
153000 type symmetrical roller tapered bore spherical roller bearing			
3153100	23000	3153126	23026
3153200	23200	3153284	23284
153500	22200	153524	22224
153600	22300	153616	22316
153300	21300	153322	21322
3153700	23100	3153776	23176
453000 type symmetrical roller type tapered bore (1:30) spherical roller bearing			
4453700	24100 K30	4453772 K	24172 K30/W33
4453100	24000 K30	4453176 K	24076 K30/W33

"6" Angular contact ball bearing

Series		Example	
Old designation	New Designation	Old designation	New Designation
36000 type Angular contact ball bearing (nominal contact angle =15°)			
36100	7000 C	36126	7029 C
36200	7200 C	36219	7219 C
36300	7300 C	36318	7318 C
36400	7400 C	36409	7409 C

Bearing Appendix

"6" Angular contact ball bearing

Series		Example	
Old designation	New Designation	Old designation	New Designation
46000 type Angular contact ball bearing (nominal contact angle =25°)			
46100	7000 AC	46140	7040 AC
46200	7200 AC	46220	7220 AC
46300	7300 AC	46319	7319 AC
46400	7400 AC	46416	7416 AC
66000 type Angular contact ball bearing (nominal contact angle =40°)			
66100	7000 B	66118	7018 B
66200	7200 B	66207	7207 B
66300	7300 B	66324	7324 B
66400	7400 B	66412	7412 B
116000 type Four-point contact ball bearing with split outer ring			
116100	QJF 000	116134	QJF 034
116200	QJF 200	116240	QJF 240
116300	QJF 300	116330	QJF 330
176000 type Four-point contact ball bearing with split inner ring			
176100	QJ 000	176136	QJ 036
176200	QJ 200	176222	QJ 222
176300	QJ 300	176317	QJ 317
276000 type Three-point contact ball bearing with split inner ring			
276200	QJS 200	276214L	QJS 214
276300	QJS 300	276308	QJS 308
136000 type Angular contact ball bearing lock catch on the inner ring (nominal contact angle =15°)			
136100	B7000 C	136108	B7008 C
136200	B7200 C	136205	B7205 C
136300	B7300 C	136318	B7318 C
146000 type Angular contact ball bearing lock catch on the inner ring (nominal contact angle =25°)			
146100	B7000 AC	146122J	B7022 AC
146200	B7200 AC	146234	B7234 AC
146300	B7300 AC	146313	B7313 AC

"6" Angular contact ball bearing

Series		Example	
Old designation	New Designation	Old designation	New Designation
166000 type Angular contact ball bearing lock catch on the inner ring (nominal contact angle =40°)			
166200	B7200 B	166203	B7203 B
166300	B7300 B	166322	B7322 B
426000 type Angular contact ball bearing without cage			
1426800	71800 BV	1426816	71816 BV
7426800	7800 BV	7426819	7819 BV
236000 type Angular contact ball bearing back-to-back paired arrangement (nominal contact angle =15°)			
236100	7000 C/DB	236108	7008 C/DB
236200	7200 C/DB	236214	7214 C/DB
236300	7300 C/DB	236309	7309 C/DB
246000 type Angular contact ball bearing back-to-back paired arrangement (nominal contact angle =25°)			
246100	7000 AC/DB	246130	7030 AC/DB
246200	7200 AC/DB	246220	7220 AC/DB
246300	7300 AC/DB	246322	7322 AC/DB
246400	7400 AC/DB	246407J	7407 AC/DB
266000 type Angular contact ball bearing back-to-back paired arrangement(nominal contact angle =40°)			
266300	7300 B/DF	266311	7311 B/DB
336000 type Angular contact ball bearing face-to-face paired arrangement (nominal contact angle =15°)			
336200	7200 C/DF	336240	7240 C/DF
336300	7300 C/DF	336310	7310 C/DF
346000 type Angular contact ball bearing face-to-face paired arrangement (nominal contact angle =25°)			
346100	7000 AC/DF	346120	7020 AC/DF
346200	7200 AC/DF	346240	7240 AC/DF
346300	7300 AC/DF	346330	7330 AC/DF
366000 type Angular contact ball bearing face-to-face paired arrangement (nominal contact angle =40°)			
366300	7300B/DF	366310	7310 B/DF

Bearing Appendix

"6" Angular contact ball bearing

Series		Example	
Old designation	New Designation	Old designation	New Designation
436000 type Angular contact ball bearing tandem paired arrangement (nominal contact angle =15°).			
436100	7000 C/DT	436120	7020 C/DT
436200	7200 C/DT	436214	7214 C/DT
436300	7300 C/DT	436307	7307 C/DT
446000 type Angular contact ball bearing tandem paired arrangement (nominal contact angle =25°).			
446100	7000 AC/DT	446113	7013 AC/DT
446200	7200 AC/DT	446210	7210 AC/DT
446300	7300 AC/DT	446328	7328 AC/DT
466000 type Angular contact ball bearing tandem paired arrangement (nominal contact angle =45°).			
466300	7300 B/DT	466336	7336 B/DT
546000 type Angular contact ball bearing back-to back paired arrangement lock catch on the inner ring(nominal contact angle =25°).			
546300	B7300 AC/DB	546322H	B7322 AC/DB
736000 type Angular contact ball bearing tandem paired arrangement lock catch on the inner ring (nominal contact angle =15°).			
736100	B7000 C/DT	736106	B7006C/DT
836000 type Angular contact ball bearing with triple set tandem arrangement (nominal contact angle =15°).			
836200	7200 C/TT	836207	7207 C/TT
56000 type Double-row angular contact ball bearing with ball filling slot.(nominal contact angle =25°).			
3056200	3056200	3056209	3209
3056300	3056300	3056316	3316
86000, 286000 type Double inner ring double-row angular-contact ball bearing.			
3086200	3200 D	3086215	3215 D
3086300	3300 D	3086315	3315 D
3286300	3300 D	3286307	3307 D

"7" Tapered roller bearing

Series		Example	
Old designation	New Designation	Old designation	New Designation
7000 type Tapered roller bearing			
1007700	31700	1007760	31760
3007700	33100	3007718	33118
1007800	31800	10078/850	318/850
1007900	31900	1007996	31996
2007900	32900	2007952	32952
2007100	32000	2007134	32034
3007100	33000	3007119	33019
7200	30200	7236	30236
3007200	33200	3007213	33213
7300	30300	7352	30352
7500	32200	7532	32232
7600	32300	7626	32326
27000 type Steep angle tapered roller bearing			
27300	31300	27317	31317
67000 type Tapered roller bearing outer ring with cup flange			
7067800	30800R	70678/800	308/800R
67500	32200R	67518	32218R
97000 type Double-row tapered roller bearing with double inner ring			
1097900	351900	10979/1200	3519/1200
2097900	352900	2097930	352930
97100	351000	97172	351072
2097100	352000	2097136	352036
1097700	351100	1097760	351160
2097700	352100	2097752	352152
97200	350200	97210	350210
97500	352200	97536	352236
87000 type Double-row tapered roller bearing tandem arrangement with double outer ring			
87500	372200	87518	372218

Bearing Appendix

"7" Tapered roller bearing

Series		Example	
Old designation	New Designation	Old designation	New Designation
77000 type Four-row tapered roller bearing			
1077900	381900	1077992	381992
2077900	382900	2077930	382930
77100	381000	771/600	3810/600
2077100	382000	2077148	382048
1077700	381100	1077772	381172

"8" Thrust ball bearing

Series		Example	
Old designation	New Designation	Old designation	New Designation
8000 type Thrust ball bearing			
8100	51100	8128	51128
8200	51200	8252	51252
8300	51300	8338	51338
8400	51400	8430	51430
708000 type Thrust ball bearing without cage			
7708100	57100 V	7708172	57172 V
9708100	59100 V	97081/750	591/750 V
18000 type Thrust ball bearing with aligning washer			
18200	53200 U	18230	53230 U
18300	53300 U	18330	53330 U
18400	53400 U	18430	53430 U
28000 type Thrust ball bearing with aligning housing washer			
28300	53300	28320	53320
28400	53400	28417	53417

"8" Thrust ball bearing

Series		Example	
Old designation	New Designation	Old designation	New Designation
168000 type Thrust angular contact ball bearing			
1168900	561000	11689/900	5610/900
168100	561100	1681/800	5611/800
9168200	569200	91682/530	5692/530
9168300	569300	9168306	569306
9168400	569400	9168406	569406
268000 type Double direction thrust angular contact ball bearing			
2268100	234400	2268134	234434
108000 type Thrust ball bearing without shaft washer			
108100	KOW-51100	108107	KOW-51107
38000 type Double direction thrust ball bearing			
38200	52200	38240	52240
38300	52300	38322	52322
38400	52400	38430	52430
48000 type Double direction thrust ball bearing with aligning washer			
48200	54200 U	48226	54226 U
48300	54300 U	48324	54324 U
58000 type Double direction thrust ball bearing with spherical housing washer			
58300	54300	58320	54320

"9" thrust roller bearing

Series		Example	
Old designation	New Designation	Old designation	New Designation
9000 type Cylindrical roller thrust bearing			
9009100	89100	9009107	89107
9100	81100	9124	81124
9200	81200	9226	81226

Bearing Appendix

"9" thrust roller bearing

Series		Example	
Old designation	New Designation	Old designation	New Designation
209000 type Cylindrical roller thrust bearing without housing washer			
209100	KIW-81100	209130	KIW-81130
19000 type Thrust tapered roller bearing			
9019400	99400	9019456	99456
39000 type Thrust spherical roller bearing			
9039200	29200	90392/630	292/630
9039300	29300	9039330	29330
9039400	29400	9039434	29434
549000 type Double row thrust cylindrical roller bearing.			
7549100	87100	75491/1180	871/180
549100	81100 A	549/1800	811/1800 A
7549200	87200	75492/900	872/900
9549200	89200	9549272 H	89272
9549300	89300	9549320	89320

Inch-mm Conversion Table

inch	0	1	2	3	4	5	6	7	8	9	10	
Fraction	Decimal	mm										
1/8	0.125000	3.175	28.575	53.975	53.975	104.775	130.175	155.575	180.975	206.375	231.775	257.175
9/64	0.140625	3.572	28.972	54.372	54.372	105.172	130.572	155.972	181.372	206.772	232.172	257.572
5/32	0.156250	3.969	29.369	54.769	54.769	105.569	130.969	156.369	181.769	207.169	232.569	257.969
11/64	0.171875	4.366	29.766	55.166	55.166	105.966	131.366	156.766	182.166	207.566	232.966	258.366
3/16	0.187500	4.762	30.162	55.562	55.562	106.362	131.762	157.162	182.562	207.962	233.362	258.762
13/64	0.203125	5.159	30.559	55.959	55.959	106.759	132.159	157.559	182.959	208.359	233.759	259.159
7/32	0.218750	5.556	30.956	56.356	56.356	107.156	132.556	157.956	183.356	208.756	234.156	259.556
15/64	0.234375	5.953	31.353	56.753	56.753	107.553	132.953	158.353	183.753	209.153	234.553	259.953
1/4	0.250000	6.350	31.750	57.150	57.150	107.950	133.350	158.750	184.150	209.550	234.950	260.350
17/64	0.265625	6.747	32.147	57.547	57.547	108.347	133.747	159.147	184.547	209.947	235.347	260.747
9/32	0.281250	7.144	32.544	57.944	57.944	108.744	134.144	159.544	184.944	210.344	235.744	261.144
19/64	0.296875	7.541	32.941	58.341	58.341	109.141	134.541	159.941	185.341	210.741	236.141	261.541
5/16	0.312500	7.938	33.338	58.738	58.738	109.538	134.938	160.338	185.738	211.138	236.538	261.938
21/64	0.328125	8.334	33.734	59.134	59.134	109.934	135.334	160.734	186.134	211.534	236.934	262.334
13/32	0.343750	8.731	34.131	59.531	59.531	110.331	135.731	161.131	186.531	211.931	237.331	262.731
23/64	0.359375	9.128	34.528	59.928	59.928	110.728	136.128	161.528	186.928	212.328	237.728	263.128

Inch-mm Conversion Table

inch	0	1	2	3	4	5	6	7	8	9	10	
Fraction	Decimal	mm										
0	0.000000	0.000	25.400	50.800	76.200	101.600	127.000	152.400	177.800	203.200	228.600	254.000
1/64	0.015625	0.397	25.797	51.197	76.597	101.997	127.397	152.797	178.197	203.597	228.997	254.397
1/32	0.031250	0.794	26.194	51.594	76.994	102.394	127.794	153.194	178.594	203.994	229.394	254.794
3/64	0.046875	0.191	26.591	51.991	77.391	102.791	128.191	153.591	178.991	204.391	229.791	255.191
1/16	0.062500	1.588	26.988	52.388	77.788	103.188	128.588	153.988	179.388	204.788	230.188	255.588
5/64	0.078125	1.984	27.384	52.784	78.184	103.584	128.984	154.384	179.784	205.184	230.584	255.984
3/32	0.093750	2.381	27.781	53.181	78.581	103.981	129.381	154.781	180.181	205.581	230.981	256.381
7/64	0.109375	2.778	28.178	53.578	78.978	104.378	129.778	155.178	180.578	205.978	231.378	256.778

inch	0	1	2	3	4	5	6	7	8	9	10	
Fraction	Decimal	mm										
3/8	0.375000	9.525	34.925	60.325	85.725	111.125	136.525	161.925	187.325	212.725	238.125	263.525
25/64	0.390625	9.922	35.322	60.722	86.122	111.522	136.922	162.322	187.722	213.122	238.522	263.922
13/32	0.406250	10.319	35.719	61.119	86.519	111.919	137.319	162.719	188.119	213.519	238.919	264.319
27/64	0.421875	10.716	36.116	61.516	86.916	112.316	137.716	163.116	188.516	213.916	239.316	264.716
7/16	0.437500	11.112	36.512	61.912	87.312	112.712	138.112	163.512	188.912	214.312	239.712	256.112
29/64	0.453125	11.509	36.909	62.309	87.709	113.109	138.509	163.909	189.309	214.709	240.109	265.509
15/32	0.468750	11.906	37.306	62.706	88.106	113.506	138.906	164.306	189.706	215.106	240.506	265.906
31/64	0.484375	12.303	37.703	63.103	88.503	113.903	139.303	164.703	190.103	215.503	240.903	266.303

Bearing Appendix

Inch-mm Conversion Table

inch	0	1	2	3	4	5	6	7	8	9	10	
Fraction	Decimal	mm										
1/2	0.50000	12.700	12.700	63.500	88.900	114.300	139.700	165.100	190.500	215.900	241.300	266.700
33/64	0.515625	13.097	13.097	63.897	89.297	114.697	140.097	165.497	190.897	216.297	241.697	267.097
17/32	0.531250	13.494	13.494	64.294	89.694	115.094	140.494	165.894	191.294	216.694	242.094	267.494
35/64	0.546875	13.891	13.891	64.691	90.091	115.491	140.891	166.291	191.691	217.091	242.491	267.891
5/8	0.625000	15.875	15.875	66.675	92.075	117.475	142.875	168.275	193.675	219.075	244.475	269.875
41/64	0.640625	16.272	16.272	67.072	92.472	117.872	143.272	168.672	194.072	219.472	244.872	270.272
21/32	0.656250	16.669	16.669	67.469	92.869	118.269	143.669	169.069	194.469	219.869	245.269	270.669
43/64	0.671875	17.066	17.066	67.866	93.266	118.666	144.066	169.466	194.866	220.266	245.666	271.066
11/16	0.687500	17.462	17.462	68.262	93.662	119.062	144.462	169.862	195.262	220.662	246.062	271.462
45/64	0.703125	17.859	17.859	68.659	94.059	119.459	144.859	170.259	195.659	221.059	246.459	271.859
23/32	0.718750	18.256	18.256	69.056	94.456	119.856	145.256	170.656	196.056	221.456	246.856	272.256
47/64	0.734375	18.653	18.653	69.453	94.853	120.253	145.653	171.053	196.453	221.853	247.253	272.653
3/4	0.750000	19.050	19.050	69.850	95.250	120.650	146.050	171.450	196.850	222.250	247.650	273.050
49/64	0.765625	19.447	19.447	70.247	95.647	121.047	146.447	171.847	197.247	222.647	248.047	273.447
25/32	0.781250	19.844	19.844	70.644	96.044	121.444	146.844	172.244	197.644	223.044	248.444	273.844
51/64	0.796875	20.241	20.241	71.041	96.441	121.841	147.241	172.641	198.041	223.441	248.841	274.241
13/16	0.812500	20.638	20.638	71.438	96.838	122.238	147.638	173.038	198.438	223.838	249.238	274.638
53/64	0.828125	21.034	21.034	71.834	97.234	122.634	148.034	173.434	198.834	224.234	249.634	275.034
27/32	0.843750	21.431	21.431	72.231	97.631	123.031	148.431	173.831	199.231	224.631	250.031	275.431
55/64	0.859375	21.828	21.828	72.628	98.028	123.428	148.828	174.228	199.628	225.028	250.428	275.828
7/8	0.875000	22.225	22.225	73.025	98.425	123.825	149.225	174.625	200.025	225.425	250.825	276.225
57/64	0.890625	22.622	22.622	73.422	98.822	124.222	149.622	175.022	200.422	225.822	251.222	276.622
29/32	0.906250	23.019	23.019	73.819	99.219	124.619	150.019	175.419	200.819	226.219	251.619	277.019
59/64	0.921875	23.416	23.416	74.216	99.616	125.016	150.416	175.816	201.216	226.616	252.016	277.416
15/16	0.937500	23.812	23.812	74.612	100.012	125.412	150.812	176.212	201.612	227.012	252.412	277.812
61/64	0.953125	24.209	24.209	75.009	100.409	125.809	151.209	176.609	202.009	227.409	252.809	278.209
31/32	0.968750	24.606	24.606	75.406	100.806	126.206	151.606	177.006	202.406	227.806	253.206	278.606
63/64	0.984375	25.003	25.003	75.803	101.203	126.603	152.003	177.403	202.803	228.203	253.603	279.003

inch	11	12	13	14	15	16	17	18	19	20	
Fraction	Decimal	mm									
0	0.0000	279.400	304.800	330.200	355.600	381.000	406.400	431.800	457.200	482.600	508.000
1/16	0.0625	280.988	306.388	331.788	357.188	382.588	407.988	433.388	458.788	484.188	509.588
1/8	0.1250	282.575	307.975	333.375	358.775	384.175	409.575	434.975	460.375	485.775	511.175
3/16	0.1875	284.162	309.562	334.962	360.362	385.762	411.162	436.562	461.962	487.362	512.762
1/4	0.2500	285.750	311.150	336.550	361.950	387.350	412.750	438.150	463.550	488.950	514.350
5/16	0.3125	287.338	312.738	338.138	363.538	388.938	414.338	439.738	465.138	490.538	515.938
3/8	0.3750	288.925	314.325	339.725	365.125	390.525	415.925	441.325	466.725	492.125	517.525
7/16	0.4375	290.512	315.912	341.312	366.712	392.112	417.512	442.912	468.312	493.712	519.112
1/2	0.5000	292.100	317.500	342.900	368.300	393.700	419.100	444.500	469.900	495.300	520.700
9/16	0.5625	293.688	319.088	344.488	369.888	395.288	420.688	446.088	471.488	496.888	522.288
5/8	0.6250	295.275	320.675	346.075	371.475	396.875	422.275	447.675	473.075	498.475	523.875
11/16	0.6875	296.862	322.262	347.662	373.062	398.462	423.862	449.262	474.662	500.062	525.462
3/4	0.7500	298.450	323.850	349.250	374.650	400.050	425.450	450.850	476.250	501.650	527.050
13/16	0.8125	300.038	325.438	350.838	376.238	401.638	427.038	452.438	477.838	503.238	528.638
7/8	0.8750	301.625	327.025	352.425	377.825	403.225	428.625	454.025	479.425	504.825	530.225
15/16	0.9375	303.212	328.612	354.012	379.412	404.812	430.212	455.612	481.012	506.412	531.812

inch	21	22	23	24	25	26	27	28	29	30	
Fraction	Decimal	mm									
0	0.0000	533.400	558.800	584.200	609.600	635.000	660.400	685.800	711.200	736.600	762.000
1/16	0.0625	534.988	560.388	585.788	611.188	636.588	661.988	687.388	712.788	738.188	763.588
1/8	0.1250	536.575	561.975	587.375	612.775	638.175	663.575	688.975	714.375	739.775	765.175
3/16	0.1875	538.162	563.562	588.962	614.362	639.762	665.162	690.562	715.962	741.362	766.762
1/4	0.2500	539.750	565.150	590.550	615.950	641.350	666.750	692.150	717.550	742.950	768.350
5/16	0.3125	541.338	566.738	592.138	617.538	642.938	668.338	693.738	719.138	744.538	769.938
3/8	0.3750	542.925	568.325	593.725	619.125	644.525	669.925	695.325	720.725	746.125	771.525
7/16	0.4375	544.512	569.912	595.312	620.712	646.112	671.512	696.912	722.312	747.712	773.112
1/2	0.5000	546.100	571.500	596.900	622.300	647.700	673.100	698.500	723.900	749.300	774.700
9/16	0.5625	547.688	573.088	598.488	623.888	649.288	674.688	700.088	725.488	750.888	776.288
5/8	0.6250	549.275	574.675	600.075	625.475	650.875	676.275	701.675	727.075	752.475	777.875
11/16	0.6875	550.862	576.262	601.662	627.062	652.462	677.862	703.262	728.662	754.062	779.462
3/4	0.7500	552.450	577.850	603.250	628.650	654.050	679.450	704.850	730.250	755.650	781.050
13/16	0.8125	554.038	579.438	604.838	630.238	655.638	681.038	706.438	731.838	757.238	782.638
7/8	0.8750	555.625	581.025	606.425	631.825	657.225	682.625	708.025	733.425	758.825	784.225
15/16	0.9375	557.212	582.612	608.012	633.412	658.812	684.212	709.612	735.012	760.412	785.812

Inch-mm Conversion Table

inch		31	32	33	34	35	36	37	38	39	40
Fraction	Decimal	mm									
0	0.0000	787.400	812.800	838.200	863.600	889.000	914.400	939.800	965.200	990.600	1016.000
1/16	0.0625	788.988	814.388	839.788	865.188	890.588	915.988	941.388	966.788	992.188	1017.588
1/8	0.1250	790.575	815.975	841.375	866.775	892.175	917.575	942.975	968.375	993.775	1019.175
3/16	0.1875	792.162	817.562	842.962	868.362	893.762	919.162	944.562	969.962	995.362	1020.762
1/4	0.2500	793.750	819.150	844.550	869.950	895.350	920.750	946.150	971.550	996.950	1022.350
5/16	0.3125	795.338	820.738	846.138	871.538	896.938	922.338	947.738	973.138	998.538	1023.938
3/8	0.3750	796.925	822.325	847.725	873.125	898.525	923.925	949.325	974.725	1000.125	1025.525
7/16	0.4375	798.512	823.912	849.312	874.712	900.112	925.512	950.912	976.312	1001.712	1027.112
1/2	0.5000	800.100	825.500	850.900	876.300	901.700	927.100	952.500	977.900	1003.300	1028.700
9/16	0.5625	801.688	827.088	852.488	877.888	903.288	928.688	954.088	979.488	1004.888	1030.288
5/8	0.6250	803.275	828.675	854.075	879.475	904.875	930.275	955.675	981.075	1006.475	1031.875
11/16	0.6875	804.862	830.262	855.662	881.062	906.462	931.862	957.262	982.662	1008.062	1033.462
3/4	0.7500	806.450	831.850	857.250	882.650	908.050	933.450	958.850	984.250	1009.650	1035.050
13/16	0.8125	808.038	833.438	858.838	884.238	909.638	935.038	960.438	985.838	1011.238	1036.638
7/8	0.8750	809.625	835.025	860.425	885.825	911.225	936.625	962.025	987.425	1012.825	1038.225
15/16	0.9375	811.212	836.612	862.012	887.412	912.812	938.212	963.612	989.012	1014.412	1039.812

Basic Tolerance IT

Basic dimensional classification (mm)	Tolerance Grade																		
	1	2	3	4	5	6	7	8	9	10	11	12	13	14	15	16	17	18	
Over	Under	Value of basic tolerance(um)											Value of basic tolerance(um)						
-	3	0.8	1.2	2	3	4	6	10	14	25	40	60	0.10	0.14	0.26	0.40	0.60	1.00	1.40
3	6	1	1.5	2.5	4	5	8	12	18	30	48	75	0.12	0.18	0.30	0.48	0.75	1.20	1.80
6	10	1	1.5	2.5	4	6	9	15	22	36	58	90	0.15	0.22	0.36	0.58	0.90	1.50	2.20
10	18	1.2	2	3	5	8	11	18	27	43	70	110	0.18	0.27	0.43	0.70	1.10	1.80	2.70
18	30	1.5	2.5	4	6	9	13	21	33	52	84	130	0.21	0.33	0.52	0.84	1.30	2.10	3.30
30	50	1.5	2.5	4	7	11	16	25	39	62	100	160	0.25	0.39	0.62	1.00	1.60	2.50	3.90
50	80	2	3	5	8	13	19	30	46	74	120	190	0.30	0.46	0.74	1.20	1.90	3.00	4.60
80	120	2.5	4	6	10	15	22	35	54	87	140	220	0.35	0.54	0.87	1.40	2.20	3.50	5.40
120	180	3.5	5	8	12	18	25	40	63	100	160	250	0.40	0.63	1.00	1.60	2.50	4.00	6.30
180	250	4.5	7	10	14	20	29	46	72	115	185	290	0.46	0.72	1.15	1.85	2.90	4.60	7.20
250	315	6	8	12	16	23	32	52	81	130	210	320	0.52	0.81	1.30	2.10	3.20	5.20	8.10
315	400	7	9	13	18	25	36	57	89	140	230	360	0.57	0.89	1.40	2.30	3.60	5.70	8.90
400	500	8	10	15	20	27	40	63	97	155	250	400	0.63	0.97	1.55	2.50	4.00	6.30	9.70
500	630	9	11	16	22	30	44	70	110	175	280	440	0.70	1.10	1.75	2.80	4.40	7.00	11.00
630	800	10	13	18	25	35	50	80	125	200	320	500	0.80	1.25	2.00	3.20	5.00	8.00	12.50
800	1000	11	15	21	29	40	56	90	140	230	360	560	0.90	1.40	2.30	3.60	5.60	9.00	14.00
1000	1250	13	18	24	34	46	66	105	165	260	420	660	1.05	1.65	2.60	4.20	6.60	10.50	16.50
1250	1600	15	21	29	40	54	78	125	195	310	500	780	1.25	1.95	3.10	5.00	7.80	12.50	19.50
1600	2000	18	25	35	48	65	92	150	230	370	600	920	1.50	2.30	3.70	6.00	9.20	15.00	23.00
2000	2500	22	30	41	57	77	110	175	280	440	700	1100	1.75	2.80	4.40	7.00	11.00	17.50	28.00
2500	3150	26	36	50	69	93	135	210	330	540	860	1350	2.10	3.30	5.40	8.60	13.50	21.00	33.00

Viscosity Conversion Table

kinematic viscosity mm ² /s	Saybolt universal viscosity SUS(second)		Redwood Viscosity R (second)		Engler viscosity E(°C)
	100°C	210°C	50°C	100°C	
2	32.6	32.8	30.8	31.2	1.14
3	36.0	36.3	33.3	33.7	1.22
4	39.1	39.4	35.9	36.5	1.31
5	42.3	42.6	38.5	39.1	1.40
6	45.5	45.8	41.1	41.7	1.48
7	48.7	49.0	43.7	44.3	1.56
8	52.0	52.4	46.3	47.0	1.65
9	55.4	55.8	49.1	50.0	1.75
10	58.8	59.2	52.1	52.9	1.84
11	62.3	62.7	55.1	56.0	1.93
12	65.9	66.4	58.2	59.1	2.02
13	69.6	70.1	61.4	62.3	2.12
14	73.4	73.9	64.7	65.6	2.22
15	77.2	77.7	68.0	69.1	2.32
16	81.1	81.7	71.5	72.6	2.43
17	85.1	85.7	75.0	76.1	2.54
18	89.2	89.8	78.6	79.7	2.64
19	93.3	94.0	82.1	83.6	2.76
20	97.5	98.2	85.8	87.4	2.87
21	102	102	89.5	91.3	2.98
22	106	107	93.3	95.1	3.10
23	110	111	97.1	98.9	3.22
24	115	115	101	103	3.34
25	119	120	105	107	3.46
26	123	124	109	111	3.58
27	128	129	112	115	3.70
28	132	133	116	119	3.82
29	137	138	120	123	3.95
30	141	142	124	127	4.07
31	145	146	128	131	4.20
32	150	150	132	135	4.32
33	154	155	136	139	4.45
34	159	160	140	143	4.57

Viscosity Conversion Table

kinematic viscosity mm ² /s	Saybolt universal viscosity SUS(second)		Redwood Viscosity R (second)		Engler viscosity E(°C)
	100°C	210°C	50°C	100°C	
35	163	164	144	147	4.70
36	168	170	148	151	4.83
37	172	173	153	155	4.96
38	177	178	156	159	5.08
39	181	183	160	164	5.21
40	186	187	164	168	5.34
41	190	192	168	172	5.47
42	195	196	172	176	5.59
43	199	201	176	180	5.72
44	204	205	180	185	5.85
45	208	210	184	189	5.98
46	213	215	188	193	6.11
47	218	219	193	197	6.24
48	222	224	197	202	6.37
49	227	228	201	206	6.50
50	231	233	205	210	6.63
55	254	256	225	231	7.24
60	277	279	245	252	7.90
65	300	302	266	273	8.55
70	323	326	286	294	9.21
75	346	349	306	315	9.89
80	371	373	326	336	10.5
85	394	397	347	357	11.2
90	417	420	367	378	11.8
95	440	443	387	399	12.5
100	464	467	408	420	13.2
120	556	560	490	504	15.8
140	649	653	571	588	18.4
160	742	747	653	672	21.1
180	834	840	734	755	23.7
200	927	933	816	841	26.3
250	1159	1167	1020	1051	32.9
300	1391	1400	1224	1241	39.5

Rockwell, Vickers and Brinell Hardness Conversion Table

Rockwell Hardness		Superficial Rockwell			Vickers Hardness	Brinell hardness	
HRC	HRA	HR15N	HR30N	HR45N	HV	HB30D	$\frac{d_{10} \cdot 2d_{10}}{4d_{2.5} \text{ mm}}$
70.0	86.6				1037		
69.5	86.3				1017		
69.0	86.1				997		
68.5	85.8				978		
68.0	85.5				959		
67.5	85.2				941		
67.0	85.0				923		
66.5	84.7				906		
66.0	84.4				889		
65.5	84.1				872		
65.0	83.9	92.2	81.3	71.7	856		
64.5	83.6	92.1	81.0	71.2	840		
64.0	83.3	91.9	80.6	70.6	825		
63.5	83.1	91.8	80.2	70.1	810		
63.0	82.8	91.7	79.8	69.5	795		
62.5	82.5	91.5	79.4	69.0	780		
62.0	82.2	91.4	79.0	68.4	766		
61.5	82.0	91.2	78.6	67.9	752		
61.0	81.7	91.0	78.1	67.3	739		
60.5	81.4	90.8	77.7	66.8	726		
60.0	81.2	90.6	77.3	66.2	713		
59.5	80.9	90.4	76.9	65.6	700		
59.0	80.6	90.2	76.5	65.1	688		
58.5	80.3	90.0	76.1	64.5	676		
58.0	80.1	89.8	75.6	63.9	664		
57.5	79.8	89.6	75.2	63.4	653		
57.0	79.5	89.4	74.8	62.8	642		
56.5	79.3	89.1	74.4	62.2	631		
56.0	79.0	88.9	73.9	61.7	620		
55.5	78.7	88.6	73.5	61.1	609		
55.0	78.5	88.4	73.1	60.5	599		
54.5	78.2	88.1	72.6	59.9	589		
54.0	77.9	87.9	72.2	59.4	579		
53.5	77.7	87.6	71.8	58.8	570		

Rockwell, Vickers and Brinell Hardness Conversion Table

Rockwell Hardness		Superficial Rockwell			Vickers Hardness	Brinell hardness	
HRC	HRA	HR15N	HR30N	HR45N	HV	HB30D	$\frac{d_{10} \cdot 2d_{10}}{4d_{2.5} \text{ mm}}$
53.0	77.4	87.4	71.3	58.2	561		
52.5	77.1	87.1	70.9	57.6	551		
52.0	76.9	86.8	70.4	57.1	543		
51.5	76.6	86.6	70.0	56.5	534		
51.0	76.3	86.3	69.5	55.9	525	501	2.73
50.5	76.1	86.0	69.1	55.3	517	494	2.75
50.0	75.8	85.7	68.6	54.7	509	488	2.77
49.5	75.5	85.5	68.2	54.2	501	481	2.79
49.0	75.3	85.2	67.7	53.6	493	474	2.81
48.5	75.0	84.9	67.3	53.0	485	468	2.83
48.0	74.7	84.6	66.8	52.4	478	461	2.85
47.5	74.5	84.3	66.4	51.8	470	455	2.87
47.0	74.2	84.0	65.9	51.2	463	449	2.89
46.5	73.9	83.7	65.5	50.7	456	442	2.91
46.0	73.7	83.5	65.0	50.1	449	436	2.93
45.5	73.4	83.2	64.6	49.5	443	430	2.95
45.0	73.2	82.9	64.1	48.9	436	424	2.97
44.5	72.9	82.6	63.6	48.3	429	418	2.99
44.0	72.6	82.3	63.2	47.7	423	413	3.01
43.5	72.4	82.0	62.7	47.1	417	407	3.03
43.0	72.1	81.7	62.3	46.5	411	401	3.05
42.5	71.8	81.4	61.8	45.9	405	396	3.07
42.0	71.6	81.1	61.3	45.4	399	391	3.09
41.5	71.3	80.8	60.9	44.8	393	385	3.11
41.0	71.1	80.5	60.4	44.2	388	380	3.13
40.5	70.8	80.2	60.0	43.6	382	375	3.15
40.0	70.5	79.9	59.5	43.0	377	370	3.17
39.5	70.3	79.6	59.0	42.4	372	365	3.19
39.0	70.0	79.3	58.6	41.8	367	360	3.21
38.5		79.0	58.1	41.2	362	355	3.24
38.0		78.7	57.6	40.6	357	350	3.26
37.5		78.4	57.2	40.0	352	345	3.28
37.0		78.1	56.7	39.4	347	341	3.30
36.5		77.8	56.2	38.8	342	336	3.32
36.0		77.5	55.8	38.2	338	332	3.34

Rockwell, Vickers and Brinell Hardness Conversion Table

Rockwell Hardness		Superficial Rockwell			Vickers Hardness	Brinell hardness	
HRC	HRA	HR15N	HR30N	HR45N	HV	HB30D	$d_{10} \cdot \frac{2d_{10}}{4d_{2.5} \text{ mm}}$
35.5		77.2	55.3	37.6	333	327	3.37
35.0		77.0	54.8	37.0	329	323	3.39
34.5		76.7	54.4	36.5	324	318	3.41
34.0		76.4	53.9	35.9	320	314	3.43
33.5		76.1	53.4	35.3	316	310	3.46
33.0		75.8	53.0	34.7	312	306	3.48
32.5		75.5	52.5	34.1	308	302	3.50
32.0		75.2	52.0	33.5	304	298	3.52
31.5		74.9	51.6	32.9	300	294	3.54
31.0		74.7	51.1	32.3	296	291	3.56
30.5		74.4	50.6	31.7	292	287	3.59
30.0		74.1	50.2	31.1	289	283	3.61
29.5		73.8	49.7	30.5	285	280	3.63
29.0		73.5	49.2	29.9	281	276	3.65
28.5		73.3	48.7	29.3	278	273	3.67
28.0		73.0	48.3	28.7	274	269	3.70
27.5		72.7	47.8	28.1	271	266	3.72
27.0		72.4	47.3	27.5	268	263	3.74
26.5		72.2	46.9	26.9	264	260	3.76
26.0		71.9	46.4	26.3	261	257	3.78
25.5		71.6	45.9	25.7	258	254	3.80
25.0		71.4	45.5	25.1	255	251	3.83
24.5		71.1	45.0	24.5	252	248	3.85
24.0		70.8	44.5	23.9	249	245	3.87
23.5		70.6	44.0	23.3	246	242	3.89
23.0		70.3	43.6	22.7	243	240	3.91
22.5		70.0	43.1	22.1	240	237	3.93
22.0		69.8	42.6	21.5	237	234	3.95
21.5		69.5	42.2	21.0	234	232	3.97
21.0		69.3	41.7	20.4	231	229	4.00
20.5		69.0	41.2	19.8	229	227	4.02
20.0		68.8	40.7	19.2	226	225	4.03
19.5		68.5	40.3	18.6	223	222	4.05
19.0		68.3	39.8	18.0	221	220	4.07
18.5		68.0	39.3	17.4	218	218	4.09
18.0		67.8	38.9	16.8	216	216	4.11
17.5		67.6	38.4	16.2	214	214	4.13
17.0		67.3	37.9	15.6	211	211	4.15

Conversion Table of Leeb and Rockwell Hardness

Leeb	Rockwell	Leeb	Rockwell	Leeb	Rockwell	Leeb	Rockwell
HLD	HRC	HLD	HRC	HLD	HRC	HLD	HRC
756	54.0	788	57.5	820	60.9	852	64.2
758	54.2	790	57.7	822	61.1	854	64.4
760	54.4	792	58.0	824	61.4	856	64.6
762	54.7	794	58.2	826	61.6	858	64.8
764	54.9	796	58.4	828	61.8	860	65.0
766	55.1	798	58.6	830	62.0	862	65.3
768	55.3	800	58.8	832	62.2	864	65.5
770	55.6	802	59.0	834	62.4	866	65.7
772	55.8	804	59.2	836	62.6	868	65.9
774	56.0	806	59.5	838	62.8	870	66.1
776	56.2	808	59.7	840	63.0	872	66.3
778	56.4	810	59.9	842	63.2	874	66.5
780	56.7	812	60.1	844	63.4	876	66.7
782	56.9	814	60.3	846	63.6	878	66.9
784	57.1	816	60.5	848	63.8	880	67.1
786	57.3	818	60.7	850	64.0	882	67.3

sale@technobearing.ru

TECHNOBEARING.RU

8 (800) 700-72-07



Add.: No.1, Beigongji Street, Wafangdian City, Liaoning Province, China

Tel: +86-411-39118866 39118868 39118878

Fax: +86-411-39118880 39118865

P.C.: 116300

E-mail: export@zwz-bearing.com

Website: www.zwz-bearing.com

[2014]

sale@technobearing.ru

TECHNOBEARING.RU

8 (800) 700-72-07